

# TIME AND FREQUENCY: Theory and Fundamentals

---

Byron E. Blair, Editor

Time and Frequency Division  
Institute for Basic Standards  
National Bureau of Standards  
Boulder, Colorado 80302



---

U.S. DEPARTMENT OF COMMERCE, Frederick B. Dent, *Secretary*  
NATIONAL BUREAU OF STANDARDS, Richard W. Roberts, *Director*

Issued May 1974

**Library of Congress Catalog Number: 73-600299**

**National Bureau of Standards Monograph 140**

**Nat. Bur. Stand. (U.S.), Monogr. 140, 470 pages (May 1974)**

**CODEN: NBSMA6**



---

For sale by the Superintendent of Documents, U.S. Government Printing Office, Washington, D.C. 20402  
(Order by SD Catalog No. C13.44:140). Price \$8.65  
Stock Number 0303-01202

## ABSTRACT

This is a tutorial Monograph describing various aspects of time and frequency (T/F). Included are chapters relating to elemental concepts of precise time and frequency; basic principles of quartz oscillators and atomic frequency standards; historical review, recent progress, and current status of atomic frequency standards; promising areas for developing future primary frequency standards; relevance of frequency standards to other areas of metrology including a unified standard concept; statistics of T/F data analysis coupled with the theory and construction of the NBS atomic time scale; an overview of T/F dissemination techniques; and the standards of T/F in the USA. The Monograph addresses both the specialist in the field as well as those desiring basic information about time and frequency. The authors trace the development and scope of T/F technology, its improvement over periods of decades, its status today, and its possible use, applications, and development in days to come.

Key words: Accuracy; Allan variance; atomic frequency standards; atomic time scales; AT(NBS); BIH; buffer gases; CCIR; clock ensembles; clocks; crystal aging; Cs frequency standard; dissemination techniques; figure of merit; flicker noise; frequency domain; frequency stability; frequency standards; frequency/time metrology; hydrogen maser; leap seconds; Loran-C; magnetic resonance; masers; NBS-III; NBS-5; NBS/USNO time coordination; Omega; optical pumping; precision; quartz crystal oscillators; radio T/F dissemination; Rb frequency standards; satellite T/F dissemination; short-term stability; SI Units; TAI; television T/F dissemination; thallium beam standards; time; time dispersion; time domain; time/frequency statistics; time scale algorithm; time scales; "unified standard"; URSI; USA standard time zones; UTC(NBS); UTC(USNO).

## FOREWORD

It is indeed fitting that a time and frequency Monograph should appear now. The year 1973 marks the 50th Anniversary of the transmission of standard radio frequencies on a regularly announced schedule from WWV at Washington, DC; the 25th Anniversary of time and frequency broadcasts from WWVH in Hawaii; and the 25th Anniversary of the first laboratory operation of an atomic clock (at the National Bureau of Standards, Washington, DC). That the field of time and frequency is slowly emerging as a specialty technology is not surprising in today's world of time-referenced measurements and systems such as those required for navigation and communication. It is paradoxical that time, related centuries ago solely to the daily apparent movement of the sun, water clocks, mechanical instruments, and the like, should be at the center of this complex field. Nevertheless, it is becoming a precise and important scientific discipline, in combination with elements of physics, chemistry, quantum mechanics, electronics, radio propagation, and statistics to form atomic frequency generators, time scales, and varied techniques of dissemination.

The urgent demands of scientific endeavors, requiring precision measurements in the 1950's, led the National Bureau of Standards (NBS) to publish Handbook 77—a three volume publication of *Precision Measurement and Calibration*; one of these volumes—*Electricity and Electronics* contained a small time and frequency section. With the advance in the 1960's of scientific methodology, standards of measures, and complex experimental techniques, NBS published a new series of *Precision Measurement and Calibration* in some eleven volumes—Volume V of this Special Publication 300 was devoted entirely to papers on *Frequency and Time* published in the 1960's. The present Monograph results from recommendations of recent Time and Frequency Division Advisory Panels to publish current information that would be “basic, understandable, and practical.” The Panels were concerned that the gains and utility of time and frequency techniques be made readily available to both new and experienced workers in the field in a tutorial and comprehensible manner. That has been the objective of the authors of this Monograph.

The Institute for Basic Standards (IBS), one of four Institutes of the NBS, is given the following responsibility—it “shall provide the central basis within the United States of a complete and consistent system of physical measurement; coordinate that system with measurement systems of other nations; and furnish essential services leading to accurate and uniform physical measurements throughout the Nation's scientific community, industry, and commerce.”<sup>1</sup> As such, IBS is at the center of the National Measurement System with a primary goal of compatibility among standards; i.e., every user in a measurement system expects to obtain the same value of a measurement based on the same reference, but independent of the means. A person desiring time may listen to WWV by radio, dial the telephone time number, or record a satellite time signal. The degree of accuracy may vary but the information is related to a common source and is compatible.

I should emphasize that the major effort of this work is to describe basic principles and practices; it is of little use to maintain and update measurement standards without publicizing their construction, theory of operation, capabilities, and manner of use. We sincerely hope that this Monograph will become a valuable sourcebook of information to the practicing “time and frequency” specialist as well as to those new in the field seeking an understanding of compatibility among National and International time and frequency standards and time scales, telecommunication/navigation systems, and varied dissemination techniques. It is equally important that the material might stimulate new ideas and applications, which of themselves would broaden the depth and scope of time and frequency technology.

E. Ambler, Director  
Institute for Basic Standards  
National Bureau of Standards  
May 8, 1973

---

<sup>1</sup> U.S. Department of Commerce, Departmental Organizational Order 30-2B, NBS Mission Statements, June 12, 1972 (see ann. 11.A—chap. 11).

## PREFACE

“National Bureau of Standards Time . . . This is radio station WWV, Fort Collins, Colorado broadcasting on internationally allocated standard carrier frequencies of 2.5, 5, 10, 15, 20 and 25 MegaHertz, providing time of day, standard time interval, and other related information . . .”

Behind such periodic radio announcements lie a substantive and state-of-the-art technology which has advanced tremendously the last several decades. It is the objective of this Monograph to give comprehensive pictures of various aspects of time and frequency standards in terms of the past, present and future. As such, we trust it will serve as a tutorial reference book by providing a historical background, the present capabilities, and the future potential of the precise and accurate time-keeping technology.

The subject matter is presented in 11 major chapters of reprinted, updated, and new material authored by staff members of the NBS Time and Frequency Division and several other agencies, such as the U.S. Naval Observatory and the U.S. Army Electronics Command. Chapter 1 describes basic concepts of time, frequency, and time scales including the International Atomic Time (TAI) scale. Following basic time aspects are chapters describing crystal oscillators, fundamental principles of atomic frequency standards, and both the historical development and recent progress in realizing various types of atomic frequency standards. Chapter 5 details improvements in cesium beam standards at the National Bureau of Standards (NBS) including a brief description of the new NBS-5; this frequency standard shows a tentative potential accuracy of 2 parts in  $10^{13}$  which is equivalent to a loss of a second in  $\sim 160,000$  years. (Needless to say, a clock will not run such a length of time. However, the current state of the art today requires  $6\mu\text{s}$  in a year which is the same relative accuracy.)

Next are two chapters which project one's thinking to future possibilities; one of these describes areas of promise for developing tomorrow's primary frequency standards while the second relates frequency standards to areas of metrology which might include a unified standard for frequency, time, and length. Chapter 8 presents basic principles of statistics useful for analyzing time and frequency data and for describing the quality of such measurements. This is followed by a chapter which depicts in detail both the theory and formation of the NBS atomic time scale AT (NBS). AT(NBS) is one of seven inputs to the TAI scale maintained by the Bureau International d'Heure (BIH) in Paris, France.

If a laboratory maintains a state-of-the-art frequency standard and time scale, such standards are of small value unless they can be made available readily to distant users. Chapter 10 describes various dissemination techniques for bridging the gap between a frequency standard and varied classes of time and frequency users. The Monograph concludes with Chapter 11, a joint paper of the NBS and USNO, which depicts the standards of time and frequency in the USA; the chapter details and compares the timekeeping missions and responsibilities of both organizations. By mutual agreement, time at both national laboratories is maintained within about  $\pm 5\mu\text{s}$  of each other. Chapter 11 includes a brief description of international agencies involved with timekeeping responsibilities as well as the Uniform Time Act of 1966 of the USA given in the *U.S. Code*.

There has been an earnest attempt to thoroughly document each chapter with a complete reference listing. In many instances a selected bibliography also has been included to aid a reader seeking additional information in the given subject areas. We have attempted to be consistent and complete in listing the references; journal title abbreviations are those given in the 1961 *Chemical Abstracts—Lists of Publications* or the 1966 *Revised and Enlarged Word Abbreviation List for USAZI Z39.5-1963—American Standard for Periodical Title Abbreviations*. Many of the bibliographic listings can be seen at public or university libraries. NBS Technical Notes and publications with a USGPO notation may be purchased from:

Superintendent of Documents  
U.S. Government Printing Office  
Washington, DC 20402.

References showing an AD or N accession number and a NTIS notation are available at reproduction costs from the National Technical Information Service as follows:

National Technical Information Service  
U.S. Department of Commerce  
5285 Port Royal Road  
Springfield, VA 22150.

Limited reprints of research articles and reports are available usually from individual authors.

We have tried to maintain consistency in the use of symbols or their equivalents in all chapters; definitions are given in the Glossary of Symbols—Annex A of Chapter 8. To aid readers unfamiliar with letter symbols in the time and frequency field, we have added an abbreviation listing which follows the subject index.

A rapidly increasing number of technologies and disciplines are employing time and frequency techniques. Included are areas such as national defense, telecommunications, public safety, electric utilities, navigation, high speed data-computing networks, etc. There are also indications that a large number of systems independently generate and disseminate their own time and frequency information, largely through use of the radio spectrum. We would point out that the radio spectrum might be conserved to a large extent if both communication and navigation systems were designed to include synchronization pulse formats convenient for T/F dissemination without compromising primary system concerns. By the same token, a system designer better can accommodate a frequency dissemination function through referencing system frequencies to recognized national frequency standards and choosing convenient subsystem frequencies where feasible.

The editor wishes to gratefully acknowledge the cooperation and patience of the many authors who have contributed to this Monograph. Considerable help and suggestions were given by Dr. Yardley Beers, Mr. Roger Easton, Mr. Donald Hammond, Dr. Richard Klepsynski, Dr. Allan Mungall, Dr. David Wait, Dr. Bernard Wieder, and many staff members of the Time and Frequency Division. Credit also must be given both to the NBS Visual Information Group for the many distinctive illustrations in this book and to the NOAA Library personnel for help in locating and verifying many reference citations. Last but not least special thanks are due Mrs. Sharon Erickson for her diligence and effort in processing the final copy of this publication.

The authors trust that the Monograph will prove helpful in the understanding of the intriguing and ever changing field of time and frequency; they would welcome suggestions, comments and/or questions about the subject material.

Time moves on; the WWV broadcast proclaims “at the tone \_\_\_ hours, \_\_\_ minutes Greenwich Mean Time.”

Byron E. Blair, Editor  
National Bureau of Standards  
Boulder, Colorado 80302  
April 23, 1973

# Contents

	Page
Abstract.....	III
Foreword.....	IV
Preface.....	V
Ernest Ambler, Director, Institute for Basic Standards, NBS, Washington, DC 20234	
Byron E. Blair, Time and Frequency Division, NBS, Boulder, CO 80302	
CHAPTER 1. BASIC CONCEPTS OF PRECISE TIME AND FREQUENCY.....	1
James A. Barnes, Time and Frequency Division, NBS, Boulder, CO 80302	
Introduction.....	3
Clocks and timekeeping.....	3
Basic concepts of time.....	4
Time scales.....	4
International Atomic Time (TAI) Scale.....	10
The concepts of frequency and time interval.....	10
Uses of time scales.....	11
Conclusions.....	13
References.....	13
Bibliography.....	14
Annex A—Definitions of the second and TAI.....	15
Annex B—Standard frequency and time broadcast agreements.....	29
Annex C—Results of 6th Session of Consultative Committee for Definition of the Second (CCDS).....	37
CHAPTER 2. PART A—STATE OF THE ART—QUARTZ CRYSTAL UNITS AND OSCILLATORS.....	41
Eduard A. Gerber, Electronics Components Laboratory, U.S. Army Electronics Command, Ft. Monmouth, NJ 07703, and Roger A. Sykes, Bell Telephone Laboratories, Inc., Allentown, PA 18103	
Introduction.....	43
Quartz crystal units.....	44
Frequency stability as a function of	
Temperature.....	48
Time (aging).....	48
Stress, vibration and acceleration.....	50
Drive level.....	50
Nuclear effects.....	51
Quartz crystal controlled oscillators.....	52
Conclusions.....	55
References.....	55
PART B—PROGRESS IN THE DEVELOPMENT OF QUARTZ CRYSTAL UNITS AND OSCILLATORS SINCE 1966.....	57
Eduard A. Gerber, Electronics Technology and Devices Laboratory, U.S. Army Electronics Command, Ft. Monmouth, NJ 07703, and Roger A. Sykes, formerly with Bell Telephone Laboratories, Inc., Allentown, PA 18103	
Introduction.....	59
Quartz crystal units.....	59
Frequency stability as a function of	
Temperature.....	60
Time (aging).....	61
Stress, vibration and acceleration.....	61
Drive level.....	61
Quartz crystal controlled oscillators.....	62
Conclusions and possible future developments.....	62
References.....	63
CHAPTER 3. THE PHYSICAL BASIS OF ATOMIC FREQUENCY STANDARDS.....	65
Allan S. Risley, Time and Frequency Division, NBS, Boulder, CO 80302	
Introduction.....	67
Atomic energy levels.....	67
The interaction between atoms and electromagnetic radiation.....	71
Choosing a suitable atom.....	73
The three major examples of atomic frequency standards.....	78
Summary.....	83
References.....	84
Bibliography.....	84
CHAPTER 4. PART A—A HISTORICAL REVIEW OF ATOMIC FREQUENCY STANDARDS.....	85
Roger E. Beehler, Frequency and Time Division, Hewlett-Packard Company, Palo Alto, CA 94304 (now with Time and Frequency Division, NBS, Boulder, CO 80302.)	
Introduction.....	87
Development of basic techniques.....	87
Applications of basic techniques to the development of specific types of atomic frequency standards.....	93
Conclusions.....	99
References.....	99

	Page
PART B—RECENT PROGRESS ON ATOMIC FREQUENCY STANDARDS.....	101
Roger E. Beehler, Time and Frequency Division, NBS, Boulder, CO 80302	
Introduction.....	103
Laboratory cesium standards.....	103
Hydrogen standards.....	105
Commercial cesium standards.....	107
Commercial rubidium standards.....	108
References.....	108
CHAPTER 5. PART A—IMPROVEMENTS IN ATOMIC CESIUM BEAM FREQUENCY STANDARDS AT THE NATIONAL BUREAU OF STANDARDS.....	111
David J. Glaze, Time and Frequency Division, NBS, Boulder, CO 80302	
Introduction.....	113
Modifications to the NBS-III System.....	113
Accuracy capability of NBS-III (1969).....	115
Some immediate goals.....	116
Conclusions.....	116
References.....	117
PART B—THE NEW PRIMARY CESIUM BEAM FREQUENCY STANDARD: NBS-5.....	119
David J. Glaze, Helmut Hellwig, Stephen Jarvis, Jr., Arthur E. Wainwright, and David W. Allan, Time and Frequency Division, NBS, Boulder, CO 80302	
Introduction.....	121
The NBS-5 system.....	121
Preliminary experimental results (status April 1973).....	122
References.....	124
CHAPTER 6. AREAS OF PROMISE FOR THE DEVELOPMENT OF FUTURE PRIMARY FREQUENCY STANDARDS.....	125
Helmut Hellwig, Time and Frequency Division, NBS, Boulder, CO 80302	
Introduction.....	127
Effects on frequency: particle interrogation.....	127
Effects on frequency: particle confinement.....	129
Effects on frequency: particles and particle preparation.....	130
Existing concepts for quantum electronic frequency standards.....	131
Frequency stability for one second averaging.....	133
Accuracy capability.....	133
Conclusions.....	134
References.....	135
CHAPTER 7. ACCURATE FREQUENCY MEASUREMENTS: RELEVANCE TO SOME OTHER AREAS OF METROLOGY.....	137
Helmut Hellwig and Donald Halford, Time and Frequency Division, NBS, Boulder, CO 80302	
Introduction.....	139
Accurate frequency measurements: principles and methods.....	140
Survey of accurate frequency measurements.....	142
Significance and impact of accurate frequency measurements.....	144
Summary.....	145
References.....	146
Selected bibliography: future trends in accurate frequency/time metrology.....	148
CHAPTER 8. STATISTICS OF TIME AND FREQUENCY DATA ANALYSIS.....	151
David W. Allan, John H. Shoaf, and Donald Halford, Time and Frequency Division, NBS, Boulder, CO 80302	
Introduction.....	153
Definitions and fundamentals.....	153
Characterization of frequency stability.....	154
Requirements for a measure of frequency stability.....	155
Concepts of frequency stability.....	156
The definition of measures of frequency stability (Second Monert type).....	156
Translations among frequency stability measures.....	159
Examples of applications of previously developed measures.....	161
Measurement techniques for frequency stability.....	162
Summary of frequency stability measures.....	165
Practical applications of frequency stability specification and measurements.....	165
Terminology for specification of frequency stability.....	165
Comparison of measurement techniques.....	167
Operational systems for measurement of frequency stability at NBS (high frequency region).....	168
Operational systems for measurement of frequency stability at NBS (microwave region).....	171
Conclusions/summary.....	175
References.....	175
Annex A—Glossary of symbols.....	176
Annex B—Translation of data from frequency domain to time domain using the conversion chart (table 8.1).....	178
Annex C—Spectral densities: frequency domain measures of stability.....	178



	Page
Annex D—A sample calculation of script $\mathcal{L}$ .....	180
Annex E—A sample calculation of Allan Variance, $\sigma_y^2(\tau)$ .....	181
Annex F—Computing counter program using an efficient overlapping estimator for $(\sigma_y^2(N=2, T, \tau, f_h))^{1/2}$ .....	182
Annex G—Selected frequency stability references: bibliography.....	182
Annex H—Detailed procedure for calibrating microwave (frequency stability) measurement system .....	187
Annex I—Measurement procedure for determining frequency stability in the microwave region...	188
Annex J—Tables of bias function, $B_1$ and $B_2$ , for variances based on finite samples of processes with power law spectral densities .....	190
Table 8.1—Stability measure conversion chart .....	166
<b>CHAPTER 9. THE NATIONAL BUREAU OF STANDARDS ATOMIC TIME SCALE: GENERATION, STABILITY, ACCURACY, AND ACCESSIBILITY .....</b>	<b>205</b>
David W. Allan, James E. Gray and Howard E. Machlan, Time and Frequency Division, NBS, Boulder, CO 80302	
Introduction.....	207
Basic time and frequency considerations.....	208
Clock modeling.....	208
The AT(NBS) time scale system.....	214
The UTC(NBS) coordinated scale.....	220
UTC(NBS) accessibility.....	221
The International Atomic Time Scale (TAI).....	223
Conclusions.....	223
References.....	224
Annex A—Optimum filters for various noise processes (Eq (9.19)).....	225
Annex B—Time dispersion with recursive filter applied to flicker noise FM.....	226
Annex C—Mini-computer program for first order time scale algorithm .....	227
Annex D—Selected bibliography on time scales and their formation.....	230
<b>CHAPTER 10. TIME AND FREQUENCY DISSEMINATION: AN OVERVIEW OF PRINCIPLES AND TECHNIQUES.....</b>	<b>233</b>
Byron E. Blair, Time and Frequency Division, NBS, Boulder, CO 80302	
Introduction.....	235
Dissemination concepts.....	235
Radio dissemination of time and frequency.....	239
Dissemination of time and frequency via portable clock.....	290
TFD via other means.....	294
T/F user and system evaluation.....	299
Conclusions.....	302
References.....	303
Annex A—Characteristics of radio frequency bands 4 through 10.....	310a
Annex B—Characteristics of standard frequency and time signals in allocated bands.....	311
Annex C—Characteristics of stabilized frequency and time-signal emissions outside allocated frequency assignments.....	312
Annex D—Characteristics of frequency stabilized navigation systems useful for time/frequency comparisons.....	313
<b>CHAPTER 11. THE STANDARDS OF TIME AND FREQUENCY IN THE USA.....</b>	<b>315</b>
James A. Barnes, Time and Frequency Division, NBS, Boulder, CO 80302, and Gernot M. R. Winkler, Time Service Division, USNO, Washington, DC 20390	
Introduction.....	317
Time scales—terms of reference.....	317
Time and frequency (T&F) activities of the National Bureau of Standards and the U.S. Naval Observatory.....	318
International organizations involved in standard time and frequency.....	323
The legal definition of “standard time”.....	325
Summary.....	325
References.....	325
Annex A—NBS enabling legislation.....	329
Annex B—USNO authorizing documents.....	347
Annex C—NBS time and frequency responsibilities.....	359
Annex D—USNO precise time and time interval (PTTI) responsibilities.....	363
Annex E—NBS/USNO time coordination/services.....	377
Annex F—Treaty of the meter.....	385
Annex G—Legal documents concerning “standard time”.....	389
Subject Index.....	415
Time and Frequency Abbreviation Listing.....	458

**CHAPTER 1**  
**BASIC CONCEPTS OF PRECISE TIME AND FREQUENCY\***

**James A. Barnes<sup>†</sup>**

**Contents**

	Page
1.1. Introduction .....	3
1.2. Clocks and Timekeeping.....	3
1.3. Basic Concepts of Time.....	4
1.4. Time Scales .....	4
1.4.1. Universal Time (UT0).....	5
1.4.2. Universal Time 1 (UT1).....	6
1.4.3. Universal Time 2 (UT2).....	6
1.4.4. Ephemeris Time (ET).....	6
1.4.5. Atomic Time (AT).....	7
1.4.6. Coordinated Universal Time (UTC) Prior to 1972.....	8
1.4.7. The New UTC System .....	8
1.4.8. Comparisons of Time Scales .....	9
1.4.8.1. Reliability and Redundancy.....	9
1.5. International Atomic Time (TAI) Scale .....	10
1.6. The Concepts of Frequency and Time Interval.....	10
1.6.1. Time Interval and Time Scales.....	11
1.7. Uses of Time Scales.....	11
1.7.1. Time Scales for Systems Synchronization Uses.....	11
1.7.2. Time Scales for Celestial Navigation and Astronomical Uses.....	11
1.8. Conclusions.....	13
1.9. References .....	13
1.10. Bibliography .....	14
Annex 1.A. Definition of the Second and TAI .....	15
Annex 1.B. Standard Frequency and Time Broadcast Agreements.....	29
Annex 1.C. Results of 6th Session of Consultative Committee for Definition of the Second (CCDS).....	37

---

\*Manuscript received January 9, 1973.

<sup>†</sup>Time and Frequency Division, Institute for Basic Standards, National Bureau of Standards, Boulder, Colorado 80302.

"What is time? The shadow on the dial, the striking of the clock, the running of the sand, day and night, summer and winter, months, years, centuries—these are but arbitrary and outward signs, the measure of time, not time itself . . ."

Longfellow,  
*Hyperion*, Bk. ii, Ch. 6.

This chapter describes some elements of timekeeping and gives basic concepts of time and frequency such as date, time interval, simultaneity and synchronization. This chapter details characteristics of numerous time scales including astronomical, atomic, and compromises of both. The universal time scales are based on the apparent motion of the sun in the sky, while atomic time scales are based on the periodic fluctuations of a radio signal in resonance with a certain species of atoms. The chapter includes a description of the UTC time scale both before and after January 1, 1972, and delineates requirements of an International Atomic Time scale.

**Key words:** Atomic time; clocks; ephemeris time; frequency; navigation/time; TAI scale; time; time interval; time scales; universal time; UTC system.

## 1.1. INTRODUCTION

The measurement of time is a branch of science with a very long history [1, 2, 3].<sup>1</sup> For this reason, it is difficult to understand the current operations of time and frequency measurements without some background. This chapter presents a brief history of the scientific and engineering aspects of time and frequency. The discussion commences with a basic consideration of clocks and concepts involved in time measurements. Time scales are described and delineated as either astronomical, atomic, or compromises thereof. Universal time scales are based on the apparent motion of the sun in the sky, while atomic time scales are related to periodic fluctuations of a radio signal in resonance with a certain species of atoms. This chapter includes a description of the UTC system which commenced January 1, 1972. Characteristics and requirements of an International Atomic Time (TAI)<sup>2</sup> scale indicate that the atomic time scale of the Bureau International de l'Heure (BIH) is a logical choice. However, the TAI scale will not replace some of the needs for astronomical time scales which are necessary for earth position. The reader is referred to Chapter 9 for details of constructing and maintaining an atomic time scale.

## 1.2. CLOCKS AND TIMEKEEPING

In early times, the location of the sun in the sky was the only reliable indication of the time of day. Of course, when the sun was not visible, one was unable to know the time with much precision. People developed devices (called clocks) to interpolate between checks with the sun. The sun was sort of a "master clock" that could be read with the aid of a sundial. An ordinary clock, then, was a device used to interpolate between checks with the sun. The different clock devices form an interesting branch of history; we will not review them to any extent here except to point out their gain in accuracy over a period of years as shown in figure 1.1 and to refer the reader to the works of Ward, Marrison, and Hood [4, 5, 6]. (Timekeeping has shown nearly 10 orders of magnitude improvement within the last 6 centuries with about 6 orders occurring within 70 years of the 20th century.) Thus, a clock could be a "primary clock" like the position of the sun in the sky, or it could be a secondary clock and only interpolate between checks with the primary clock or time standard. Historically, some people have used the word "clock" with the connotation of a secondary time reference but today this usage would be too restrictive.

<sup>1</sup> Figures in brackets indicate the literature references at the end of this chapter.

<sup>2</sup> The 6th Session of the Consultative Committee for the Definition of the Second recommends that International Atomic Time be designed by TAI in all languages (July 1972).

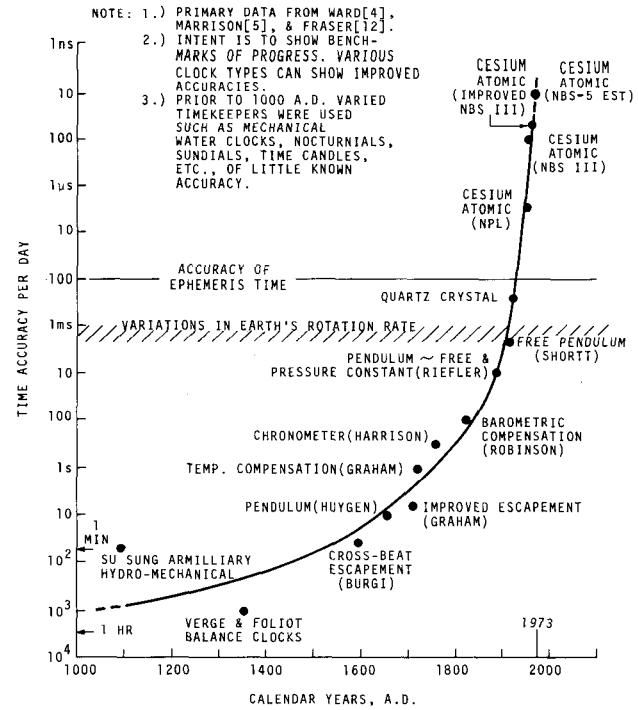

Fig. 1.1. Progress in timekeeping accuracy.

When one thinks of a clock, it is customary to think of some kind of pendulum or balance wheel and a group of gears and a clock face. Each time the pendulum completes a swing, the hands of the clock are moved a precise amount. In effect, the gears and hands of the clock "count" the number of swings of the pendulum. The face of the clock, of course, is not marked off in the number of swings of the pendulum but rather in hours, minutes, and seconds.

One annoying characteristic of pendulum-type clocks is that no two clocks ever keep exactly the same time. This is one reason for looking for a more stable "pendulum" for clocks. In the past, the most stable "pendulums" were found in astronomy. Here one obtains a significant advantage because only one universe exists—at least for observational purposes, and time defined by this means is available to anyone—at least in principle. Thus, one can obtain a very reliable time scale which has the property of universal accessibility. In this chapter, time scale is used to refer to a conceptually distinct method of assigning dates to events.

In a very real sense, the pendulum of ordinary, present-day electric clocks is the electric current supplied by the power company. In the United States the power utilities generally synchronize their generators to the National Bureau of Standards (NBS) low frequency broadcast, WWVB [7]. Thus, the right number of pendulum swings occur each

day. Since all electric clocks which are powered by the same source have, in effect, the same pendulum, these clocks do not gain or lose time relative to each other; i.e., they run at the same rate. Indeed, they will remain fairly close to the time as broadcast by WWVB ( $\pm 5$  seconds) and will maintain the same time difference with respect to each other ( $\pm 1$  millisecond) over long periods of time.

It has been known for some time that atoms have characteristic resonances or, in a loose sense, "characteristic vibrations." The possibility therefore exists of using the "vibrations of atoms" as pendulums for clocks. The study of these "vibrations" has normally been confined to the fields of microwave and optical spectroscopy. Presently, microwave resonances (vibrations) of atoms are the most precisely determined and reproducible physical phenomena that man has encountered. There is ample evidence to show that a clock which uses "vibrating atoms" as a pendulum will generate a time scale more uniform than even its astronomical counterparts [8, 9, 10].

But due to intrinsic errors in any actual clock system, one may find himself back in the position of having clocks which drift relative to other similar clocks. Of course, the rate of drift is much smaller for atomic clocks than the old pendulum clocks, but nonetheless real and important. If at all possible, one would like to gain the attribute of universal accessibility for atomic time also. This can be accomplished only by coordination between laboratories generating atomic time. Both national and international coordination are in order.

### 1.3. BASIC CONCEPTS OF TIME

One can use the word "time" in the sense of date. (By "date" we mean a designated mark or point on a time scale.) One can also consider the concept of time interval or "length" of time between two events. The difference between these concepts of date and time interval is important and has often been confused in the single word "time". This section explores some basic ideas inherent in the various connotations of time.

The *date* of an event on an earth-based time scale is obtained from the number of cycles (and fractions of cycles) of the apparent sun counted from some agreed-upon origin. Similarly, atomic time scales are obtained by counting the cycles of a signal in resonance with certain kinds of atoms. (Several atomic time scales [9] have chosen the "zero point" at zero hours January 1, 1958 (UT-2), but this is not universal among all atomic time scales in existence today.) One of the major differences between these two methods is that the cycles of atomic clocks are much, much shorter than the daily cycles of the apparent sun. Thus, the atomic clock requires more sophisticated devices to count cycles than are

required to count solar days. The importance of this difference is a matter of technological convenience and is not very profound. Of technological significance are the facts that atomic clocks can be read with much greater ease and with many thousands of times the precision of the earth clock. In addition the reading of an atomic clock can be predicted with almost 100,000 times better accuracy than the earth clock.

In the U.S. literature on navigation, satellite tracking, and geodesy, the word "epoch" is sometimes used in a similar manner to the word "date." However, dictionary definitions of epoch show gradations of meanings such as time duration, time instant, a particular time reference point, as well as a geological period of time. Thus, epoch often simultaneously embodies concepts of both date and duration. Because of such considerable ambiguity in the word "epoch,"<sup>3</sup> its use is discouraged in preference to the word "date," the precise meaning of which is neither ambiguous nor in conflict with other, more popular usage. Thus, the date of an event might be: 30 June 1970, 14 h, 35 m, 37.278954 s, UTC, for example, where h, m, s denote hours, minutes, and seconds. (The designation UTC, meaning Universal Time Coordinated, will be discussed later.) On the other hand, "date" should not be interchanged indiscriminately with "epoch" or "time."

Another aspect of time is that of *simultaneity*; i.e., coincidence in time of two events. For example, we might synchronize clocks upon the arrival of portable clocks at a laboratory. Here we introduce an additional term, *synchronization*, which implies that the two clocks are made to have the same reading in some frame of reference. Note that the clocks need not be synchronized to an absolute time scale. As an example, two people who wish to communicate with each other might not be critically interested in the date, they just want to be *synchronized* as to when they use their communications equipment. Many sophisticated electronic navigation systems (and proposed collision avoidance systems) do not depend on accurate dates but they do depend upon very accurate time synchronization. Even ordinary television receivers require accurate time synchronization. We thus see some of the complexities involved in concepts of time and how varied combinations of time aspects are embodied in and influence various time-related activities.

### 1.4. TIME SCALES

A system of assigning dates to events is called a *time scale*. The apparent motion of the sun in the

<sup>3</sup>This suggestion awaits definitive recommendations or statement of terms by parties such as the CCIR Study Group 7, Interim Working Party 7/2 on "Forms of Expression for Use of the Standard-Frequency and Time Signal Service"; International Council of Scientific Unions; and the IEEE Standards Committees, among others.

sky constitutes one of the most familiar time scales but is certainly not the only time scale. Note that to completely specify a date using the motion of the sun as a time scale, one must count days (i.e., make a calendar) from some initially agreed-upon beginning. In addition (depending on accuracy needs) one measures the fractions of a day (i.e., "time of day") in hours, minutes, seconds, and maybe even fractions of seconds. That is, one counts cycles (and even fractions of cycles) of the sun's daily apparent motion around the earth.

There are both astronomical time scales [11] and atomic time scales [9] which can provide a basis for precise synchronization. A sensible use of the unqualified word "time" is the use which embodies all of these various aspects of time scales, time measurement, and even time interval (or duration). This is totally consistent with the dictionary definition of the word. Thus, the study of synchronization would be properly said to belong to the broader study of time in general. Thus, it is not only misleading but wrong to say that "time" is only determined by astronomical means. Indeed, there are many classes of time—astronomical time, biological time, and atomic time, to name a few [12].

Time derived from the apparent position of the sun in the sky is called *apparent solar time*. A sundial can indicate the fractions of cycles (i.e., time of day) directly [13]. Calendars, like the Gregorian Calendar, aid in counting the days and naming them.

Copernicus gave us the idea that the earth spins on its axis and travels around the sun in a nearly circular orbit. This orbit is not exactly circular, however, and, in fact, the earth travels faster when nearer the sun (perihelion) than when further from the sun (aphelion). The details of the earth's orbit and Kepler's law of "equal areas" allows one to see that apparent solar time cannot be a uniform time [14]. There is also an effect due to the inclination of the earth's axis to the plane of its orbit (ecliptic plane). A pictorial diagram of the sun-earth-moon relationships is shown in figure 1.2.

#### 1.4.1. Universal Time (UT0)

It is possible to calculate these orbital and inclination effects and correct apparent solar time to obtain a more uniform time—commonly called mean solar time. This correction from apparent solar time

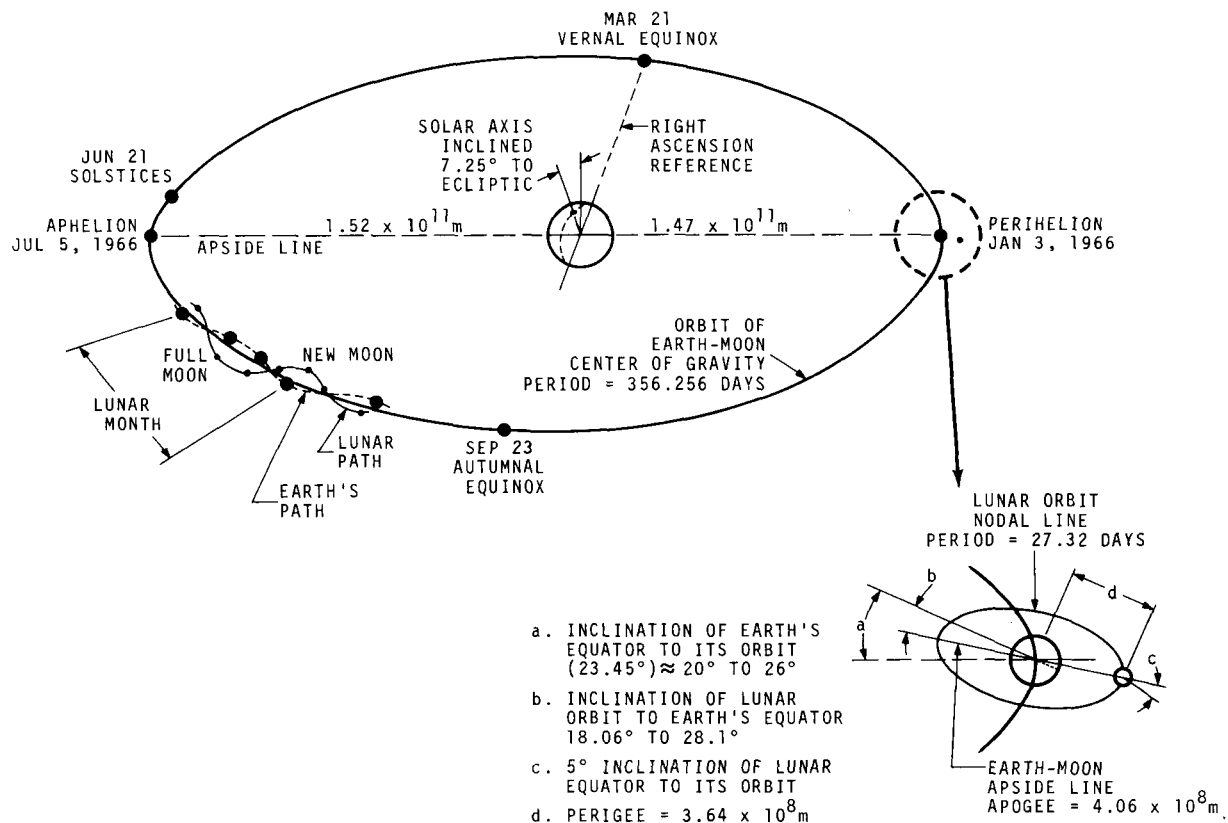

Fig. 1.2. Sun, earth, moon relationships. (Courtesy of A. D. Watt)

to mean solar time is called the Equation of Time and can be found engraved on many present-day sundials [13].

If one considers a distant star instead of our star—the sun—to measure the length of the day, then the earth’s elliptic orbit becomes unimportant and can be neglected. This kind of time is the astronomer’s sidereal time and is generically equivalent to mean solar time since both are based, ultimately, on the spin of the earth on its axis—the second of sidereal time being just enough different to give a sidereal year one more “day” than that of a solar year. In actual practice, astronomers usually observe sidereal time and correct it to get mean solar time. Universal Time (UT0) is equivalent to mean solar time as determined at the Greenwich Meridian, sometimes called Greenwich Mean Time (GMT).

Time, of course, is essential to navigation in determining longitude [15]. In effect, a navigator using a sextant measures the angle between some distant star and the navigator’s zenith as shown in figure 1.3. It is apparent that for a given star there is a locus of points with the same angle. By sighting on another star, a different locus is possible and obviously the position of the navigator is at one of the intersections of the two loci. (A third sighting can remove the ambiguity.) The position of this intersection on the earth obviously depends on the earth’s rotational position. It is important to emphasize that celestial navigation is basically connected to earth position and only to time because the earth also defines a useful time scale.

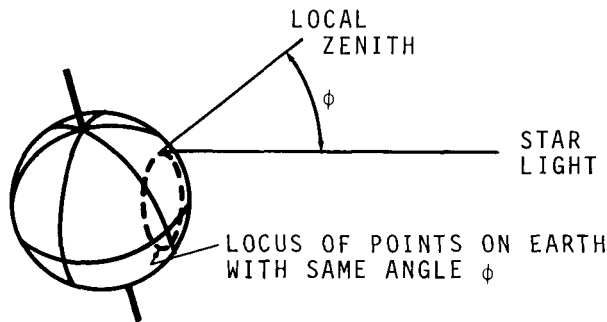

Fig. 1.3. Principle of celestial navigation.

#### 1.4.2. Universal Time 1 (UT1)

In order for the navigator to use the stars for navigation, he must have a means of knowing the earth’s position (i.e., the date on the UT scale). Thus, clocks and sextants together became the means by which navigators could determine their locations. With navigation providing a big market for time and for

good clocks, better clocks were developed, and these began to reveal a discrepancy in Universal Time measured at different locations. The cause of this was traced to the fact that the earth wobbles on its axis; the location of the pole as it intersects the earth’s surface is plotted for 1964–69 in figure 1.4. In effect, one sees the location of the pole wandering over a range of about 15 meters. By comparing astronomical measurements made at various observatories spread over the world, one can correct for this effect and obtain a more uniform time—denoted UT1 [16].

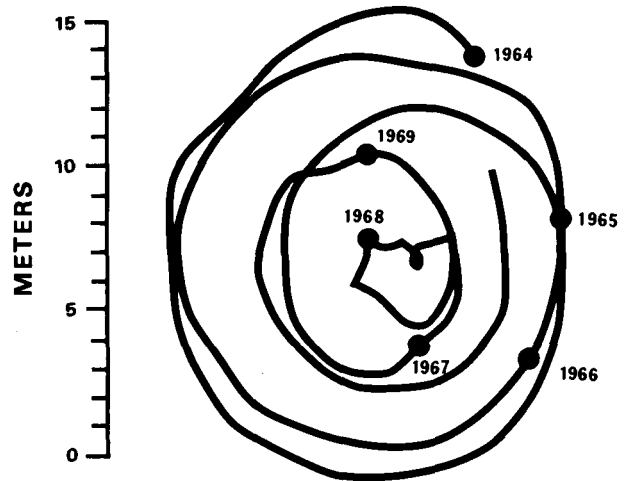

Fig. 1.4. Path of earth’s pole 1964–1969.

#### 1.4.3. Universal Time 2 (UT2)

With the improvement of clocks—both pendulum and quartz crystal—it was discovered several years ago that UT1 had periodic fluctuations (of unknown origin) with periods of one-half year and one year. The natural response was to remove these fluctuations and obtain an even more uniform time—UT2. Thus, there exists a whole family of Universal Times based on the spin of the earth on its axis and various other refinements as diagrammed in figure 1.5. In this historical progression, one notes that UT1 is the true navigator’s scale related to the earth’s angular position. UT2 is a smoothed time and does not reflect the real, periodic variations in the earth’s angular position.

#### 1.4.4. Ephemeris Time (ET)

At this point it is desirable to go back in time—near the turn of the century—and trace some other astronomical studies. In the latter 19th century,

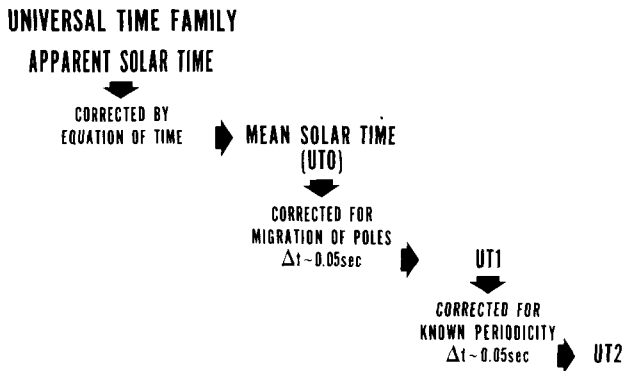

Fig. 1.5. Universal time family interrelationships.

Simon Newcombe compiled a set of tables, based on Newtonian mechanics, which predicted the positions of the sun, the moon, and some planets for the future. A table of this sort is called an *ephemeris*. It was discovered that the predicted positions gradually departed from the observed positions in a fashion too significant to be explained either by observational errors or approximations in the theory. It was noted, however, that if the *time* were somehow in error, all the tables agreed well. At this point it was correctly determined that the rotational rate of the earth was *not* constant. This was later confirmed with quartz clocks and atomic clocks [17, 18, 19]. The astronomers' natural response to this was, in effect, to use Newcombe's tables for the sun in reverse to determine time—actually what is called *Ephemeris Time*. Ephemeris Time is determined by the orbital motion of the earth about the sun (not by rotation of the earth about its own axis) and should not be affected by such things as coremantle slippage or other geometrical changes in the shape of the earth.

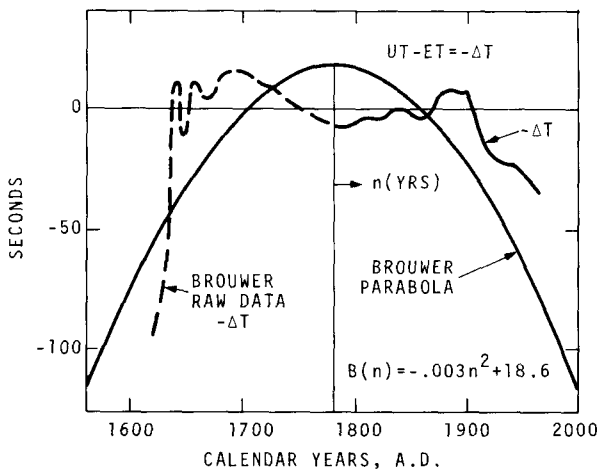

Fig. 1.6. Trend of UT-ET for over three centuries (data from Brouwer [20]).

The variations in UT scales or earth rotation rates have been studied extensively by Brouwer and many others [20, 21, 22]. In this chapter, we need only point out the general nature and size of the variations which have been observed. Brouwer's study covered a long period of time; the curves shown in figure 1.6 summarize much of his data and analysis. They reflect the random behavior [23] of UT, marked on occasion by sudden erratic changes such as seen in 1963 [24]. The abscissas in figure 1.6 are proportional to the astronomical time scale, ET. At present ET can be considered uniform with respect to AT [25] and is a good comparison scale to be used in detecting long-term (gross) properties of a time scale. It is of value to recognize that Brouwer determined that the random processes which affect the rotation of the earth on its axis caused the rms fluctuations in Universal Time to increase as  $t^{3/2}$ , for  $t$  greater than one year. For periods of the order of a year or less it appears that the variations in the UT2 time scale cause the rms fluctuations to increase as the first power of  $t$  (flicker noise frequency modulation) [26]. The coefficient of this linear term is about  $2 \times 10^{-9}$  or almost a factor of  $10^5$  worse than some cesium clocks. The present means of determination of ET are not adequately precise to allow definitive statements about possible systematic variations of ET [11].

#### 1.4.5. Atomic Time (AT)

As was pointed out previously, the date of an event relative to the Universal Time Scale is obtained from the number of cycles (and fractions of cycles) of the apparent sun counted from some agreed-upon origin. (Depending on the need, one may have to apply corrections to obtain UT0, UT1, or UT2.) Similarly, atomic time scales are obtained by counting the cycles of a signal in resonance with certain kinds of atoms.

In the latter part of the 1940's, Harold Lyons at the National Bureau of Standards announced the first Atomic Clock [27]. During the 1950's several laboratories began atomic time scales [28, 29, 30]. The Bureau International de l'Heure (BIH) has been maintaining atomic time for some years now, and this time scale received the official recognition as International Atomic Time (TAI) of the General Conference of Weights and Measures (CGPM) in October 1971 [31] (see ann. 1.A). Beginning 1 January 1972, this atomic time scale has been broadcast (with some modifications) by most countries (see "The new UTC system" in sec. 1.4.7).

In review, we have discussed three broad classes of time scales as illustrated in figure 1.7. The Universal Time family is dependent on the earth's spin on its axis; Ephemeris Time depends on the orbital motion of the earth about the sun; and Atomic Time, which depends on a fundamental property of atoms, is very uniform and precise. Because of the "slow"



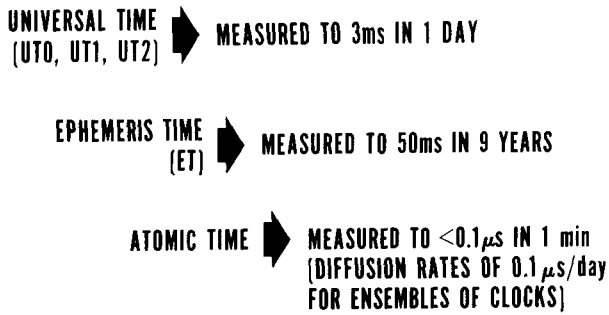

Fig. 1.7. Classes of time scales with typical accuracies.

orbital motion of the earth (1 cycle per year), measurement uncertainties limit the realization of accurate ephemeris time to about 0.05 second for a 9-year average, while UT can be determined to a few thousandths of a second in a day, and AT to a few billionths of a second in a minute or less.

#### 1.4.6. Coordinated Universal Time (UTC) Prior to 1972

From 1960 through 1971 many broadcast time signals (e.g., MSF, WWV, CHU) were based on a time scale called Coordinated Universal Time (UTC) [32]. The rate of a UTC clock was controlled by atomic clocks to be as uniform as possible for 1 year, but this rate could be changed at the first of a calendar year. The yearly rate was chosen by the BIH. Table 1.1 lists the fractional offsets in rate of the UTC scale relative to a pure atomic time scale.

TABLE 1.1. Frequency Offsets of UTC from 1960 to 1972

Year	Offset rate of UTC in parts per $10^{10}$
1960.....	-150
1961.....	-150
1962.....	-130
1963.....	-130
1964.....	-150
1965.....	-150
1966.....	-300
1967.....	-300
1968.....	-300
1969.....	-300
1970.....	-300
1971.....	-300
1972→future.....	0

The minus sign implies that the UTC clock ran slow (in rate) relative to atomic time. The offset in clock rate was chosen to keep the UTC clock in reasonable agreement with UT2. However, one could not exactly predict the earth's rotational rate and discrepancies would accrue. By international agree-

ment [33], UTC was supposed to agree with UT2 to within  $1/10$  second ( $1/20$  second before 1963). On occasion it was necessary to reset the UTC clock by  $1/10$  second ( $1/20$  second before 1963) in order to stay within the specified tolerances as shown in figure 1.8. Also, by international agreement [33], the offsets in clock rate were constrained to be an integral multiple of 5 parts per billion (1 part per billion before 1963). In addition, a few stations (e.g., WWVB) broadcast a Stepped Atomic Time (SAT) signal which was derived directly from an atomic clock (no rate offset) but which was reset periodically (more often than UTC) to maintain SAT within about  $1/10$  second of UT2 [34].

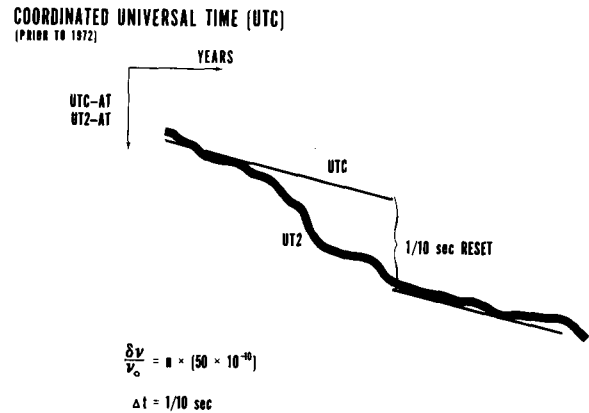

Fig. 1.8. Relationship between UTC and UT2 time scales—prior to 1972.

#### 1.4.7. The New UTC System

The facts that the clock rate of UTC have been offset (see table 1.1) from the correct (atomic) rate and that this offset changed from time to time necessitated actual changes in equipment and often interrupted sophisticated systems. As the needs for reliable synchronization have increased, the old UTC system became too cumbersome. A new compromise system was needed to account better for the ever-growing needs of precise time synchronization.

A new UTC system was adopted by the International Radio Consultative Committee (CCIR) in Geneva in February 1971 [35, 36] and became effective 1 January 1972 (see ann. 1.B). In this new system all clocks run at the correct rate (zero offset). This leaves us in a position of having the clock rate not exactly commensurate with the length of the day.

This situation is not unique. The length of the year is not an integral multiple of the day. This is the origin of "leap year." In this case, years which are divisible by 4 have an extra day—February 29—unless they are also divisible by 100, and then only if they are *not* divisible by 400. Thus, the years 1968, 1972, 1976, and 2000 are leap years. The year 2100

will *not* be a leap year. By this means our calendar does not get out of step with the seasons.

With this as an example, it is possible to keep the clocks in approximate step with the sun by the infrequent addition (or deletion) of a second—called a “leap second.” Thus, there may be special situations where a “minute” contains 61 (or 59) seconds instead of the conventional 60 seconds. This should not occur more often than about once a year. By international agreement, UTC will be maintained within about 0.7 second of the navigators’ time scale, UT1. The introduction of leap seconds allows a good clock to keep approximate step with the sun. Because of the variations in the rate of rotation of the earth, however, the occurrences of the leap seconds are not predictable in detail.

### 1.4.8. Comparisons of Time Scales

It is of value in comparing time scales to consider four significant attributes of some time scales:

- a. accuracy and precision,
- b. reliability,
- c. universal accessibility,
- d. extension.

In the areas of accuracy and precision, atomic time scales have a clear advantage over their astronomical counterpart. Atomic clocks may be able to make a reasonable approach to the reliability and accessibility of astronomical clocks, however, astronomical time scales are based on a “single” clock which is available to everyone (i.e., only one solar system is available for study). Also, many atomic clocks can show disagreements, an impossibility with only one clock. The extension of dates to past events (indeed, remote, past events) is a feature which atomic clocks will never possess. Their utility for future needs, however, is quite another matter. The needs of the general scientific community and, in particular, the telecommunications industries are making ever greater demands on accurate and precise timing covering longer time intervals. Often these needs cannot be met by astronomical time. However, the continued motion of the solar system gives a reliability to astronomical time scales which atomic clocks have not yet attained.

One can imagine synchronizing a clock with a hypothetically ideal time scale. Some time after this synchronization our confidence in the clock reading has deteriorated. Figure 1.9 shows the results of some statistical studies which indicate the probable errors of some important clocks after synchronization. There are really two things of significance to note in figure 1.9: First, Atomic Time (state of the art, 1964) is about 10,000 times more uniform than Universal Time, and second, measurement uncertainty totally limits any knowledge of statistical fluctuations in Ephemeris Time.

### PROBABLE CLOCK ERRORS (NON-UNIFORMITY)

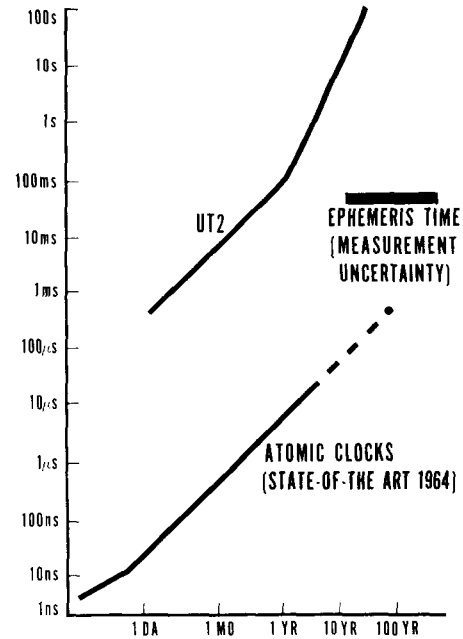

Fig. 1.9. Probable errors of 3 clock types after synchronization.

#### 1.4.8.1. Reliability and Redundancy

In the past, reliable operation of atomic frequency standards has been a significant problem. Presently, however, commercial units with a Mean Time Between Failure (MTBF) exceeding 1 year are not uncommon [37]. Finite atom source lifetime prevents unlimited operation without interruption, however.

It is true that a MTBF exceeding 1 year reflects significant engineering accomplishments, but this is far from comparable to the high reliability of astronomical time. The obvious solution is to introduce redundancy in the clock system. One can use several atomic clocks in the system and this should certainly be the best approach in the sense of accuracy and reliability—it is expensive, however.

Suppose the synthesizer-counter subsystem of a clock system should jump a small amount and cause a discontinuity in its indicated time. It is possible that such a transient malfunction could occur with no outwardly apparent signs of malfunction of the apparatus. It is also apparent that if only two clocks are available for intercomparison, it is impossible to decide which clock suffered the transient malfunction. Thus, three clocks (not necessarily all atomic) constitute an absolute minimum for reliable operation. If one or more of these has an extended probable down time (e.g., while the atom source is replenished) then 4 or 5 clocks become a more workable minimum.

It should be noted here that one could assemble a large group of clocks into one system and the system MTBF calculated from the individual MTBF's might extend into geologic time intervals. This system MTBF is undoubtedly over-optimistic due to neglect of the possibilities of catastrophes or operator errors. Nonetheless, with various atomic clocks spread over the earth, it should be possible to maintain an atomic time scale with a reliability that could satisfy almost any future demand.

## 1.5. INTERNATIONAL ATOMIC TIME (TAI) SCALE

In recent years the General Conference of Weights and Measures (CGPM) has been encouraged to adopt an International Atomic Time (TAI) scale [38] (see ann. 1.A). For such a scale to be of value the following attributes are required:

- a. It must provide greater accuracy and convenience than the astronomical counterparts.
- b. It must be highly reliable with almost no chance of a failure of the clock system. (This can be accomplished by using many clocks dispersed over the world but which can be inter-compared accurately.)
- c. The atomic time scale must be readily available everywhere.

Indeed, all of these points appear to be more than adequately covered by the atomic time scale of the BIH. In October 1971 the CGPM endorsed the BIH atomic time scale as the International Atomic Time scale [31] (see ann. 1.A) defined as follows:

"International Atomic Time is the time reference coordinate established by the Bureau International de l'Heure on the basis of the readings of atomic clocks functioning in various establishments in accordance with the definition of the second, the S.I. Unit (International System of Units) of time."

The Atomic Time (AT) scales maintained in the U.S. (by both NBS and USNO) constitute  $\sim 37\frac{1}{2}$  percent of the stable reference information used in maintaining a stable TAI scale by the BIH [39]. The question of the accuracy of rate of the TAI scale is not now completely specified [40]. There is a question of formal averaging procedures for correcting TAI. A special meeting of the Consultative Committee for the Definition of the Second (CCDS) was held in Paris, France, July 1972, to consider the status of atomic frequency standards and improved realization of the TAI, among other pertinent questions. Recommendations of this committee (6th Session of CCDS) are given in Annex I.C.

Dr. Guinot, Director of the BIH, recommended a new method of calculation of TAI. By using individual clock data in place of local time scales from various laboratories, improved weighting of clock data is anticipated [40]. Some advantages of the individual clock procedure he pointed out are as follows:

"1. Most of the local time scales are based on a small number of clocks. Irregularities of TAI are due to changes of frequencies of certain TA(i) which cannot be seen at the local level when the number of standards in effective use has to be less than 3. This happens frequently. In a global treatment, such irregularities would be visible.

2. Isolated standards could be employed. For example, at least 12 cesium standards conveniently available and compared to the Loran C pulses or TV pulses are available in Europe, not including those at the Loran C stations.

3. The treatment of all the standards would be unified, described in detail, and understood by all. At present, it is practically impossible to understand how TAI is calculated since it is necessary to understand the methods of each participating laboratory, methods which are not always published.

4. The direct calculation of TAI would allow a complete freedom to the laboratories in order to establish the TA(i), according to their criteria, without which they have to be preoccupied with the criteria adopted by TAI."

A tentative schedule for work of the BIH for improving TAI is given in Annex I.C. A complete description of the construction of a local atomic time scale is treated by D. Allan et al. in chapter 9.

The UTC scales of the USA are coordinated with UTC(BIH) to within a tolerance of about  $\pm 10 \mu\text{s}$ . All of the UTC scales are supposed to agree with UTC(BIH) to  $\pm 1$  millisecond by International Radio Consultative Committee (CCIR) agreement [36]. For those desiring accurate UT information, corrections are encoded into standard time broadcasts [36]. Yet, even with the existence of an International Atomic Time scale, one must recognize that there will be continued need for the astronomical time scales. A person doing celestial navigation, for example, must know earth position (UT1).

## 1.6. THE CONCEPTS OF FREQUENCY AND TIME INTERVAL

The four independent base units of measurement currently used in science are length, mass, time, and temperature. It is true that, except for fields of science such as cosmology, geology, and astronomy, time interval is the most important concept, and (astronomical) date is of much less importance to the rest of science. This is true because the "basic laws" of physics are differential in nature and only involve small time intervals. In essence, physical "laws" do not depend upon when (i.e., the date) they are applied.

Based on these laws and extensive experimentation, scientists have been able to demonstrate that *frequency* can be controlled and measured with the smallest percentage error of any physical quantity. The frequency of a periodic phenomenon is the number of cycles of this phenomenon per unit of time (i.e., per second). The name of the unit of frequency is the hertz (Hz) and is identical to a cycle per second (cps). Since most clocks depend upon some periodic phenomenon (e.g., a pendulum) in order to "keep time," and since one can make reliable electronic counters to count the "swings" of

the periodic phenomenon, we can construct clocks with timekeeping accuracy (rate accuracy) equal to the accuracy of the frequency standard.

In terms of the advancement of time scales, the history of the definition of the second can be expressed very briefly. Prior to 1956, the second was defined as the fraction  $1/(86,400)$  of a mean solar day; from 1956 to 1967 it was the ephemeris second defined as the fraction  $1/(31\,556\,925.9747)$  of the tropical year at 00h 00m 00s 31 December 1899, and since 1967, in terms of a resonance of the cesium atom [41] (see ann. 1.A). The present definition of the second states:

“The second is the duration of 9 192 631 770 periods of the radiation corresponding to the transition between the two hyperfine levels of the ground state of the cesium-133 atom”. (13th CGPM (1967), Resolution 1), [42].

Today’s most precise and accurate clocks incorporate a cesium atomic beam as the “pendulum” of the clock.

### 1.6.1. Time Interval and Time Scales

One should note sources of confusion which can exist in the measurement of time and in the use of the word “second.” Suppose that two events occurred at two different dates. For example the dates of these two events were 15 December 1970, 15h 30m 00.000000s UTC and 15 December 1970, 16h 30m 00.000000s UTC. At first thought one would say that the time interval between these two events was exactly 1 hour = 3600.000000 seconds, but this is *not* true. (The actual interval was longer by about 0.000108 seconds [ $3600 \text{ seconds} \times 300 \times 10^{-10}$ ]. See table 1.1.) Recall that the UTC time scale (like all the UT scales and the ET scale) was not defined in accordance with the definition of the interval of time, the second. Thus, one cannot simply subtract the dates of two events as assigned by the UTC scale (or any UT scale or the ET scale) in order to obtain the precise time interval between these events. Historically, the reason behind this state of affairs is that navigators need to know the earth’s position (i.e., UT1)—not the duration of the second. Yet, many scientists need to know an exact and reproducible time interval. Note that this might also be true of the new UTC system if the particular time interval included one or more leap seconds.

It is also confusing that the dates assigned by the UT, ET, and UTC scales involve the same word as the unit of time interval, the second. For accurate and precise measurements, this distinction can be extremely important.

## 1.7. USES OF TIME SCALES

The study of time scales can be divided into the study of time scales used for systems synchroniza-

tion and time scales used for celestial navigation and astronomy.

### 1.7.1. Time Scales for Systems Synchronization Uses

Long ago people were simply content to let the sun govern their lives. Sunrise indicated time to arise and begin work; sunset signalled the day’s end. With the advancement of civilization, growth of commerce and city life and technological gains, communities were established which instituted clocks set to agree roughly with the apparent movement of the sun. Thus developed the idea of local time and each community could have its *own* local time. Clearly, when almost all communications and business transactions occur within a given community or locale, this is a workable solution. With the advent of railroads and hence more rapid communications, this “crazy-quilt” maze of individual local times had to end. The railroads are generally credited with unifying the various local times into time zones in the continental U.S., resulting in a much more workable national time system. In 1884 an international conference recommended that the meridian of Greenwich, England be the standard reference meridian for longitude and time [43]. Longitude meridians, each  $15^\circ$ , represent 1 hour time-zone differences  $\pm 12$  hours east and west of Greenwich. Figure 1.10 shows the standard time zones of the world in effect today.

This brief historical sequence illustrates that, as communications become more rapid and more far-reaching, the greater are the demands on an all-pervasive and unifying convention of synchronizing clocks with each other. That is, this *convention* is a matter of convenience and there is nothing sacred or absolute about what our clocks read; it’s just important that they read the same time (or have a well-defined time difference as between the time zones). In the days when the railroads were the primary means of transportation across the North American continent, an accuracy of a few seconds of time was important and sufficient. Nowadays, with the existence of sophisticated telecommunications equipment capable of sending and receiving several million alphanumeric characters each *second*, there are real needs for clock synchronizations at accuracy levels of a millionth of a second and better.

### 1.7.2. Time Scales for Celestial Navigation and Astronomical Uses

As pointed out previously, time is essential for celestial navigation. If one knows what time it is (i.e., solar time) at some reference point—say the Greenwich Meridian—and also his local time as indicated by a sundial—one can figure his longitude,

# STANDARD TIME ZONES OF THE WORLD

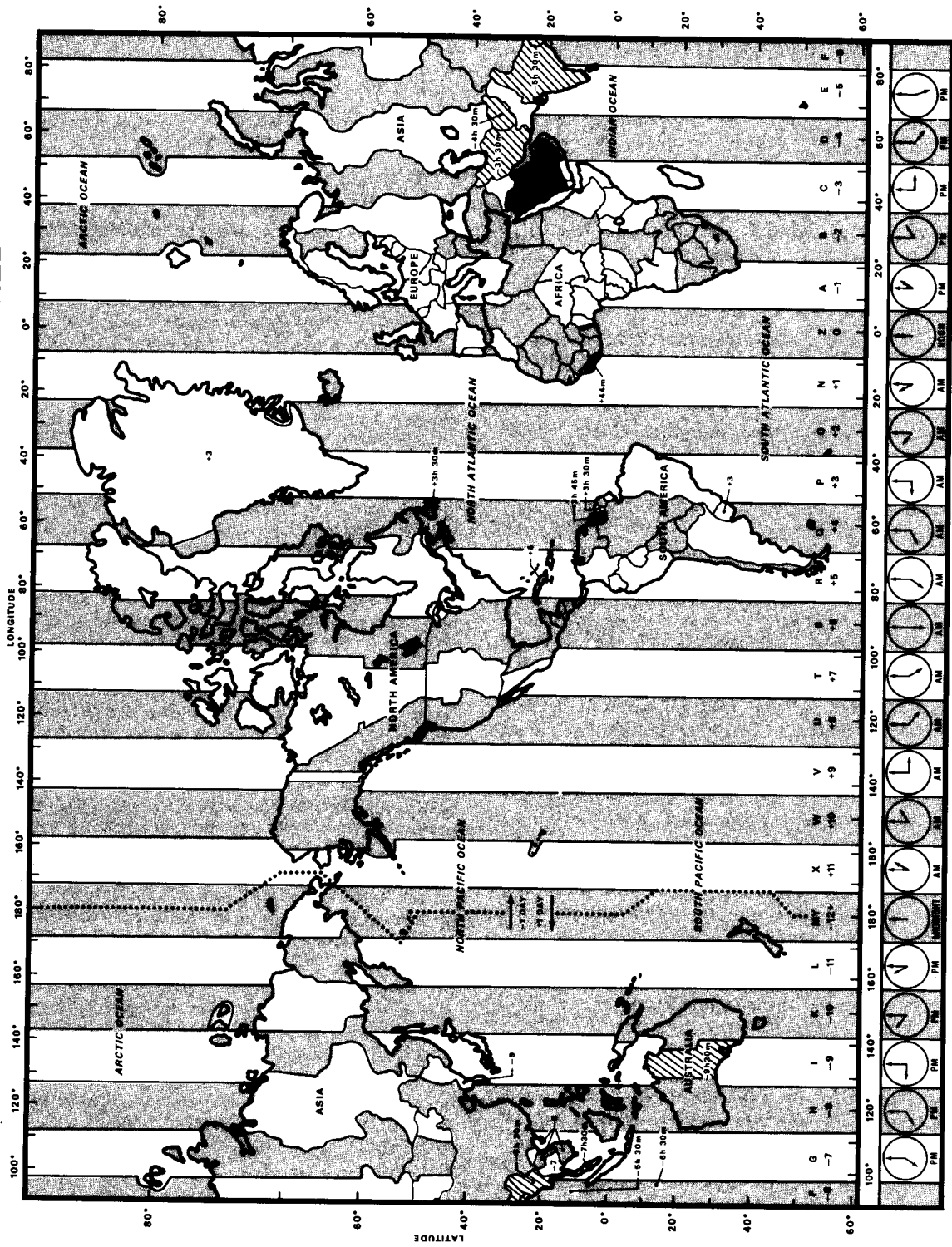

Fig. I.10. Standard time zones of the world.

since the earth makes one complete revolution (360°) on its axis in about 24 hours. For example, noon Greenwich Mean Time is 0200 Hawaiian Standard Time or 10 hours different. Thus, one can easily calculate that Hawaii is about  $\frac{10}{24}$  of the way around the world from Greenwich, England—i.e., about 150° west of the Prime Meridian. If this person were to measure the actual position of the sun in the sky using, say, a navigator's sextant, then he could get a rather accurate determination of local solar time. The key problem is knowledge of correct time on the Greenwich Meridian.

Nearly 200 years ago, a man in England named Harrison was awarded £20,000 for designing and building a chronometer which would allow the accurate determination of longitude while at sea (less than 1 minute error after 5 months at sea [44]). Until radio signals were available in the early 1900's, navigation at sea was totally dependent upon good clocks. Today, there are many standard time broadcast stations in the world which can provide time signals accurate to better than 1 second of earth time, UT1 [45].

If astronomical time could be measured with sufficient accuracy and convenience, then astronomical time could be used for system synchronization uses also. In actuality, astronomical time is difficult to measure, and accuracies of a few thousandths of a second may be realized only after the averaging of a whole evening's sightings by a sophisticated and well-equipped observatory. The accurate determination of UT1 involves measurements at, at least, two observatories widely separated in longitude.

## 1.8. CONCLUSIONS

Two very different uses for time have been discussed. The first is a convention which, when universally accepted, allows both rapid and efficient communications systems to function. The needs here are for extremely precise and uniform measurements of time. The second use is for celestial navigation and astronomical observations. Here there is not the need for highly precise time, at least not to the same degree as the first mentioned use.

Because of the conflicting requirements imposed on time scales by these two categories of time scale users, there has been a great deal of effort to obtain a compromise time scale which adequately reflects the relative importance of these two user groups. As one might well imagine, with the growing importance and sophistication of communications systems and the implementation of electronic navigation systems (to replace celestial navigation), the trend in the compromise time scales has been away from time scales based on the earth's rotation (i.e., astronomical time scales) and toward a pure atomic time scale.

In this compromise scale, UTC, one finds himself in a rather familiar situation. There is not a whole number of days in the year and one doesn't want the calendar to get badly out of step with the seasons. Similarly, there is not a whole number of seconds in a solar day and one doesn't want our clocks to get badly out of step with the sun. The solution (as noted above) is analogous to the leap year with its extra day; we have an extra second—a leap second which must be added or deleted on occasion.

## 1.9. REFERENCES

- [1] Needham, J., Ling, W., and de Solla Price, D. J., *Heavenly Clockwork*, 254 pages (The University Press, Cambridge, London, England, 1960).
- [2] Jones, H. Spencer, "The measurement of time," *Reports on Progress in Physics*, **4**, pp. 1-26 (1937) (The University Press, Cambridge, London, England, 1938).
- [3] Mueller, I. I., *Spherical and Practical Astronomy as Applied to Geodesy*, pp. 319-400 (Frederick Ungar Publishing Co., New York, N.Y. 10003, 1969).
- [4] Ward, F. A. B., *Time Measurement*, Pt. 1—Historical Review, 60 pages (H.M.S.O., William Clowes and Sons Ltd., London, England, 1961).
- [5] Marrison, W. A., "The evolution of the quartz crystal clock," *Bell Sys. Tech. J.*, **27**, No. 3, pp. 510-588 (July 1948).
- [6] Hood, P., *How Time is Measured*, 64 pages (Oxford University Press, London, England, 1955).
- [7] Cohn, N., "Power systems—time and frequency," *Leads and Northrup Tech. J.*, No. 7, pp. 3-11 (Fall 1969).
- [8] Lyons, H., "Atomic clocks," *Scientific American*, **196**, No. 2, pp. 71-82 (February 1957).
- [9] Essen, L., "Time scales," *Metrologia*, **4**, No. 4, pp. 161-165 (July 1969).
- [10] Becker, G., "Von der Astronomischen zur Atomphysikalischen Definition der Sekunde," (From the astronomical to the atomic definition of the second.) *PTB-Mitteilungen*, **76**, No. 4, pp. 315-323 and No. 5, pp. 415-419 (August/October 1966) (in German).
- [11] Kovalevsky, J., "Astronomical time," *Metrologia*, **1**, No. 4, pp. 169-180 (October 1965).
- [12] Fraser, J. T., *Voices of Time*, pp. 281, 296, 312, 401 (George Braziller, Inc., One Park Avenue, New York, N.Y. 10016, 1966).
- [13] Cousins, F. W., *Sundials—A Simplified Approach by Means of the Equatorial Dial*, 249 pages (Universe Book, Inc., New York, N.Y. 10016, 1970).
- [14] Mueller, I. I., see Ref. [3], pp. 141-145.
- [15] Mueller, I. I., see Ref. [3], pp. 476-518.
- [16] Guinot, B., Feissel, M., and Granveaud, M., *Bureau International de l'Heure Annual Report for 1970*, pp. 37-62 (BIH, Paris, France, 1971).
- [17] Scheibe, A., and Adelsberger, U., "Die Technischen Einrichtungen der Quarzuhren der Physikalisch-Technischen Reichsanstalt," (Technical development of quartz clocks of the PTR) *Hochfrequenz-technik und Elektroakustik*, **43**, pp. 37-47 (February 1934) (in German).
- [18] Essen, L., Parry, J. V. L., Markowitz, W., and Hall, R. G., "Variation in the speed of rotation of the earth since 1955," *Nature (Lett.)*, **181**, No. 4615, p. 1054 (April 12, 1958).
- [19] Essen, L., Parry, J. V. L., and Steele, J. McA., "Frequency variations of quartz oscillators and the earth's rotation in terms of the N. P. L. cesium standard," *Proc. Inst. Elec. Eng. (England)*, **107**, Part B, No. 33, pp. 229-234 (May 1960).
- [20] Brouwer, D., "A study of the changes in the rate of rotation of the earth," *Astron. J.*, **57**, No. 5, pp. 125-146 (September 1952).

- [21] Munk, W. H., and MacDonald, G. D. F., *The Rotation of the Earth*, Chap. 8 (Cambridge University Press, London, England, 1960).
- [22] Sidorenkov, N. S., "Neravnomerivost' vrashcheniya zemli podannym astronomicheskikh noblyudeniy za period 1955.5-1965.0 gg." (Non-uniformity in the rotation of the earth according to the data of astronomic observations for the period 1955.5-1965.0), *Astronomicheskij J.* (USSR), **44**, No. 3, pp. 650-662 (1967-English translation, NTIS, AD 667076, January 1968).
- [23] Blackman, R. B., and Tukey, J. W., *The Measurement of Power Spectra*, pp. 151-159 (Dover Publications, Inc., New York, N.Y. 10014, 1958).
- [24] Iijima, S., Matsunami, N., and Okazaki, S., "On the abrupt change in the earth's rotation at the beginning of 1963," *Ann. Tokyo Astron. Observatory*, 2nd series, **VIII**, pp. 207-217 (August 1964).
- [25] Nicholson, W., and Sadler, D., "Atomic standards of frequency and the second of ephemeris time," *Nature (Lett.)*, **210**, No. 5032, p. 187 (April 9, 1966).
- [26] Barnes, J. A., and Allan, D. W., "An approach to the prediction of coordinated universal time," *Frequency*, **5**, No. 6, pp. 15-20 (November-December 1967).
- [27] NBS, "The atomic clock—an atomic standard of frequency and time," *Nat. Bur. Stand. (U.S.) Tech. News Bull.*, **33**, No. 2, pp. 17-24 (USGPO, February 1949).
- [28] BIH, *Bulletin Horaire*, Ser. J., No. 7, p. 2 (BIH, Paris, France, January/February 1965).
- [29] Markowitz, W., "The atomic time scale," *IRE Trans. on Instrum.*, **I-11**, Nos. 3 and 4, pp. 239-242 (December 1962).
- [30] Bonanomi, J., Kartaschoff, P., Newman, J., Barnes, J. A., and Aktinson, W. R., "A comparison of the TA<sub>1</sub> and the NBS-A atomic time scales," *Proc. IEEE (Corres.)*, **52**, No. 4, p. 439 (April 1964).
- [31] CGPM, *Comptes Rendus des Séances de la Quatorzième Conférence Générale des Poids et Mesures* (Proceedings of the Sessions of the 14th General Conference of Weights and Measures) (Paris, France, October 4-8, 1971), pp. 49-52; 77-78 (BIPM, Sèvres, France, 1972) (in French—see ann. I.A.3).
- [32] Essen, L., "The international co-ordination of time scales and standard frequency transmissions," *Nature (Lett.)*, **187**, No. 4736, pp. 452-453 (August 6, 1960).
- [33] CCIR, "Standard frequency and time signal emissions," Recommendation 374-1, *Documents of the XIth Plenary Assembly* (Oslo, Norway, 1966), III, pp. 281-282 (ITU, Geneva, Switzerland, 1967).
- [34] Hudson, G. E., "Some characteristics of commonly used time scales," *Proc. IEEE*, **55**, No. 6, pp. 815-821 (June 1967).
- [35] CCIR, "Standard-frequency and time-signal emissions," (Recommendation 460), in *XIIth Plenary Assembly CCIR*, (New Delhi, India, 1970), III, p. 227 (ITU, Geneva, Switzerland, 1970) (see ann. I.B.1).
- [36] CCIR, "Detailed instructions by Study Group 7 for the implementation of Recommendation 460 concerning the improved coordinated universal time (UTC) system, valid from 1 January 1972," in *XIIth Plenary Assembly CCIR*, (New Delhi, India, 1970) III, p. 258 a-d (ITU, Geneva, Switzerland, 1970) (see ann. I.B.2).
- [37] Hyatt, R., Throne, D., Cutler, L., Holloway, J. H., and Mueller, L. F., "Performance of newly developed cesium beam tubes and standards," *Proc. 25th Ann. Symp. on Frequency Control* (U.S. Army Electronics Command, Ft. Monmouth, NJ 07703, April 26-28, 1971), p. 316 (NTIS, AD 746211, 1971).
- [38] CCDS, "Recommandations du comité consultatif pour la définition de la seconde . . ." (Recommendations of the Consultative Committee for the definition of the second . . .) *Comité Consultatif pour la Définition de la seconde*, (CIPM, 5<sup>e</sup> Session, Paris, France, June 18-19, 1970), pp. S21-S23 (BIPM, Sèvres, France, 1971) (in French—see ann. I.A.2).
- [39] Guinot, B., Feissel, M., and Granveaud, M., see Ref. [16], p. 28.
- [40] Guinot, B., (Reporter), "Sixième rapport du comité consultatif pour la définition de la seconde au comité international des poids et mesures," (Minutes of 6th session consultative committee for the definition of the second) (CIPM, 6<sup>e</sup> Session, Paris, France, July 6-7, 1972) (BIPM, Sèvres, France, 1972) (in French—see ann. I.C).
- [41] Smith, H. M., "International time and frequency coordination," *Proc. IEEE*, **60**, No. 5, pp. 479-487 (May 1972).
- [42] CGPM, *Comptes Rendus des Séances de la Treizième Conférence Générale des Poids et Mesures* (Proceedings of the Sessions of the 13th General Conference of Weights and Measures) (Paris, France, October 1968), p. 103 (Gauthier-Villars, Paris, France 1968) (in French—see ann. I.A.1).
- [43] IMC, *International Meridian Conference, Washington, for the Purpose of Fixing a Prime Meridian and a Universal Day* (Gibson Bros., Washington, DC, 1884).
- [44] Ward, F. A. B., see Ref. [4], pp. 29-31.
- [45] CCIR, "Standard frequency and time signals," (Study Group 7) *XIIth Plenary Assembly* (New Delhi, India, 1970), III, pp. 229-240 (ITU, Geneva, Switzerland 1970).

## I.10. BIBLIOGRAPHY

- [B1] Barnes, J. A., "The development of an international atomic time scale," *Proc. IEEE*, **55**, No. 6, pp. 822-826 (June 1967).
- [B2] Brouwer, D., "The accurate measurement of time," *Physics Today*, **4**, No. 8, pp. 6-15 (August 1951).
- [B3] Davey, W. R., "A review of studies made on the decade fluctuations in the earth's rate of rotation," *Nat. Bur. Stand. (U.S.), Tech. Note* **358**, 16 pages (USGPO, October 1967)[Note: Contains many pertinent references on earth rotation variations.]
- [B4] Decaux, B., and Guinot, B., *La Mesure du Temps* (The measure of time), 126 pages (Presses Universitaires de France, 108, Boulevard Saint-Germain, Paris 1969) (in French).
- [B5] Guinot, B., "Characteristics of a scale of time," *Alta Frequenza*, **40**, No. 8, pp. 320E-322E (August 1971) (in English).
- [B6] HMSO/USNO, *Explanatory Supplement to the Astronomical and the American Ephemeris and Nautical Almanac*, prepared jointly by the Nautical Almanac Office of the United Kingdom and the United States of America—USNO (Her Majesty's Stationary Office, London, England, 1961).
- [B7] Jones, H. Spencer, "Variations of the earth's rotation," *Physics and Chemistry of the Earth*, **4**, Chap. 4, pp. 186-210 (Pergamon Press, London, England, 1961).
- [B8] Lewis, F. D., "Frequency and time standards," *Proc. IRE*, **49**, No. 9, pp. 1046-1068 (September 1955).
- [B9] Markowitz, W., Hall, Glenn R., Essen, L., and Parry, J. V. L., "Frequency of cesium in terms of ephemeris time," *Phys. Rev. Lett.*, **1**, pp. 105-108 (August 1958).
- [B10] Markowitz, W., "Variations in the rotation of the earth, results obtained with the dual rate moon camera and photographic zenith tubes," *Astron. J.*, **64**, No. 1268, pp. 106-113 (April 1959).
- [B11] Milham, W. I., *Time and Timekeepers*, 616 pages, (Macmillan Co., New York, N.Y. 10022, 1941).
- [B12] Mungall, A. G., "Atomic time scales," *Metrologia*, **7**, No. 4, pp. 146-153 (October 1971).
- [B13] Richardson, J. M., and Brockman, J. F., "Atomic standards of frequency and time," *The Physics Teacher*, **4**, No. 6, pp. 247-256 (September 1966).
- [B14] Smith, H. M., "The determination of time and frequency," *Proc. Inst. Elec. Eng. (England)*, **98**, Pt. II, pp. 143-153 (April 1951).
- [B15] Woolard, E. W., and Clemence, G. M., *Spherical Astronomy*, 453 pages (Academic Press, New York, N.Y. 10003, 1966).

**ANNEX 1.A**  
**DEFINITION OF THE SECOND AND TAI<sup>†</sup>**

**Contents**

	Page
1.A.1. Definition of the Second.....	17
1.A.2. Recommendations of the 5th Session of the Consultative Committee for the Definition of the Second.....	19
1.A.3. Some Results of the 14th General Conference of Weights and Measures (CGPM) in October 1971.....	25
1.A.3.a. Unit of Time and Time Scale; Arrangements with the BIH presented by CCDS...	26
1.A.3.b. Resolutions Adopted by the 14th General Conference of Weights and Measures (CGPM) in October 1971 .....	26

---

<sup>†</sup> Original language versions in French are followed with English translations.



## 1.A.1. Definition of the Second\*

### RÉSOLUTIONS ADOPTÉES PAR LA 13<sup>e</sup> CONFÉRENCE GÉNÉRALE

---

#### Systeme International d'Unités (SI)

Unité de temps (seconde)

#### RÉSOLUTION

*La Treizième Conférence Générale des Poids et Mesures,*

#### CONSIDÉRANT

*que la définition de la seconde décidée par le Comité International des Poids et Mesures à sa session de 1956 (Résolution 1) et ratifiée par la Résolution 9 de la Onzième Conférence Générale (1960), puis maintenue par la Résolution 5 de la Douzième Conférence Générale (1964) ne suffit pas aux besoins actuels de la métrologie,*

*qu'à sa session de 1964 le Comité International des Poids et Mesures, habilité par la Résolution 5 de la Douzième Conférence Générale (1964), a désigné pour répondre à ces besoins un étalon atomique de fréquence à césium à employer temporairement,*

*que cet étalon de fréquence est maintenant suffisamment éprouvé et suffisamment précis pour servir à une définition de la seconde répondant aux besoins actuels,*

*que le moment est venu de remplacer la définition actuellement en vigueur de l'unité de temps du Système International d'Unités par une définition atomique fondée sur cet étalon,*

#### DÉCIDE

*1° L'unité de temps du Système International d'Unités est la seconde définie dans les termes suivants :*

*« La seconde est la durée de 9 192 631 770 périodes de la radiation correspondant à la transition entre les deux niveaux hyperfins de l'état fondamental de l'atome de césium 133 ».*

*2° La Résolution 1 adoptée par le Comité International des Poids et Mesures à sa session de 1956 et la Résolution 9 de la Onzième Conférence Générale des Poids et Mesures sont abrogées.*

---

\*CGPM. *Comptes Rendus des Séances de la Treizième Conférence Générale des Poids et Mesures* (Proceedings of the Sessions of the 13th General Conference of Weights and Measures) (Paris, France, October 1968), p. 103 (Gauthier-Villars, Paris, France 1968) (in French).

**1.A.1. Definition of the Second\*†**  
**Resolutions Adopted by the 13th General Conference**

---

**International System of Units (SI)**

Unit of Time (Second)

**RESOLUTION**

The 13th General Conference of Weights and Measures,

**CONSIDERING**

that the definition of the second decided by the International Committee of Weights and Measures at its session of 1956 (resolution 1) and ratified by Resolution 9 of the 11th General Conference 1960, then maintained by the 5th Resolution of the 12th

---

\*CGPM. *Comptes Rendus des Séances de la Treizième Conférence Générale des Poids et Mesures* (Proceedings of the Sessions of the 13th General Conference of Weights and Measures) (Paris, France, October 1968), p. 103 (Gauthier-Villars, Paris, France 1968) (In French).

†English translation.

General Conference 1964, does not satisfy the actual needs of metrology.

that at its session of 1964 the International Committee of Weights and Measures, enabled by the 5th Resolution of the 12th General Conference 1964, in order to respond to these needs designated a cesium atomic frequency standard to be employed temporarily.

that this frequency standard is now sufficiently proven and sufficiently precise to serve as a definition of the second responding to actual needs.

that the moment has now come to replace the actual definition in force for the unit of time of the International System of Units by an atomic definition based on this standard.

**DECIDES**

1. The unit of time of the International System of Units is the second defined in the following terms: "The second is the duration of 9 192 631 770 periods of the radiation corresponding to the transition between the two hyperfine levels of the ground state of the cesium 133 atom."

2. Resolution 1 adopted by the International Committee of Weights and Measures at its session of 1956 and Resolution 9 of the 11th General Conference of Weights and Measures are annulled.

## 1.A.2. Recommendations of the 5th Session of the Consultative Committee for the Definition of the Second\*

### Recommandations <sup>(2)</sup> du Comité Consultatif pour la Définition de la Seconde présentées au Comité International des Poids et Mesures

Proposition d'adoption d'une échelle de Temps Atomique International

RECOMMANDATION S 1 (1970)

*Le Comité Consultatif pour la Définition de la Seconde,*

CONSIDÉRANT

1° *Le désir général de synchroniser ou de coordonner l'ensemble des émissions de signaux horaires diffusés dans le monde ;*

2° *le besoin d'une référence de temps uniforme pour l'étude de la dynamique des systèmes et, en particulier, pour l'étude des mouvements des corps célestes naturels et artificiels ;*

---

(<sup>1</sup>) *Note du B.I.P.M.* — Les représentants des laboratoires japonais ont fait savoir, par lettre du 12 août 1970, leur accord général avec les vues exprimées par le C.C.D.S. En particulier, ils soulignent l'importance de la Recommandation S 3 et des règles pour la mise en pratique du Temps Atomique International, et ils approuvent les propositions d'aide financière au B.I.H.

(<sup>2</sup>) Les numéros initialement attribués à ces recommandations ont été changés après l'examen par les membres du C.C.D.S. du projet du rapport de la session :

— La Recommandation S 1 correspond à l'ancienne Recommandation S 1 amputée du considérant 4°; ce paragraphe est reporté en remarque finale de l'ensemble des Recommandations adoptées.

— La Recommandation S 2 est inchangée.

— La Recommandation S 3 correspond à l'ancienne Recommandation S 4.

— La Recommandation S 4 correspond à l'ancienne Recommandation S 5.

— Les règles pour la mise en pratique du Temps Atomique International correspondent à l'ancienne Recommandation S 3.

Ces Recommandations ont été approuvées par le Comité International des Poids et Mesures à sa 59<sup>e</sup> session (octobre 1970).

---

\*CCDS, "Recommandations du comité consultatif pour la définition de la seconde . . ." (Recommendations of the Consultative Committee for the definition of the second . . .) *Comité Consultatif pour la Définition de la Seconde* (CIPM, 5<sup>e</sup> Session, Paris, France, 18-19 June 1970), pp. S21-S23 (Bur. Internat. des Poids et Mesures, Sèvres, France, 1971) (in French).

3° l'utilité d'une échelle de temps aussi uniforme que possible pour servir de base à la comparaison des étalons de fréquence opérant en des lieux et à des instants différents ;

RECOMMANDE l'adoption d'une échelle de Temps Atomique International.

Proposition de définition du Temps Atomique International

RECOMMANDATION S 2 (1970)

*Le Comité Consultatif pour la Définition de la Seconde propose de définir le Temps Atomique International (TAI) comme suit :*

« *Le Temps Atomique International est la coordonnée de repérage temporel établie par le Bureau International de l'Heure sur la base des indications d'horloges atomiques fonctionnant dans divers établissements conformément à la définition de la seconde, unité de temps du Système International d'Unités* ».

Poursuite des recherches sur les étalons atomiques de fréquence et sur les méthodes d'évaluation du Temps Atomique International

RECOMMANDATION S 3 (1970)

*Le Comité Consultatif pour la Définition de la Seconde,*

*CONSIDÉRANT que le nombre des étalons primaires de fréquence et leur exactitude sont à peine suffisants pour contrôler le maintien d'une durée constante de l'intervalle unitaire de l'échelle de Temps Atomique International,*

*RECOMMANDE aux organismes compétents d'entreprendre ou de poursuivre activement les recherches en vue d'une réalisation plus exacte de la seconde du Système International d'Unités.*

RECOMMANDATION S 4 (1970)

*Le Comité Consultatif pour la Définition de la Seconde,*

*CONSIDÉRANT que l'expérience acquise n'est pas suffisante pour que l'on puisse dès maintenant fixer les règles de pondération des indications des horloges atomiques contribuant à l'établissement de l'échelle de Temps Atomique International,*

*RECOMMANDE que cette question soit étudiée activement.*

## MISE EN PRATIQUE DU TEMPS ATOMIQUE INTERNATIONAL

*Le Comité Consultatif pour la Définition de la Seconde propose les règles suivantes pour la mise en pratique de l'échelle de Temps Atomique International pendant les quelques années à venir :*

1° *La durée de l'intervalle unitaire de l'échelle de Temps Atomique International est déterminée par le Bureau International de l'Heure (B.I.H.) de façon qu'elle soit en accord étroit avec la durée de la seconde du Système International d'Unités rapportée à un point fixe de la Terre au niveau de la mer.*

2° *La durée de l'intervalle unitaire de l'échelle de Temps Atomique International est maintenue aussi constante que possible. Elle est fréquemment comparée à la durée de la seconde du Système International d'Unités telle qu'elle est obtenue à l'aide des étalons primaires de fréquence de divers établissements. Les résultats de ces comparaisons sont portés à la connaissance du B.I.H.*

3° *La durée de l'intervalle unitaire de l'échelle de Temps Atomique International n'est changée intentionnellement que si elle diffère d'une façon significative de la durée de la seconde spécifiée en 1°. Ces ajustements n'auront lieu qu'à des dates convenues à l'avance et annoncées par le B.I.H.*

4° *L'origine de l'échelle de Temps Atomique International est définie conformément aux recommandations de l'Union Astronomique Internationale (XIII<sup>e</sup> Assemblée Générale, Prague, 1967), c'est-à-dire que cette échelle s'accorde approximativement avec le TU2 à 0 heure le 1<sup>er</sup> janvier 1958.*

5° *Le procédé par lequel le Temps Atomique International est actuellement porté à la connaissance des usagers, c'est-à-dire par la publication mensuelle des écarts des échelles locales, est considéré comme satisfaisant.*

Le Comité Consultatif pour la Définition de la Seconde note que les Recommandations et propositions ci-dessus vont dans le sens des demandes approuvées par le Comité Consultatif International des Radiocommunications (C.C.I.R.) à sa 12<sup>e</sup> Assemblée Plénière (New Delhi, 1970) et par l'Union Radioscientifique Internationale (U.R.S.I.) à sa 16<sup>e</sup> Assemblée Générale (Ottawa, 1969, Résolution 1.4).

**1.A.2. Recommendations of the 5th Session  
of the Consultative Committee for the  
Definition of the Second**

presented to

**the International Committee of Weights and  
Measures\*†**

Proposition for Adoption of International Atomic  
Time Scale

**RECOMMENDATION S 1 (1970)**

The Consultative Committee for the Definition  
of the Second,

**CONSIDERING**

1. The general desire to synchronize or to coordinate the ensemble of time signal broadcasts disseminated within the world;

2. The need of a uniform time reference for the study of the dynamics of systems and, in particular, for the study of the movements of natural and artificial celestial bodies;

3. The utility of a time scale as uniform as possible to serve as the basis of comparison of frequency standards operating in different places and at different times;

**RECOMMENDS** the adoption of an International Atomic Time Scale.

Proposition for the Definition of International Atomic Time

**RECOMMENDATION S 2 (1970)**

The Consultative Committee for the Definition of the Second proposes to define International Atomic Time (TAI) as follows:

"International Atomic Time is the time reference coordinate established by the International Time Bureau on the basis of atomic clock readings functioning in various establishments conforming to the definition of the second, unit of time of the International System of Units."

Pursuit of research on atomic frequency standards and on the method of evaluation of International Atomic Time.

**RECOMMENDATION S 3 (1970)**

The Consultative Committee for the Definition of the Second,

**CONSIDERING**

That the number of primary frequency standards and their accuracy are scarcely sufficient to control the continuation of a constant duration of the unit interval of the International Atomic Time Scale,

\*CCDS, "Recommandations du comité consultatif pour la définition de la seconde . . ." (Recommendations of the Consultative Committee for the definition of the second . . .) *Comité Consultatif pour la Définition de la Seconde*, (CIPM, 5<sup>e</sup> Session, Paris, France, 18-19 June 1970), pp. S21-S23 (Bur. Internat. des Poids et Mesures, Sèvres, France, 1971) (In French).

† English translation.

**RECOMMENDS**

To competent organizations to undertake or to pursue actively research in view of a more accurate realization of the second of the International System of Units.

**RECOMMENDATION S 4 (1970)**

The Consultative Committee for the Definition of the Second,

**CONSIDERING**

That the experience acquired is not sufficient to permanently fix the rules for weighting of clock readings contributing to the establishment of the International Atomic Time Scale,

**RECOMMENDS**

That this question be studied actively.

**Mise en Pratique (Putting into Practice) of  
International Atomic Time**

The Consultative Committee for the Definition of the Second proposes the following rules for the Mise en Pratique of the International Atomic Time Scale during the next few years:

1. The duration of the unit interval of the International Atomic Time Scale is determined by the Bureau International de l'Heure (BIH) such that it be in close agreement with the duration of the second of the International System of Units relative to a fixed point on the earth at sea level.

2. The duration of the unit interval of the International Atomic Time Scale is maintained as constant as possible. It is frequently compared to the duration of the second of the International System of Units as it is obtained from the primary frequency standards of various establishments. The results of these comparisons are published by the BIH.

3. The duration of the unit interval of the International Atomic Time Scale is intentionally changed only if it differs in a significant fashion from the duration of the second specified in 1. These adjustments will take place only at dates agreed upon in advance and announced by the BIH.

4. The origin of International Atomic Time is defined in conformance with the recommendations of the International Astronomical Union (13th General Assembly, Prague, 1967) that is, this scale was in approximate agreement with 0 hours UT2 January 1, 1958.

5. The process by which International Atomic Time is brought to the awareness of users, that is by the monthly publication of differences of time scales, is considered as satisfactory.

The Consultative Committee for the Definition of the Second notes that the recommendations and the propositions above are in essential agreement to the requests approved by the CCIR at its 12th Plenary Session, New Delhi, 1970, and by URSI at its 16th General Assembly, Ottawa, 1969, Resolution 1.4.

### **1.A.3. Some Results of the 14th General Conference of Weights and Measures (CGPM) in October 1971 \***

#### **1.A.3.a Unit of Time and Time Scale; Arrangements with the BIH presented by CCDS**

##### **9. Unité de temps et échelles de temps; arrangements avec le Bureau International de l'Heure**

Mr DUNWORTH, président du *Comité Consultatif pour la Définition de la Seconde* (C. C. D. S.), présente le rapport suivant :

La mesure du temps et de l'intervalle de temps est liée dans l'esprit de la plupart des gens aux mouvements apparents du Soleil et des étoiles. Au cours des siècles, le perfectionnement par les astronomes et les navigateurs des mesures qui s'y rapportent a fourni un système qui satisfait la plupart des besoins, même ceux d'une société ayant un degré élevé de technicité. La découverte de la radio vers le début de ce siècle et de la « valve thermo-ionique » au cours de la Première Guerre mondiale conduisirent il y a une cinquantaine d'années à la création d'une nouvelle technique, celle de l'électronique. Cette technique a permis d'obtenir avec une relative simplicité et stabilité une oscillation électrique qui pouvait constituer la base d'une mesure précise de l'intervalle de temps. A l'origine, les dispositifs utilisaient les propriétés du quartz, un matériau que vous connaissez tous. Dès avant la Seconde Guerre mondiale on a couramment utilisé des oscillateurs à lampes contrôlés par quartz pour maintenir avec précision les fréquences des émetteurs de radio aux valeurs qui leur étaient attribuées par accord international. Plus récemment, on a toutefois eu la possibilité d'utiliser les propriétés des atomes individuels de substances appropriées au lieu du quartz. Cela eut comme résultat de pouvoir obtenir une base pour la fréquence, et par conséquent pour l'intervalle de temps, encore plus stable, plus précise et plus facilement reproductible. On a appelé l'horloge ainsi obtenue une « horloge atomique ». La comparaison des résultats de fonctionnement d'horloges de ce type avec le mouvement apparent des étoiles et du Soleil a révélé des irrégularités. Les savants pensent que ces irrégularités sont dues à de petites variations, erratiques, dans la vitesse de rotation de la Terre, plutôt qu'à des irrégularités systématiques dans toutes leurs horloges atomiques.

---

\*CGPM, *Comptes Rendus des Séances de la Quatorzième Conférence Générale des Poids et Mesures* (Proceedings of the Sessions of the 14th General Conference of Weights and Measures) (Paris, France, October 4-8, 1971), pp. 49-52 (BIPM, Sèvres, France, 1972) (in French).

La définition de la fréquence et de son inverse — l'intervalle de temps — est depuis longtemps l'une des préoccupations du Comité International des Poids et Mesures. Une définition d'une unité d'intervalle de temps atomique a été adoptée par la 13<sup>e</sup> Conférence Générale (1967). Toutefois il faut faire une différence entre « temps » et « intervalle de temps ». Une façon simple de faire cette différence est de considérer d'une part un chronomètre pour mesurer le temps mis par un athlète pour courir cent mètres, et d'autre part une horloge qui nous dit quand partir travailler. Pour bien des utilisations, le temps astronomique est très commode ou nécessaire, comme par exemple en navigation ou dans notre vie quotidienne. Toutefois, pour certaines utilisations scientifiques ou techniques pour lesquelles l'heure du jour en termes astronomiques est sans importance, il y a un avantage à avoir une horloge qui conserve un degré élevé d'uniformité de l'intervalle de temps sur une longue période. De plus, l'utilisation simultanée d'horloges de ce type en différents lieux peut être essentielle. Depuis de nombreuses années, des échelles de temps atomique de cette nature sont disponibles dans les pays les plus industrialisés. Le Bureau International de l'Heure, dont le siège est à Paris et qui s'occupe depuis longtemps du temps astronomique, joue depuis quelques années le rôle de centre international pour la diffusion, à titre d'essai, du temps atomique. Cette tâche supplémentaire a été rendue possible par l'aide généreuse fournie par le personnel de l'Observatoire de Paris, par le prêt d'appareils fournis par des organismes américains et par la coopération des différents pays déjà intéressés par le temps atomique. Récemment, l'Union Astronomique Internationale, l'Union Radioscopique Internationale et le Comité Consultatif International des Radiocommunications ont demandé au Comité International des Poids et Mesures de recommander à la présente Conférence Générale l'établissement d'une Échelle de Temps Atomique. Le Comité International a reconnu quatre points importants en répondant à cette demande :

- 1° Il y aura, dans un futur prévisible, de nouveaux progrès dans la façon précise de traiter le problème de l'échelle de temps atomique.
- 2° Ces progrès interviendront d'autant plus sûrement que l'on établira de façon officielle dès maintenant une échelle de temps atomique.
- 3° On aura encore besoin d'une échelle de temps liée à la rotation de la Terre et il sera indispensable de maintenir une liaison étroite avec le Bureau International de l'Heure qui continuera à fournir une telle échelle.
- 4° Il serait très coûteux pour le Bureau International des Poids et Mesures d'établir une échelle de temps atomique avec ses propres instruments et son propre personnel.

En conséquence, le Comité International des Poids et Mesures a étudié la possibilité de convaincre le Bureau International de l'Heure de mettre officiellement ses réalisations actuelles en association avec le Comité International. J'ai le grand plaisir de vous informer que le Bureau International de l'Heure répondra selon toute vraisemblance de façon favorable à une telle invitation qui ne représente qu'une modeste charge annuelle sur les fonds du Comité International. D'autre part, des discussions approfondies ont eu lieu entre des représentants du Comité International et les différents organismes internationaux qui s'occupent du temps et dont j'ai parlé plus haut. Toutes ces discussions ont conduit aux propositions présentées au point 9 de la Convocation à cette Conférence (voir p. 16). Les détails techniques précis qui sont à la base de ces propositions sont complexes; beaucoup d'entre vous les connaissent déjà et je n'essaierai pas d'en parler ici. Si la Conférence Générale approuve ces propositions, il est prévu que les nouvelles dispositions entreront en vigueur le 1<sup>er</sup> janvier 1972, à la condition qu'un accord satisfaisant soit conclu avec le Bureau International de l'Heure.

Au nom du président et des membres du Comité International des Poids et Mesures, je vous recommande vivement ces propositions et vous invite à approuver les projets de résolutions qui vous sont soumis.



### 1.A.3. Some Results of the 14th General Conference of Weights and Measures (CGPM) in October 1971\* †

#### 1.A.3.a. Unit of Time and Time Scale; Arrangements with the BIH presented by CCDS

##### 9. Unit of time and time scales; arrangements with the International Time Bureau

Mr. Dunworth, President of the Committee Consultative for the Definition of the Second (CCDS), presented the following report:

The measurement of time and of time interval is based in principle for most people on the apparent movements of the sun and stars. Through the course of centuries, the perfection of time measures by astronomers and navigators has furnished a system which satisfied most of the needs, even those of the society having a high level of technology. The discovery of radio toward the beginning of the century and of the thermionic tube during the course of the 1st World War 50 years ago led to the creation of a new technique—that of electronics. This technique has permitted the design of a relatively simple and stable electronic oscillator which can constitute the basis of a precise measure of time interval. Initially, the devices used the properties of quartz, a material which you all know well. From the beginning of the 2d World War one commonly used vacuum tube oscillators controlled by quartz to maintain the frequencies of radio transmitters precisely to the values which they were assigned by international agreement. More recently, one even has had the possibility of using the properties of individual atoms of appropriate substances in place of quartz. This has resulted in the capability of a new basis for frequency and, by consequence, for time interval even more stable, more precise, and more easily reproducible. We have called such a clock an atomic clock. Comparison results of such clocks with the apparent movement of the stars and of the sun has revealed irregularities. Experts think that these irregularities are due to small erratic variations in the velocity of the rotation of the earth, rather than those of systematic irregularities in all of their atomic clocks.

The definition of frequency and its inverse, time interval, has for a long time been one of the pre-occupations of the International Committee of Weights and Measures. A definition of a unit of atomic time interval has been adopted by the 13th General Conference (1967). However, it is necessary to note a difference between time and time interval. A simple way to make this judgment is to consider, on one hand, a chronometer which measures the time taken by an athlete to run 100 meters and, on the other hand, a clock which

tells us when to leave for work. For most uses, astronomical time is very convenient or necessary as for example in navigation or in our daily life. Yet, in certain scientific or technical uses the hour of the day in terms of astronomy is unimportant, there still is an advantage to having a clock which maintains a high degree of uniformity of time interval over a long period. Further, the simultaneous use of clocks of this type in different places can be essential. For many years atomic time scales of this nature have been available in the more industrial countries. The International Time Bureau, located in Paris and concerned for a long time with astronomical time, has played the central international role for the distribution of atomic time for many years by virtue of its tested capability. This supplementary duty has been made possible by the generous aid furnished by the personnel of the Paris Observatory, by the availability of apparatus furnished by American organizations, and by the cooperation of different countries already interested in atomic time. Recently, the International Astronomical Union, the International Scientific Radio Union, and the International Radio Consultative Committee have asked the International Committee of Weights and Measures to recommend to the present General Conference the establishment of an atomic time scale. The International Committee has recommended four important points in responding to this request:

1. In a foreseeable future there will be new progress in the precise method of treating the problem of the atomic time scale.
2. These advances will take place even more surely if one will establish an atomic time scale of an official nature now.
3. One will still have need of a time scale based on the rotation of the earth; it will be absolutely essential to maintain a close relation with the International Time Bureau which will continue to furnish such a scale.
4. It would be very costly for the International Bureau of Weights and Measures to establish an atomic time scale with its own instruments and personnel.

As a consequence, the International Committee of Weights and Measures has studied the possibility of convincing the International Time Bureau by virtue of its capability to officially seek association with the International Committee. I have the great pleasure to inform you that, most assuredly, the International Time Bureau will respond, in a favorable fashion to such an invitation; such action represents only a modest annual charge on the funds of the International Committee. On the other hand, some thorough discussions have taken place between the representatives of the International Committee and the international organizations

\*CGPM, *Comptes Rendus des Séances de la Quatorzième Conférence Générale des Poids et Mesures* (Proceedings of the Sessions of the 14th General Conference of Weights and Measures) (Paris, France, October 4-8, 1971), pp. 49-52 (BIPM, Sèvres, France, 1972) (in French).

† English translation.

which are concerned with time and of which I have spoken above. All these discussions have led to the propositions presented in point 9 of the Convocation of this Conference (see p. 16). The precise technical details which are fundamental to these propositions are complex. Many among you already know this, and I will not try to speak of it here. If the General Conference approves these propositions it is seen that the new arrangements will enter in force 1 January 1972 under the condition that a satisfying accord be concluded with the International Bureau of Time.

Under the name of the president and the members of the International Committee of Weights and Measures I strongly recommend these propositions to you and invite your approval of the resolutions which are submitted to you.

### **1.A.3.b. Resolutions Adopted by the 14th General Conference of Weights and Measures (CGPM) in October 1971\***

#### **Resolutions Adopted by the 14th General Conference\***

##### **International Atomic Time**

Role of the International Committee of Weights and Measures concerning International Atomic Time.

##### **RESOLUTION 1**

The 14th General Conference of Weights and Measures,

##### **CONSIDERING**

that the second, unit of time of the International System of Units, has been defined since 1967 according to a natural atomic frequency and no longer according to time scales furnished by astronomical movements;

that the need of an International Atomic Time Scale TAI is a consequence of the definition of the atomic second;

that many international organizations have assured and continue to assure with success the establishment of time scales based on astronomical movements, particularly by grace of the permanent services of the International Time Bureau (BIH);

that the BIH has begun to establish an atomic time scale of which the qualities are recognized and which have proven its utility;

that the atomic frequency standards serving as the realization of the second have been considered

and should continue to be by the International Committee of Weights and Measures assisted by a consultative committee and that the unit interval of the International Atomic Time Scale ought to be the second realized in conformance with its atomic definition;

that all the competent international scientific organizations and the active national laboratories in this domain have expressed the desire that the International Committee and the General Conference of Weights and Measures give a definition of International Atomic Time and contribute to the establishment of the International Atomic Time Scale;

that the utility of International Atomic Time necessitates a close coordination with the time scales based on astronomical movements asks of the International Committee of Weights and Measures

1. to give a definition of International Atomic Time\*.
2. to take the necessary steps in accord with the interested international organizations in order that the scientific competence and the means of action existing be best utilized for the realization of the International Atomic Time Scale, and in order that the needs of users of TAI be satisfied.

Arrangements with the Bureau International de l'Heure concerning International Atomic Time.

##### **RESOLUTION 2**

The 14th General Conference on Weights and Measures,

##### **CONSIDERING—**

that an International Atomic Time Scale ought to be placed at the disposition of users;

that the Bureau International de l'Heure has proven that it is capable to assure this service;

**EXPRESSES HOMAGE** to the Bureau International de l'Heure for the work it has already accomplished;

**ASKS** of national and international institutions of good will to continue and, if possible, augment the aid that they have given to the Bureau International de l'Heure for the benefit of the international scientific and technical community;

**AUTHORIZES** the International Committee of Weights and Measures to conclude with the Bureau International de l'Heure the arrangements necessary for the realization of the International Atomic Time Scale as defined by the Committee International.

\*CGPM, *Comptes Rendus des Séances de la Quatorzième Conférence Générale des Poids et Mesures* (Proceedings of the Sessions of the 14th General Conference of Weights and Measures) (Paris, France, October 4-8, 1971), pp. 77-78 (BIPM, Sèvres, France, 1972) (in French, see page 27).

† English translation.

\*In anticipation of this request, the International Committee of Weights and Measures has charged the Consultative Committee for the Definition of the Second to prepare a definition of International Atomic Time. This definition, approved by the International Committee at its 59th Session, October 1970, is as follows: "International Atomic Time is the time reference coordinate established by the Bureau International de l'Heure on the basis of atomic clock readings functioning in diverse establishments conforming to the definition of the second, unit of time of the International System of Units."

**1.A.3.b. Resolutions Adopted by the 14th General Conference of Weights and Measures (CGPM) in October 1971 \***

**RÉSOLUTIONS ADOPTÉES**

**PAR LA 14<sup>e</sup> CONFÉRENCE GÉNÉRALE**

**Temps Atomique International**

**Rôle du Comité International des Poids et Mesures concernant le Temps Atomique International**

**RÉSOLUTION 1**

*La Quatorzième Conférence Générale des Poids et Mesures,*

**CONSIDÉRANT**

*que la seconde, unité de temps du Système International d'Unités, est définie depuis 1967 d'après une fréquence atomique naturelle, et non plus d'après des échelles de temps fournies par des mouvements astronomiques,*

*que le besoin d'une échelle de Temps Atomique International (TAI) est une conséquence de la définition atomique de la seconde,*

*que plusieurs organisations internationales ont assuré et assurent encore avec succès l'établissement des échelles de temps fondées sur des mouvements astronomiques, particulièrement grâce aux services permanents du Bureau International de l'Heure (B. I. H.),*

*que le Bureau International de l'Heure a commencé à établir une échelle de temps atomique dont les qualités sont reconnues et qui a prouvé son utilité,*

*que les étalons atomiques de fréquence servant à la réalisation de la seconde ont été considérés et doivent continuer de l'être par le Comité International des Poids et Mesures assisté d'un Comité Consultatif, et que l'intervalle unitaire de l'échelle de Temps Atomique International doit être la seconde réalisée conformément à sa définition atomique,*

*que toutes les organisations scientifiques internationales compétentes et les laboratoires nationaux actifs dans ce domaine ont exprimé le désir que le Comité International et la Conférence Générale des Poids et Mesures donnent une définition du Temps Atomique International, et contribuent à l'établissement de l'échelle de Temps Atomique International,*

*que l'utilité du Temps Atomique International nécessite une coordination étroite avec les échelles de temps fondées sur des mouvements astronomiques,*

**DEMANDE au Comité International des Poids et Mesures**

**1<sup>o</sup> de donner une définition du Temps Atomique International (1);**

---

(1) En prévision de cette demande, le Comité International des Poids et Mesures avait chargé son Comité Consultatif pour la Définition de la Seconde de préparer une définition du Temps Atomique International. Cette définition, approuvée par le Comité International à sa 59<sup>e</sup> session (octobre 1970), est la suivante :

*\* Le Temps Atomique International est la coordonnée de repérage temporel établie par le Bureau International de l'Heure sur la base des indications d'horloges atomiques fonctionnant dans divers établissements conformément à la définition de la seconde, unité de temps du Système International d'Unités. \**

---

\* CGPM, *Comptes Rendus des Séances de la Quatorzième Conférence Générale des Poids et Mesures* (Proceedings of the Sessions of the 14th General Conference of Weights and Measures) (Paris, France, October 4-8, 1971), pp. 77-78 (BIPM, Sèvres, France, 1972) (in French).

2° de prendre les mesures nécessaires, en accord avec les organisations internationales intéressées, pour que les compétences scientifiques et les moyens d'action existants soient utilisés au mieux pour la réalisation de l'échelle de Temps Atomique International, et pour que soient satisfaits les besoins des utilisateurs du Temps Atomique International.

Arrangements avec le Bureau International de l'Heure concernant le Temps Atomique International

RÉSOLUTION 2

*La Quatorzième Conférence Générale des Poids et Mesures,*

CONSIDÉRANT

*qu'une échelle de Temps Atomique International doit être mise à la disposition des utilisateurs,*

*que le Bureau International de l'Heure a prouvé qu'il est capable d'assurer ce service;*

REND HOMMAGE au Bureau International de l'Heure pour l'œuvre qu'il a déjà accomplie;

DEMANDE aux institutions nationales et internationales de bien vouloir continuer, et si possible augmenter, l'aide qu'elles donnent au Bureau International de l'Heure, pour le bien de la communauté scientifique et technique internationale;

AUTORISE le Comité International des Poids et Mesures à conclure avec le Bureau International de l'Heure les arrangements nécessaires pour la réalisation de l'échelle de Temps Atomique International à définir par le Comité International.

**ANNEX 1.B**  
**STANDARD FREQUENCY AND TIME BROADCAST AGREEMENTS**

**Contents**

	Page
1.B.1. CCIR Recommendation 460.....	31
1.B.2. CCIR Report 517.....	32

## **I.B.1. CCIR Recommendation 460\***

### **RECOMMENDATION 460**

#### **STANDARD-FREQUENCY AND TIME-SIGNAL EMISSIONS**

**(Question 1/7)**

The C.C.I.R.,

(1970)

##### **CONSIDERING**

- (a)* the desirability of eliminating all offsets from nominal values in the carrier frequencies and in the time signals;
- (b)* the desirability of disseminating on a world-wide basis precise time intervals in conformity with the definition of the second (SI), as adopted by the 13th General Conference of Weights and Measures (1967);
- (c)* the continuing need of many users for Universal Time (UT);

##### **UNANIMOUSLY RECOMMENDS**

1. that, from a specified date, carrier frequencies and time intervals should be maintained constant and should correspond to the adopted definition of the second;
2. that the transmitted time scale should be adjusted when necessary in steps of exactly one second to maintain approximate agreement with Universal Time (UT);
3. that the standard-frequency and time-signal emissions should contain information on the difference between the time signals and Universal Time (UT);
4. that detailed instructions on the implementation of this Recommendation be adopted by Study Group 7 after consideration of the report of Interim Working Party 7/1;
5. that the standard-frequency and time-signal emissions should conform to §§ 1, 2, 3 and 4 above from 1 January 1972, 0000 h UT;
6. that this document be transmitted by the Director, C.C.I.R., to all Administrations Members of the I.T.U., to the Scientific Unions (I.A.U., I.U.G.G., U.R.S.I., I.U.P.A.P.), and other organizations such as B.I.H., C.I.P.M., I.C.A.O. and I.M.C.O.

---

\*CCIR, "Standard-frequency and time-signal emissions," (Recommendation 460), in *XIIIth Plenary Assembly CCIR*, (New Delhi, India, 1970), III, p. 227 (ITU, Geneva, Switzerland, 1970).

REPORT 517\*

STANDARD-FREQUENCY AND TIME-SIGNAL EMISSIONS

Detailed instructions by Study Group 7 for the implementation  
of Recommendation 460 concerning the improved Coordinated Universal Time (UTC) System,  
valid from 1 January 1972

(Question 1/7, Resolution 53)

(1971)

1. The XIIth Plenary Assembly of the C.C.I.R. adopted unanimously Recommendation 460. According to § 4 of this Recommendation, Study Group 7 was entrusted with the task of formulating the detailed instructions for its implementation on 1 January 1972.

Study Group 7 met from 17-23 February 1971 and adopted the following text for this purpose:

- 2.
- 2.1 A special adjustment to the standard-frequency and time-signal emissions should be made at the end of 1971 so that the reading of the UTC scale will be 1 January 1972, 0<sup>h</sup> 0<sup>m</sup> 0<sup>s</sup> at the instant when the reading of Atomic Time (AT) indicated by the Bureau international de l'Heure (B.I.H.) will be 1 January 1972, 0<sup>h</sup> 0<sup>m</sup> 10<sup>s</sup>. The necessary adjustments to emissions which are in accordance with Recommendation 374-2 will be specified and announced in advance by the B.I.H.
- 2.2 The departure of UTC from UT1 should not normally exceed 0.7 s\*\*.
- 2.3 Inserted seconds should be called positive leap seconds and omitted seconds should be called negative leap seconds.
- 2.4 A positive or negative leap second, when required, should be the last second of a UTC month, preferably 31 December and/or 30 June. A positive leap second begins at 23<sup>h</sup> 59<sup>m</sup> 60<sup>s</sup> and ends at 0<sup>h</sup> 0<sup>m</sup> 0<sup>s</sup> of the first day of the following month. In the case of a negative leap second, 23<sup>h</sup> 59<sup>m</sup> 58<sup>s</sup> will be followed one second later by 0<sup>h</sup> 0<sup>m</sup> 0<sup>s</sup> of the first day of the following month. (See Annex I).

---

\* This Report was adopted unanimously.

\*\* Universal Time

In applications in which errors of a few hundredths of a second cannot be tolerated, it is necessary to specify the form of Universal Time (UT), referred to in Recommendation 460, which should be used.

UT1 is a form of UT in which corrections have been applied for the effects of small movements of the Earth relative to the axis of rotation.

UT2 is UT1 corrected for the effects of a small seasonal change in the rate of rotation of the Earth.

UT1 correspond directly with the angular position of the Earth around its axis of rotation, and is used in this document. GMT may be regarded as the general equivalent of UT1.

---

†CCIR, "Detailed instructions by Study Group 7 for the implementation of Recommendation 460 concerning the improved coordinated universal time (UTC) system, valid from 1 January 1972" in *XIIth Plenary Assembly CCIR*, (New Delhi, India, 1970) III, p. 258 a-d (ITU, Geneva, Switzerland, 1970).

- 2.5 The B.I.H. should decide upon and announce the occurrence of a leap second; such an announcement is to be made at least eight weeks in advance.
- 2.6 The time signals of standard-frequency and time-signal emissions should be kept as close to UTC as possible, with a maximum deviation of one millisecond.

3.

- 3.1 The approximate value of the difference UT1 minus UTC, as disseminated with the time signals should be denoted DUT1,  
where  $DUT1 \approx UT1 - UTC$ .

DUT1 may be regarded as a correction to be added to UTC to obtain an approximation of UT1.

- 3.2 The values of DUT1 should be given in integral multiples of 0.1 s. The B.I.H. is requested to determine and to circulate one month in advance the value of DUT1. Administrations and organizations should use the B.I.H. value of DUT1 for standard-frequency and time-signal emissions whenever possible, and are requested to circulate the information as widely as possible in periodicals, bulletins, etc.
- 3.3 Where DUT1 is disseminated by code, the code should be in accordance with the following principles:
  - the magnitude of DUT1 is specified by the number of emphasized seconds markers and the sign of DUT1 is specified by the position of the emphasized seconds markers with respect to the minute marker. The absence of emphasized markers indicates  $DUT1 = 0$ ;
  - the coded information should be emitted after each identified minute.

Full details of the code are given in Annex II.

- 3.4 Alternatively DUT1 may be given by voice announcement or in morse code.
- 3.5 In addition, UT1-UTC may be given to the same or higher precision by other means, for example, in morse or voice announcements, by messages associated with maritime bulletins, weather forecasts, etc.; announcements of forthcoming leap seconds may also be made by these methods.
- 3.6 The B.I.H. is requested to continue to publish in arrears definitive values of the differences UT1-UTC, UT2-UTC and AT (B.I.H.)-UTC.



ANNEX I

DATING OF EVENTS IN THE VICINITY OF A LEAP SECOND

(Taken from § 2.4 of the Report)

A positive or negative leap second, when required, should be the last second of a UTC month, preferably 31 December and/or 30 June. A positive leap second begins at 23<sup>h</sup> 59<sup>m</sup> 60<sup>s</sup> and ends at 0<sup>h</sup> 0<sup>m</sup> 0<sup>s</sup> of the first day of the following month. In the case of a negative leap second, 23<sup>h</sup> 59<sup>m</sup> 58<sup>s</sup> will be followed one second later by 0<sup>h</sup> 0<sup>m</sup> 0<sup>s</sup> of the first day of the following month.

Taking account of what has been said in the preceding paragraph, the dating of events in the vicinity of a leap second shall be effected in the manner indicated in the following figures:

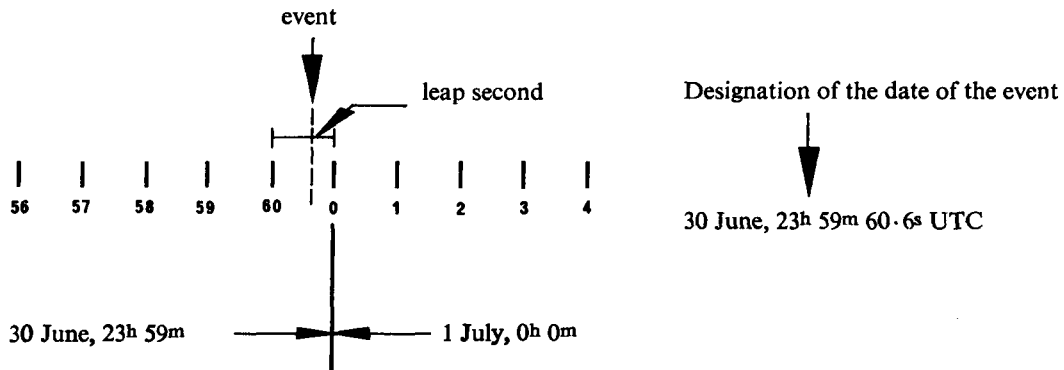

FIGURE 1  
*Positive leap second*

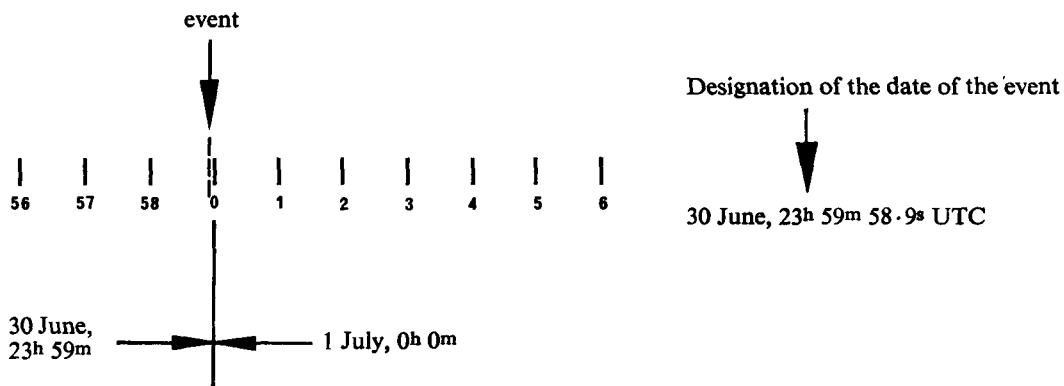

FIGURE 2  
*Negative leap second*

ANNEX II

CODE FOR THE TRANSMISSION OF DUT1

A positive value of DUT1 will be indicated by emphasizing a number (n) of consecutive seconds markers following the minute marker from seconds markers one to seconds marker (n) inclusive; (n) being an integer from 1 to 7 inclusive.

$$DUT1 = (n \times 0.1)s$$

A negative value of DUT1 will be indicated by emphasizing a number (m) of consecutive seconds markers following the minute marker from seconds marker nine to seconds marker (8 + m) inclusive; (m) being an integer from 1 to 7 inclusive.

$$DUT1 = -(m \times 0.1)s$$

A zero value of DUT1 will be indicated by the absence of emphasized seconds markers.

The appropriate seconds markers may be emphasized, for example, by lengthening, doubling, splitting, or tone modulation of the normal seconds markers.

Examples:

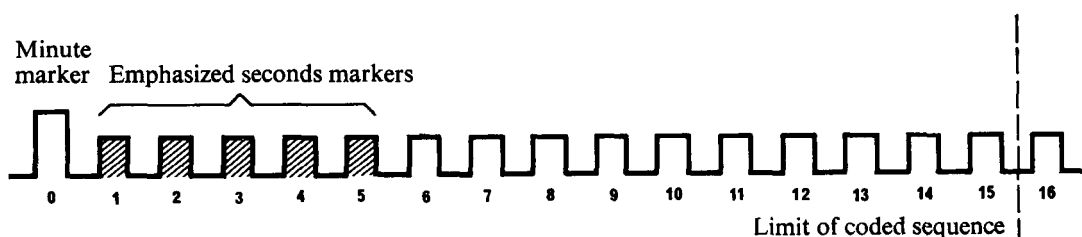

FIGURE 3  
 $DUT1 = +0.5 s$

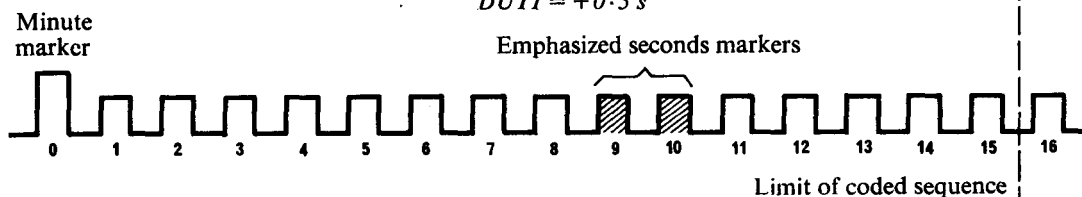

FIGURE 4  
 $DUT1 = -0.2 s$

## ANNEX 1.C

### RESULTS OF 6TH SESSION OF CONSULTATIVE COMMITTEE FOR DEFINITION OF THE SECOND (CCDS)\*

#### Contents

	Page
1.C.1. Recommendations of the 6th Session of CCDS.....	39
1.C.2. The Work of the Bureau International de l'Heure for the Improvement of International Atomic Time (TAI).....	39

---

\*Guinot, B., (Reporter), "Minutes of 6th Session Consultative Committee for the Definition of the Second, *Sixieme rapport du comité consultatif pour la définition de la seconde au comité international des poids et mesures* (CIPM, 6<sup>e</sup> Session, Paris, France, July 6-7, 1972) (Bur. Internat. des Poids et Mesures, Sèvres, France, 1972) (in French).

**I.C.1. Recommendations of the 6th Session  
of CCDS\***

**Recommendations of the Consultative  
Committee for the Definition of the Second**

presented to the

**International Committee of Weights and  
Measures**

Sending to the Bureau International de l'Heure  
Information concerning the individual clocks

**RECOMMENDATION S-1 (1972)**

The Consultative Committee for the Definition  
of the Second,

CONSIDERING that the Bureau International  
de l'Heure (BIH) would be able to improve the uni-  
formity of International Atomic Time (TAI) if  
it received more complete information.

RECOMMENDS that the organizations concern-  
ing themselves with the establishment of time  
scales furnish to the BIH at its request and in  
the form which it will specify the results of compar-  
isons of individual atomic clocks as well as all perti-  
nent information.

Consequence of the adoption of International  
Atomic Time for time scales used in current life

**RECOMMENDATION S-2 (1972)**

The Consultative Committee for the Definition of  
the Second,

CONSIDERING

1. That the scale of international atomic time  
(TAI) implies a counting of seconds from its origin  
(January 1958).

2. That the scales of time in use for the current  
life which are based on the second of SI will con-  
tinue to involve years, months, days, hours, and  
minutes,

PROPOSES

That these questions be studied in collaboration  
with interested organizations, in particular the Inter-  
national Astronomical Union.

**Declaration of the Consultative Committee  
for the Definition of the Second**

presented to the

**International Committee of Weights and  
Measures**

On the legal usage of Universal Coordinated Time

\* English translation.

The Consultative Committee for the Definition  
of the Second,

CONSIDERING the recommendations of the In-  
ternational Radio Consultative Committee (CCIR)  
and of the International Astronomical Union  
(IAU) for an improved system of Coordinated  
Universal Time serving for broadcast of time signals.

TAKES NOTE that the quasi universal ac-  
ceptance of UTC can furnish a solid basis to a  
future recommendation of the General Conference  
of Weights and Measures on the time system ac-  
ceptable internationally.

**I.C.2. The Work of the Bureau International  
de l'Heure for the Improvement of Interna-  
tional Atomic Time (TAI)\***

**1. Current determination of TAI**

During the time of studies mentioned above,  
TAI will continue to be established by the method  
currently in use. In the eventuality where other  
local time scales become usable, they will be in-  
corporated with the weight unity.

**2. Preparation to employ the data of individual  
clocks**

This operation will be described as follows:

a. About October 1972 inquests on the condi-  
tions of use of clocks within the time services (the  
BIH will reserve the right to use only the clocks  
exploited in satisfactory condition). Requests by  
the BIH of comparisons of clocks for all the year  
1972 in a specified format (punched cards and  
perforated tapes would be able to be used).

b. End of 1972, beginning of 1973. Reduction of  
the data of clocks with the method called ALGOS  
which contains a weighting of clocks according to  
their mean bimonthly rate.

c. Beginning of 1973. Comparative study of the  
current results and of the results of ALGOS.  
Balance sheet on the time of exploitation of ALGOS.

d. April-May 1973. Presentation of results of the  
study to the President of CCDS, the President of  
the Directing Board of the BIH, as well as to con-  
cerned laboratories. If the new method appears to  
improve TAI, which is very probable according to  
the studies which have already been made, its  
adoption will be proposed with immediate appli-  
cation. It seems thus possible that the new method  
be adopted within about 1 year.

NOTE:

- The calendar proposed is approximate.

- In that which preceded, one will not intention-  
ally modify the duration of the unit interval of TAI.  
One will insure that this duration will not be modi-  
fied during the passage from one method to the  
other.

- One will propose later a method designed to in-  
sure simultaneously the stability in mean term  
(a few years) and accuracy.

—In the new method, the results will be presented in the same form as at present. That is to say, that one will give every 10 days the values of  $TAI-TA(i)$  and  $TUC-TUC(i)$ ; and that these results will

appear only every two months. Further, one will furnish to the concerned laboratories the mean frequencies relative to TAI and the weights of each of the clocks.

## CHAPTER 2 – PART A

### STATE OF THE ART – QUARTZ CRYSTAL UNITS AND OSCILLATORS

Eduard A. Gerber,<sup>†</sup> IEEE Fellow and Roger A. Sykes,<sup>‡</sup> IEEE Fellow

#### Contents

	Page
2A.1. Introduction.....	43
2A.2. Quartz Crystal Units.....	44
2A.2.1. Equivalent Circuit.....	44
2A.2.2. Vibrator Types.....	44
2A.2.3. Enclosures.....	44
2A.2.4. Quartz Material.....	45
2A.2.5. Modes of Motion.....	46
2A.3. Frequency Stability as a Function of:	
2A.3.1. Temperature.....	48
2A.3.2. Time (Aging).....	48
2A.3.3. Stress, Vibration and Acceleration.....	50
2A.3.4. Drive Level.....	50
2A.3.5. Nuclear Effects.....	51
2A.4. Quartz Crystal Controlled Oscillators.....	52
2A.4.1. General Purpose Oscillators.....	52
2A.4.2. Temperature Compensated Oscillator.....	52
2A.4.3. Voltage Controlled Oscillator.....	52
2A.4.4. Oscillators for Severe Environment.....	52
2A.4.5. Precision Oscillators.....	52
2A.4.6. Short-Term Stability.....	54
2A.5. Conclusions.....	55
2A.6. References.....	55

<sup>†</sup> Electronics Components Laboratory, U.S. Army Electronics Command, Ft. Monmouth, NJ 07703.  
<sup>‡</sup> Bell Telephone Laboratories, Inc., Allentown, PA 18103.

"Arts and sciences are not cast in a mould, but are found and perfected by degrees, by often handling and polishing . . ."

Montaigne,  
*Essays*, Bk.ii. Ch. 12

The paper discusses progress made in the field of quartz crystal units and quartz crystal controlled oscillators over the past few years. The field is reviewed in general, but several accomplishments which are thought to be of special importance, are discussed in detail. These subjects include, among others, quartz vibrator characteristics and enclosures, modes of motion including the "trapped energy" concept and long-term drift (aging) of crystal units. The characteristics of various types of oscillators are reviewed including temperature compensated and high precision types, and the problem of short-term stability of crystal controlled oscillators is discussed. Precision oscillators are available today with a daily drift rate as low as a few parts in  $10^{11}$  and a short time stability better than a few parts in  $10^{10}$  for a time period of one millisecond.

**Key words:** Aging (time); crystal material; crystal modes of motion; crystal vibration effects; frequency stability; oscillator drift; precision quartz oscillators; quartz crystal oscillators; short term stability; temperature compensated oscillator.

## 2A.1. INTRODUCTION

THE QUARTZ CRYSTAL controlled oscillator was developed with the advent of radio broadcasting in the early 1920's, giving for the first time a highly stable radio-frequency source. Similar to all mechanical vibrators in this period, there were many factors that controlled the stability of such oscillators, including the electrical circuit and amplifying device in which the quartz crystal unit was the principal frequency controlling element. Early developments involving quartz crystals to improve frequency stability were centered around the low-frequency types, since they were the best cases for known analytical methods. In order of their development they were: the second overtone of an X-cut extensional bar, the ring vibrator, and the GT-cut quartz plate, all of which operated at 100 kHz. Progress in these developments is best illustrated by the fact that early experimental data on crystal controlled oscillators showed the variation of a pendulum clock due to the gravitational effects of the moon and, later, minor irregularities in the earth's rotational period.

Following the development of the high-frequency plated crystal units during the latter part of World War II, an attempt was made to determine the stability and drift rates of these crystal units by employing in their design and fabrication all the known techniques of the 100-kHz GT. This development, initially started for the Air Force on the NAVARHO project and continued mainly under sponsorship of the U. S. Army, resulted in a high-precision glass enclosed fifth overtone AT crystal plate at 5 and 2.5 MHz for use in precision oscillators [1], [2]. Most of this work was done in the ten-year interval, 1950 to 1960. Associated with the crystal development was the corresponding temperature control and circuit development to give a net improvement in frequency stability and, in particular, low, long-term drift rate. Immediately following the R and D program, the U. S. Army initiated several manufacturing development contracts to make these types of crys-

tal units available to the industry for improved precision oscillators. This last step made it possible to obtain commercial precision oscillators having low drift rates and high stability. One can obtain on the market today precision oscillators capable of daily drift rates as low as a few parts in  $10^{11}$ , with a short time stability better than a few parts in  $10^{10}$  for time periods as small as one millisecond. A stabilization period of one to six weeks is often required to achieve these low drift rates. Recent developments utilizing thermocompression bonds for the vibrator mounting and cold welded metal enclosures have indicated that a further material reduction in the stabilization period is possible.

It is important to point out that the above statements with reference to drift rate and stability apply to specially designed oscillators and crystal units, when continuously operated in controlled environments. There are, of course, needs for the generation of frequencies in the low-frequency end of the spectrum where the thickness shear mode obviously cannot be used, as well as in the very-high-frequency region where factors neglected in the 2.5- and 5-MHz units become of major importance. In addition, precision oscillators are required which must operate in severe mechanical and temperature environments, where the techniques and size employed in the 2.5- and 5-MHz units are not applicable.

Except for long-term nonperiodic fluctuations of continuously operating oscillators, the principal contributions to medium- and long-term stability are made by the particular crystal unit used. Therefore, most of the emphasis in this discussion will be concentrated on the characteristics and performance of the various types and designs of crystal units currently employed for frequency control. The reason for this is that the very low coupling, together with the high  $Q$ 's attainable with precision crystal units, have made it possible to reduce the effects of other circuit components on the frequency of oscillation to a negligible level when the best available components and circuit designs are employed. Cases in which this is not strictly true will be discussed in the section on oscillators.



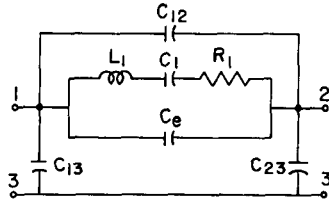

Fig. 1. Equivalent circuit of a quartz crystal unit.

## 2A.2. QUARTZ CRYSTAL UNITS

### 2A.2.1. Equivalent Circuit

The electrical equivalent of a quartz crystal unit is shown in Fig. 1 [3], where the motional parameters of the crystal vibrator are  $L_1$ ,  $C_1$ , and  $R_1$ , and the capacitance of the electrodes with quartz as a dielectric is shown as  $C_e$ . The other capacitances shown,  $C_{12}$ ,  $C_{13}$ , and  $C_{23}$ , are of a distributed nature as well as that between the electrodes and surrounding ground such as a metal holder. When shown as a two-terminal network, as in most specifications, the shunt capacitance of a crystal unit is normally designated  $C_0$ . It is obvious in this case how  $C_0$  would be defined once the connection of the crystal unit in a particular circuit has been determined. The assignment of the distributed capacitances and how they are combined with the rest of the elements of a circuit in which the crystal unit is used has led to considerable misunderstanding, as well as to a lack of correlation in the measurement of the ratio of capacitances or inductance [3].

### 2A.2.2. Vibrator Types

Figure 2 illustrates the modes of motion that are used in practically all crystal units on the market today. To cover a wide frequency range from a few hundred hertz to over 200 MHz, quartz bars or plates are used in the flexural, extensional, and shear modes of motion. At 1 is shown the lowest frequency of flexure mode in which the motion can be in the length-thickness or the length-width plane, and can be used at frequencies as high as 100 kHz. Essentially the same form of bar, but in the extensional mode, is shown at 2, where it is used at frequencies as low as 60 kHz and as high as 300 kHz. A face shear mode is shown at 3 and 4 in which at 3 a square and sometimes circular plate is used, and at 4 a rectangular plate is used with critical ratios of the width to length. The shear mode shown at 4 is often referred to as width shear. The shear mode shown at 5 is a thickness shear. This mode is used over the frequency range from 0.5 MHz to 20 MHz, where overtones of this same mode, as shown at 6, for the third overtone case, will operate over the frequency range normally from 10 to 250 MHz. In some particular cases, the low-frequency types illustrated at 1 and 2 are used at higher mechanical overtones. To obtain the best characteristics and, in particular, those as a function of temperature, certain orientations with respect to the crystallographic

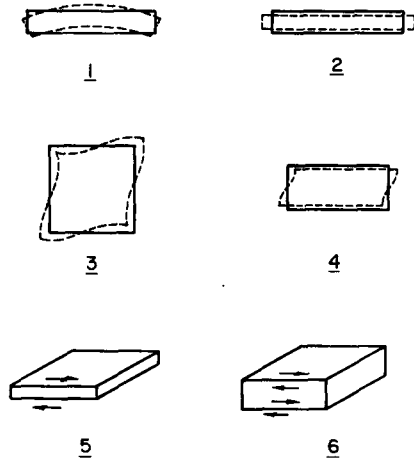

Fig. 2. Basic modes in quartz crystal vibrators. 1 Flexure mode. 2 Extensional mode. 3 and 4 Face shear modes. 5 and 6 Thickness shear modes.

TABLE I  
DESIGNATION OF "QUARTZ VIBRATORS"

Vibrator Designation	Usual Reference	Mode of Vibration	Frequency Range
A	AT cut	Thickness Shear	0.5 to 250 MHz
B	BT	Thickness Shear	1 to 30 MHz
C	CT	Face Shear	300 to 1000 kHz
D	DT	Face or Width Shear	200 to 750 kHz
E	+5°X	Extensional	60 to 300 kHz
F	-18°X	Extensional	60 to 300 kHz
G	GT	Extensional	100 to 500 kHz
H	+5°X	Length-Width Flexure	10 to 100 kHz
J	+5°X (2 plates)	Duplex Length-Thickness Flexure	1 to 10 kHz
M	MT	Extensional	60 to 300 kHz
N	NT	Length-Width Flexure	10 to 100 kHz
K	X-Y bar	Length-Width Flexure or Length-Thickness Flexure	2 to 20 kHz

axes of quartz have been developed, and are shown in Table I [4]. A designation system has been established to give these various quartz vibrators a convenient "handle" for further discussion.

### 2A.2.3. Enclosures

The characteristics and performance of the various crystal vibrators are controlled largely by the mounting system used, together with the enclosure. The types of holders that are now in common use, together with those recently developed, are shown in Fig. 3. The holders HC-6, HC-13, and HC-18, developed during and after World War II, are of such size that crystal vibrators as

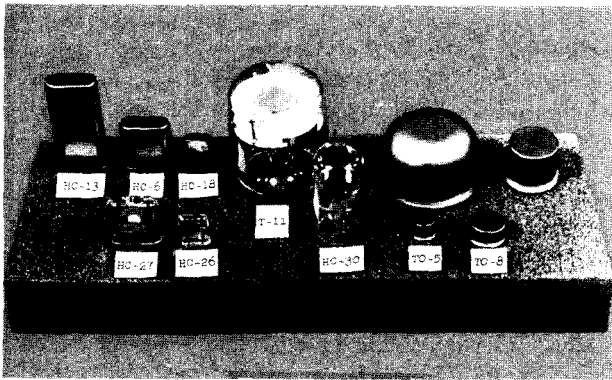

Fig. 3. Quartz crystal unit holders.

shown in Table I may be mounted within them to provide frequency coverage from a few kilohertz to 200 MHz. For crystal units of moderate precision, these holders have served to meet the bulk of the requirements since about 1948, and even today represent most of the crystal units produced. The major problem with this type of holder has been the sealing of the cover to the base by soldering. During this sealing process, a small amount of contamination is introduced within the enclosure even with the introduction of a breather hole that is later sealed. To overcome this difficulty, all-glass holders of the HC-6 and HC-18 dimensions have been developed and are shown as HC-26 and HC-27 [5]. They are used principally for the high-frequency thickness shear-type crystal units. In addition, the HC-30 and its larger counterpart, T-11, are all-glass holders used for high-frequency overtone precision type crystal units [1], [6]. They are the same as those used in the vacuum tube industry, and are of the drop seal type using the T-5½ and T-11 glass bulbs. The principal difference between these various glass types is that, with the drop seal design, eutectic solder may be used in the mounting system for the quartz vibrator, whereas in the case of the HC-26 and HC-27 enclosures, high temperature bonding agents such as silver paste and cements must be used. Also with the vacuum tube types, more appropriate annealing procedures to reduce glass strain may be employed. The vacuum tube-type structure, however, can never be reduced to the small space needed for compatibility with equipment using HC-6 and HC-18 metal types. The principal advantage of any of the glass types is that they are more amenable to cleaning techniques. As a result, with normal processing, there will usually be lower contamination within the enclosures. Glass types have been developed to high perfection and are being used for medium precision applications in single sideband equipment, both temperature controlled and temperature compensated. Some experiments performed a few years ago with special control of the process on HC-6 and HC-18 type enclosures indicated that nearly as good stability might be obtained with the metal enclosure. The principal

problem would be maintenance of control of process. Recent developments employing cold welding and utilizing sizes compatible with transistor enclosures are also shown in Fig. 3 [7]. The particular advantage of these holders is in their ability to be used with any of the crystal vibrators shown in Table I, making use of soldered mounting systems, and yet be sealed at low temperature by the cold welding process, thus yielding less contamination within the enclosure and maintaining high reliability of seal. For vibrators requiring greater height, longer cans are used on the bases shown. Also, in attempts to miniaturize the enclosure as much as possible, there have been recent developments to produce holders similar to the TO-5 transistor enclosure, as shown in Fig. 3, but having a diameter of 0.250 inch and height of 0.070 inch. The seal is made by the electron beam welding process [8].

#### 2A.2.4. Quartz Material

During the past few years, synthetic quartz has become available from a number of commercial sources. The proper choice of seeds and growth pattern enables the manufacturer to cut vibrator plates with a minimum of waste [9]. Recently, much effort has gone into the attempt to improve the  $Q$  obtainable from synthetic quartz. The maximum  $Q$  value obtainable is limited by the internal friction of the material. Figure 4 shows some early measurements of the internal friction of natural quartz over a wide temperature range obtained by measurement of the  $Q$  of a 5-MHz fifth overtone glass enclosed A vibrator [10], [11]. This particular crystal unit construction has been used for the measurement of the  $Q$  of synthetic and natural quartz because its unique construction suggests that most of the measurable loss is in the vibrator material, and not in the mounting system. There is a sharp relaxation peak at 50°K plus a general background which has a maximum at 20°K. It has been shown [12]–[14] that the peak of 50°K is due to a sodium impurity. This peak varies with different specimens of material and can be removed by electrolytically “sweeping out” the impurity or replacing it by lithium [15] in the growing solution. It has been shown that the  $Q$  of synthetic quartz can thus be improved to a value equivalent to natural quartz [16], [17]. Causes of the impurity peaks and the role which sodium and lithium play have been very well explained by setting up a model for this effect [18]. The background relaxation shown in Fig. 4 has been explained as being a phonon-phonon loss; i.e., a direct conversion of acoustic waves into thermal energy [11]. Further work in the field of quartz material has been accomplished; on the specific problems of the change of elastic constants as a function of an applied dc field [19], [20], the variation of dielectric constants as a function of temperature over a range from 20 to 70°C [21], and the anomalous weakness of synthetic quartz whose strength drops rapidly at 400°C [22]. The origin of oscillations which have been experienced during quartz electrolysis and the

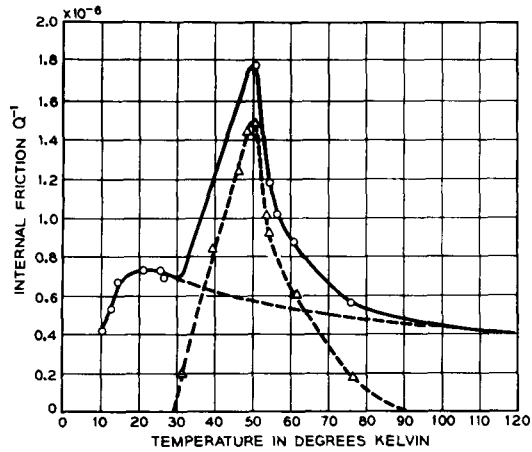

Fig. 4. Friction losses in quartz solid curve represents measured internal friction consisting of relaxation peak and background loss (dashed curves).

study of the mechanism of electrical conductivity in quartz has been the object of further studies [23], [24]. Recent correlation between the infrared absorption in synthetic quartz and its acoustic loss has been a material aid in rapidly determining the  $Q$  of newly grown material [25].

Since the acoustic loss in the vibrator is inversely proportional to the elastic constant, a  $B$  vibrator, with its elastic constant more than twice as high as that of an  $A$  vibrator, offers higher  $Q$  values. A  $Q$  of  $1 \cdot 10^6$  has been measured at 15 MHz [26].

#### 2A.2.5. Modes of Motion

Over a number of years, the resonance pattern of both low- and high-frequency-type crystal vibrators has been measured experimentally to determine the types of motion in bars and plates to obtain a better understanding of the complex resonance phenomena observed in specific crystal units. This background of work has enabled the mathematicians to set up the boundary conditions to solve this complex problem. Tremendous progress has been made, especially at Columbia University, in calculating the various modes of motion in crystal plates and determining their amplitude distribution. A comprehensive theory of vibration of crystalline bars and plates and, concurrently, of the mathematical methods and tools for dealing with the solutions of these equations has been developed. A study of three references [27]–[29] will give a good indication of what has been accomplished in this field to date. The results of these studies at Columbia University are closely tied to many of the practical problems we have today; e.g., the suppression of unwanted responses in crystal units for filters by contouring or by control of electrodes for “energy trapping” [30]. The concept of energy trapping means that containment of the vibrator energy in the electroded region of the crystal plate is due to a cutoff

phenomenon. If the outer portion has a frequency higher than that of the plated portion, the resulting energy of the vibrator is principally confined to the plated portion, and decreases exponentially with distance from the plated electrode. This energy containment concept is the basis for the design of singly resonant crystal units for application in filters at high frequencies [31]–[33]. Since the energy is confined principally to the electroded portion, several vibrators may be included on a single substrate of quartz. Critical parameters for applying the trapped energy concept are the diameter and thickness of the electrode relative to the thickness of the quartz plate. In general, when larger diameters are used with thinner electrodes, there is a less rapid decrease in energy away from the edge of the electrode. This allows low impedance units to be designed which have but a single response, and the limit is reached when the ohmic loss of the electrode materially affects the  $Q$ . In the case of high-frequency plates, a number of single electrode vibrators may be used in parallel on the same substrate to develop lower impedances. Mesa designs of crystal plates and tuning with insulating layers have been proposed [31] to simplify the frequency adjustment procedure. An illustration of the reduction in unwanted responses by the energy trapping principle is shown in Figs. 5(a) and 5(b) [32]. Similar degrees of suppression can be obtained for fundamental crystals as low as 6 or 7 MHz by electrode control; however, contouring in addition to electrode control may be necessary at lower frequencies.

Precise experimental methods have been devised to measure the distribution of amplitude or stress in a vibrating quartz plate. One of these has been the measurement of the degree of modulation of a light beam which is reflected from an area of selective reflection on a quartz crystal vibrating in thickness shear [34]. Methods of obtaining a picture of the amplitude distribution by using electrical probe techniques have yielded results which check very well with theory [35]. Visual observations have been accomplished by using the rotation of the optical index ellipsoid of a quartz crystal by its resonant modes [36]. Phenomenological theory in describing the effects of unwanted modes in quartz crystal units has been developed [37]. Material success has been achieved recently with the use of X-rays to study strain or displacement in vibrating crystal plates. This technique also shows imperfections in the material which result in lattice distortions [6], [38], [39]. Any motion resulting in a curvature of the lattice can easily be detected by the topographic X-ray method; Fig. 6 illustrates the degrees of sensitivity that may be obtained. This figure shows the various modes of motion of a 3.2-MHz contoured thickness shear vibrator with their relative responses. Each photograph of the crystal plate is of the same plate being driven at the various responses directly above and including the principal response at 3.2 MHz. Along the line marked  $-20$  dB are those

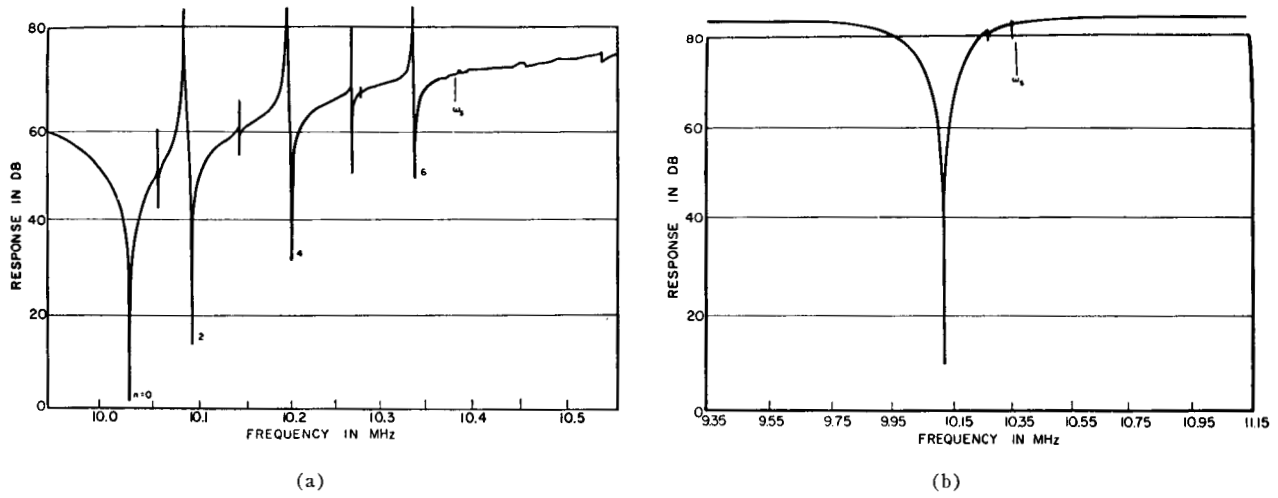

Fig. 5. Reduction in unwanted responses in a crystal vibrator by "trapped energy" principle. In (a), the response  $n=0$  is the main mode; the other responses are inharmonic overtones;  $\omega_c$  is the cutoff frequency.

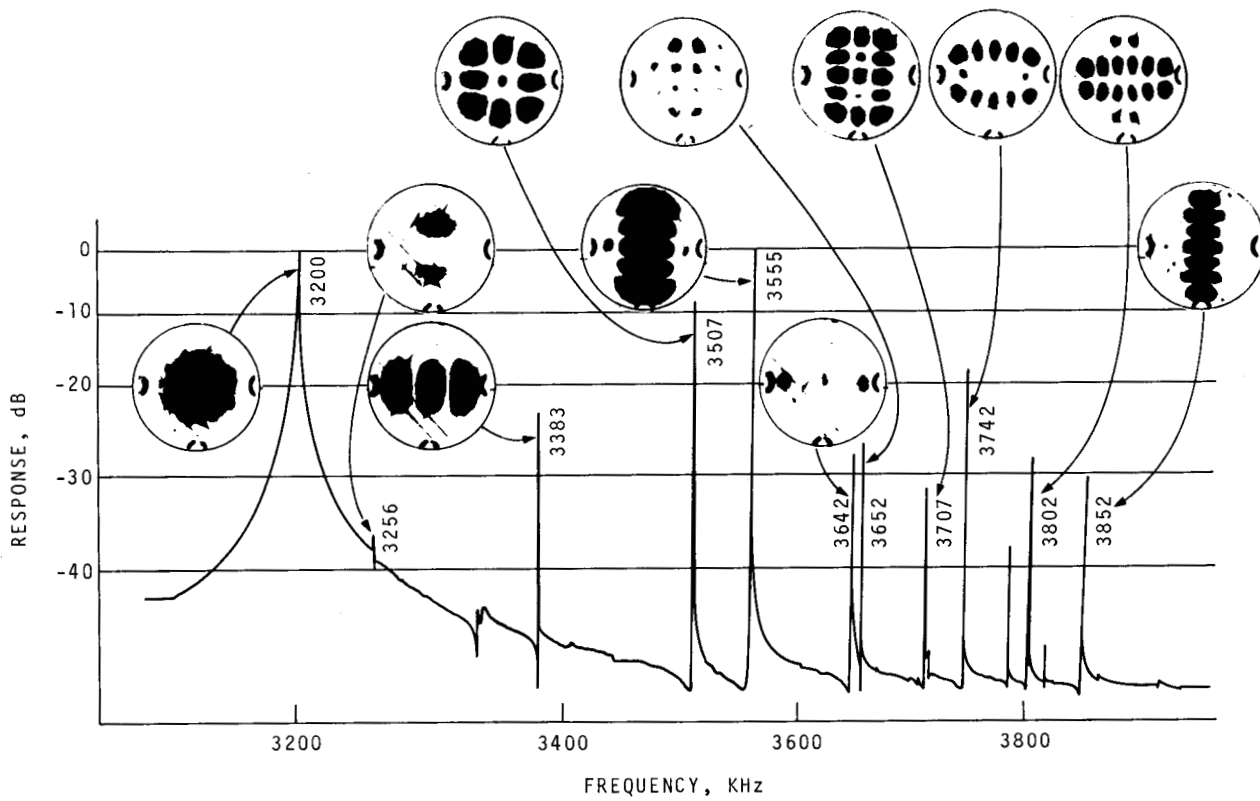

Fig. 6. Responses and distribution of strain in a contoured 3.2-MHz crystal vibrator.

responses that are functions primarily of the  $X$ -axis direction. Those along the 0-dB line are responses dependent upon  $Z'$ , where the group at the top of the figure are responses dependent upon both  $X$  and  $Z'$ . It will be noted that the same crystal imperfections show up in all photographs, indicating that the same plate was used. Also of interest are the dissymmetric modes shown at 3.256, 3.652, and 3.802 MHz, which piezoelectrically should not be driven with a single pair of electrodes. This can be accounted for only by imbalance in the drive mechanism or sufficient dissymmetry in the lattice. Strain patterns resulting from baked-on silver cement for the terminal connections are evident at three places on the periphery in each picture. All of the observed responses are shown in this figure, which means there is an abrupt termination of these responses above 3.852 MHz. This indicates that an energy-trapping mechanism is in operation here due to a combination of the electrode diameter and mass, as well as contour of the crystal plate. Using this technique, strain distribution in vibrating quartz plates is easily and quickly observed. Further experiments of this nature should greatly assist in obtaining a more complete mathematical solution to the various resonances observed in all types of quartz crystal vibrators. In addition, there is the source image distortion technique by X-rays [39] which clearly shows surface strain which is produced by various adherent platings with differing temperature coefficients from that of quartz as well as those strains produced by baked-on silver cements.

All of the high-frequency crystal units previously described and shown in Table I are excited by an electrical field  $Y'$  which is perpendicular to the major surfaces of the crystal plate. In  $A$  and  $B$  vibrators an electrical field parallel to the major surface may be used to couple to the thickness shear mode [40]-[42]. This may be accomplished by the deposition of electrodes which do not cover the central portion, the principal frequency determining part of the quartz plate. Since the most active central area of the crystal vibrator is not covered by any metal, a higher  $Q$  value and a better behavior with regard to sudden temperature changes are obtained. This will be discussed in more detail in the next section. The parallel field design results in a high impedance, low coupling device that is difficult to use for feedback control in an oscillator; however, a "composite field" arrangement [41] permits the lowering of the impedance of the crystal units.

## 2A.3. FREQUENCY STABILITY AS A FUNCTION OF:

### 2A.3.1. Temperature

The principal change in frequency of most crystal units is that resulting from ambient temperature changes. The temperature characteristics of some of the vibrators shown in Table I are shown in Fig. 7. Except for the  $A$  and  $G$  vibrators, the temperature behavior is parabolic in nature. While the curves shown have a

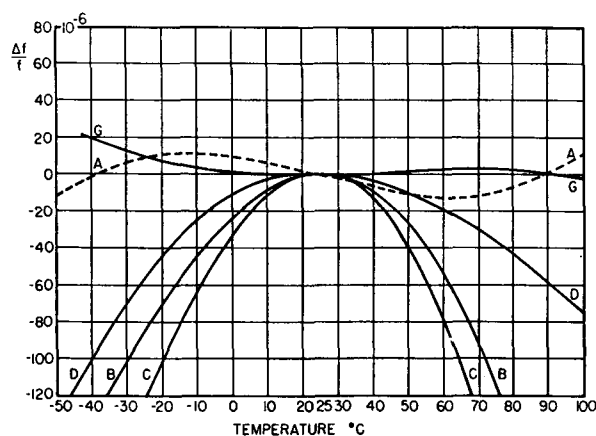

Fig. 7. Frequency-temperature characteristics of various quartz vibrators (for the explanation of letters ascribed to curves see Table I).

common inflection point near room temperature, in most cases the temperature for zero coefficient can be placed almost anywhere in the usable temperature range by change in orientation of the quartz plate with respect to the crystallographic axes. The  $G$  vibrator is unique in that its temperature characteristic may be altered after the plate has been cut to a given orientation, by proper choice of the length and width dimensions. The  $A$  vibrator characteristic is completely controlled by the orientation of the quartz plate. The two points of zero coefficient are nearly symmetric about room temperature. Therefore, an orientation may be chosen for small temperature ranges yielding a small overall frequency change. For wide temperature ranges such as  $-55^{\circ}\text{C}$  to  $+105^{\circ}\text{C}$ , a total frequency shift of  $\pm 0.002$  percent will result. By temperature compensation methods, the overall change in frequency may be reduced materially for most of the vibrators shown in Fig. 7. This will be covered in more detail in Section IV.

### 2A.3.2. Time (Aging)

The change in frequency of quartz crystal units with time, termed aging or long-time drift, has received much attention and accounts for a great deal of the development effort on improving stability. Great strides have been made in the past years to isolate the various physical and mechanical processes which contribute to aging of thickness shear vibrators and to develop crystal units with improved frequency stability.

Little attention has been paid, however, to wire-mounted low-frequency types. First improvements in these types were noted in measurements of width-shear vibrators. The apparent reason for improved long-time stability of this type of wire mounted crystal unit is that the support and electrical connection covers only a part of the nodal area of the plate; consequently, less dissipation and influence on frequency is produced where the supports undergo a shearing action. In other types of

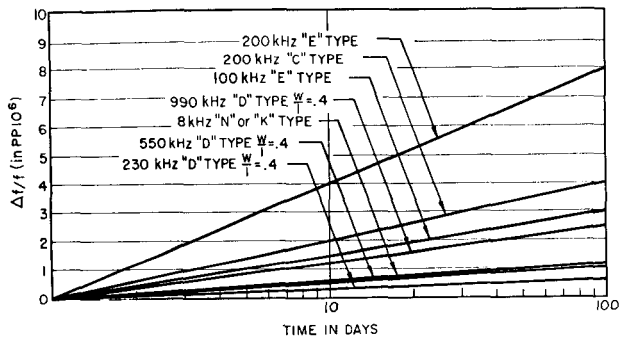

Fig. 8. Aging characteristics of low-frequency wire mounted crystal units.

extensional modes and square face shear types, the node is a point, and thus the energy lost and long-time strain relaxation at the connection is greater. This probably helps to explain why some flexure types of crystal units have low aging. The suspension system connected to the nodal points is subject to rotary motion instead of compression and extension. While none of the present low-frequency types including flexure or width-shear possess the low drift rates obtained by the high-frequency thickness shear types, it is probable that many improvements can be made by employing less dissipative and lower strain mounting systems. Figure 8 shows typical aging rates for low-frequency type crystal units produced under careful control of processes and enclosed in the cold weld holders described previously. It is apparent from these data that, of the low-frequency types, the width-shear vibrator possesses the lowest aging rate. Flexure vibrators are next, and the square face shear as well as extensional units have the highest aging rate. It is also obvious that, for a given vibrator, a lower frequency or more massive plate has a lower aging rate. Obviously, a given mounting system will have less effect, because it represents a smaller amount of the total vibrating system. The figure shows the aging of crystal units linear with logarithmic time, and this is probably true only during the first year. One would expect the rate to decrease over long periods of time.

The aging rates of high-frequency thickness shear vibrators such as the A and B types have been reduced during the past few years to exceptionally low rates, particularly those of the so-called precision type. Some general statements may be made, however, about the aging of the general-purpose, high-frequency crystal units as governed by the type of construction and the control of processes. In solder sealed metal holders, aging rates could be as high as 5 parts per million per month for the first year, and as low as 1 to 2 parts per million per year for the first two years. The high value represents lack of process control, poor design of the mounting system with high strain, and excess contamination through improper solder sealing of the enclosure. The lower value represents what can be done with good

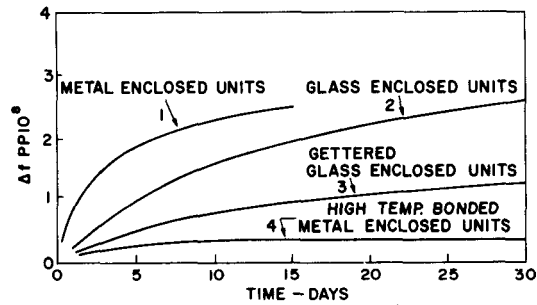

Fig. 9. Aging of metal and glass enclosed 5-MHz crystal units.

design and careful control even in solder sealed metal holders. The use of glass holders makes it necessary to use clean processes; as a material, glass is easier to clean, thus resulting in aging rates as low as and often lower than the best for metal holders. The cold welded metal holders, together with mounting systems that will allow high temperature bakeout prior to sealing, have yielded the lowest aging. Figure 9 illustrates what has been done in recent years, including the addition of getters, for a particular case [7].

According to the latest results, aging of thickness shear crystal units is caused mainly by four processes.

- 1) Temperature gradient effects lasting several minutes to several hours after a thermal disturbance.
- 2) Stress relief effects as a function of previous thermal history lasting three days to three months.
- 3) Change of mass effects caused by gain or loss of mass of the crystal plate surface, and mostly due to adsorption or desorption of gases, lasting over a period of several weeks to several years.
- 4) Structural changes in the quartz due to imperfections in the crystal lattice. These will also be long-time effects [6], [14], [42]. They may be caused by a density change due to the exit of excess vacancies to the crystal surface [43].

The frequency-time performance of precision quartz vibrators seems to be divided into two distinct parts: 1) an initial stabilization period in which there may be frequency changes as much as  $1 \text{ pp } 10^8$  for a period of three to five weeks, and 2) a much slower drift rate in which the total frequency change may be the order of 1 to  $3 \text{ pp } 10^{10}$  per month. It has been shown experimentally that the effects of adsorption and desorption of residual gas and the relaxation of temperature-induced stress may compensate one another to a certain extent [6].

Short-term frequency changes are also caused by either adsorption and desorption of gases or by strains set up between the crystal and its electrodes. Figure 10 shows the effect of a seven day oven shutoff and the effect of stopping the quartz plate vibration for 14 days [6]. From the similarity of these effects and from the fact that gettering or high temperature vacuum baking reduces these effects to a large extent, it must be con-

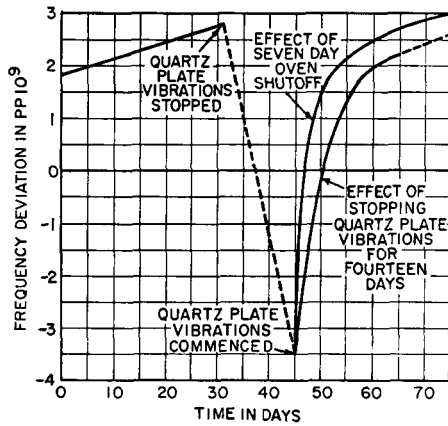

Fig. 10. Frequency change in precision quartz crystal units due to stopping quartz plate vibrations and interruption of oven control.

cluded that the frequency deviation is due to the sorption of minute quantities of gas on the crystal surface during an oven or oscillator shutdown. Figure 11 shows the effect of small abrupt temperature changes for perpendicular and for parallel field vibrators [42]. It can be seen that the transient frequency excursion due to the 1°C thermal shock is decreased by over an order of magnitude in the parallel field vibrator, the reason probably being that no strain can be set up between the active part of the crystal and the electrode, since the center of the vibrator is free of any metal plating.

Recently, a study of the effects of impurities in quartz along with an examination of the role of sorption phenomena and thermally induced strains has been initiated toward the goal of a non-aging quartz crystal, i.e., the production of a crystal unit whose frequency change with time is less than a few parts in  $10^{11}$ . Three crystal vibrators were used in a common vacuum system to differentiate thermal and mass effects [44]. Evidence of the role of impurities, particularly alkali ions, was noted. Hydrogen can be the reason for short-time instability because, in the presence of this gas, the frequency recording was broadened from 1.5 to 12 parts in  $10^{10}$ . The presence of carbon monoxide also influences frequency stability. This effect may be diminished by using the parallel field vibrator.

Short-term frequency fluctuations, however (with a sampling time of one second or less), are generally caused by the entire oscillator and will be discussed in Section IV.

### 2A.3.3. Stress, Vibration and Acceleration

Requirements exist where a crystal unit must maintain its frequency stability when vibrated and accelerated. A radio set, for instance, must operate when transported in a truck over a rough terrain. To avoid deterioration of the frequency stability by mechanical vibration, a mounting structure can be provided whose resonances are above the mechanical vibration fre-

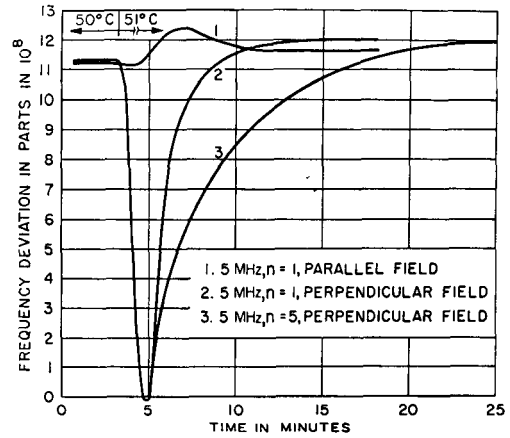

Fig. 11. Change in frequency of perpendicular and parallel field crystal vibrators due to a 1°C change in temperature.

quencies. It has been shown in the case of a 100-MHz vibrator mounted on ribbons and sealed in a TO-5 transistor cold-weld enclosure that the bandwidth measured at X-band can be reduced from 2400 Hz, as exhibited by a vibrator mounted in the standard HC-18 metal container, to 70 Hz in the case of the ribbon mounted unit [45].

Insensitivity to static acceleration is more difficult to achieve. Experiments with a centrifuge showed that it is possible to design crystal units which have a frequency acceleration coefficient of  $10^{-10}/g$  in one preferred direction. For acceleration forces applied in all directions, the frequency stability obtainable is approximately  $10^{-9}/g$  [46]. The behavior of the vibrating crystal plate under various types of external forces and stresses has been investigated experimentally and theoretically. The results are rather complicated and defy, so far, a complete theoretical explanation [47]. Specifically, it is rather difficult to separate the various stresses from one another, with the possible exception of the tensile stress. In this case, the frequency change has been proven to be always linear with the tensile force. Figure 12 gives an example chosen from many measurements [47]. It shows how the frequency change depends not only upon the amount and orientation of the force, but upon the point of attack as well. Tensile and compressional forces also change with the azimuth angle from + to - in A-type vibrators and have been used to obtain compensation of the frequency-temperature drift [48]. As far as the solution to these problems is concerned, it seems that the nonlinear theory will provide better answers than the perturbation theory [47].

### 2A.3.4. Drive Level

In a precision oscillator, another disturbing effect to be considered is the dependence of frequency upon the amplitude of vibration which, in turn, is proportional to the crystal current. Two typical curves are shown in Figure 13. Instead of amplitude or current, its square,

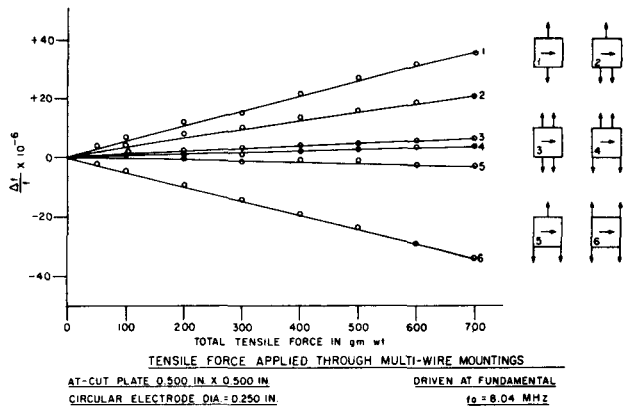

Fig. 12. Change in frequency of A-type vibrators due to external forces. The squares represent the crystal plates; the arrows in the squares indicate the direction of the X-axis, and the arrows outside indicate the applied tensile forces.

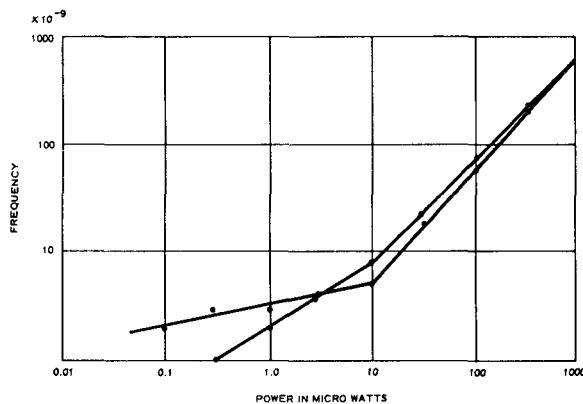

Fig. 13. Change in frequency with power dissipation in two typical 2.5-MHz crystal units.

TABLE II  
PULSED NUCLEAR RADIATION TESTS

Crystal Type	Nuclear Source	Dose		Observed Effects	
		Gamma	Fast Neutrons	Permanent Frequency Change pp 10 <sup>8</sup>	Post-Irradiation Aging 10 <sup>-8</sup> /Week
5-MHz HC-27/U Holder	Triga* Reactor	10 <sup>5</sup> R	4.6 × 10 <sup>12</sup> NVT	-7.6 to +16	-1.4 to +1.2
19-MHz, Third Overtone HC-27/U Holder	Nuclear Burst	8.5 × 10 <sup>3</sup> R	4.6 × 10 <sup>11</sup> NVT	±40 max.	-3.2 to +1.6
16-MHz, Third Overtone HC-27/U Holder	Nuclear Burst	8.6 × 10 <sup>4</sup> R	1.4 × 10 <sup>12</sup> NVT	-165 to -970	+8 to +54

\* Training, Research and Isotope Production Reactor, General Atomics.

which is proportional to the power dissipated in the crystal, is plotted as abscissa [49]. The upper portion of the curve ranging from 10 microwatts to 1 milliwatt is linear with power and has been interpreted as due to a thermal gradient between the vibrating region and the periphery of the crystal plate. A second possible explanation is a change of the stress-strain relationship in the material. Since the response time of the frequency-amplitude effect was measured to be 0.12 second, the effect seems to be related to the time required to build up the amplitude of vibration to the steady-state value and is rather short to be explained on the basis of a thermal gradient. Obviously, it is advisable to operate high precision crystal units at the lowest possible drive level. A change in crystal current (or vibrational amplitude) in 5- and 2.5-MHz fifth overtone crystal units also changes the aging behavior. An increase in current from 75 μA by one order of magnitude changes the monthly aging from 1 part in 10<sup>10</sup> to 1.5 parts in 10<sup>9</sup> [50].

### 2A.3.5. Nuclear Effects

There are applications where crystal units are exposed to a nuclear environment. The results of the in-

fluence on frequency of the exposure to steady state radiation as found in the Van Allen belt have been described in a previous review article [51]. In addition, it has been found that, when exposed to massive doses of gamma radiation, crystal units fabricated from "swept" synthetic quartz exhibit lower permanent frequency change than units made from natural quartz [52].

Table II shows the behavior of crystal units under pulsed nuclear radiation [53]. The permanent frequency change and the post-irradiation aging which occurs after the exposure to a nuclear burst are plotted together with the doses. The effects on the 16-MHz third overtone unit are quite extensive. For comparison, similar data obtained with a TRIGA reactor on a 5-MHz vibrator enclosed in the same type of holder are shown. In spite of the fact that the dose is similar to the 16-MHz experiment, the permanent frequency change and the post-irradiation aging are much lower. This is probably due to the fact that the 16-MHz unit could not be removed immediately from the nuclear environment after the actual test was over. Further studies of the effects on crystal units in a nuclear environment are required to provide statistical validity to the data obtained from previous tests.



## 2A.4. QUARTZ CRYSTAL CONTROLLED OSCILLATORS

### 2A.4.1. General Purpose Oscillators

The simplest and most general purpose oscillator is that shown in Fig. 14, where the principal control element is the quartz crystal unit. An amplifier, either vacuum tube or transistor type, is employed with some degree of selectivity dependent upon the type of crystal unit used. The degree of isolation from the load is dependent upon the output requirements and amount of stability required. In this case the main control of stability is temperature; therefore, with reasonable design, using high-frequency crystal units with A-type vibrators, one can expect a frequency stability of  $\pm 0.002$  percent over the temperature range of  $-55^{\circ}\text{C}$  to  $+105^{\circ}\text{C}$ , and  $\pm 0.0005$  percent over the restricted range of  $-20^{\circ}\text{C}$  to  $+70^{\circ}\text{C}$ . Crystal unit aging or drift is not a problem with the simple form of oscillator, since it is small compared with the change due to temperature and is easily absorbed by periodic readjustment of the circuit phase. Even though the drift rate is higher for low-frequency wire mounted units, the same reasoning can be applied because the frequency temperature characteristics are mainly parabolic and, hence, greater tolerances must be assigned over wide temperature ranges.

### 2A.4.2. Temperature Compensated Oscillator

Since temperature is the limiting factor in the stability of simple oscillators, it has been common practice to add a temperature controlling oven. Recently, there has been a trend to use temperature compensation because of the availability of stable thermistors. This principle is shown in Fig. 15. For improved stability, some measure of limiting is used as well as isolation. There are three definite advantages to temperature compensation. Little or no additional power is required, the aging rate of the crystal unit is less since it is always at the ambient temperature, and no warmup time is required. Figure 16 shows a simple compensation circuit [54]. As an example, it has been possible to reduce the frequency deviation of a 30-MHz third overtone A-type unit to 1 part in  $10^6$  for the temperature range from  $-30^{\circ}$  to  $+60^{\circ}\text{C}$ . With a more sophisticated design of the sensing network, 1 part in  $10^7$  over the temperature range  $-30^{\circ}\text{C}$  to  $+50^{\circ}\text{C}$  at 3-MHz has been reported [55]. For this high precision in compensation, no standard compensation network is possible, but computer synthesis has been proven to be feasible. Somewhat less than 1 part in  $10^6$  has been obtained by using only an inductor-capacitor-thermistor network which does not need bias voltage [56]. Figure 17 shows the frequency-temperature curve for an uncompensated and, for comparison, a compensated 25-MHz crystal unit. Other approaches to frequency compensation have been the use of temperature dependent mechanical forces on various parts of the crystal plate and a temperature dependent capacitor

[48], [54]. These two approaches would also provide a unit which could be a direct replacement for standard crystal units since no dc voltage is required. The electronic approach seems to be superior because it shows promise of increased accuracy and a wider temperature range.

### 2A.4.3. Voltage Controlled Oscillator

When it is desired to stabilize a crystal controlled oscillator to a more precise source or to link it to a voltage controlled servo, a similar circuit is used, as shown in Fig. 18. These are often referred to as VCXO (Voltage Controlled Crystal Oscillators). It is only necessary to replace the temperature sensing network with one that shifts the frequency of the crystal unit as a result of voltage changes. Stability in this case is determined by the control mechanism. A typical VCXO has a short-term stability of a few parts in  $10^9$  for one second averaging [57].

### 2A.4.4. Oscillators for Severe Environment

Stable frequency sources that are subject to high shock and vibration such as experienced in missile and space applications present a somewhat different problem. Phase coherence and spectral purity are of prime importance. Figure 19 represents this case where an oven is usually used to obtain the thermal stability required. All the component parts of these oscillators must be able to withstand the rugged environment imposed, and particular attention must be paid to the assembly. Foamed mounting is often used. The crystal unit design problem here is one of compromise. For greatest stability, the vibrator must be held in a strain-free condition, but this environment requires a moderately rigid support. The g forces are transmitted to the vibrator, resulting in a frequency shift. Also, the rigidity of the support relaxes with time, contributing to a higher aging rate. Of the various high-frequency crystal unit designs, the triple ribbon supported vibrator in the TO-5-type transistor enclosure has been found suitable for this class of service. For frequencies of 10-MHz and up, stability is in the order of 1 part in  $10^{10}$  per g if the shock and vibration frequencies are less than the mechanical resonance of the crystal vibrator mounting system. From strain relaxation considerations, the aging or drift rate will vary with frequency, being greater at the higher end. Typical examples are 1 part in  $10^{10}$  per day at 10-MHz, increasing to 1 part in  $10^8$  per day at 150-MHz. Short-term frequency instability measurements on a crystal controlled X-band source made under a vibration environment showed that the contribution due to the oscillator can be reduced to the level of other signal contaminating sources, if a ribbon-mounted cold welded crystal unit is used [45], [58].

### 2A.4.5. Precision Oscillators

If one is to obtain the greatest stability and lowest

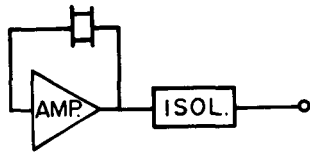

Fig. 14. General purpose crystal controlled oscillator.

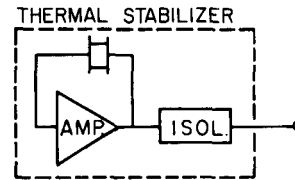

Fig. 19. Oscillator for severe mechanical and temperature environments.

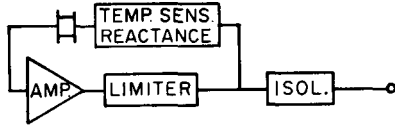

Fig. 15. Temperature compensated crystal controlled oscillator.

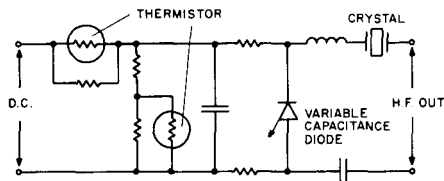

Fig. 16. Temperature compensation circuit containing one variable capacitance diode and two thermistors.

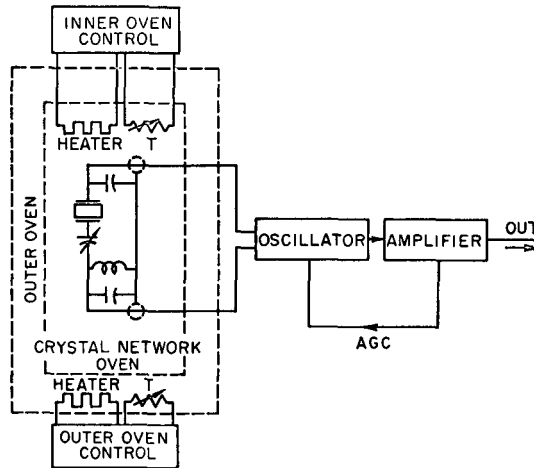

Fig. 20. Precision crystal controlled oscillator.

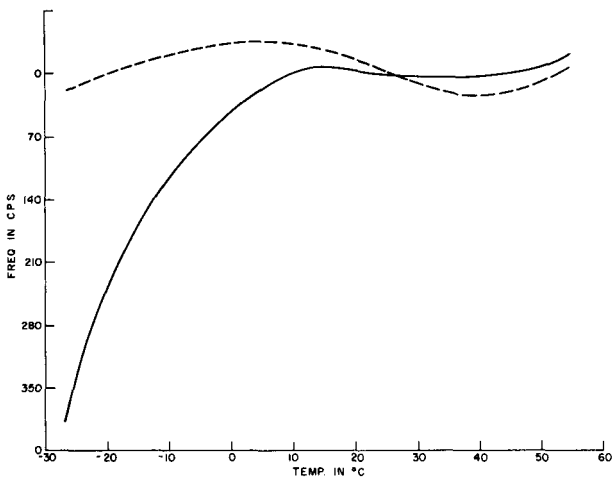

Fig. 17. Effect of compensation on the frequency of a 25-MHz crystal unit by using an inductor-capacitor-thermistor network.

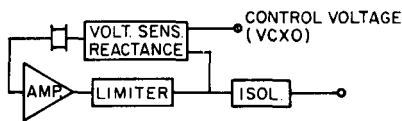

Fig. 18. Voltage controlled crystal oscillator (VCXO).

drift rate of which the best precision crystal units are capable, detailed attention must be given to the design of the oscillator circuit. Figure 20 shows the necessary controls that must be used, and is typical of most precision oscillators on the market today [2]. Not only must the temperature of the crystal unit be held constant, but also there must be no gradients in the quartz plate. Therefore, a double oven is employed and proportional control is usually used. In some cases the oscillator circuit is located within the outer oven to stabilize its component parts. As mentioned previously, one factor governing the stability of a crystal unit is that of amplitude of vibration; therefore, a large amount of negative feedback is used in the amplifier as well as A.G.C. to maintain a constant level in the oscillator circuit. Because of the advances made in temperature control and circuit development, as well as the very low coupling provided by the 2.5- and 5-MHz fifth overtone crystal unit design, the performance of these precision oscillators is determined by that of the particular crystal unit used. Presently available vacuum-tube glass-enclosed types, after a stabilization period of one to three months, show remarkably low aging or drift rates. Oscillators using the 2.5-MHz units used for stabilizing some of the Navy VLF transmitters as well as those used at the U. S. Naval Observatory have average daily drift rates as low as a few parts in  $10^{13}$  with a probable average for oscillators of this type of  $10^{-11}$  daily drift

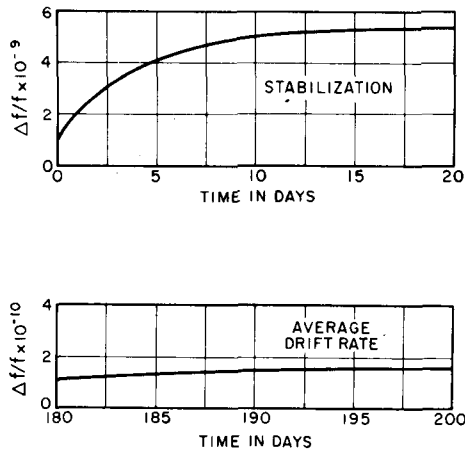

Fig. 21. Initial stabilization period and drift rate of 2.5-MHz precision oscillators.

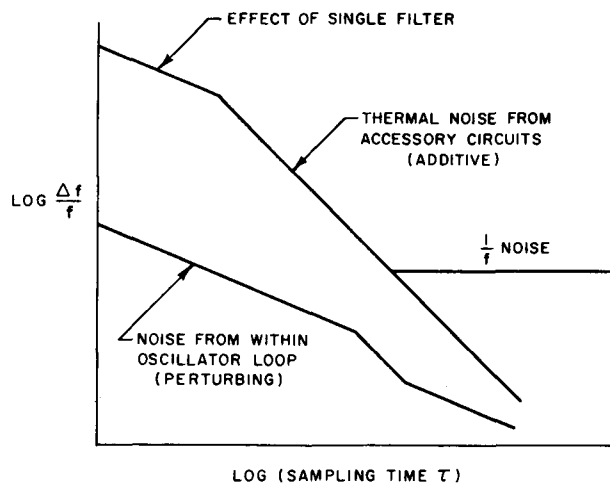

Fig. 22. Short-term stability of crystal controlled oscillators as a function of sampling period.

rate. After three weeks of operation, the aging is less than  $10^{-9}$  per week. The data are based on optimum environments and continuous operation. Typical initial stabilization and drift rate after 180 days are shown in Fig. 21. As mentioned before, after continuous operation for a period, a temporary shutdown of the oscillator or of the oven will produce a change in frequency, and a new stabilization period is again required. This effect varies with particular units, but an average change will take place as previously discussed and shown in Fig. 10. When fifth overtone  $A$  vibrators are mounted in transistor-type cold weld enclosures by thermocompression to the support ribbons, a material improvement in oscillator stability is noted, and in particular, in the oven shutdown experiment. About five hours are required for temperature stabilization, and at the end of

this period, the frequency is within less than 1 part in  $10^9$  of that before oven shutdown. Comparison with the results shown in Fig. 10 indicates the advantage of the high temperature vacuum bakeout and large thru-put capability of this design. When this type of crystal unit is employed, one to two orders of improvement may be available in precision quartz crystal controlled oscillators. Other precision crystal controlled oscillators are described in the literature [59], [60], and the influence of supply voltage changes on frequency stability is discussed [60].

#### 2A.4.6. Short-Term Stability

Practical oscillators appear to have three main sources of noise contributing to frequency fluctuations [61]–[63]:

- 1) thermal and shot noise within the oscillator itself which actually perturbs the oscillation,
- 2) additive noise associated with accessory circuits which do not perturb the oscillation, but merely add to the signal, and
- 3) fluctuations of the oscillator frequency due to either the crystal unit or circuit parameter changes.

Figure 22 shows the various calculated contributions to oscillator frequency fluctuations as a function of the sampling time  $\tau$ . As can be seen, the noise from within the oscillator varies with  $1/\sqrt{\tau}$  for low and high integration times. During the transition of the  $1/\sqrt{\tau}$  noise from a higher to a lower level, the slope changes to  $1/\tau$  during this period. The contribution of the second component varies with  $1/\tau$  and depends on the properties of an output filter. Unless the effective quality factor of this filter is very high, it is this second component which dominates the short-term frequency stability of the oscillator. The frequency fluctuations due to the last mentioned source appear to have a  $1/f$  power spectral density. The mechanism involved probably differs in various oscillators depending upon the type of crystal unit and circuitry used.

Measurements on a high precision 5-MHz crystal controlled oscillator show, in fair agreement with theory, a linear increase of stability with increase of the sampling time, namely from 2 parts in  $10^9$  for one millisecond to 3 parts in  $10^{12}$  for one second [61].

Finally, it may be stated that while the quality factor of the vibrator is most important in improving the frequency stability with respect to incidental variations in circuit parameters, the short-term stability of the oscillator is directly determined by the vibrator  $Q$  only when the additive noise components are sufficiently suppressed by narrow-band filters in the output stage.

Whereas first-order theories predict an ever increasing improvement with signal power in the signal-to-noise ratio of the oscillator output, higher order effects impose limitations, the onset of which must still be determined experimentally.

## 2A.5. CONCLUSIONS

There exists a large number of applications where the average drift rate of commercially available precision crystal units is satisfactory. With the use of atomic and molecular frequency standards or calibration by VLF, those applications requiring lower drift rates can be satisfied so that further improvements in drift characteristics of high precision crystal controlled oscillators are no longer of primary concern. The areas where these precision crystal units could be improved is in reduced initial stabilization period and obtaining reproducible drift rates. Additionally, a need exists in improving the short-term stability of crystal units and oscillators for applications such as Doppler radar, high-speed data transmission, and systems requiring phase coherence. Since many atomic and molecular standards employ crystal controlled oscillators, the short-term stability of the entire standard is dependent only upon the crystal controlled oscillator. When crystal units outside of the 2- to 10-MHz range are required, material improvements are needed to reduce the long-term drift rate, in particular, for miniaturized communication equipment in the field. In addition, more work is necessary in order to explore the influence of adverse environments such as shock, vibration, acceleration, and nuclear radiation.

## 2A.6. REFERENCES

- [1] A. W. Warner, "Design and performance of ultraprecise 2.5 Mc quartz crystal units," *Bell Sys. Tech. J.*, pp. 1193-1217, September 1960.
- [2] R. A. Sykes, W. L. Smith, and W. J. Spencer, "Performance of precision quartz-crystal controlled frequency generators," *IRE Trans. on Instrumentation*, vol. I-11, pp. 243-247, December 1962.
- [3] "IRE standards on piezoelectric crystals—the piezoelectric vibrator: definitions and methods of measurement, 1957," *Proc. IRE*, vol. 45, pp. 353-358, March 1957.
- [4] "Standards on piezoelectric crystals, 1949," *Proc. IRE*, vol. 37, pp. 1378-1395, December 1949.
- [5] D. M. Eisen, "New developments in glass enclosed crystal units," *1964 Proc. 18th Annual Symp. on Frequency Control*, pp. 204-216.
- [6] R. A. Sykes, W. L. Smith, and W. J. Spencer, "Studies on high precision resonators," *1963 Proc. 17th Annual Symp. on Frequency Control*, pp. 4-27.
- [7] R. J. Byrne and R. L. Reynolds, "Design and performance of a new series of cold welded crystal unit enclosure," *1964 Proc. 18th Annual Symp. on Frequency Control*, pp. 166-180.
- [8] W. G. Stoddart, "A new design for microminiature crystals," *ibid.*, pp. 181-191.
- [9] J. M. Stanley, "The Signal Corps synthetic quartz program," *IRE Trans. on Military Electronics*, vol. MIL-4, pp. 438-447, October 1960.
- [10] H. E. Bommel, W. P. Mason, and A. W. Warner, Jr., "Dislocations, relaxations, and anelasticity of crystal quartz," *Phys. Rev.*, vol. 102, pp. 64-71, April 1956.
- [11] W. P. Mason, "Developments in ultrasonics," *1964 Proc. 18th Annual Symp. on Frequency Control*, pp. 12-42.
- [12] J. C. King, "The anelasticity of natural and synthetic quartz at low temperatures," *Bell Sys. Tech. J.*, vol. 38, pp. 573-602, 1959.
- [13] D. B. Fraser, informal presentation at 1964 19th Annual Symp. on Frequency Control, Atlantic City, N. J.
- [14] J. M. Stevels and J. M. Volger, "Further experimental investigations on the dielectric losses of quartz crystals in relation to their imperfections," *Phillips Res. Repts.*, vol. 17, pp. 283-314, June 1962.
- [15] J. C. King, A. A. Ballman, and R. A. Laudise, "Improvement of the mechanical  $Q$  of quartz by the addition of impurities to the growth solution," *Phys. Chem. Solids*, vol. 23, pp. 1019-1025, July 1962.
- [16] J. C. King, "Dislocation and impurity induced defects in quartz," *1959 Proc. 13th Annual Symp. on Frequency Control*, pp. 1-16.
- [17] A. A. Ballman and D. W. Rudd, "The doping of cultured quartz," *1964 Proc. 18th Annual Symp. on Frequency Control*, pp. 121-128.
- [18] J. M. Stevels and J. Volger, "Impurity-induced imperfections and the dielectric properties of quartz crystals," *Phys. Chem. Glasses (GB)*, vol. 4, pp. 247-252, December 1963.
- [19] K. Hruska, "Tensor of polarizing correction terms of quartz elastic coefficients" (in Czechoslovakian), *Czech. J. Phys.*, pt. B, vol. 13, pp. 307-308, 1963.
- [20] ———, "Influence of steady polarizing electric fields on the frequency of the CT- and DT-cut piezoelectric quartz resonators" (in Czechoslovakian), *Slaboproudy Obsor (Czech.)*, vol. 25, pp. 715-717, 1964.
- [21] V. G. Zubov, M. M. Firsova, and T. M. Molokova, "Variation of dielectric constants of crystalline and fused quartz with temperature" (in Russian), *Kristallografiya (USSR)*, vol. 8, Jan.-Feb. 1963, pp. 112-114. For English translation see *Soviet Physics—Crystallography (USA)*, vol. 8, pp. 85-86, July-August 1963.
- [22] D. T. Griggs and J. D. Blacic, "Quartz: anomalous weakness of synthetic crystals," *Science*, vol. 147, pp. 292-294, January 1965.
- [23] F. Gross and F. Aussenegg, "Origin of oscillations in quartz electrolysis" (in German), *Naturwiss.*, vol. 50, p. 439, 1963.
- [24] ———, "Ion electrolysis exchange in quartz" (in German), *Acta Phys. Austriaca*, vol. 17, pp. 254-262, 1964.
- [25] D. M. Dodd and D. B. Fraser, "The 3000-3900  $\text{cm}^{-1}$  absorption bands and anelasticity in crystalline  $\alpha$ -quartz," *J. Phys. Chem. Solids*, vol. 26, pp. 673-686, April 1965.
- [26] A. Seed, "High  $Q$ , BT-type, quartz oscillator," *J. Sci. Instrum. (GB)*, vol. 41, p. 242, April 1964.
- [27] R. D. Mindlin, "Thickness-shear and flexural vibrations of crystal plates," *J. Appl. Phys.*, vol. 22, pp. 316-323, March 1951.
- [28] R. D. Mindlin and D. C. Gazis, "Strong resonances of rectangular AT-cut quartz plates," *1962 Proc. 4th U.S. Nat'l Congress Appl. Mech.*, pp. 305-310.
- [29] R. D. Mindlin and P. C. Y. Lee, "Thickness-shear and flexural vibrations of partially plated crystal plate," Dept. of Civil Engrg. and Engrg. Mechanics, Columbia University, New York, N. Y., Contract DA36-039 AMC-00065(E), Tech. Rept. 2, June 1965.
- [30] W. Shockley, D. R. Curran, and D. J. Koneval, "Energy trapping and related studies of multiple electrode filter crystals," *1963 Proc. 17th Annual Symp. on Frequency Control*, pp. 88-126.
- [31] D. R. Curran and D. J. Koneval, "Factors in the design of VHF filter crystals," *1965 19th Annual Symp. on Frequency Control*, pp. 213-286.
- [32] ———, "Energy trapping and the design of single and multi-electrode filter crystals," *1964 Proc. 18th Annual Symp. on Frequency Control*, pp. 93-119.
- [33] R. Bechmann, T. J. Lukaszek, and H. P. Wasshausen, "Improvements in HF and VHF quartz filter crystals," *Proc. IEEE*, vol. 53, pp. 1160-1161, August 1965.
- [34] G. Sauerbrey, "Messung von Plattenschwingungen sehr kleiner Amplitude durch Lichtstrommodulation," *Z. Phys.*, vol. 178, pp. 457-471, April 1964.
- [35] I. Koga, "Radio-frequency vibration of rectangular AT-cut quartz plates," *J. Appl. Phys.*, vol. 34, pp. 2357-2365, August 1963.
- [36] A. J. DeMaria and G. Barnard, "Visual observations of piezoelectric modes," *J. Appl. Phys.*, vol. 34, pp. 2296-2297, August 1963.
- [37] M. Onoe, "Analysis and detection of unwanted modes in quartz crystal units for oscillators," *J. Inst. Elec. Commun. Engrs. (Japan)*, vol. 47, pp. 38-47, January 1964.
- [38] W. J. Spencer, "Modes in circular AT-cut quartz plates," *IEEE Trans. on Sonics and Ultrasonics*, vol. SU-12, pp. 1-5, March 1965.
- [39] R. A. Young, R. B. Belsler, A. L. Bennett, W. H. Hicklin, J. C. Meaders, and C. E. Wagner, "Special X-ray studies of quartz frequency control units," *1965 Proc. 19th Annual Symp. on Frequency Control*, pp. 23-41.
- [40] R. Bechmann, "Excitation of piezoelectric plates by use of a parallel field with particular reference to thickness modes of quartz," *Proc. IRE*, vol. 48, pp. 1278-1280, July 1960.
- [41] W. Janouchesky, "High  $Q$  crystal units," *1963 Proc. 17th Annual Symp. on Frequency Control*, pp. 233-247.
- [42] A. W. Warner, "Use of parallel-field excitation in the design of quartz crystal units," *ibid.*, pp. 248-266.
- [43] O. Sh. Grois, "One possible mechanism of quartz aging," *Radiotekhnika i Elektronika (USSR)*, vol. 7, pp. 702-705, April 1962. For English translation, see *Radio Engrg., Electronic Phys.*, vol. 7, p. 651, April 1963.
- [44] A. W. Warner, D. B. Fraser, and C. D. Stockbridge, "Funda-

- mental studies of aging in quartz resonators," *IEEE Trans. on Sonics and Ultrasonics*, vol. SU-12, pp. 52-59, June 1965.
- [45] D. B. Leeson, "Aerospace crystal environmental requirements," *1965 Proc. 19th Annual Symp. on Frequency Control*, pp. 49-58.
- [46] W. J. Spencer and W. L. Smith, "Precision crystal frequency standards," *1961 Proc. 15th Annual Symp. on Frequency Control*, pp. 139-155.
- [47] C. R. Miggins, L. C. Barcus, and R. W. Perry, "Effects of external forces on vibrating crystal plates," Lowell Technological Inst. Research Foundation, Contract DA36-039 AMC-02239(E), Final Rept., May 1, 1963 to April 30, 1965.
- [48] E. A. Gerber and M. H. Miles, "Reduction of the frequency-temperature shift of piezoelectric resonators by mechanical stress," *Proc. IRE*, vol. 49, pp. 1650-1654, November 1961.
- [49] D. L. Hammond, C. Adams, and L. Cutler, "Precision crystal units," *1963 Proc. 17th Annual Symp. on Frequency Control*, pp. 215-232.
- [50] A. Karolus and D. Aus Dem Bruch, "On the aging of harmonic quartz crystals of 2 and 2.5 Mc/s" (in German), *Z. Instrumentenkunde*, vol. 72, pp. 229-232, August 1964.
- [51] R. B. Belser and W. H. Hicklin, "Aging characteristics of quartz resonators with comments on the effect of radiation," *1963 Proc. 17th Annual Symp. on Frequency Control*, pp. 127-175.
- [52] G. K. Guttwein, "Quartz crystals and quartz oscillators," *1964 Proc. Internat'l Conf. on Chronometry*, pp. 30-51.
- [53] J. M. Stanley, "Effects of transient radiation on frequency control devices," in *Transient Radiation Effects on Electronics*. Battelle Memorial Inst. Handbook, 1965, pp. L-1 to L-11.
- [54] D. E. Newell, H. Hinnah, and R. Bangert, "Advances in crystal oscillator and resonator compensation," *1964 Proc. 18th Annual Symp. on Frequency Control*, pp. 487-534.
- [55] R. Bangert, H. Hinnah, and D. E. Newell, "Recent developments in crystal oscillator temperature compensation," *1965 Proc. 19th Annual Symp. on Frequency Control*, pp. 617-641.
- [56] S. B. Boor, W. H. Horton, and R. B. Angove, "Passive temperature compensation of quartz crystals for oscillator applications," *ibid.*, pp. 105-124.
- [57] R. L. Kent, "The voltage-controlled crystal oscillator (VCXO), its capabilities and limitations," *ibid.*, pp. 642-654.
- [58] J. R. Buck and D. J. Healey, "Short term frequency stability measurement of crystal controlled X-band source," *1964 Interim Proc. Symp. on Definition and Measurement of Short-Term Frequency Stability*, pp. 111-91 to 111-120.
- [59] E. V. Dvornikov, E. A. Mavrin, and N. V. Morkovin, "A high-stability transistorized crystal oscillator," *Pribery i Tekhn. Eksperim. (USSR)*, no. 4, July-August 1963. For English translation see *Instr. Exper. Tech. (USSR)*, pp. 672-674, July-August 1963.
- [60] P. J. Baxandall, "Transistor crystal oscillators and the design of a 1-mc/s oscillator circuit capable of good frequency stability," *Radio Electronic Engrg. (GB)*, vol. 29, pp. 229-246, April 1965.
- [61] L. S. Cutler, "Some aspects of the theory and measurement of frequency fluctuations in frequency standards," *1964 Interim Proc. Symp. on Definition and Measurement of Short-Term Frequency Stability*, pp. 11-73 to 11-104.
- [62] E. Hafner, "The effects of noise on crystal oscillators," *ibid.*, pp. 11-157 to 11-204.
- [63] W. A. Edson, "Progress and problems in short term stability," *1965 Proc. 19th Annual Symp. on Frequency Control*, pp. 43-48.

Reprinted from the PROCEEDINGS OF THE IEEE

VOL. 54, NO. 2, FEBRUARY, 1966

Pp. 103-116

Copyright 1966, and reprinted by permission of the copyright owner  
PRINTED IN THE U.S.A.

Manuscript received November 15, 1965; revised November 29, 1965.

NBS Editors Note: The symbol,  $f$ , used in Chapter 2A (figs. 7, 8, 9, 12, 21, and 22) is equivalent to,  $\nu$ , shown in the glossary of Chapter 8; thus:

$$\Delta f \equiv \delta\nu; \frac{\Delta f}{f} \equiv y \equiv \frac{\delta\nu}{\nu_0}$$

where  $\nu_0$  is the nominal frequency.

## CHAPTER 2—PART B

### PROGRESS IN THE DEVELOPMENT OF QUARTZ CRYSTAL UNITS AND OSCILLATORS SINCE 1966\*

Eduard A. Gerber† and Roger A. Sykes‡

#### Contents

	Page
2B.1. Introduction.....	59
2B.2. Quartz Crystal Units.....	59
2B.2.1. Equivalent Circuit.....	59
2B.2.2. Vibrator Types.....	59
2B.2.3. Quartz Material.....	59
2B.2.4. Modes of Motion.....	59
2B.3. Frequency Stability as a Function of:	
2B.3.1. Temperature.....	60
2B.3.2. Time (Aging).....	61
2B.3.3. Stress, Vibration and Acceleration.....	61
2B.3.4. Drive Level.....	61
2B.4. Quartz Crystal Controlled Oscillators.....	62
2B.4.1. Short-Term Stability.....	62
2B.5. Conclusions and Possible Future Developments.....	62
2B.6. References.....	63

\* Manuscript received October 9, 1972.

† Electronics Technology and Devices Laboratory, U.S. Army Electronics Command, Ft. Monmouth, NJ 07703.

‡ Formerly with Bell Telephone Laboratories, Allentown, PA 18103.

"And step by step, since time began, I see the steady gain of man."  
Whittier, *The Chapel of the Hermits*.

This chapter highlights progress in the field of quartz crystal units and oscillators since publication of similar material in 1966 (see chap. 2A). The organization of the chapter follows Part A. Specific subjects described include: (1) Quartz crystal units — equivalent circuits, vibrator types, quartz material, and modes of motion. (2) Frequency stability in terms of temperature, aging, stress, vibration, acceleration, and drive level. A small fundamental-mode crystal unit has been designed in the range of 15–23 MHz which can survive shock acceleration of 15,000 g's or more. (3) Short-term stability of crystal oscillators is discussed with reference to aspects of noise and fluctuations of various types of precision oscillators. The chapter ends with a view towards future developments and technical possibilities in the field of crystal oscillators.

**Key words:** Crystal aging; crystal characteristics; crystal oscillators; frequency stability; quartz crystals; quartz material; precision frequency sources; short-term stability.

## 2B.1. INTRODUCTION

Part B discusses progress in the state of the art of quartz crystal units and oscillators since 1966. It includes subjects covered earlier in similar papers [1, 2]<sup>1</sup> and follows the format of Part A.

## 2B.2. QUARTZ CRYSTAL UNITS

In this section we consider a general equivalent circuit, vibrator types, quartz material, and modes of motion recently evaluated in quartz crystal units.

### 2B.2.1. Equivalent Circuit

A more general equivalent circuit has been derived [3] that is valid at any frequency up to and including the lower UHF ranges but reduces to the conventional circuit (fig. 1 in chap. 2A) if the parameters are properly redefined. The characteristics are illustrated with the aid of crystal impedance and admittance diagrams. Recently, the equivalent circuit has been further expanded by using transmission lines in addition to lumped elements. It can thus represent a stack of thickness mode crystal vibrators [4].

### 2B.2.2. Vibrator Types

Lately, more effort has gone into bridging the gap between face shear and thickness shear vibrators. A width-shear quartz resonator has been developed for applications between 0.8 and 3 MHz [5]. It has an unusually high length-to-width ratio of 25 and is symmetrically bevelled on one of its major edges.

### 2B.2.3. Quartz Material

The anelastic effects of sodium, lithium, and potassium impurities have been studied from liquid helium temperatures to near the quartz inversion point at 573 °C [6]. Recent work has shown that the major source of acoustic loss in the normal operating temperature range is due to the hydrogen bonded OH content in the crystal. It also was shown that this H-bonded OH-content causes characteristic absorption of light in the near-infrared region, affording a rapid evaluation of the OH content and hence of Q in newly grown material [7]. Specific curves are given for the sodium hydroxide and sodium carbonate growth process which relate the extinction coefficient at 3500 cm<sup>-1</sup> with the Q measured on 5 MHz (5th overtone) high precision resonators [8, 9]. It should be noted that the absorption measurement method must be made in an exact and precise manner for Q's in excess of 1 million.

The Na<sub>2</sub>CO<sub>3</sub> method leads to crystals of small hydrogen content and yields Q values in the order of 2 to 3 million at 5 MHz [10]. The more rapid growth in the NaOH process initially led to Q values much below one million, but Q in the order of one to two million may be obtained by using additives in the solution [11]. Correlation between the density of dislocations, the distortion of the crystal structure, and the half-width of X-ray diffraction was established with the Q-value obtained through the infrared absorption method [12].

### 2B.2.4. Modes of Motion

Progress has continued in determining motion types in plates as well as improving mathematical analysis of the complex phenomena in specific resonators. Figure 2B.1 compares theoretical and experimental results of flexure and shear modes in high frequency crystal resonators, including those due to a twist in the third dimension. It illustrates the progress that has been made in identifying and describing the more complex forms of the thickness shear and flexure modes [13]. The various modes are shown in figure 2B.2 [13]. As can be seen, the mode shape comprises phase reversals across the width of the plate which result in a twisting deformation across the width. Recently, the thickness-shear and shear-flexure-twist vibrations in rectangular AT-cut plates with partial electrodes have been analyzed; the results were compared with x-ray topographs [14, 15]. At the lower end of the vibrational spectrum of quartz plates, closed

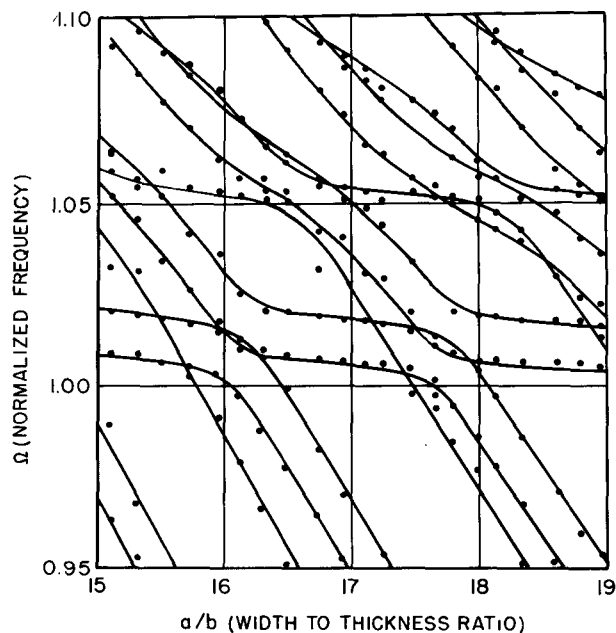

Fig. 2B.1. Computed and measured resonance for rectangular AT-cut quartz plates with a length to thickness ratio of 20.

<sup>1</sup> Figures in brackets indicate literature references at the end of this chapter.



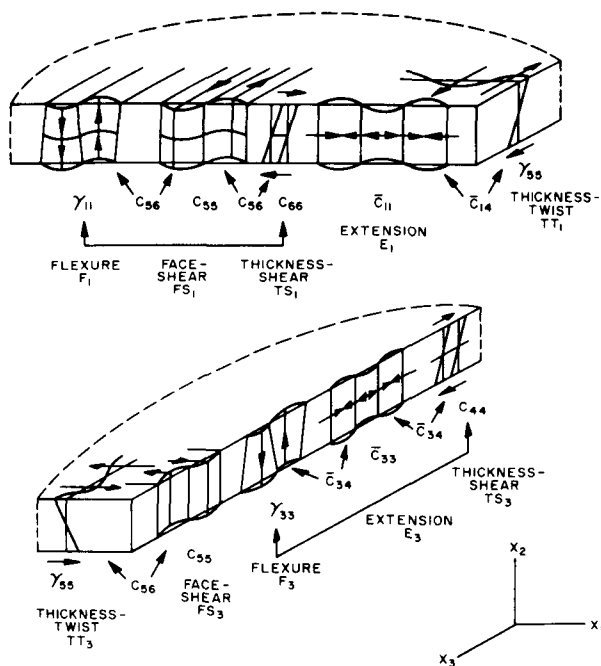

Fig. 2B.2. Mode shapes in quartz plates.

form solutions of coupled extensional, flexural, and width-shear vibrations have been obtained for thin rectangular plates with free edges. These solutions check very well with experimental results [16].

The theory of crystalline body vibration, developed at Columbia University and elsewhere, formed the basis for hypothesizing the phenomenon of "energy trapping" [17, 18]. The dispersion curve for thickness shear and flexural waves in an infinite plate, propagated in the X-direction, is shown in figure 2B.3; this demonstrates the criticality of the electrode dimensions. Dimensionless frequency is plotted as ordinate and lateral wave number as abscissa. The upper curves are the dispersion curves for the uncoated and the lower ones for the coated part of the plate. The amount of frequency decrease is dependent upon the piezoelectric coupling in addition to the mass of the electrode. To the left of zero, the wave number is imaginary, and the waves are non-propagating. At frequencies between the two cut-off frequencies, the thickness-shear motion in the plated part is propagating; in the unplated portion, however, there is non-propagation so that the amplitude decreases exponentially outside of the plated portion. Above the cut-off frequency of the unplated portion both waves are propagating over the entire plate. If the x-dimension of the plating is short enough, the lateral wavelength of the first anharmonic overtone would

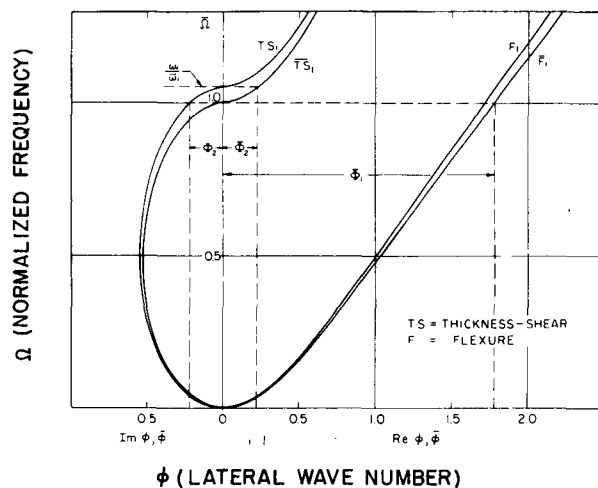

Fig. 2B.3. Dispersion curves for thickness shear and flexure in a quartz plate; the upper curves are the dispersion curves for the uncoated and the lower ones for the coated part of the plate.

have to be  $\sim 2/3$  the length of the plating; the wave number then would be high, and the frequency of the anharmonic overtone would be above the cut-off frequency in the unplated portion. This would result in the first and all higher overtones propagating out. Thus, the critical length of plating for a given thickness will be inversely proportional to the wave number in the plated portion at the cut-off frequency of the unplated portion of the plate. The reader is referred to the literature [13, 19] for detailed study of electrode dimension relations for trapped energy resonators.

Studies have continued on strain or displacement in vibrating crystal plates through x-ray topographic methods. This technique shows both imperfections in the material (which result in lattice distortions) [20] and strain from the thin metal films on quartz [21, 22].

## 2B.3. FREQUENCY STABILITY AS A FUNCTION OF:

### 2B.3.1. Temperature

The development of a new type of double-rotated crystal plate, the FC-cut, may prove to be a superior alternative to the AT-type in many applications; examples are 1) oven controlled units at elevated temperature, 2) temperature compensated oscillators at discreet temperature ranges, and 3) fast warm-up applications [23]. The "flatness" of the turning point of an FC-cut at 80 °C is equivalent to the "flatness" of the turning point of an AT-cut in the region of 40 °C (see fig. 7 in chap. 2A).

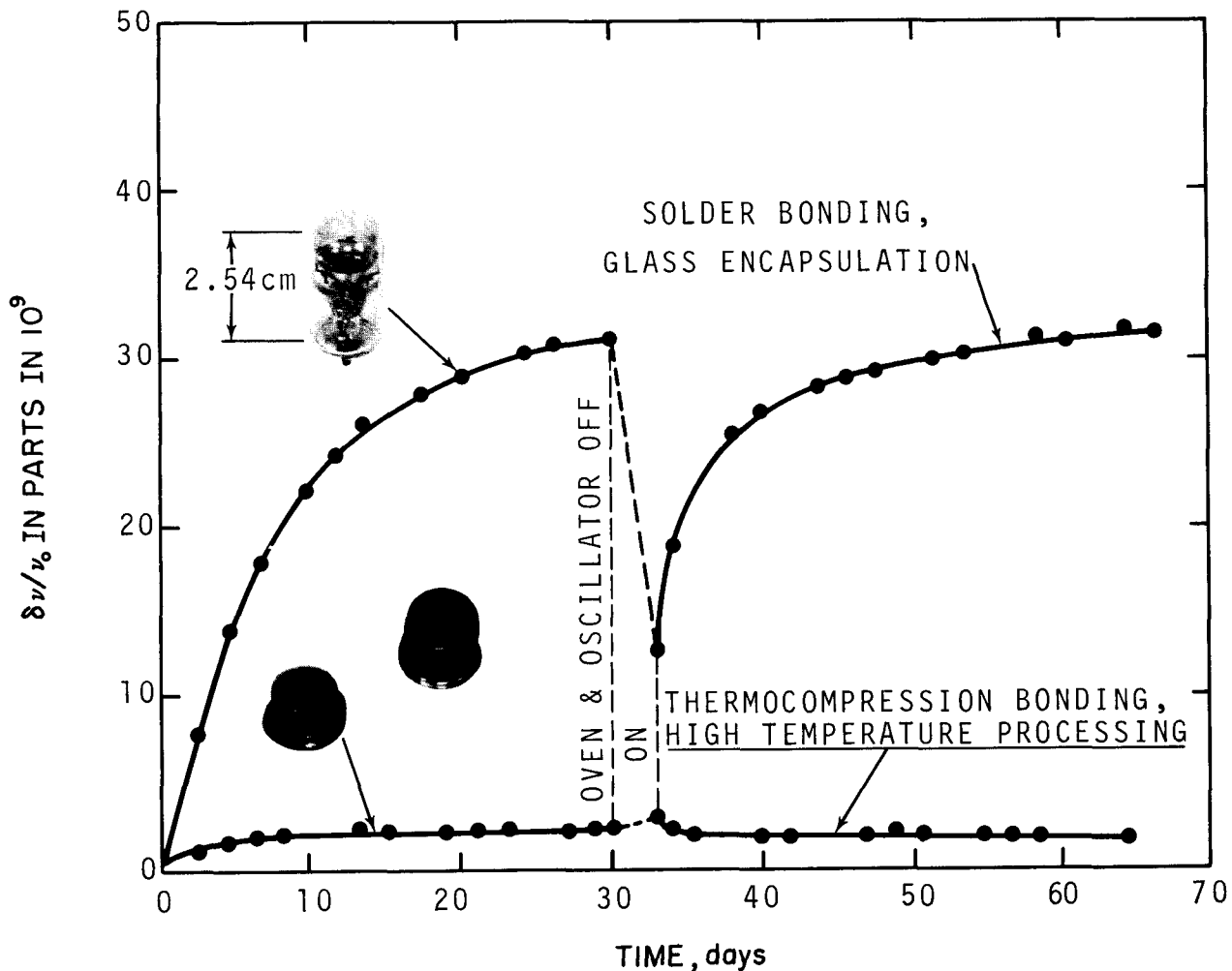

Fig. 2B.4. Frequency change in precision quartz crystal units from stopping quartz plate vibrations and interrupting oven control.

### 2B.3.2. Time (Aging)

Short-term frequency changes can be caused by either adsorption and desorption of gases or by strains set up between the crystal plate and its electrodes [24]. Figure 2B.4 shows the effect of shutting off the oven and stopping the quartz plate vibration for three days. As can be seen, the recovery from temperature control or power supply interruptions can be greatly improved by using both a mounting system for the quartz plate (that may be vacuum-baked) and cold-welded metal enclosures. The mounting system that supports the quartz vibrator in the metal enclosure makes use of higher temperature bonding alloys than for the glass units; thus, the complete unit may be high-temperature, vacuum-baked in an oil-free system and then cold-welded while under vacuum. This results in less contamination and strain in the mounting, with a consequent shortening of the initial stabilization time.

### 2B.3.3. Stress, Vibration and Acceleration

Progress has been made in designing small fundamental-mode crystal units, in the frequency range of 15 to 23 MHz, which will survive shock acceleration amplitudes of 15,000 g's and more. The quartz resonator is bonded to the support, using electroplated nickel films of thicknesses about  $10\ \mu\text{m}$  [25].

### 2B.3.4. Drive Level

It has been known for some time that the resonance resistance in some At-cut quartz units increased considerably for very low drive levels. This large crystal-unit resistance can prevent initial oscillations. It has been found that small metal particles, sticking on active quartz surfaces, cause the current dependency of the resistance, and other constants as well [26].

## 2B.4. QUARTZ CRYSTAL CONTROLLED OSCILLATORS

A major advance in quartz crystal controlled oscillators has been short-term stability; this is described in the following section.

### 2B.4.1. Short-Term Stability

The importance of the problem of short-term frequency stability is evidenced by the large number of papers devoted to the subject. It can be touched on only very briefly within the framework of this review. Figure 2B.5 shows the phase noise of a 5-MHz precision oscillator (referred to a 1-Hz bandwidth) within the frequency range of 100 Hz to 5 kHz [27]. It should be noted that the noise is approximately 8 dB lower for a field effect transistor (2N3823) than for a silicon planar transistor (2N2222) used in the oscillator and amplifier stages. Phase noise under vibration is somewhat higher than in the quiescent state.

A state-of-the-art advance of more than 10 decibels was reported recently for 5-MHz quartz oscillators [28]. This was achieved by selection of transistors for the lowest possible flicker of phase and DC flicker noise, and by utilizing massive negative feedback. Similar results are reported in [29]. A more general review of the fundamentals and aspects of noise and fluctuation on signals, which lead to characteristics of various types of precision signal sources, can be found in reference [30]. Reference should also be made to the *IEEE-NASA Symposium on Short-Term Frequency Stability* [31] and to the special issue of the *Proceedings of the IEEE on Frequency Stability* [32].

Finally, an overview of the state-of-the-art in short-term stability of high precision frequency sources, as it existed at the time of this report, is

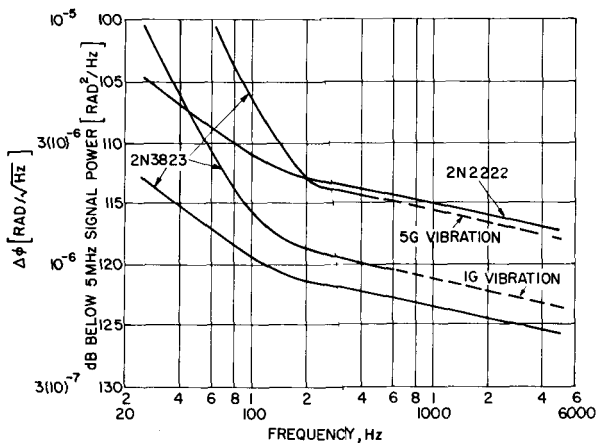

Fig. 2B.5. Oscillator output phase noise referred to 1-Hz band.

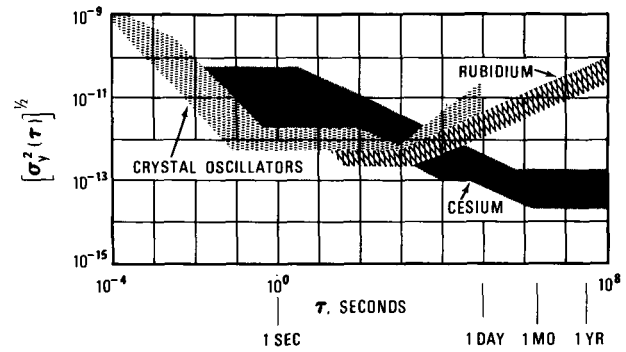

Fig. 2B.6. Stability values of frequency standards, indicating the margin between specified data and performance of selected units.

given in figure 2B.6 [33]. In each case, some spread in the data has been allowed for. The better values correspond to measurements on selected units, whereas the more-conservative limit corresponds to data specified in manufacturers' data sheets.

## 2B.5. CONCLUSIONS AND POSSIBLE FUTURE DEVELOPMENTS

During the past 6 years, the technical possibilities and future trends have become more evident. For communications, we have analog and digital systems, both of which are dependent upon an accurate frequency source. In the digital case, we need a clock which in many cases must be regenerated or phase locked with a transmitting or central clock. In analog systems, in addition to the frequency generator or clock, we need a precise filter to select one channel from another. With the present progress in integrated circuitry, frequencies can be generated very simply and synthesized to place them anywhere as needed in the frequency spectrum. All that is required is one precise generator. Very probably there will be fewer crystal units produced for these systems, but they will have higher accuracy. There should be a material size reduction in the higher frequency units. Present 10 MHz crystal units can be produced with crystal plates 7.5 mm in diameter or less. At 30 MHz they should be 2.5 mm or less. It is inconceivable that any of these plates would be put in present holders. They probably will be in the form of thin enclosures not over 30-50 mils thick and will have beam leads. It is believed that if we take a look at the progress that has been made in integrated circuit technology and apply some of those techniques to the present crystal design and developments, we would be far ahead. For example, batch processing becomes feasible for smaller size plates and,

except for final adjustment, 100 vibrators can be processed from a 1-in (2.54 cm) square plate. There should be standardization of generator frequencies to make them off-the-shelf items for applications to digital and analogue, wire, and radio transmission systems. In the future there will be more and more use of mobile and marine radio equipment. With developments in active solid state devices moving in the direction of performing functions, it is inconceivable that elements for frequency control and selection would not follow this same trend. Some solid state designs have already started, but presently available VCXO's (voltage controlled crystal oscillators) and filters resemble little the advancements in integrated circuitry. What is envisioned is a completely integrated series of functions utilizing crystal resonators to produce frequency generators, synthesizers, translators and modulators; narrow band amplifiers for SSB, AM and FM systems; and discriminators for FM systems. These functional devices should be compatible with other equipment components in both size and performance to form integral parts of a system.

## 2B.6. REFERENCES

- [1] Gerber, E. A., and Sykes, R. A., "Quartz frequency standards," *Proc. IEEE*, **55**, No. 6, pp. 783-791 (June 1967).
- [2] Gerber, E. A., and Sykes, R. A., "Quarter century of progress in the theory and development of crystals for frequency control and selection," *Proc. 25th Ann. Symp. on Frequency Control* (U.S. Army Electronics Command, Ft. Monmouth, NJ 07703, April 26-28, 1971), pp. 1-45 (NTIS, AD 746211, 1971).
- [3] Hafner, E., "The piezoelectric crystal unit—definitions and methods of measurement," *Proc. IEEE*, **57**, No. 2, pp. 179-201 (February 1969).
- [4] Ballato, A., "Transmission-line analogs for stacked piezoelectric crystal devices," *Proc. 26th Ann. Symp. on Frequency Control* (U.S. Army Electronics Command, Ft. Monmouth, NJ 07703, June 6-8, 1972), pp. 86-91 (Electron. Ind. Assn., Washington, DC 20006, 1972).
- [5] Royer, J. J., "A new DT quartz resonator," *IEEE Trans. on Sonics and Ultrasonics*, **SU-17**, No. 1, pp. 18-22 (January 1970).
- [6] Fraser, D. B., "Anelastic effects of alkali ions in crystalline quartz," *J. Appl. Phys.*, **35**, No. 10, pp. 2913-2918 (October 1964).
- [7] Byrne, R. J., and Reynolds, R. L., "Design and performance of a new series of cold welded crystal unit enclosure," *Proc. 18th Ann. Symp. on Frequency Control* (U.S. Army Electronics Labs., Ft. Monmouth, NJ 07703, May 4-6, 1964), pp. 166-180 (NTIS, AD 450 341, 1964).
- [8] Fraser, D. B., Dodd, D. M., Rudd, D. W., and Carroll, W. J., "Using infrared to find the mechanical Q of  $\alpha$ -quartz," *Frequency*, **4**, No. 1, pp. 18-21 (January-February 1966).
- [9] Sawyer, B., "Q capability indications from infrared absorption measurements for  $\text{Na}_2\text{CO}_3$  process cultured quartz," *IEEE Trans. on Sonics and Ultrasonics*, **SU-19**, No. 1, pp. 41-44 (January 1972).
- [10] Sawyer, B., "Pilot plant production of cultured quartz," Sawyer Research Products, Inc., Eastlake, Ohio, *Final Report Contract DA 36-039-sc-81245* (January 1964).
- [11] Ballman, A. A., Laudise, R. A., and Rudd, S. W., "Synthetic quartz with a mechanical Q equivalent to natural quartz," *Appl. Phys. Lett.*, **8**, No. 2, pp. 53-54 (January 1966).
- [12] Asahara, J., and Taki, S., "Physical properties of synthetic quartz and its electrical characteristics," *Proc. 26th Ann. Symp. on Frequency Control* (U.S. Army Electronics Command, Ft. Monmouth, NJ 07703, June 6-8, 1972), pp. 93-96 (Electron. Ind. Assn., Washington, DC 20006, 1972).
- [13] Mindlin, R. D., and Spencer, W. J., "Anharmonic, thickness-twist overtones of thickness-shear and flexural vibrations of rectangular, AT-cut quartz plates," *J. Acoustical Soc. Am.*, **42**, No. 6, pp. 1268-1277 (December 1967).
- [14] Byrne, R. J., Lloyd, P., and Spencer, W. J., "Thickness-shear vibration in rectangular AT-cut quartz plates with partial electrodes," *J. Acoustical Soc. Am.*, **43**, No. 2, pp. 232-238 (February 1968).
- [15] Lee, P. C. Y., and Spencer, W. J., "Shear-flexure-twist vibrations in rectangular AT-cut quartz plates with partial electrodes" *J. Acoustical Soc. Am.*, **45**, No. 3, pp. 637-645 (March 1969).
- [16] Lee, P. C. Y., "Extensional, flexural, and width-shear vibrations of thin rectangular crystal plates," *Proc. 25th Ann. Symp. on Frequency Control* (U.S. Army Electronics Command, Ft. Monmouth, NJ 07703, April 26-28, 1971), pp. 63-69 (NTIS, AD 746211, 1971).
- [17] Mortley, W. S., "Energy trapping," *Marconi Review*, **30**, No. 165, pp. 53-67 (Second Quarter 1967).
- [18] Shockley, W., Curran, D. R., and Koneval, D. J., "Trapped-energy modes in quartz filter crystals," *J. Acoustical Soc. Am.*, **41**, No. 4 (Part 2), pp. 981-993 (April 1967).
- [19] Mindlin, R. D., "Studies in the mathematical theory of vibrations of crystal plates," *Proc. 20th Ann. Symp. on Frequency Control* (U.S. Army Electronics Command, Ft. Monmouth, NJ 07703, April 19-21, 1966), pp. 252-265 (NTIS, AD 800 523, 1966).
- [20] Spencer, W. J., and Haruta, K., "Defects in synthetic quartz," *J. Appl. Phys.*, **37**, No. 2, pp. 549-553 (February 1966).
- [21] Haruta, K., and Spencer, W. J., "Strain in thin metal films on quartz," *J. Appl. Phys.*, **37**, No. 6, pp. 2232-2233 (May 1966).
- [22] Haruta, K., and Spencer, W. J., "X-ray diffraction studies of vibrational modes," *Proc. 20th Ann. Symp. on Frequency Control* (U.S. Army Electronics Command, Ft. Monmouth, NJ 07703, April 19-21, 1966), pp. 1-13 (NTIS, AD 800 523, 1966).
- [23] Lagasse, G., Ho, J., and Block, M., "Research and development of a new type of crystal—the FC-cut," *Proc. 26th Ann. Symp. on Frequency Control* (U.S. Army Electronics Command, Ft. Monmouth, NJ 07703, June 6-8, 1972), pp. 148-151 (Electron. Ind. Assn., Washington, DC 20006, 1972).
- [24] Armstrong, J. H., Blomster, P. R., and Hokanson, J. L., "Aging characteristics of quartz crystal resonators," *Proc. 20th Ann. Symp. on Frequency Control* (U.S. Army Electronics Command, Ft. Monmouth, NJ 07703, April 19-21, 1966), pp. 192-207 (NTIS, AD 800 523, 1966).
- [25] Bernstein, M., "Quartz crystal units for high G environment," *Proc. 25th Ann. Symp. on Frequency Control* (U.S. Army Electronics Command, Ft. Monmouth, NJ 07703, April 26-28, 1971), pp. 125-133 (NTIS, AD 746211, 1971).
- [26] Nonaka, S., Yuuki, T., and Hara, K., "The current dependency of crystal unit resistance at low drive level," *Proc. 25th Ann. Symp. on Frequency Control* (U.S. Army Electronics Command, Ft. Monmouth, NJ 07703, April 26-28, 1971), pp. 139-147 (NTIS, AD 746211, 1971).
- [27] Pustarfi, H. S., "An improved 5 MHz reference oscillator for time and frequency standard applications," *IEEE Trans. Instrum. and Meas.*, **IM-15**, No. 4, pp. 196-202 (December 1966).
- [28] Brandenberger, H., Hadom, F., Halford, D., and Shoaf, J. H., "High quality quartz crystal oscillators: frequency domain and time domain stability," *Proc. 25th Ann. Symp. on Frequency Control* (U.S. Army Electronics Command, Ft. Monmouth, NJ 07703, April 26-28, 1971), pp. 206-230 (NTIS, AD 746211, 1971).
- [29] Driscoll, M. M., "Two-stage self-limiting series mode type quartz crystal oscillator exhibiting improved short-term frequency stability," *Proc. 26th Ann. Symp. on Frequency*

- Control* (U.S. Army Electronics Command, Ft. Monmouth, NJ 07703, June 6-8, 1972), pp. 43-49 (Electron. Ind. Assn., Washington, DC 20006, 1972).
- [30] Cutler, L. S., "Stability characteristics and application techniques for precision frequency sources," *Proc. 3rd Ann. DOD Precise Time and Time Interval (PTTI) Strategic Plan, Meet.* (U.S. Naval Observatory, Washington, DC 20390, November 16-18, 1971), pp. 229-253 (USNO, Washington, DC 20390, 1972). (NTIS, AD 758 739)
- [31] Chi, A. (Chairman), *Proc. IEEE-NASA Symp. on Short-Term Frequency Stability* (Goddard Space Flight Center, Greenbelt, Md 20771, November 23-24, 1964), NASA Report SP-80, 317 pages (USGPO, 1965).
- [32] Chi, A. (Editor), Special Issue on Frequency Stability, *Proc. IEEE*, **54**, No. 2 (February 1966).
- [33] Kartaschoff, P., and Barnes, J. A., "Standard time and frequency generation," *Proc. IEEE*, **60**, No. 5, pp. 493-501 (May 1972).

# CHAPTER 3

## THE PHYSICAL BASIS OF ATOMIC FREQUENCY STANDARDS\*

Allan S. Risley†

### Contents

	Page
3.1. Introduction.....	67
3.2. Atomic Energy Levels.....	67
3.2.1. Four Basic Ideas.....	67
a. The Electron.....	67
b. The Nucleus.....	67
c. The Quantization of the Energy of Atoms.....	68
d. The Quantization of the Electromagnetic Field.....	68
3.2.2. The Bohr Model of the Hydrogen Atom.....	68
3.2.3. Quantum Mechanics.....	70
3.2.4. Spin—Additional Energy Levels.....	70
3.3. The Interaction Between Atoms and Electromagnetic Radiation.....	71
3.3.1. Maxwell's Theory of Electromagnetic Radiation.....	71
3.3.2. The Dependence of Atomic Transitions upon EM Radiation.....	71
3.3.3. Transition Probability and Linewidth of Actual Frequency Standards.....	72
3.4. Choosing a Suitable Atom.....	73
3.4.1. The Energy Levels of a Many-Electron Atom.....	73
3.4.2. The Hyperfine Interaction.....	76
3.4.3. Criteria for Choosing an Atom.....	77
3.4.4. The Need for State Selection.....	78
3.5. The Three Major Examples of Atomic Frequency Standards.....	78
3.5.1. General Considerations.....	78
a. Common Functions.....	78
b. Primary versus Secondary Standards.....	78
3.5.2. The Hydrogen Maser.....	79
3.5.3. The Cesium Beam.....	80
3.5.4. The Rubidium Gas Cell.....	81
3.6. Summary.....	83
3.7. References.....	84
3.8. Bibliography.....	84

\*Published as Nat. Bur. Stand. (U.S.) Tech. Note 399, April 1971.

†Time and Frequency Division, Institute for Basic Standards, National Bureau of Standards, Boulder, CO 80302.

"Science is the labour and handicraft of the mind . . ."

Francis Bacon,  
*Description of the Intellectual Globe*,  
Ch. 1.

A tutorial discussion of the physical basis of atomic frequency standards is given. These principles are then related to the conditions under which an atom can be used as the working substance of a stable and accurate frequency standard. The three primary examples of atomic frequency standards—the hydrogen maser, the cesium beam, and the rubidium gas cell—are then discussed in terms of these principles and conditions. The functions of the fundamental parts of each device become apparent through this development.

**Key words:** Atomic frequency standards; cesium beam; energy levels; hydrogen maser; hyperfine interaction; Rubidium gas cell; transition probability.

### 3.1. INTRODUCTION

Many people have an interest in modern technological developments. For some, these developments relate to their work and for others, such as students, these devices offer evidence of the realization of basic physical ideas. Atomic frequency standards are an important example of such devices. Not only is their application of significance economically but their design is based upon a foundation of physical theory which is basic to both physics and chemistry—the idea of atoms and atomic structure. The purpose of this paper is to state the physical basis of atomic frequency standards and, having done so, to show how these principles determine the design of the specific devices.

As the reader will observe, I have taken a historical approach in discussing the atomic theory. In so doing, perhaps some of the excitement and beauty of physics will be apparent. If I have been successful in this effort then it may be that some people who are already familiar with the atomic theory will find this work stimulating. Whatever his level of education, the reader should find the essentials of atomic frequency standards given here.

### 3.2. ATOMIC ENERGY LEVELS

“The only existing things are the atoms and empty space; all else is mere opinion”—Democritus (about 400 B.C.).

Today, the atomistic character of matter is taken for granted by almost everyone who has been raised in a technological society. And yet, for 2200 years (from the time of Democritus), a majority of scientists, partly on theological grounds, actively rejected the idea.

As foreign as the atomistic concept is to the human senses, by the early 1800's the study of gases and of chemical composition had made atoms a compelling idea. Atomic frequency devices are intimately tied up with the ideas of atoms, atomic energy levels, and electromagnetic radiation that developed so rapidly from about 1800 to 1930. A discussion of these ideas is essential to the understanding of these devices. These ideas will be discussed in a historical manner with a secondary goal of suggesting the profound changes that took place in physics during this period. The major goal will be to give sufficient detail that the function of the various parts of each device will be obvious.

#### 3.2.1. Four Basic Ideas

The knowledge upon which atomic frequency standards are based developed from the study of the absorption and emission of electromagnetic radiation by matter. This study, which is a branch of spectroscopy, has developed a very elaborate model of the energy level structure of atoms and of their interaction with the electromagnetic field

in an attempt to account for the great number of spectroscopic observations. It is an effort which has been remarkably successful.

#### a. The Electron

The atom, as a miniature solar system, is a model which is familiar to many people. As familiar as this—the Bohr model—is, 100 years of ingenious experiment and profound change in theoretical concept were the necessary preliminary to its birth.

At first it was not necessary to think of atoms as having structure, of being made up of a nucleus and electrons. Progress was made in understanding gases simply by assuming atoms to be spherical objects with mass and a small but nonzero radius. Information about the structure of atoms came from the electrochemical studies of Faraday around 1834. These experiments showed that atoms had electrical charge associated with them; and in fact that the charge comes *only in discrete* amounts—it is not infinitely subdivisible. But neither the mass nor the charge of individual atoms were separately known; rather only the charge to mass ratio. These ratios depended on what substance was used in the experiment, but for any given substance the ratio was constant.

The electron itself, however, could not be isolated by the electrolysis technique, and another 60 years passed before, in 1897, J. J. Thomson conducted an experiment with electric discharges in gases and was able to isolate the electron. This experiment, sometimes called a cathode ray experiment, measured the deflection of a stream of particles—electrons—the particles being deflected by electric and magnetic fields. Nevertheless, this experiment was the same as the electrolysis experiment, in the sense that it gave only the ratio of charge to mass,  $e/m$ . Thomson realized that he had discovered a fundamental characteristic of all atoms because the character of these cathode rays was independent of the gases and metals he used in his experimental apparatus. Another thing Thomson found was that the cathode rays were negatively charged.

The results of Faraday and of Thomson suggested a radically new concept: atoms are normally electrically neutral; they are composed of very light particles—electrons—which have a negative charge and a much heavier other part which has a compensating positive charge. Thomson's work was followed by the Millikan oil-drop experiment in the year 1910. Here, Millikan measured the absolute charge on the electron, and, having  $e/m$  from Thompson's work, the mass,  $m$ , of the electron became known.

#### b. The Nucleus

The positively charged “other part” of the atom was not yet pictured as a very small, and therefore, very dense core—a nucleus. During the period 1909 to 1911, the work of Ernest Rutherford and his



colleagues evolved this profound idea. Their experiment was based on letting alpha particles (the nuclei of helium atoms) coming out of radioactive radium strike a thin metal film. A quotation from Rutherford shows his excitement over the result [1]:<sup>1</sup>

“ . . . I had observed the scattering of  $\alpha$ -particles, and Dr. Geiger in my laboratory had examined it in detail. He found, in thin pieces of metal, that the scattering was usually small, of the order of one degree. One day Geiger came to me and said, ‘Don’t you think that young Marsden, whom I am training in radioactive methods, ought to begin a small research?’ Now I had thought that, too, so I said, ‘Why not let him see if any  $\alpha$ -particles can be scattered through a large angle?’ I may tell you in confidence that I did not believe that they would be, since we knew that the  $\alpha$ -particle was a very fast, massive particle, with a great deal of [kinetic] energy, and you could show that if the scattering was due to the accumulated effect of a number of small scatterings, the chance of an  $\alpha$ -particle’s being scattered backward was very small. Then I remember two or three days later Geiger coming to me in great excitement and saying, ‘We have been able to get some of the  $\alpha$ -particles coming backward . . .’ It was quite the most incredible event that has ever happened to me in my life. It was almost as incredible as if you fired a 15-inch shell at a piece of tissue paper and it came back and hit you. On consideration, I realized that this scattering backward must be the result of a single collision, and when I made calculations I saw that it was impossible to get anything of that order of magnitude unless you took a system in which the greater part of the mass of the atom was concentrated in a minute nucleus. It was then that I had the idea of an atom with a minute massive center carrying a charge.”

#### c. The Quantization of the Energy of Atoms

Two more ideas were necessary ground work for the Bohr model. These were (1) the quantization of the energy of atoms and (2) the quantization of the energy of the electromagnetic (EM) field.

The idea of the quantization of the energy states of matter was conceived by Max Planck around the year 1900. He introduced the idea in his highly successful theory of black-body radiation.

Black-body radiation had been a subject of long-standing interest in the field of thermodynamics as well as spectroscopy. The first, and partially successful theoretical attacks upon this phenomena, were based upon conventional thermodynamic theory and the exceedingly successful electromagnetic theory of James Clerk Maxwell. These approaches were able to give good results for either the long or the short wavelength ends of the emission spectrum, but no one model satisfied the entire spectrum.

Planck based his theory on several assumptions: (1) Matter (as far as thermal radiation is concerned) is made up of an exceedingly large number of electrically charged oscillators. This collection contains oscillators at all possible frequencies. (2) Although all frequencies are represented, any given oscillator has its own specific frequency, say  $\nu$ , and it cannot radiate any other. (3) He further assumed that the amounts of energy that a *given* oscillator could emit

were given by  $E_n = nh\nu$ , where  $\nu$  is the characteristic frequency of the oscillator,  $n$  is an integer (1, 2, 3, . . .), and  $h$  is a constant. The quantity,  $h$ , is a fundamental constant of nature and is known as Planck’s constant. The third assumption is the third of the four basic foundation stones of Bohr’s theory.

So Planck’s ideas succeeded in predicting black-body radiation, but nobody, including Planck, was comfortable with them. To quote Holton and Roller [2]:

“Planck himself was deeply disturbed by the radical character of the hypotheses that he was forced to make, for they set aside some of the most fundamental conceptions of the 19th-century science. Later he wrote that he spent many years trying to save physics from the notion of discontinuous energy levels, but that the quantum idea ‘obstinately withstood all attempts at fitting it, in a suitable form, into the framework of classical theory . . .’”

#### d. The Quantization of the Electromagnetic Field

In 1905, Einstein proposed the following relation as an explanation of the photoelectric effect:  $h\nu = P + E_{k, \max}$  where  $\nu$  is the frequency of the electromagnetic radiation striking the surface from which electrons are emitted,  $E_{k, \max}$  is the maximum kinetic energy of these electrons,  $P$  is a property of the metal being studied, and  $h$  is a constant— independent of the metal being studied and of the frequency  $\nu$ . Eventually, careful measurements showed that this constant,  $h$ , was numerically equal to Planck’s constant, and, with the passage of time, the two constants have come to be accepted as identical— as representing the same immutable aspect of nature.

The idea behind the above equation was that light was quantized—that its energy came in discrete amounts,  $h\nu$ , that it had a particle-like as well as a wave-like character. This new idea was no more acceptable to the majority of scientists than was Planck’s proposal that the energy states of matter were quantized. One might have thought, however, that Planck would have maintained a reserved silence— after all, Einstein’s idea and his own were so analogous and the two constants appeared to be numerically equal. But he did not. In 1910 Planck wrote that, if this new theory of light were accepted “the theory of light would be thrown back by centuries— for the sake of a few still rather dubious speculations” [3].

### 3.2.2. The Bohr Model of the Hydrogen Atom

With these four ideas and with the boldness characteristic of these ideas, Niels Bohr, in 1913, proposed his now famous model of the hydrogen atom. Before discussing the Bohr model, however, it is necessary to admit that it will not allow us to explain all the details of atomic frequency standards. One reason is that the Bohr theory will not correctly predict the intensities of the absorptions and emissions that an atom can undergo. Even so, the Bohr

<sup>1</sup> Figures in brackets indicate literature references at the end of this Chapter.

model is of much more than historical interest. For one thing, it does incorporate the majority of the ideas which we need, and it does provide a mechanistic, intuitive picture of the energy levels of an atom.

Bohr was faced with the problem of both acknowledging the idea of the nuclear atom and of predicting its stability. Precisely what went through Bohr's mind is something that is not known to us, but the similarity between his problem and planetary motion is obvious: In the simplest case there is the sun (nucleus), a very massive body, and a planet such as the earth (electron). The two bodies attract one another with a force which is inversely proportional to the square of their distance of separation.

Bohr knew that the radiation from an atom was associated with its electrons because in 1897 (just after the discovery of the electron by Thomson) Zeeman and Lorentz showed that the radiation coming from an atom was due to a charged particle whose charge-to-mass ratio was the same as that for the electron. Maxwell's theory predicts that if an electron is moving in a circular path with an angular frequency,  $\Omega$ , it will radiate electromagnetic energy at a frequency,  $\nu = \frac{\Omega}{2\pi}$ . This is because the

electron is charged and because of the acceleration experienced in circular motion. The difficulty with the planetary idea is that, as the electron radiates away its energy, it slows down and gradually spirals into the nucleus. Bohr dispensed with the problem of a nuclear crash by assuming an arbitrary restriction.

Bohr's analysis was based on two equations. The first equates the attractive force between the nucleus and the electron to the product of the radial acceleration of the electron and its mass. The second equation sets the angular momentum of the electron,  $mvr$ , equal to a constant,  $nh/(2\pi)$ . Here,  $v$  is the magnitude of the velocity of the electron upon its circular orbit,  $r$  is the radius of this orbit,  $m$  is the mass of the electron,  $n$  is an integer (1, 2, 3, . . .), and  $h$  is Planck's constant. This second equation is completely arbitrary and is in fundamental disagreement with Maxwell's electromagnetic theory because it implies that an electron can travel around a circular path without radiating.

Bohr solved these two equations for the "allowed" orbits, i.e., those particular values of the radius which satisfy both conditions. This results in

$$r = n^2 c, \quad (3.1)$$

where  $c$  is a constant. The smallest value of the integer  $n$  is 1 (unity), and when the electron is in the orbit corresponding to this radius it is said to be in its ground state. (The definition of "ground state" has to be modified for a many-electron atom.) This result is one of the major successes of Bohr's theory because if the constant is evaluated it is found that  $r$ , for  $n=1$ , is approximately equal to  $0.5 \times 10^{-10} m$ . This is in good agreement with the size of the hydrogen

molecule as obtained from the kinetic theory of gases.

The second important result of Bohr's analysis is the expression of the total energy  $E$  of the atom in terms of the integer  $n$ . The result is

$$E = -\frac{1}{n^2} \frac{e^4 m}{8\epsilon_0^2 h^2},$$

where  $m$  and  $h$  are as defined above,  $e$  is the charge of the electron, and  $\epsilon_0$  is the dielectric constant of free-space. By taking the difference between the energies of two orbits, an equation is obtained which predicts many important observations of optical spectroscopy. The result is

$$E_n - E'_n = \frac{me^4}{8\epsilon_0^2 h^2} \left( \frac{1}{n'^2} - \frac{1}{n^2} \right). \quad (3.2)$$

When energy is absorbed or emitted the electron makes a corresponding change in orbit—this is commonly called a transition. Figure 3.1 shows the energy level diagram for the hydrogen atom. The

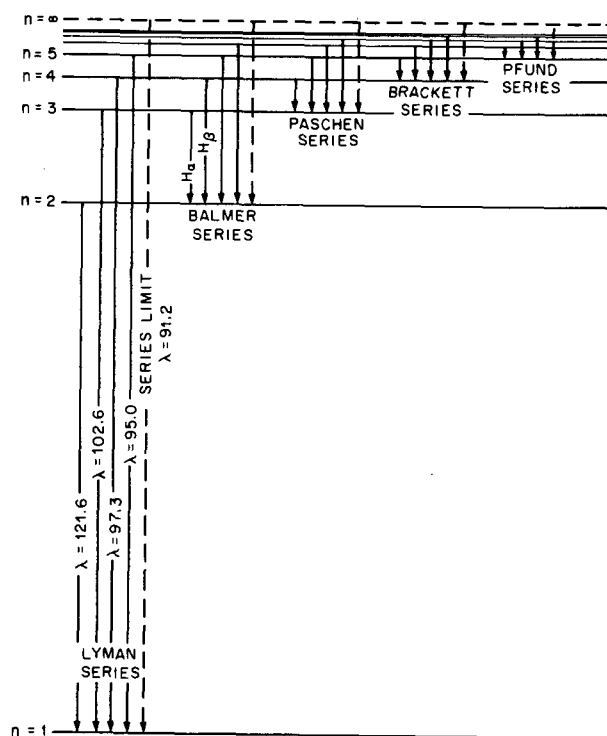

Fig. 3.1. The energy level diagram of the hydrogen atom as obtained from the Bohr theory. The wavelengths (of the Lyman Series) are given in nanometers, nm (1000 Angstroms equals 100 nm).

vertical lines represent possible transitions. To understand the experimental results of optical spectroscopy it was useful to group the various emissions. These groups were given names according to those people who had devoted the most study to them, Lyman, Balmer, etc. For the hydrogen atom, transitions to the  $n=1$  level involve radiation whose wavelengths are of the order of 100 nm (1000 Angstroms). This corresponds to a frequency of  $3 \times 10^{15}$  hertz. (A hertz is equal to one cycle per second.) However, when the effects of the intrinsic magnetic moments of the electron and the nucleus are included, it turns out that additional levels are available whose spacings are at microwave frequencies (somewhere between  $10^9$  and  $10^{11}$  hertz). Before discussing these effects, I need to talk about an entirely different basis for calculating the characteristics of an atom. This approach is essential for obtaining the probabilities of transitions between the various levels—a subject which is crucial to atomic frequency standards. This theory is called quantum mechanics.

### 3.2.3. Quantum Mechanics

It was not just its inability to account for all of the experimental data that left something to be desired in the Bohr theory. It was the fact that this theory—just as the black-body theory of Planck and the photoelectric theory of Einstein—was an intellectually uncomfortable, ad hoc, combination of the old ideas of classical physics and the new idea of quantization. These conceptual difficulties were removed with the advent of quantum mechanics

This new theory was developed separately, and nearly simultaneously, by Erwin Schrödinger and Werner Heisenberg about 1926. The work of these two men, at first sight, seemed quite different; but it was soon shown that, despite their difference in mathematical form, they were physically equivalent. A brief description of Schrödinger's theory is given here. Schrödinger's theory takes the form of a partial differential equation. Specifically, it is an equation involving the rate of change of a quantity,  $\psi$ , with respect to the variables of space and time. In its original form, this equation was designed to predict the possible values of energy which could be possessed by a material body. In its generalized form it is used to calculate any measurable property of a particle. The quantity  $\psi$  is usually referred to as a wave function. The physical meaning of this quantity was, at first, quite uncertain. It is now generally agreed, however, that the square of the magnitude of  $\psi$ , at any given point in space, represents the probability of finding the particle at that point in space.

This probabilistic interpretation is perhaps the key feature of the new physics—of quantum mechanics—which says that particles have a wave-like aspect. Einstein based his photoelectric theory on the idea that light had a particle-like property. In

1924, Louis de Broglie turned the cart around by suggesting that a particle has a wavelength associated with it. In other words, a particle has some of the characteristics of a wave. In particular he said that the wavelength,  $\lambda$ , of a particle should be given by  $\lambda = \frac{h}{mv}$  where  $h$  is Planck's constant and the product,  $mv$ , is the momentum of the particle. To quote de Broglie [4]:

“Determination of the stable motion of electrons in the atom introduces integers; and up to this point the only phenomena involving integers in physics were those of interference and of normal modes of vibration. This fact suggested to me the idea that electrons, too, could not be regarded simply as corpuscles, but that periodicity must be assigned to them.”

Schrödinger's equation brings together in a natural way the localized (what we usually call the particle aspect) and wave-like aspects of a particle. This is very clearly seen in the solution of Schrödinger's equation as applied to the hydrogen atom. Some of the results of the solution are: (1) The atom can have only certain discrete values of energy, and these values are associated with an integer,  $n$ . This is qualitatively and quantitatively the same result as obtained from the Bohr theory, but, (2) although for any given energy the electron has a high *probability* of being found in a restricted region about the nucleus, it has some chance of being found anywhere, and certainly it is not to be thought of as being localized on orbits as in the Bohr model. (3) In solving for the H atom it is found that two more integers,  $l$  and  $m_l$ , occur as a natural result of the solution. Thus we get three numbers,  $n$ ,  $l$ , and  $m_l$ , each of which are integers. These integers are called quantum numbers, and they represent the fact that here *three* properties of the atom are quantized. They are: The energy, represented by  $n$ ; the total orbital angular momentum, represented by  $l$ ; and the projection of the total angular momentum, along some specified direction, represented by  $m_l$ . The importance of these additional quantum numbers will be discussed in Section 3.4.1.

It is apparent that the theory of matter and electromagnetic energy has gradually become more and more abstract, less and less intuitive. Despite the fact that quantum mechanics is a profoundly different concept than that used by Bohr, he was prepared to accept the increasing abstraction—he wrote [5]:

“To the physicists it will at first seem deplorable that in atomic problems we have apparently met with such a limitation of our usual means of visualization. This regret will, however, have to give way to thankfulness that mathematics in this field, too, presents us with the tools to prepare the way for further progress.”

### 3.2.4. Spin—Additional Energy levels

The spectrum of the hydrogen atom, when looked at with sufficient precision, is found to have some significant disagreements with the Bohr model.

These discrepancies take the form of shifts in energies of the various levels. Looked at on an even finer scale, it is found that nearly all of the lines split into two lines so that there are more levels in the actual spectrum of hydrogen than Bohr predicted. For a time it appeared that if Bohr's theory were generalized to include both elliptical orbits and Einstein's theory of special relativity (the Bohr-Sommerfeld theory), the shifts (but not the extra lines) could be accounted for. Later, however, it became clear that there were inconsistencies in this approach. Then, in 1925, Uhlenbeck and Goudsmit showed that the observed shifts in energy could be obtained by assuming that electrons intrinsically possess angular momentum and a magnetic moment. In 1924, W. Pauli had suggested that the properties of intrinsic angular momentum and magnetic moment be attributed to the nucleus of an atom as a possible means of explaining some of the other details of atomic spectroscopy. It is now commonly accepted that these two properties are as much a part of the intrinsic character of electrons and nuclei as are those of mass and charge. The two properties of intrinsic angular momentum and magnetic moment are inseparable and are often referred to by the single name-spin.

The existence of the spin properties of the nucleus and electron means that there are additional forces between these two particles for which Bohr's theory did not account. Thus, in the more detailed theory, the energy level structure is modified. For our purpose, the result of all this is that there are additional energy levels, some of which have a separation corresponding to microwave frequencies.

### 3.3. THE INTERACTION BETWEEN ATOMS AND ELECTROMAGNETIC RADIATION

Section 3.2 discussed the idea that any given atom can only exist in certain discrete states and that each state has a definite energy. If an atom is not able to interact with other atoms it can only change its state by absorbing or emitting electromagnetic (EM) energy. This absorption (or emission) is the means whereby we know that the energy level structure exists. In the case of atomic frequency standards the EM radiation which causes these transitions is directly related to the output of the standard. It is the purpose of this section to show that the probability of making these desired transitions depends upon the frequency and upon the intensity of the EM field and that the atom must have a non-zero magnetic moment. In this paper I consider only elemental atoms and not molecules. If the output frequency is to be well defined, it is also necessary to have the atoms interact with the EM field for a fairly long time.

#### 3.3.1. Maxwell's Theory of Electromagnetic Radiation

The earliest work in spectroscopy involved looking at the various colors of light that were emitted and absorbed by heated solids, liquids, and gases. The detailed work in this field had begun by the mid-18th century. At this time, light was generally held to be corpuscular in nature, i.e., not a wave. By the first part of the 19th century, however, the tables had been turned in favor of a wave theory of light. This was due in major part to the work of Thomas Young and Augustin Fresnel in studying the phenomena of diffraction, interference, and polarization. The theoretical work of Maxwell and the experimental work of Heinrich Hertz near the end of the 19th century seemed to give the final, irrefutable evidence in favor of a wave theory as opposed to a corpuscular theory of light.

By the mid-19th century the most important facts of some two centuries of study of electricity and of magnetism were embodied in four equations. It was Maxwell's remarkable contribution to realize that if one of these four relations (Ampere's law) were modified it would resolve a problem in understanding the conservation of charge, and it would allow the four equations to be combined to form wave equations for both the electric and magnetic fields. That is to say, these equations predicted EM radiation. It was only some five years later, in 1888, that Hertz conducted experiments which verified Maxwell's predictions including the prediction that the wave would propagate with the speed of light. The obvious conclusion is that light is an electromagnetic wave!

Maxwell's theory of the EM field says that the field's intensity can vary *continuously* from zero to any arbitrary value. In Section 3.2.1.d., however, Einstein's studies of the photoelectric effect were discussed, and his conclusion was that the energy of a light wave is quantized. (Actually, EM radiation has both particle-like and wave-like properties. In most experimental situations, however, one aspect predominates over the other.) Although the particle-like aspect of radiation was important to Bohr in his theory of the atom, for most of our purposes we need only to make use of the fact that the radiation that causes transitions is electromagnetic in nature and to treat its energy as continuously variable. (But see the discussion on particle detection in sec. 3.5.1.a.)

#### 3.3.2. The Dependence of Atomic Transitions upon EM Radiation

The dependence of the transition probability upon the EM field was first studied by Einstein. This work (which was a further examination of black-body radiation) assumed that there were two mechanisms for emission of radiation—induced and

spontaneous—and, also, that absorption, like induced emission, depended on the strength of the EM field and the duration of the interaction. His calculations showed that the probability per atom per unit of time for induced emission  $B_{nn'}$  was equal to that for absorption  $B_{n'n}$

$$B_{nn'} = B_{n'n}. \quad (3.3)$$

This is a very important fact and will be discussed further in Section 3.4.2. He also found that the coefficient for spontaneous emission  $A_{nn'}$  was related to the coefficient  $B_{nn'}$  by  $A_{nn'} = \frac{8\pi\nu^3 h}{c^3} B_{nn'}$ . In

the microwave region (say  $10^{10}$  hertz)  $\frac{8\pi\nu^3 h}{c^3}$  is a very small quantity, and hence spontaneous emission—which causes noise—has, to date, not been a problem in atomic frequency standards. (Noise is any disturbance that tends to obscure the desired signal.) It is, however, an important factor in the infrared and visible radiation regions, as, for example, in state selection for the rubidium gas cell (see sec. 3.5.4).

A quantum mechanical (QM) analysis gives similar results. The result that the induced emission and absorption probabilities (per atom) are identical is obtained in both cases. In the QM case these probabilities again depend on the intensity of the EM field and upon the duration of interaction, but because it can be more detailed, the QM analysis produces some new results which are of particular use in atomic frequency standards.

In the Einstein calculation, no explicit dependence upon the frequency  $\nu$  is obtained for the coefficient  $B_{nn'}$ , but the QM result does have an explicit frequency dependence. In atomic frequency standards the atoms are in a gaseous state at very low pressure when interacting with the EM field. To a very good approximation, we need only consider the interaction with a free atom, and, if the QM analysis is done for this case, the following is obtained:

$$P_{nn'} = \sin^2 \theta \sin^2 \frac{a\tau}{2}. \quad (3.4)$$

$P_{nn'}$  is the probability of making a transition from state  $n$  to  $n'$  after a time interval  $\tau$  if the atom was in state  $n$  at the beginning of the interval. The quantity  $\sin \theta$  is defined as  $-2b/a$ , where  $a \equiv [(\Omega_0 - \Omega)^2 + (2b)^2]^{1/2}$ . Here,  $\Omega_0 \equiv \frac{2\pi}{h} (E_n - E_{n'})$ , and  $b$  is the product of the magnetic moment of the atom and the strength of the EM field which is exciting it. The symbol  $\Omega$  is defined as  $2\pi\nu$ . One of the things this result shows is that for  $P_{nn'}$  to be nonzero, the atom must have a nonzero magnetic moment when in either state  $n$  or  $n'$ .

In figure 3.2,  $P_{nn'}$  as given by eq (3.4), is plotted versus  $(\Omega - \Omega_0)/(2b)$  for several cases. The dashed curve shows that if the radiation frequency is equal

to the frequency difference associated with the two levels, i.e.,  $2\pi\nu = \Omega_0 = (E_n - E_{n'}) \frac{2\pi}{h}$ , then—after the time interval  $\tau = \pi/(2b)$ —the atom is sure to have made the transition between state  $n$  and state  $n'$ . The dashed curve assumes that the EM field is interacting with a single atom or a group of atoms all moving with the same velocity.

In a real device the atoms have different velocities; the solid curve shows the result of averaging eq (3.4) over a Maxwellian velocity distribution. This curve applies to the specific case of the interaction time  $\tau$  being equal to  $1.2\pi/(2b)$ . This is the interaction time for which the transition probability will be largest. The dotted curve gives the transition probability for  $\tau$  much greater than  $\pi/(2b)$ . The basic conclusion from eq (3.4) and figure 3.2 is that for a given value of the interaction time, the transition probability will be maximized for  $\Omega = \Omega_0$  and that this maximum value depends upon both the magnetic moment of the atom and the strength of the EM field.

### 3.3.3. Transition Probability and Linewidth of Actual Frequency Standards

Until now I have been emphasizing the maximum value of the transition probability curve—its value when  $\Omega = \Omega_0$ . The extent to which this curve spreads out is also important, and I will now discuss this point.

The purpose of a frequency standard is to provide an output which is as nearly a single frequency as is possible. There are certain features of the real world that inevitably cause the output of an actual standard to be less than perfect. The nonzero width of the transition probability curve, as displayed in figure 3.2, is an important example of one of these degrading features. In an active device—a device which generates its own EM field—the meaning of this nonzero width is that the device emits observable energy over a range of frequency. [The linewidth of a resonance curve is usually defined to be the difference (in frequency) between those two frequencies at which the intensity is one-half its peak value.] The intensity of the undesired energy falls off rapidly as its frequency deviates from  $\nu_0$  by more than one linewidth.

A passive device—a device where the EM field is supplied by an external source—also has a nonzero linewidth.

We are now in a position to see two important requirements of a high-quality frequency standard. First, the peak value of the transition probability must be high enough that the signal can be seen above the noise, and second, the interaction time must be long enough to make the linewidth sufficiently narrow. In Section 3.5, the means by which these two goals are achieved will be discussed.

In the case of atomic frequency standards, there is a useful relationship between the linewidth,  $W$ , of the frequency response and the interaction time  $\tau$ .

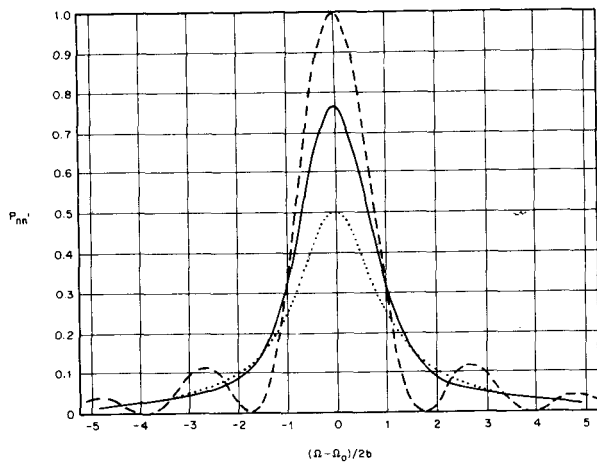

Fig. 3.2. Theoretical curves of  $P_{nm}$ . The dashed curve is obtained from eq (3.4) by setting  $\tau = \pi/(2b)$ . The full curve is obtained from an average over the velocity distribution and with an optimum  $\tau$  ( $\tau = 1.2\pi/(2b)$ ). The dotted curve comes from an average over the same velocity distribution but with  $\tau \gg \pi/(2b)$ . (See text for further details.) (This figure is a modification of Fig. V.1 of *Molecular Beams* by Norman F. Ramsey, copyright by Oxford University Press, 1956).

For example, in an ideal cesium beam (monovelocity beam) using “two-cavity” excitation (see item 4 of sec. 3.5.3),  $W$  and  $\tau$  are related by

$$W\tau = 1/2. \quad (3.5)$$

For other high quality atomic frequency standards, the  $W\tau$  product is also of the order of unity. Equation (3.5) makes the importance of the parameter  $\tau$  obvious: The linewidth of the atomic resonance improves linearly with increasing  $\tau$ .

### 3.4. CHOOSING A SUITABLE ATOM

Sections 3.2 and 3.3 discussed two fundamental facts of physics, atomic energy levels and the interaction of atoms with electromagnetic fields. These facts are the basis for atomic frequency standards. We need now to decide how to choose a suitable atom.

#### 3.4.1. The Energy Levels of a Many-Electron Atom

The purpose of this subsection is to describe the energy level structure of atoms with more than one electron. In order to understand this structure it is useful to consider a basic experimental result of spectroscopy.

For simplicity's sake, consider the simplest of atoms—hydrogen. If a gas made up of hydrogen atoms is heated to a high temperature, then it will

emit EM energy. This energy is emitted at discrete frequencies. In the range of visible light, the standard means of observing these radiations is to use an optical spectrograph. This device causes the energy at the various frequencies to be split up spatially so that if it is directed onto a strip of photographic film, the developed film shows a group of lines known as the Balmer Series. These are so labeled in figure 3.3. The response of the photographic film is limited to visible light but if it could respond to higher and to lower frequencies, additional groups of lines, which are also shown in figure 3.3, would result. For any given group, it can be seen that the lines become very closely spaced towards their high frequency (short wavelength) end. The terminal frequency for each group is indicated by dashed lines in the figure. The dashed line for a given group is called the series limit for that group. The importance of the series limit is that it tells us about a particular energy level which is common to every line in the group. Now, the emission spectra of gases of any other kind of atom are fundamentally the same as that of hydrogen. This basic characteristic is often hard to see in the other atoms because there are more energy levels involved and sometimes the various series (groups) overlap. Nevertheless the spectra of any atom is composed of an infinite number of these series (groups) of lines. Because of this, the frequency of any line of any series in any atom can be obtained from an equation of the same form as eq (3.2). The equation has the general form:

$$\nu = T_2 - T_1. \quad (3.6)$$

$T_2$  and  $T_1$  are called spectroscopic terms.  $T_2$  is the generalized *common* term of a given series of lines.

As spectroscopists began to look more closely at the spectrum of atomic hydrogen, they found that most of the lines of the spectrum, which had previously appeared to be single, were actually double. Before having discovered these double lines, they had found that to classify all the lines in the spectrum unambiguously, they needed two (not one) quantum numbers,  $n$  and  $l$ . Now, with double the number of lines, four quantum numbers were necessary. The extra numbers that are needed are  $s$ , the quantum number of the spin of the electron, and  $j$ , the quantum number of the total angular momentum of the electron. The spectra of all other atoms also require four quantum numbers to characterize each line (energy level). (I should state here that I am temporarily ignoring the extra complication of the interaction of the atom with an externally applied dc field.) At first these four numbers were just an empirical scheme for specifying the levels, but in time they were given meaning in terms of the structure of the atom. The labels used are the principle number  $n$ —which is analogous to the  $n$  of the Bohr theory; the total orbital angular momentum number  $L$ ; the total electron spin number  $S$  and the total angular momentum number  $J$ .

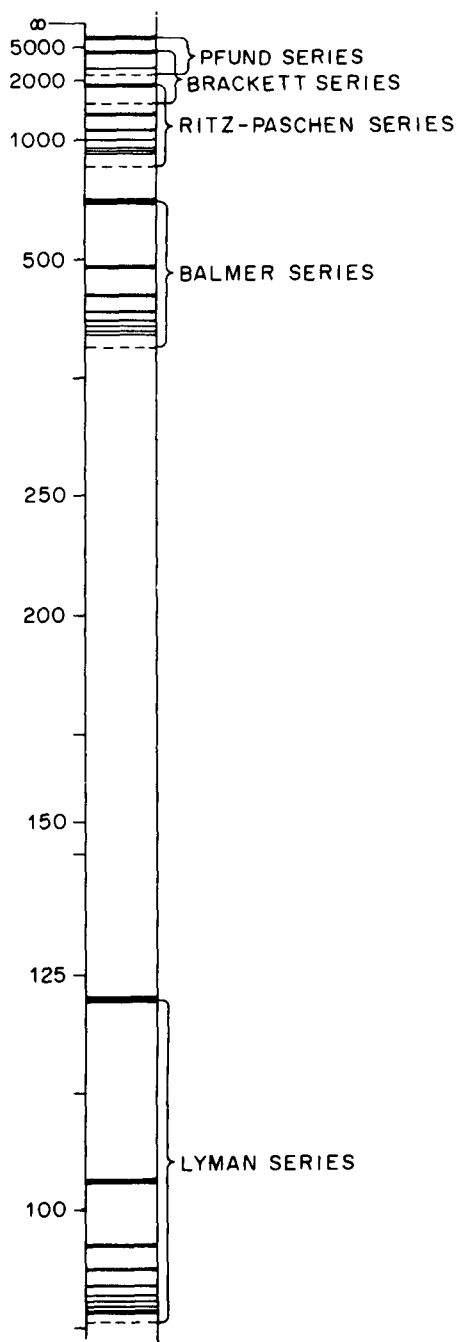

Fig. 3.3. Schematic diagram of the emission spectrum of the hydrogen atom. The intensity of the emission is roughly indicated by the thickness of the lines. The dotted lines are series limits. The wavelength scale is in nanometers. (This figure is a modification of Fig. 8 of *Atomic Spectra and Atomic Structure* by Gerhard Herzberg, copyright by Dover Publications, 1944.)

In atoms with more than one electron, there is not only the electrostatic force between an electron and the nucleus, and the force between the orbital and intrinsic moments of an electron, but also the electrostatic and magnetic forces between electrons. These forces determine the energies and therefore the frequencies corresponding to the possible transitions between states. An important reason for using  $n$ ,  $L$ ,  $S$ , and  $J$  in labeling the levels is that each of these quantities is usually important in characterizing the energies of the levels. The quantity  $L$  is formed by means of certain quantum mechanical rules from the  $l$ 's of the individual electrons. The quantity  $S$  is formed in a similar manner. The number  $J$  is then formed from  $L$  and  $S$ , again, using the appropriate quantum mechanical rules. Now, you may ask, "Why were all the  $l$ 's combined to form  $L$  and  $s$ 's to form  $S$ , why not combine the individual  $l$ 's and  $s$ 's to form  $j$ 's (the total angular momentum for individual electrons) or even some intermediate scheme?" The method used here implies that the coupling of the individual orbital momenta and the individual intrinsic momenta is very strong with respect to the coupling of the orbital and intrinsic momenta of a given electron. This is commonly called Russell-Saunders coupling and usually applies to the ground state of any atom; this is the state of interest to us.

To gain insight into the quantum number  $n$ , and as a general aid in understanding the energy level structure of an atom, the Pauli Exclusion Principle is extremely useful.

One of the most prominent features of nature is the periodic behavior of the elements. This periodicity expresses itself in the emission (and absorption) spectra we have been discussing and in the chemical behavior of the elements as first summarized in 1869 by Dimitri Mendeleev. The periodicity is explainable by the Pauli Principle. This principle is to be taken as a postulate, as fundamental as the concepts of mass and charge. Wolfgang Pauli, in 1925, proposed this principle as a hypothesis based upon his observations of the spectra of the alkali metals. The principle says: "In an atom there never are two electrons having the same group of four quantum numbers." The numbers referred to are  $n$ ,  $l$ ,  $j$ , and  $m_j$ . (The values of  $m_j$  are the projections of  $j$  along a dc magnetic field.) In his book on quantum mechanics, Persico [6] says: "It may be said that the entire theoretical interpretation of spectra is based upon this principle and constitutes an impressive confirmation thereof." Using Pauli's Principle as a theoretical guide, calculations show that, roughly speaking, the electrons gather into localized groups called shells. Figure 3.4 displays this result. These shells are analogous to the orbits of the Bohr theory and are labeled by the quantum number  $n$ . To be rigorous about the interpretation of figure 3.4 would require a much deeper discussion of quantum mechanics than the purpose of this article allows. The point, however, is that the Pauli Principle determines the number of electrons that can be

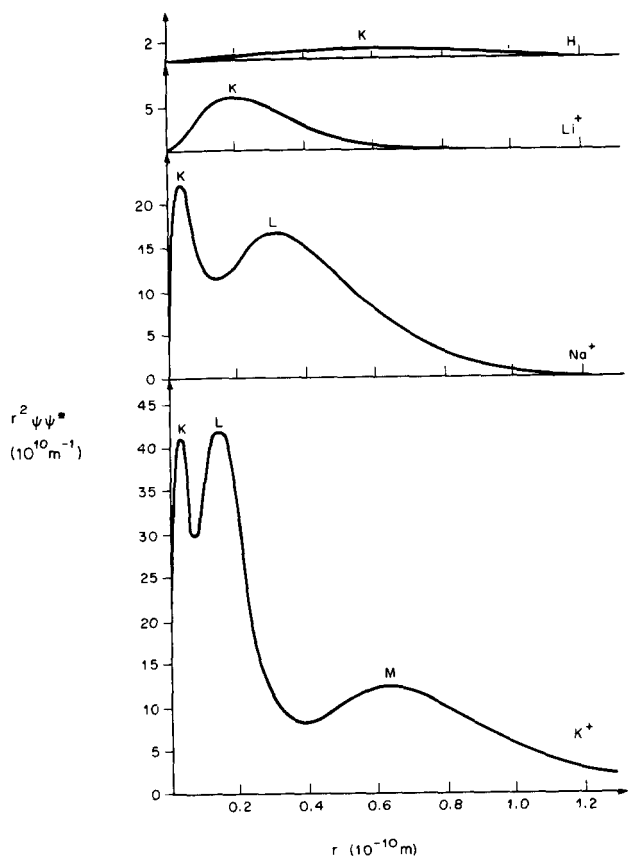

Fig. 3.4. Charge distribution for the ground states of H, Li<sup>+</sup>, Na<sup>+</sup>, and K<sup>+</sup>. The concentrations of charge (corresponding to the maxima) in these distributions are analogous to the orbits of the Bohr theory and are called shells. The area under the curves is proportional to the number of electrons in the atom. The vertical axis is equal to  $r^2\psi\psi^*$  where  $r$  is in meters. (This figure is a modification of Fig. 54 of *Atomic Spectra and Atomic Structure* by Gerhard Herzberg, copyright by Dover Publications, 1944.)

located in each shell. The letters K, L, and M are the traditional labels of the first three shells. Another noteworthy thing observable in this figure is that the radius of the K shell (and the L shell) decreases markedly as we go to atoms with more electrons. The reason for this is that the heavier atoms have a nucleus with a larger charge and therefore the attraction on the electrons in the inner shells is larger.

At this point the discussion can be considerably simplified by admitting that we are not interested in the most general energy states of an atom that could possibly occur but rather in those that have to do with an atom's emission electrons. In atoms other than the noble gases, there are one or more electrons which are much more easily caused to go into an excited state than are the rest. These electrons are called emission electrons because the emission spectra of an atom is usually due to them.

These emission electrons lie outside the filled shells and, to a first approximation, the rest of the atom (the nucleus and nonemission electrons) appears as a point charge to these electrons. Now, in the usual case there is more than one emission electron and the energy of these electrons depends not only upon their quantum number  $n$  (they are usually in the same shell), but upon the "sum",  $L$ , of the  $l$ 's of the emission electrons and also upon their  $S$  and  $J$  values. The values that  $L$ ,  $S$ , and  $J$  can assume are restricted by the Pauli Principle.

To sum up, any given term (energy level) is labeled by the four quantum numbers,  $n$ ,  $L$ ,  $S$ , and  $J$ . Figure 3.5 is an energy level diagram for the single emission electron of potassium. This figure makes use of the quantum numbers. The number  $n$  identifies the shell (see the discussion of the Pauli Principle for the meaning of the word shell). The capital letter that heads each column represents the total orbital angular momentum  $L$ . The letter  $S$  (not the quantum number  $S$ ) means an  $L$  value of 0;  $P$  means an  $L$  of 1;  $D$  means an  $L$  of 2; and  $F$  means

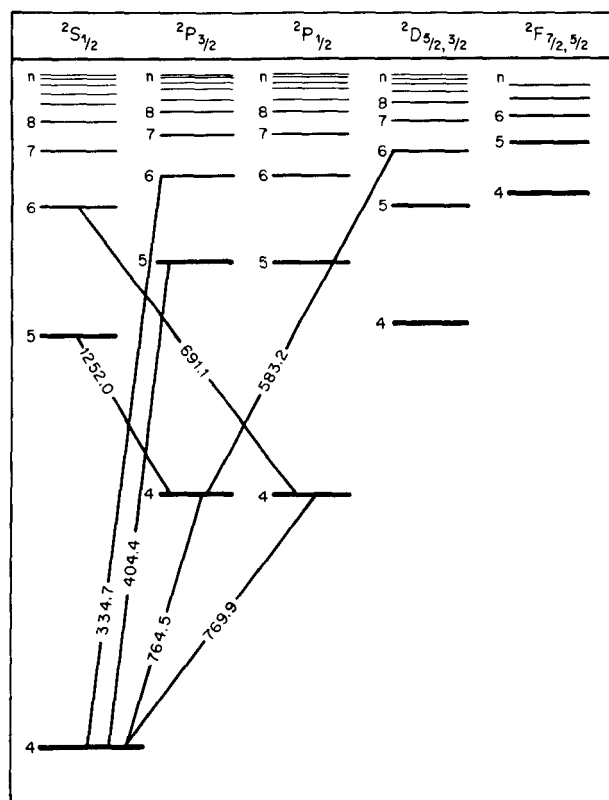

Fig. 3.5. The energy level diagram for the emission electron of the potassium atom. The dependence of energy upon the principle quantum number  $n$ ; the total orbital angular momentum; and the total angular momentum is shown. The figure gives the wavelengths (in nm) for some of the transitions. See the text for an explanation of the labeling of the levels. (This figure is a modification of Fig. 28 of *Atomic Spectra and Atomic Structure* by Gerhard Herzberg, copyright by Dover Publications, 1944.)



an  $L$  of 3. The superscript is equal to  $2S + 1$ . (I am now talking of the quantum number  $S$ .) For potassium,  $S = \frac{1}{2}$ , therefore,  $2S + 1 = 2$ . The subscript is the  $J$  value of the energy level. For  $S = \frac{1}{2}$  there are only two possible values for  $J$ ,  $L + \frac{1}{2}$  and  $L - \frac{1}{2}$  (except that for  $L = 0$ ,  $J$  can only be equal to  $\frac{1}{2}$ ).

For small values of  $n$  there is an observable vertical separation (an energy difference) between the  ${}^2P_{3/2}$  and  ${}^2P_{1/2}$  states. The amount of separation between levels with different  $J$  value depends upon  $L$  as well as upon  $n$ , and it can be seen that levels  ${}^2D_{5/2, 3/2}$  and levels  ${}^2F_{7/2, 5/2}$  are so close in energy that they can't be distinguished on this plot. Thus, they are not separately displayed. From figure 3.5, it is not apparent that it is necessary to specify  $S$ . But in spectra where  $S$  also changes, then the need for the extra quantum number becomes apparent. Note that the ground electronic state of the emission electron is  $4^2S_{1/2}$  where the 4 represents the fourth shell.

### 3.4.2. The Hyperfine Interaction

The magnetic interaction between the nuclear spin—which is symbolized by the letter  $I$ —and the spin of an electron is called a hyperfine interaction.

It is this interaction which causes the desired spacing between the pair of energy levels used in several important frequency standards. Figure 3.6(a) shows how the ground electronic state  ${}^2S_{1/2}$  of the hydrogen atom is split into two states by the hyperfine interaction. One of these two states (the  $F = 1$  state) is then further split by the dc magnetic field,  $H$ . This figure also shows the dependence of the energies of each level upon  $H$ .

The letter  $F$  labeling the ordinate in figure 3.6(a) represents the quantum number of the total angular momentum of the entire atom. This number is formed from  $J$  and  $I$  just as  $J$  is formed from  $L$  and  $S$ . That is,  $F_{\max} = J + I$  and  $F_{\min} = |J - I|$ . Every integer value in between  $F_{\max}$  and  $F_{\min}$  is also allowed. The nuclear spin has only one possible value, and, because we are interested only in the  ${}^2S_{1/2}$  state,  $J$  has only the one value,  $1/2$ . Thus, for the hydrogen atom, which has an  $I$  value of  $1/2$ , there are only two possibilities for  $F$ . Here,  $F_{\max} = 1$  and  $F_{\min} = 0$ , and no intermediate values are possible (see fig. 3.6(a)). I have restricted the atom to be in the  ${}^2S_{1/2}$  electronic state for reasons to be discussed in Section 3.4.3.

To deal with an external magnetic field we need yet another quantum number  $m_F$ . This new number

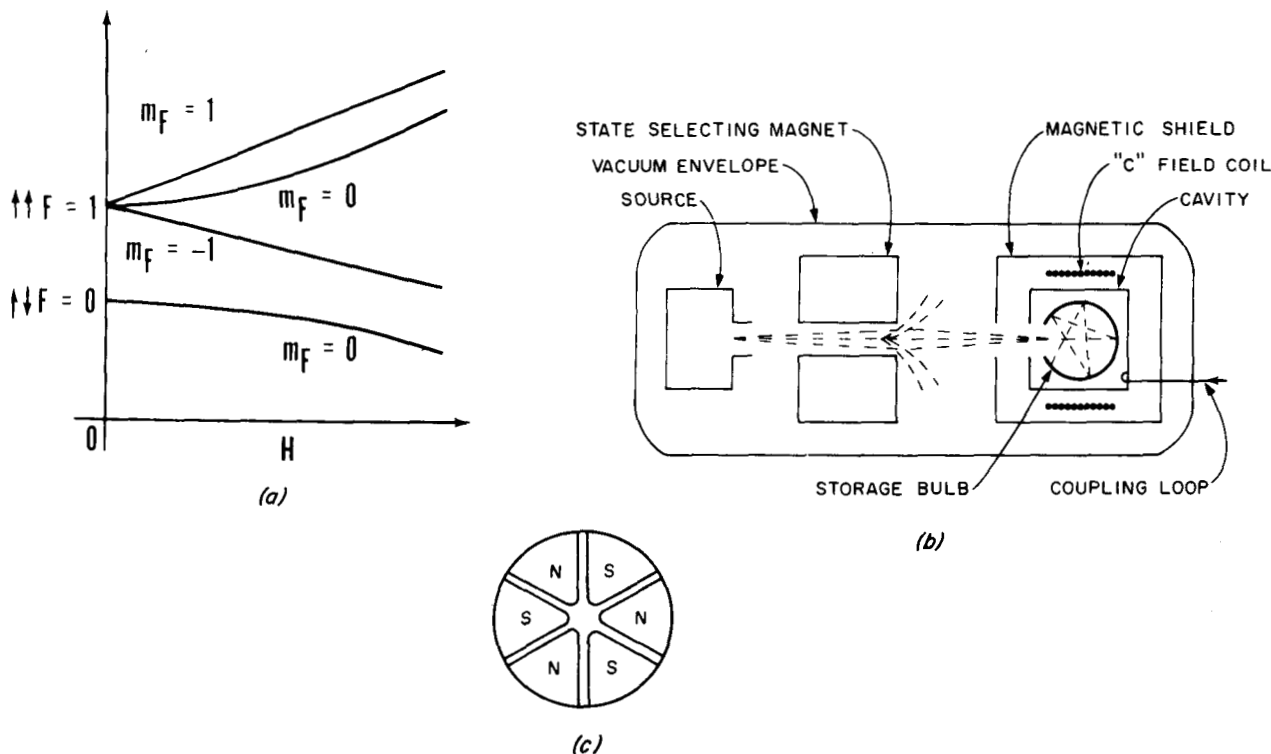

Fig. 3.6. Part (a) gives the energy levels for the ground electronic state ( $1^2S_{1/2}$ ) of the H atom. Part (b) is a schematic of the H maser. Part (c) is the end view of the hexapolar state selecting magnet typically used in an H maser.

refers to the possible projections of  $F$  along the direction of  $H$ . Quantum mechanics allows  $F \cong m_F \cong -F$ . Therefore, for  $F=1$ , the possible values of  $m_F$  are 1, 0, and  $-1$ . For the hydrogen atom, figure 3.6(a) shows that the two energy levels between which we want transitions to take place are the  $F=1, m_F=0$ , and  $F=0, m_F=0$ . This is so because these are the levels which have the least dependence on  $H$  for low values of the field (see item (f) of sec. 3.4.3). [This transition is sometimes symbolized by  $F, m_F=1, 0 \leftrightarrow 0, 0$ .]

### 3.4.3. Criteria for Choosing an Atom

I can now list those characteristics that are desired in an atom for the purpose of a frequency standard and then, based on the Pauli Principle and the spectroscopic information discussed above, decide which atoms are most suitable.

The following are criteria for choosing a suitable atom:

- (a) There should be a high probability of finding the atom in the desired state.
- (b) The transition frequency should be in a useful range.
- (c) The magnetic moment should be large enough for a useful interaction with the EM field and also for the purpose of state selection.
- (d) The atom should be quite inert to interaction with like atoms or with any container in which it is stored.
- (e) The atom should have a low ionization potential if the transition is to be sensed by means of ionized particle detection.
- (f) The energy levels between which the desired transition occurs should have as little dependence as possible upon  $H$ .

As each of these items is discussed it will become apparent that several of these requirements are mutually contradictory, and a compromise has to be reached.

Item (a) basically requires that the desired transition be due to the ground electronic state of the emission electron and that the first excited state of this electron should be significantly higher in energy. Hydrogen, rubidium, and cesium are the three atoms that have seen most use for frequency standards, and one reason is that the ground electronic state in each case is  $^2S_{1/2}$ . This type of state has, in general, the highest possible separation from the first excited state.

The question of what is a useful range for the transition frequency—item (b)—involves many things. The one aspect of this question which properly belongs in this article was discussed above. This subject is the hyperfine interaction. The reader should be reminded, however, that a study of atomic frequency standards is incomplete if these other topics are not considered. For example, in masers, the absolute value of the transition frequency influences the ease of detecting the maser output. In passive devices, such as the cesium and rubidium

machines, the spectral purity of the external microwave signal depends upon the transition frequency. For a discussion of these and other points, see reference [7]. When all the considerations are taken into account, it turns out that a transition frequency lying in the microwave range is quite desirable. The hyperfine interaction often produces energy level spacings in this region.

The importance of the magnetic moment of the atom—item (c)—was discussed in Section 3.3.2. It was pointed out that if a frequency standard is based upon a magnetic interaction; and the highest quality devices are (I continue to restrict myself to devices based on atoms and not molecules, but see the summary), then the net magnetic moment must be non-zero. State selection, to be discussed in Section 3.4.4, also requires that the net magnetic moment be nonzero. In the most general case, the net moment is made up of contributions from the orbital and spin magnetic moments of the electrons and from the magnetic moment of the nucleus. The hyperfine interaction (which determines the transition frequency) is crucially dependent upon the nuclear moment, but, because the nuclear moment is about 1000 times smaller than that due to the electrons, it can be ignored in calculating the net magnetic moment. If the net magnetic moment is too large, then the interaction of the atoms with themselves and with their container will result in broadening the linewidth,  $W$ , and in a frequency shift. It turns out that the parameters involved in practical frequency standards are such that an atom in the  $^2S_{1/2}$  state (hydrogen and the alkali metals, Li, Na, K, Rb, Cs, and Fr) will satisfy the magnetic moment requirements. This is fortunate because an atom in this state also best fits the requirement of item (a).

It can be seen that the desirability of being inert—item (d)—is in conflict with item (c). The noble gases best fit the inert requirement, but, because their ground state is  $^1S_0$ , they have zero net magnetic moment. Atoms whose ground state is  $^2S_{1/2}$  (such as H, Rb, and Cs) form a reasonable compromise because they satisfy items (a), (b), and (c) and yet have a very small magnetic moment.

But the alkali metals are surely not chemically inert—they are among the most chemically active of all of the elements—and a large price is paid in the accuracy of the hydrogen maser (see sec. 3.5.2) because of this.

Item (e) points up again the conflict between the various requirements. One way of sensing that the desired transition is occurring is to collect the atoms which have made the transition. This is done by ionizing those atoms and collecting the charged particles thus generated. If an atom is to be ionized efficiently then its ionization potential must be fairly low. But a low ionization potential guarantees high chemical activity so, again, there is a conflict. The alkali metals all have low ionization potentials, and cesium is particularly good in this regard.

An external dc magnetic field—item (f)—is another source of frequency shift. For example, even

using the  $F=1, m_F=0$  and the  $F=0, m_F=0$  energy level pair in hydrogen, several layers of magnetic shielding are required if this shift is to be reduced to a tolerable level.

### 3.4.4. The Need for State Selection

In order for any atomic frequency standard to work, it is necessary to have a difference in population between the two energy levels of interest. That is, there need to be more atoms in one energy level than in the other. The reason for this is that the absorption probability,  $B_{n'n}$ , is equal to the induced emission probability,  $B_{nn'}$  (see sec. 3.3.2). Thus, if there are the same number of atoms in the upper and lower states, then energy is absorbed by atoms in the lower state as fast as it is emitted by those in the upper state. In a maser, there must be more atoms in the upper than in the lower state. It is this excess in the upper state that provides the energy for the emission of EM energy. In the passive devices, a population imbalance is required because, if the upper and lower states are equally populated, there is no net response to the externally applied radiation.

About 1860, James Clerk Maxwell and Ludwig Boltzmann considered the problem of the relative population of the energy levels of a system with many possible levels. Equation (3.7) gives the result applicable to our case.

$$\frac{n}{n'} = \exp \left[ \frac{-(E_n - E_{n'})}{kT} \right]. \quad (3.7)$$

Here,  $n$  is the number of atoms in the upper energy state whose energy is  $E_n$ , and  $n'$  is the number in the lower state whose energy is  $E_{n'}$ . The absolute temperature is given by  $T$ , and  $k$  is Boltzmann's constant.

For hydrogen, the energy difference between the upper state ( $F=1, m_F=0$ ) and the lower state ( $F=0, m_F=0$ ) is so small that the ratio  $n/n'$  is greater than 0.99. That is to say, for all practical purposes, there are the same number of atoms in each state. Under these conditions the maser will not operate. The atoms in the lower state must be removed from the beam of incoming atoms (see sec. 3.5.2).

Any transition in the microwave region will have  $n/n' \approx 1$ , and so state selection will also be required in the cesium beam and rubidium gas cell.

## 3.5. THE THREE MAJOR EXAMPLES OF ATOMIC FREQUENCY STANDARDS

### 3.5.1. General Considerations

The prime emphasis of this section will be upon the relationship of the major parts of each device to the physical principles discussed in the preceding

sections. Some comment will be made on the performance characteristics of the devices, but a detailed discussion is beyond the scope of this article.

#### a. Common Functions

There are three functions that each device must perform. First, the atoms must be in the proper condition to emit EM energy (active device) or to be responsive to an external source of EM energy (passive device). Second, the atoms must be kept in interaction with the EM field long enough that the transition linewidth is acceptably narrow. (The EM field configuration must, of course, be such that an interaction with the atoms can occur.) Third, some means of detecting that transitions are occurring must be provided.

For the hydrogen, cesium, and rubidium devices, the transition frequencies are in the microwave region, and, therefore, to place the atoms in a proper condition, state selection is necessary. These ideas are discussed in Section 3.4.4.

The means by which the H, Cs, and Rb devices achieve long interaction times are clearly evident in their mechanical construction, and this construction has a strong effect on their performance characteristics.

Of the three devices, the hydrogen maser is the only active one, and the fact of its oscillation is evidence that transitions are occurring.

If we define the word particle in a general sense, then particle detection describes the means by which transitions are detected in each of the other two devices. The collection of ionized atoms, as discussed in Section 3.4.3 (item e), is the usual and obvious examples of particle detection. But, as mentioned in Section 3.2.1.d, electromagnetic energy has a particle-like as well as a wave-like character. When the frequency of the EM radiation is high enough then the radiation can be detected by means of a photocell. The radiation is collected at the detector as discrete events. That is, instead of the radiation appearing to be continuously there—as, in fact, it appears to be, at lower frequencies—it occurs in bursts. In this sense, it behaves as we normally think of particles as behaving. When the particle-like behavior of the EM field is prominent, it is common to refer to it as a photon field and to an individual event at the detector as the detection of a photon. In the rubidium gas cell, photons are detected as evidence for the occurrence of transitions.

#### b. Primary versus Secondary Standards

The ideal transition frequency of a frequency standard is that frequency which its atoms would have if they were completely removed from all surroundings including interactions with each other. This is called the free atom frequency. But, in an actual device, the atoms interact with each other, and with the rest of their environment, and the

resulting transition frequency is displaced from the free atom frequency. From both experimental and theoretical studies, some (and hopefully all) of the factors which cause significant disturbances can be identified. Furthermore, by means of experiment and theory, quantitative estimates of each disturbance can be obtained. But these estimates are just that, estimates, and there is an uncertainty associated with each of them. Those standards whose net uncertainty is the smallest—whose accuracy is highest—are often called primary standards. Those other standards whose precision (i.e., stability in time) is also high but whose accuracy is inferior are often called secondary standards.

### 3.5.2. The Hydrogen Maser

Figure 3.6(b) is a simplified schematic of the hydrogen-atom maser. It has six fundamental parts:

- (1) a vacuum envelope,
- (2) a source of hydrogen atoms,
- (3) a state selecting magnet,
- (4) a microwave cavity,
- (5) a storage bulb, and
- (6) a magnetic shield with an associated “C” field coil.

A detailed discussion of these six parts follows:

(1) In this device, as in all of the devices, the gaseous environment of the desired atoms (in this case hydrogen) must be controlled. If a hydrogen atom in the desired  $F=1, m_F=0$  state collides with a foreign atom (such as an oxygen atom), then there is a good chance that it will decay to the  $F=0, m_F=0$  state without having made the desired contribution to the field in the cavity.

(2) Hydrogen enters the source chamber in the form of  $H_2$  molecules. By means of electrodes placed across the source, the molecules are dissociated into atoms. A small-diameter, elongated hole at the top of the source collimates the atoms into a beam as they escape from the source.

(3) When the atoms leave the source they are nearly equally distributed among the 4 states shown in figure 3.6(a). The state selecting magnet removes most of the  $F=0, m_F=0$  (and  $F=1, m_F=-1$ ) atoms so that the beam entering the storage bulb is in a condition for a net emission of energy. By considering figures 3.6(a) and 3.6(b), a simple explanation of this type of state selection can be obtained.

Figure 3.6(c) shows an end view of a six-pole magnet. The beam of atoms is directed roughly along the axis of the small hole in the center of the magnet. The magnetic field intensity is zero on the axis of this hole but is of the order of several thousand gauss at the pole tips. From figure 3.6(a) it can be seen that for the states  $F=1, m_F=-1$  and  $F=0, m_F=0$ , the energy decreases with increasing  $H$ . Because of the tendency for a system to take up the lowest possible energy configuration, the atoms in these states move towards the pole tips thereby being defocused. By a similar argument,

the other states are focused. Only the  $F=1, m_F=0$  state is wanted in the storage bulb, since the other state can degrade the performance of the maser, but if  $H$  is adjusted to a few times  $10^{-2}$  ampere/meter (a few hundred microoersteds) then the effect of atoms in the wrong state can be kept to a tolerable level.

(4) Masers work on the principle of self-stimulated emission. The purpose of the cavity is to obtain a higher field intensity—and, therefore, an increased transition probability—from a small amount of input power. The input power, which is supplied by an excess of atoms in the  $F=1, m_F=0$  state, must be greater than the internal power losses. By internal losses I mean such things as escape of atoms through the entrance of the storage bulb before they have made the transition to the  $F=0, m_F=0$  state and decay to this state *without radiating* because of collisions with foreign atoms.

There is a minimum flux of atoms, in the correct state, needed in order for any given maser to oscillate. Above this level a small amount of energy is stored in the cavity in the form of EM energy in the  $TE_{011}$  mode (the cavity is a circular cylinder). A small fraction of this energy is coupled out and is the output of the maser. Its frequency is about 1420 MHz. (Actually, the usual output of the maser is at a frequency of 5 MHz and is obtained from a quartz crystal oscillator which has been phase locked to the 1420-MHz signal. Thus, the frequency stability of the 1420-MHz signal is partially transferred to the 5-MHz signal. The details of this phase locking and the purpose of using the quartz oscillator fall outside the scope of this article. (But see the discussion of item b in sec. 3.4.3.)

(5) The storage bulb is usually a hollow, thin-walled, quartz sphere about 0.15 meter (about 6 inches) in diameter. It is coated on its inside with polytetrafluoroethylene. There is a neck attached to the sphere, and the incoming flux of atoms enters through a small hole along the axis of this neck. On the average, the atoms are stored for about one second within the bulb before they chance to escape out the hole through which they entered.

This long storage time results in a very narrow linewidth for the atomic resonance. It should be said in addition, that were it not for this long storage time the maser would not oscillate—the losses would be too high. On the other hand, the bouncing of the atoms off the walls perturbs the atoms with the result that (for a bulb 0.15 meter in diameter at room temperature) the frequency incurs a fractional shift of about 2 parts in  $10^{11}$ . The fractional uncertainty in knowing this shift (see sec. 3.5.1.b) is about 2 parts in  $10^{12}$  and constitutes the biggest single factor in the inaccuracy of the H maser [8].

(6) The intensity of the earth’s magnetic field is typically about 40 ampere/meter. In addition, this field is spatially nonuniform, and the nonuniformity would prevent the maser from oscillating. The magnetic shield (there are usually three layers of

shielding) reduces the intensity and improves the uniformity of H in the region of space where the storage bulb is located. The "C" field coil produces a static field opposing that due to the residual field of the earth. The "C" field is typically adjusted to give a net H of a few times  $10^{-2}$  ampere/meter.

The magnitude of this field and, therefore, the resultant frequency shift (see item f of sec. 3.4.3.) can be measured quite accurately by taking advantage of the other two  $F=1$  energy states. This is done by equipping the cavity with a pair of Helmholtz coils which apply an audio frequency field at right angles to H. (The microwave field, in the region of the storage bulb, is parallel to H which is parallel to the axis of the cavity.) The audio frequency field (whose frequency is typically a few hundred hertz) causes transitions between the  $F=1, m=0$  level and the other two  $F=1$  levels. These transitions are detected as a decrease in the output power of the maser, and the frequency necessary to cause these transitions depends on the magnitude of H. The accuracy of this measurement is sufficiently high that the error in the maser frequency due to this source is much less than that due to the wall shift discussed above.

The uncertainties in determining the perturbations to the free H atom frequency are small enough

that the H maser is used in several of the world's laboratories as a primary standard.

### 3.5.3. The Cesium Beam

Figure 3.7 shows a schematic diagram of the cesium beam. It consists of eight major parts:

- (1) a vacuum envelope,
- (2) a source of cesium atoms,
- (3) an "A" magnet,
- (4) a microwave cavity,
- (5) a "C" field region,
- (6) a "B" magnet,
- (7) a detector, and
- (8) an external source of microwave power.

A detailed discussion of these eight parts follows:

(1) The vacuum envelope performs the same function here as it does in the H maser.

(2) Because, at room temperature, the rate of evaporation of cesium is too low, the source is a chamber which is heated to about 373 kelvin (100 degrees celsius). At this temperature, a sufficient number of cesium atoms diffuse through a small, elongated hole and are collimated as in the H maser.

(3) The purpose of the "A" magnet is to select certain atoms for exposure to the EM field. The

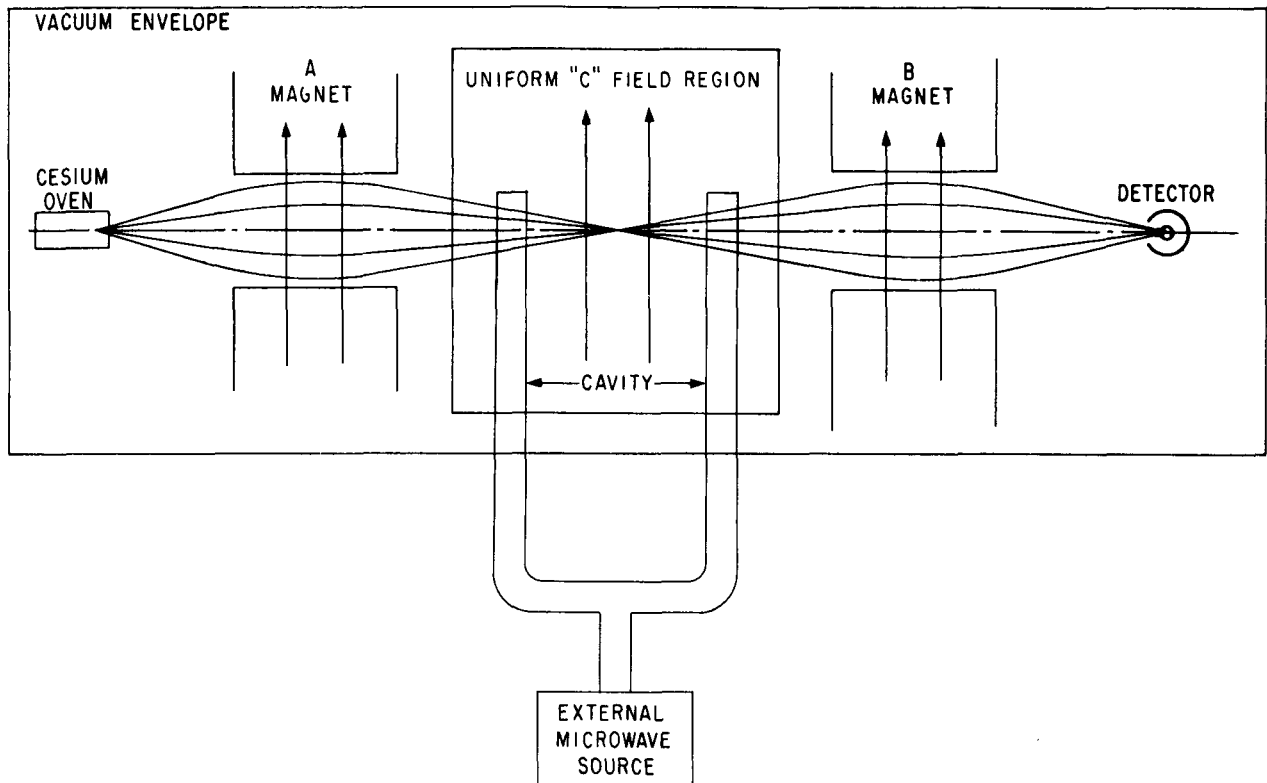

Fig. 3.7. A simplified schematic of the cesium beam.

desired atoms are those which must undergo a transition in the EM field in order that the "B" magnet later will focus them onto the detector. The basic purpose of the "A" and "B" magnets is to create a condition wherein it is possible to determine if the frequency of the microwave source is equal to the transition frequency. In the cesium beam, just as in the H maser, the two states between which transitions are to take place are essentially of equal population. Thus, the cesium beam also requires state selection but here it does not matter whether the atoms are primarily in the upper state or primarily in the lower state because  $B_{nn'} = B_{n'n}$  (see sec. 3.3.2.). (In fact, it turns out that if the state selecting magnet is of the dipolar type, atoms in both states can be used.)

(4) The cavity serves four purposes. First, it enhances the strength of the EM field for a given amount of input. This input is supplied in the form of microwave energy from an external source. Second, it results in a fairly long interaction time with the EM field. This gives the narrow linewidth which is desired. Third, it defines a definite region of interaction and fixes the direction of the EM field with respect to the "C" field. Fourth, it allows the atoms to experience only a standing-wave EM field (any running wave component could, if not transverse to the cesium atoms motion, cause a first-order Doppler shift).

Combined with a fairly large value of the interaction time  $\tau$ , the field enhancing effect of the cavity easily permits an optimum value of the product  $b\tau$  to be obtained (see sec. 3.3.2.). Figure 3.7 shows a horseshoe-shaped cavity. The beam passes first through one end of the horseshoe and then, after a time  $\tau$ , through the other. The reason for using the horseshoe cavity is that the atoms behave somewhat as if they were in a single, very large cavity. This increases the interaction time. If this scheme is to work perfectly then the EM fields at either end of the horseshoe must be exactly in phase with one another. This condition is difficult to achieve, and the failure to do it perfectly results in the largest single inaccuracy in many cesium beams.

(5) The two states between which transitions are desired are the  $F = 4, m_F = 0$  and the  $F = 3, m_F = 0$ . (To be specific, I am talking about  $\text{Cs}^{133}$  whose nuclear moment is  $7/2$ . There are actually nine  $F = 4$  states and seven  $F = 3$  states, and they all have different energies in the presence of a nonzero H (see sec. 3.4.3). These are the two states with the least dependence on H. (See item  $f$  of sec. 3.4.3.) But, just as in the H maser, the dependence is strong enough that, in the EM field region, the atoms must be shielded from the earth's field. Again, as in the H maser, a second function of the shielding is to cause the residual field of the earth to be spatially uniform in the region of interaction with the EM field. This is a particularly severe requirement here because the field must be uniform throughout the entire path of the atoms between

the two cavities. If it is not, an error is introduced which is equivalent to that due to inequality in phase between the two ends of the cavity.

(6) The "B" magnet can be identical to the "A" magnet. Its function is to focus, onto the detector, those atoms which have made a transition and to defocus those which have not.

(7) Those atoms which have made the desired transition impinge on the collector and are ionized. The detector, in laboratory cesium beams, is usually made of tungsten or a platinum-iridium alloy. When the detector is heated to about 1200 kelvin, almost all of the atoms hitting the collector are ionized.

(8) The external source of microwave energy in a cesium beam is usually supplied by a quartz crystal oscillator whose frequency has been multiplied up to the cesium transition frequency—about 9192 MHz. As in the H maser, the usual output frequency is not in the microwave region but rather at 5 MHz. The quartz oscillator takes on the long term stability of the cesium transition by being servoed to it. This is done by automatically adjusting the frequency of the external source to, in effect, maximize the number of atoms collected at the detector.

Those parameters which, in the cesium beam, alter the transition frequency from its free atom value have been thoroughly studied [9]. The uncertainties in their determination are quite small, and the cesium beam is used as a primary standard in many laboratories. The high accuracy capability resulted (in October of 1964) in the declaration of the International Committee of Weights and Measures that the physical measurement of time be based on the  $F, m_F = 4, 0 \leftrightarrow 3, 0$  transition in  $\text{Cs}^{133}$ . The world's highest quality cesium beams—such as NBS-III at the National Bureau of Standards in Boulder, Colorado; the machine at the National Research Council of Canada; and the machine at the Physikalisch-Technische Bundesanstalt in Germany—have an evaluated accuracy (one sigma) of about 5 parts in  $10^{13}$ . This is a greater proven accuracy than for any other type of device known [9].

### 3.5.4. The Rubidium Gas Cell

A schematic diagram of the rubidium gas cell is given in figure 3.8. It has five major parts:

- (1) a gas cell containing  $\text{Rb}^{87}$  gas,
- (2) a  $\text{Rb}^{87}$  light source (and associated filter) for state selection,
- (3) a microwave cavity,
- (4) an external source of microwave energy, and
- (5) a photocell detector.

A detailed discussion of these parts follows:

(1)  $\text{Rb}^{87}$  atoms at a partial pressure of about  $10^{-4}$  newtons/meter<sup>2</sup> (about  $10^{-6}$  torr) are contained in an optically transparent cell. The two levels of interest are the  $F = 2, m_F = 0$  and  $F = 1, m_F = 0$  states of the ground electronic state. ( $\text{Rb}^{87}$  has a nuclear moment of  $3/2$ , and the ground electronic state is  $^2S_{1/2}$ ; therefore, the two possible values of

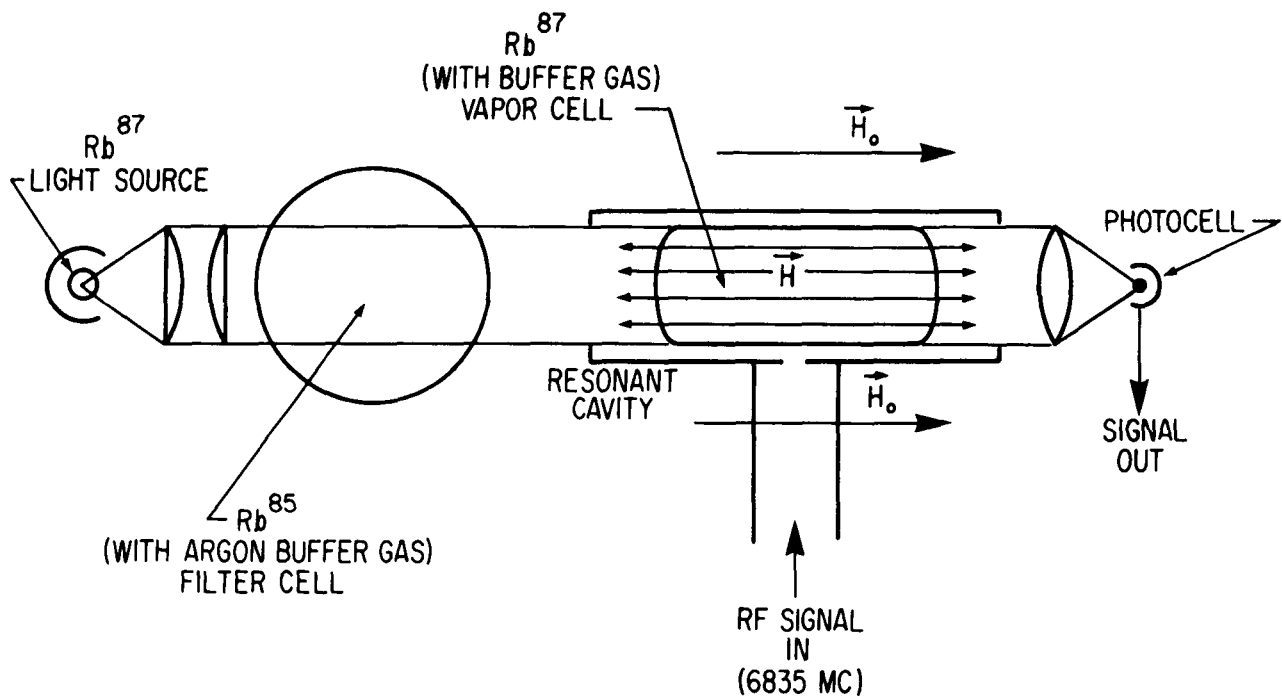

Fig. 3.8. A simplified schematic of the rubidium gas cell.

$F$  are 2 and 1.) The transition frequency is about 6835 MHz.

In addition to  $\text{Rb}^{87}$ , the cell contains a buffer gas (which is usually a mixture of neon and helium, at a partial pressure somewhere between  $1 \times 10^2$  and  $2 \times 10^4$  newtons/meter<sup>2</sup>). This buffer gas performs for the rubidium cell the same function that the storage bulb performs for the H maser and the horse-shoe cavity performs for the cesium beam: It increases, by several orders of magnitude, the interaction time with the EM field, thereby resulting in a narrower linewidth.

Unlike the H maser and the cesium beam, the atoms are used over and over again. This is possible because state selection is done within the gas cell itself.

(2) The method of state selection employed here is called optical pumping. A simplified explanation of this technique can be obtained from figure 3.9. This technique involves, in essence, three energy levels. In figure 3.9, the levels labeled B and C are, respectively, the  $F=2, m_F=0$  and the  $F=1, m_F=0$  levels between which we want transitions to occur.

Level A is a level which is energetically far removed from levels B and C. The frequency corresponding to the spacing between level A and the other two levels is about  $3.8 \times 10^{14}$  Hz. This means that almost all of the atoms will be equally distributed between states B and C, and hardly any will be in state A (see sec. 3.4.4).

Before the light is turned on, almost all of the atoms are in levels B and C. This is shown in part 1 of the figure. When the light is turned on, many of the atoms absorb energy from the light beam and are excited to level A. This is shown in part 2 of the figure. But, for atoms in state A, it is very likely they will spontaneously decay to either state B or C (see sec. 3.3.2.). Decay to states B and C is about equally probable. Part 3 of the figure shows the situation. Because the spontaneous emission probability from state B to C is very low, the net result of this pumping is that the number of atoms in state B is built up at the expense of state C. Thus, the population imbalance required so that the atoms will be responsive to the external source has been achieved. The reader should note that the rubid-

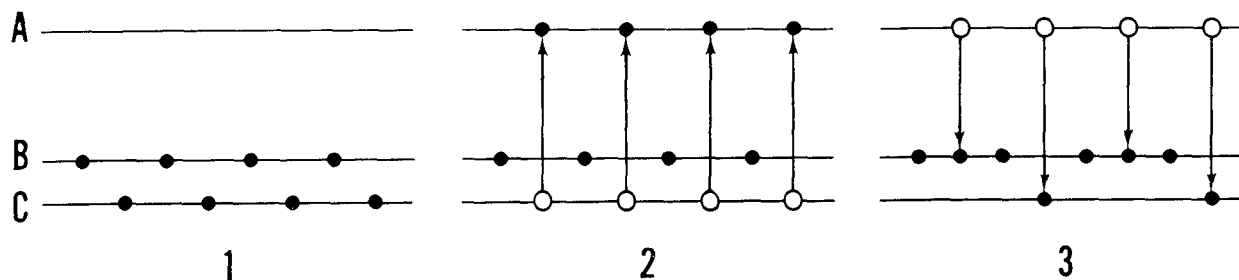

Fig. 3.9. A simplified explanation of optical pumping as applied to the rubidium gas cell. Part 1 is the condition before the pumping light is turned on. The black circles represent the fact that atoms are in certain of the possible energy states. Part 2 shows the change upon turning the pumping light on. The open circles with arrows indicate that some atoms that were in state C are now in state A. Part 3 shows the tendency of spontaneous emission to depopulate state A. It also indicates the nearly equal probability to make transitions to state B or state C.

ium cell is a passive device and that an excess population in state B is not required—an excess in state C would work just as well. The condition is as it is because of the state selecting method.

(3) The purpose of the microwave cavity is field enhancement.

(4) The external microwave energy is again supplied by a quartz oscillator and a frequency multiplier chain. If the external source is at the proper frequency, some of the atoms in state B make transitions to state C. This is detected at the photocell as a decrease in the received light. By servoing the frequency of the quartz oscillator to minimize the light at the photocell, the quartz oscillator is kept on frequency.

(5) There is a great advantage to using a photocell to detect the fact that transitions are occurring. The reason is that each photon at the light frequency has a great deal of energy, and a small change in the number of photons arriving at the detector is quite noticeable.

The buffer gas used in the gas cell causes the transition linewidth to be quite narrow because it increases the interaction time of the atoms with the EM field. Unfortunately, it also produces a very large shift in frequency, just as collisions with the Teflon coating of the storage bulb produce a net frequency shift in the H maser. The uncertainty in the determination of the shift due to the buffer gas is quite large, and, consequently, the rubidium cell serves only as a secondary standard.

### 3.6. SUMMARY

The reason for the use of atoms for frequency standards is that they have well defined energy states. In an atom which is useful as a frequency standard, the desired energy level pair is quite insensitive to the atom's environment, and, hence, the energy difference between this pair has the required high stability.

The energy level pair is used by observing transitions from one level of the pair to the other. In an active type of device—a maser—the atoms emit electromagnetic (EM) energy by making the transition from the upper to the lower of the two states. In a passive device—such as a cesium beam—an external source of EM energy causes transitions. Devices are built where the transitions are from the lower to the upper state or vice versa; in fact, devices are sometimes built where both processes are used simultaneously. Be the device active or passive, the central point is that it is the EM field which causes transitions.

There are three basic functions which any atomic frequency standard must perform. First, the atoms must be put in a condition in which they will emit EM energy (active device) or be responsive to an external source of EM energy. The most commonly used transitions are in the microwave region, and, for those transitions, state selection is required. Second, the atoms must be kept in interaction with the EM field long enough that the transition linewidth is acceptably narrow. The means by which this long interaction time is achieved in the H, Cs, and Rb devices has a detrimental side effect upon the accuracy of each of the devices. Third, some means of detecting that transitions are occurring must be provided. In the hydrogen maser, its oscillation is evidence for the occurrence of transitions. Given the broad definition of particles discussed in the text, the Cs and Rb devices sense transitions by particle detection.

For a device to adequately perform these three functions, the type of atom which is used must be carefully selected. A list of criteria for choosing an atom was given, and it was seen that several of these criteria tended to conflict. An atom whose electronic ground state is  $^2S_{1/2}$  is a good compromise in meeting these criteria, and the reasons for this were given. All of the frequency standards described in this article cause their atoms to be in a very rarified



gaseous state when interacting with the EM field. (The buffer gas in the Rb gas cell is at a fairly high pressure. This gas, however, is not the working substance; its purpose is the same as that of the Teflon coating in the hydrogen maser.) This is an important technique in achieving a stable and accurate output frequency.

In this paper, I have confined the discussion to devices which use atoms, rather than molecules, as their working substance. This was done because these usually have been the more stable and accurate devices. There is, however, at least one case—the methane saturated absorption cell—where the stability (and, perhaps, the accuracy capability) is extremely high [10]. Even though molecules are used rather than atoms, the physical basis is still a well defined energy level pair and an appropriate interaction with the EM field.

The theory of atomic structure and of the interaction of an atom with the EM field has become quite elaborate and abstract. Atomic frequency standards provide concrete examples of a great many of these ideas.

### ACKNOWLEDGEMENTS

I want to thank Dr. Donald Halford, Dr. David Wait, and Mr. Roger Beehler of the National Bureau of Standards, Boulder, for many helpful criticisms of this paper. I also wish to thank Mrs. Eddyce Helfrich for her diligent efforts in typing the manuscript.

### 3.7 REFERENCES

- [1] Holton, G., and Roller, D. H. D., *Foundations of Modern Physical Science*, p. 615 (Addison-Wesley Publishing Co., Inc., Reading, MA, 1958).
- [2] *Ibid.*, p. 581.
- [3] *Ibid.*, p. 591.
- [4] Oldenberg, O., *Introduction to Atomic Physics*, p. 335 (McGraw-Hill Book Co., Inc., New York, NY, 1949).
- [5] Holton, *op. cit.*, p. 651.

- [6] Persico, E., *Fundamentals of Quantum Mechanics*, translated by G. M. Temmer, p. 454 (Prentice-Hall, Inc., New York, NY, 1950).
- [7] Cutler, L. S., and Searle, C. L., "Some aspects of the theory and measurement of frequency fluctuations in frequency standards," *Proc. IEEE*, **54**, No. 2, pp. 136-154 (February 1966).
- [8] Hellwig, H., Vessot, R. F. C., Levine, M. W., Zitzewitz, P. W., Allan, D. W., and Glaze, D. J., "Measurement of the unperturbed hydrogen hyperfine transition frequency," *IEEE Trans. on Instrum. and Meas.*, **IM-19**, No. 4, pp. 200-209 (November 1970).
- [9] Beehler, R. E., Mockler, R. C., and Richardson, J. M., "Cesium beam atomic time and frequency standards," *Metrologia*, **1**, No. 3, pp. 114-131 (July 1965).
- [10] Barger, R. L., and Hall, J. L., "Use of laser-saturated absorption of methane for laser frequency stabilization," *Proc. of the 23rd Ann. Symp. on Frequency Control* (U.S. Army Electronics Command, Ft. Monmouth, NJ 07703, May 6-9, 1969), p. 306 (NTIS, AD 746209, 1969).

### 3.8 BIBLIOGRAPHY

#### Background

- [B1] Holton, G., and Roller, D. H. D., *Foundations of Modern Physical Science* (Addison-Wesley Publishing Co., Inc., Reading, MA, 1958).
- [B2] Oldenberg, O., *Introduction to Atomic Physics* (McGraw-Hill Book Co., Inc., New York, NY, 1949).
- [B3] Persico, E., *Fundamentals of Quantum Mechanics*, translated by G. M. Temmer (Prentice-Hall, Inc., New York, NY, 1950).
- [B4] Ramsey, N. F., *Molecular Beams* (Oxford University Press, Amen House, London E.C.4, 1956).
- [B5] Herzberg, G., *Atomic Spectra and Atomic Structure*, translated by J. W. T. Spinks (Dover Publications, New York, NY, 1944).

#### Devices

- [B6] Kleppner, D., Goldenberg, H., and Ramsey, N. F., "Theory of the hydrogen maser," *Phys. Rev.*, **126**, No. 2, pp. 603-615 (April 1963).
- [B7] Beehler, R. E., Mockler, R. C., and Richardson, J. M., "Cesium beam atomic time and frequency standards," *Metrologia*, **1**, No. 3, pp. 114-131 (July 1965).
- [B8] McCoubrey, A. O., "A survey of atomic frequency standards," *Proc. IEEE*, **54**, No. 2, pp. 116-135 (February 1966).
- [B9] Hellwig, H., "Areas of promise for the development of future primary frequency standards," *Metrologia*, **6**, No. 4, pp. 118-126 (October 1970). (See chap 6).

**CHAPTER 4 – PART A**  
**A HISTORICAL REVIEW OF ATOMIC FREQUENCY STANDARDS**

**Roger E. Beehler †**

**Contents**

	<i>Page</i>
4A.1. Introduction.....	87
4A.2. Development of Basic Techniques.....	87
4A.2.1. Atomic Beam and Magnetic Resonance Techniques.....	87
4A.2.2. Optical Pumping Techniques .....	89
4A.2.3. Buffer Gas Techniques.....	91
4A.2.4. Storage Techniques for Increasing Interaction Times.....	91
4A.2.5. Maser Techniques.....	92
4A.3. Application of Basic Techniques to the Development of Specific Types of Atomic Frequency Standards.....	93
4A.3.1. Development of the World’s First “Atomic Clock” .....	93
4A.3.2. Development of Atomic Beam Standards Utilizing Cesium or Thallium.....	93
4A.3.3. Development of Practical Gas Cell Frequency Standards.....	96
4A.3.4. Development of the Atomic Hydrogen Maser.....	97
4A.4. Conclusions.....	99
4A.5. References .....	99

---

†Time and Frequency Division, Institute for Basic Standards, National Bureau of Standards, Boulder, Colorado 80302. (Written when author was with Frequency and Time Division, Hewlett-Packard Company, Palo Alto, CA.)

"A thing is not brought to perfection at once from the outset but through  
an orderly succession of time . . ."  
St. Thomas Aquinas, I. 279

An attempt is made to trace the historical development of the leading contenders in the atomic frequency standards field—cesium and thallium atomic beam devices, rubidium gas cell standard, and the hydrogen maser. Many of the important experiments leading to the development of techniques basic to the various types of standards, such as the magnetic resonance method, optical pumping, buffer gases and wall coatings, and maser techniques are briefly described. Finally, the application of these basic techniques to the development of the specific types of atomic standards is discussed.

**Key words:** Ammonia clock; atom storage techniques; atomic clock; atomic frequency standard; buffer gases; cesium beam; gas cells; ground states; hydrogen maser; magnetic resonance; optical pumping; storage bulbs; thallium beam; wall shift.

## 4A.1. INTRODUCTION

ALTHOUGH the exploitation of atomic frequency standards on a large scale dates back to less than 10 years ago when they came into general use as basic reference standards in many laboratories, some of the basic techniques involved had been developed almost fifty years ago. It is the purpose of this paper to review some of the early experiments and outline the subsequent development of basic techniques which have led to the present atomic frequency standards. The discussion will be confined to those standards which are presently available commercially to the general user or are at least under active development by several commercial or national standards laboratories—namely, cesium and thallium atomic beam devices, rubidium gas cell devices, and hydrogen masers. Because of the scope of the subject, it will often be impossible to include many details of the principles of operation of equipment, measurement procedures, and general performance results. However, an attempt will be made to give adequate references in all cases. The historical development of the most important *basic* techniques will first be described without regard to specific frequency standards, followed by a discussion of the later application of these basic techniques to the development of specific types of atomic standards. For an analysis of the relative merits of the different types of atomic standards discussed here and for an up-to-date status report of their performance achievements reference is made to the article by A. McCoubrey in this issue [1].

## 4A.2. DEVELOPMENT OF BASIC TECHNIQUES

### 4A.2.1. Atomic Beam and Magnetic Resonance Techniques

The first experiments using atomic or molecular beams were those of the French physicist A. L. Dunoyer in 1911 [2]. Dunoyer's apparatus, shown schematically in Fig. 1, consisted simply of a 20-cm-long glass tube with three separately evacuated chambers which served as source, collimation, and observation chambers. He observed that when sodium was heated sufficiently in *A*, a deposit was formed in *C* whose distribution could be explained by the assumption that the sodium atoms traveled in straight lines.

Nine years later at the University of Frankfurt in Germany, Otto Stern became the first to use a molecular beam technique for making physical measurements. In these experiments to measure directly the speed of gas molecules, a source of silver atoms at the center of an evacuated jar produced a beam of atoms which was collimated by a narrow slit and detected by deposition on a glass plate near the jar's surface. The principal parts were mounted such that they could be rotated about a vertical axis inside the bell jar at speeds of 1500 rpm. Stern observed, in agreement with the results of Dunoyer's experiments, a narrow sharp deposit explainable by straight line atomic trajectories as long as the apparatus was stationary. However, for rotational speeds of 1500 rpm the deposited pattern was shifted slightly and also appeared fuzzy. From the amount of the shift Stern could calculate the average velocity of the atoms, which

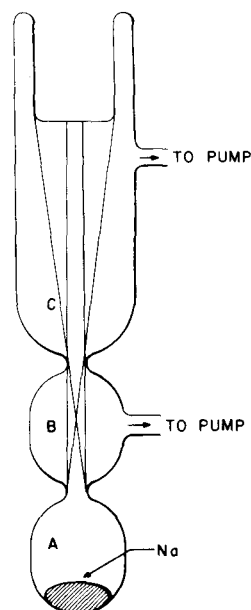

Fig. 1. Schematic diagram of Dunoyer's original atomic beam apparatus [2].

turned out to agree with the predictions of kinetic theory to within a few percent. The fuzziness of the deposit showed that a distribution of speeds existed in the beam.

Less than two more years elapsed before Stern and a colleague, Walther Gerlach, performed their celebrated "Stern-Gerlach experiment" [3] which was to have a most profound effect on the development not only of molecular beam techniques but also of quantum mechanics in general. The results of this experiment supported the concept of spatial quantization—i.e., the seemingly unlikely idea that the magnetic moment of an atom in an external magnetic field can have only a few possible discrete orientation angles with respect to the external field lines. If the atom is considered to behave as a small bar magnet of magnetic moment  $\mu$  in an external field,  $H$ , its change in energy, when placed in the field, would be given by  $\Delta E = \mu H \cos \theta$ , where  $\theta$  is the angle between the magnet and the field lines. Until the performance of the Stern-Gerlach experiment, it was generally believed that a large number of such atoms in a field would show a random distribution of the angle  $\theta$ , and hence would have energy values anywhere between  $+\mu H$  and  $-\mu H$ . An opposing view, however, was suggested by observations made as early as 1896 by the Dutch physicist Pieter Zeeman that certain spectral lines split into two or more sharp lines when the radiating atom is placed in an external magnetic field. This effect could be explained by postulating that the energy of atoms in a magnetic field is quantized, resulting in the observed spectral emission lines produced by transitions between these discrete energy levels being limited to a few sharply defined frequencies through the relation  $E_1 - E_2 = h\nu$ , where  $E_1$  and  $E_2$  are the energies of the two levels involved in the transition,  $h$  is Planck's constant, and  $\nu$  is the frequency of the emitted spectral line. If the atoms could have random orientations, and hence energies, in the field, one would expect to observe a blurred spectral line corresponding to a spread in energy of the levels of  $2\mu H$ , contrary to the experimental evidence.

In 1921 Stern conceived an experiment for testing for space quantization using a beam of silver atoms. He realized that the force exerted on a silver atom with magnetic moment  $\mu$  by a magnet designed to produce a field with a large gradient  $\partial H/\partial z$  across the gap would be given by  $-\mu(\partial H/\partial z) \cos \theta$  and would thus vary continuously from  $+\mu(\partial H/\partial z)$  to  $-\mu(\partial H/\partial z)$  if atoms were oriented randomly. On the other hand, if space quantization existed, the force on silver atoms would be either  $-\mu(\partial H/\partial z)$  or  $+\mu(\partial H/\partial z)$ . By shooting a beam of silver atoms between the poles of such a magnet and observing the deflection pattern produced, one should observe either a single broad fuzzy line (if random orientations are possible) or two discrete sharp lines (if space quantization exists). Performing the experiment with Gerlach, who had a magnet of the proper design, Stern did indeed observe two separated lines in the deflection pattern.<sup>1</sup> As we shall see shortly,

<sup>1</sup> Because the existence of electron spin with its effect on effective magnetic moments was not yet known in 1921, Stern actually expected to observe three discrete lines instead of two. Thus, while this experiment supported the concept of space quantization an additional mystery was introduced which was not resolved until 1925.

magnets similar to that used in the Stern-Gerlach experiment are a basic component of today's atomic beam frequency standards, being useful for obtaining a beam of atoms in a specific energy state.

In 1923 Stern became head of the Department of Physical Chemistry at the University of Hamburg. During the next 10-year period he and his students published a series of some 30 papers which served to establish many of the basic principles and techniques used in today's atomic beam devices. Particular emphasis was placed upon the development of atomic beam methods for greatly improved measurements of magnetic moments.

In 1932 O. Frisch and E. Segrè used an atomic beam technique with potassium to detect transitions produced by subjecting the atoms to a sudden variation in the direction of a static magnetic field located between two Stern-Gerlach magnets [4]. The first magnet acted as a polarizer, separating the atomic beam into two beams differing in magnetic state. One of these beams was then blocked by the obstruction of part of the magnet gap, producing a beam with atoms only in the desired state. These remaining atoms were then passed through a second Stern-Gerlach magnet which acted as an analyzer to detect whether the magnetic state had been changed in the region between the magnets. When the static field with its rapid reversal in direction was applied in the center region, a change was noted in the number of atoms reaching the atomic beam detector located after the second magnet. This indicated that some of the atoms had made transitions to different energy states (and thus had their magnetic moment reversed in direction), producing a change in their deflection by the second magnet. This apparatus, used some 35 years ago, differed primarily from present atomic beam tubes only in the method of producing the transitions between the atomic energy levels.

Six years later in 1938 at Columbia University, I. I. Rabi, one of Otto Stern's former students, made the next major advance in atomic beam techniques by developing his magnetic resonance method, which permitted the detection of transitions between the closely spaced energy levels resulting from the interaction of an external magnetic field with an atom or molecule [5]. Rabi's apparatus, shown schematically in Fig. 2, was similar to that used by Frisch and Segrè, except that transitions between the magnetic states of an atom or molecule were produced by applying an oscillating RF field of proper magnitude and direction and whose frequency satisfied the resonance condition,  $W_1 - W_2 = h\nu$ , for the two energy levels of interest.

Although the field directions in the *A* and *B* Stern-Gerlach magnets were the same, the field gradients were arranged to be in opposite directions, so that, in the absence of transitions in the *C* region, molecules from the source *O* would undergo equal and opposite deflections by the two magnets and therefore strike the detector *D*. Application of the proper frequency RF field in the region *R*, however, produced a change from one energy state to another, such that the resultant change in magnetic moment produced a sufficiently different deflection in the *B* magnet to cause the molecule to miss the detector. The surface-ionization type

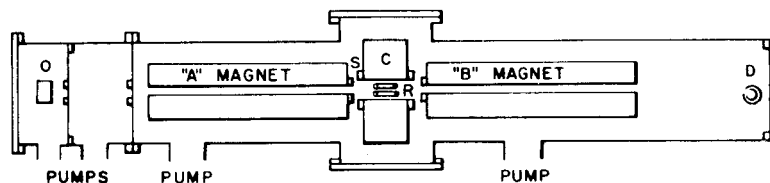

Fig. 2. Schematic diagram of Rabi's magnetic resonance apparatus [5].

detector used by Rabi ionized nearly all of the molecules striking the 0.001-inch wide surface and thus produced an electrical signal proportional to the number of molecules striking the wire per second. As the excitation frequency was varied through the resonance value for a particular transition between two energy states, Rabi observed a sharp decrease in the detector output signal.<sup>2</sup> The first resonance curve ever observed by this magnetic resonance technique is shown in Fig. 3. It was published by Rabi and his colleagues in February, 1938, and represents a resonance between two spatial quantization states of the lithium nucleus obtained with a beam of LiCl molecules in a strong enough *C* field to decouple completely the nuclear magnetic moments from one another and from the molecular rotation [5]. From the measured values of the frequency at resonance and the static *C* field in which the transition occurred, Rabi was able to calculate much improved values for several nuclear magnetic moments.

Soon thereafter another member of the Columbia group, P. Kusch, extended the new atomic beam magnetic resonance technique to measurements of separations of the closely spaced hyperfine structure levels in the ground state of atoms [6]. Hyperfine-structure level separations in several isotopes of lithium and potassium were measured to a precision of 0.005 percent. Relative to earlier hyperfine-structure measurements by optical means, the atomic beam magnetic resonance results were simpler to interpret, much more accurate, and of much higher resolution.

A further refinement in the atomic beam magnetic resonance technique, which proved to be of extreme importance in the application of the technique to frequency standards, was introduced by N. F. Ramsey at Harvard University in 1950 [7]. In the conventional atomic beam apparatus at that time the oscillating RF field for producing transitions in the beam was applied over a relatively short region, being limited by the requirements of maintaining uniform phase and uniform static magnetic field (*C* field) over the entire region of interaction between the atoms and the RF field. A lengthened interaction region is desirable for many experiments, however, because the longer the interaction time, the more sharply defined are the atomic energy levels and thus also the resonance frequencies associated with transitions among them. Ramsey developed a method which increased the effective interaction time without adversely

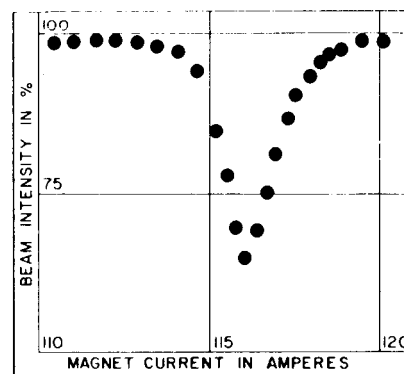

Fig. 3. First published resonance curve using Rabi's magnetic resonance technique [5].

affecting the phase and field uniformity requirements. He replaced the usual single oscillating field region with two such regions separated by a relatively large distance and showed that the effective interaction time was now the entire length separating the two RF regions. Moreover, the observed resonance width under these conditions is 40 percent less than that for a single Rabi-type excitation of length equal to the separation of the two Ramsey fields and the *C* field uniformity requirements are actually less severe for the Ramsey case. Application of this technique to atomic beam frequency standards has resulted in resonance linewidths of less than 50 Hz at 9192 MHz.

Before discussing the specific development of cesium and thallium atomic beam frequency standards based upon the basic techniques described up to this point, let us first consider the historical evolution of some other methods and techniques which led to other types of atomic standards, such as the optically pumped gas cell devices and the hydrogen maser.

#### 4A.2.2. Optical Pumping Techniques

Optically pumped gas cell frequency standards, such as the Rb<sup>87</sup> gas cell devices currently available commercially, represent a completely different approach to the problem of detecting a condition of resonance in the hyperfine structure levels of the ground state of an atom. In the atomic beam devices, as we have seen, the occurrence of transitions excited by RF resonance radiation is detected by observing resultant changes in the trajectories of the atoms comprising the beam. In gas cell devices, on the other hand, a double resonance technique is used in which the RF resonance

<sup>2</sup> In the early experiments described here the transition frequencies of interest depended linearly on the magnitude of the static magnetic field provided in the *C* region. For reasons of experimental convenience resonance curves were actually obtained by keeping the frequency fixed and sweeping the field through the corresponding resonance value.

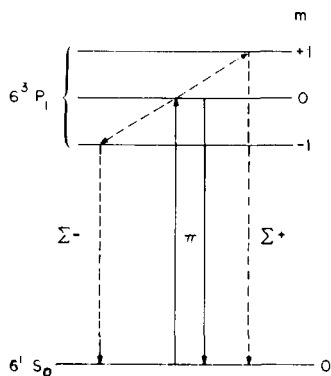

Fig. 4. Simplified energy level diagram for mercury showing states used in early double resonance experiments [12].

condition is detected by the resultant changes in the intensity of transmitted optical radiation at the proper frequency to produce transitions between the ground and first excited states of the atom.

The development of the optical pumping and double resonance techniques, which are basic to the operation of gas cell standards, can be traced back to 1949 when Prof. F. Bitter at the Massachusetts Institute of Technology showed that the frequency, intensity, and polarization of optical radiation emitted by an atom in a  $^2P \rightarrow ^2S$  (ground state) transition are all altered if the atom is simultaneously subjected to a weak oscillating RF field whose frequency is near resonance for the hyperfine levels of one of the energy states involved in the optical radiation process [8]. About this same time A. Kastler and J. Brossel of the Ecole Normale Supérieure in Paris suggested a double resonance technique as a sensitive means of gaining information about the structure of energy levels [9]. The first application of this technique was to one of the excited states of the mercury atom by Brossel and Bitter in 1950 [10].

As an aid to understanding the way in which the double resonance technique was first used, consider the simplified energy level diagram for mercury shown in Fig. 4. The levels indicated are the  $6^1S_0$  ground state and the three Zeeman levels of the  $6^3P_1$  excited state. If mercury vapor is illuminated by optical resonance radiation at  $2537 \text{ \AA}$ , transitions will occur from the ground state to one of the excited-state levels, the particular one depending on the polarization of the radiation. In the experiment of Brossel and Bitter a polarization (labeled  $\pi$  in Fig. 4) was used which selectively populated the  $m=0$  level of the triplet. Under these circumstances the emitted light from spontaneous transitions back to the ground state also contains only  $\pi$  radiation. If now an RF field is applied perpendicular to the static magnetic field producing the Zeeman splitting and its frequency is adjusted to the proper value for resonance between the  $m=0$  and the  $m=\pm 1$  levels, transitions will be induced to the  $m=\pm 1$  states. Decay from these levels back to the ground state will now cause  $\Sigma$  components to appear in the emitted light. Since the intensity and polarization of the emitted light are thus altered in the process, a means is available for optically detecting the occurrence of the RF resonance. A set of RF resonance curves for mercury ob-

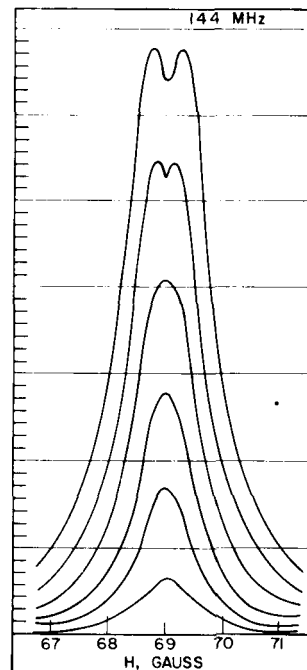

Fig. 5. Set of RF resonance curves obtained with double resonance technique for mercury [10].

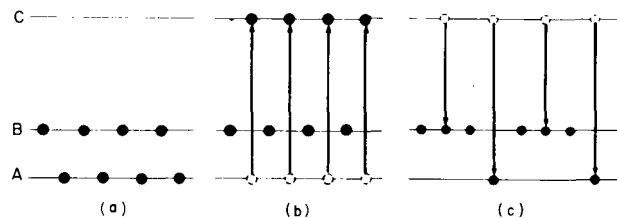

Fig. 6. Simplified optical pumping method.

tained in this manner by Brossel and Bitter is shown in Fig. 5. Each curve corresponds to a different amplitude of the RF field.

The development of the method of optical pumping as applied to the building up of the population of one certain level at the expense of others in the ground state of atoms is due primarily to Kastler [11], [12]. Consider the much simplified energy level diagram shown in Fig. 6, where  $A$  and  $B$  represent two closely-spaced energy states in the hyperfine structure of the ground state of an atom and  $C$  represents one of the levels of the first excited state. Transitions  $A \rightarrow C$  and  $B \rightarrow C$  occur at optical excitation frequencies, while transitions  $A \leftrightarrow B$  are in the RF range. Before application of any excitation radiation to the system, atoms are equally distributed between levels  $A$  and  $B$  of the ground state as in Fig. 6(a). If optical resonance radiation from which the  $B \rightarrow C$  component has been removed by some means such as filtering is now used to illuminate the system, atoms in level  $A$  absorb an optical photon and make transitions to  $C$ , as indicated in Fig. 6(b). Since lifetimes in the excited state are very short, however, the atoms in  $C$  sponta-

neously re-emit a photon and fall either to level *A* or *B* with approximately equal probabilities. As shown in Fig. 6(c), the net effect at this point has been to increase the population of *B* at the expense of *A*. Now, since there are still atoms in *A* which can be excited to *C* by the optical resonance radiation, the cycle is repeated until (ideally) all the atoms end up in level *B*. This is then the process of optical pumping for changing the population distribution among the ground state levels.

If an RF excitation is now applied which is adjusted in frequency to the resonance value corresponding to the frequency separation of *A* and *B*, the pumped atoms in *B* will be stimulated to make transitions back to *A*, at which point the optical pumping process resumes. In 1956 H. G. Dehmelt at the University of Washington developed the technique of monitoring the intensity of the light transmitted through the sample as a means of detecting the occurrence of the RF transitions [13]. Using a photocoell detector, one observes an output current which increases to a constant maximum value (maximum transparency of the sample) for the condition in Fig. 6(c), since at that point no atoms are available to be pumped *A*→*C* by absorbing part of the incident light. As the RF signal is swept through resonance, however, atoms transfer to *A* where optical absorption again takes place, producing a sharp drop in the transmitted light. The detection of RF resonances by this means is extremely sensitive. For example, a sample of vapor at a pressure of only  $10^{-7}$  torr can reduce the intensity of the transmitted light by 20 percent when the correct RF is applied. A very large effective energy gain occurs with the optical detection technique, since the optical photon detected has an energy approximately  $10^4$  to  $10^5$  times greater than the energy of the RF photon involved in the microwave transition. As we shall see in more detail later, the use of optical pumping and optical detection with atomic systems of  $\text{Na}^{23}$ ,  $\text{Cs}^{133}$ , and  $\text{Rb}^{87}$  has made possible the development of extremely compact atomic frequency standards relative to the atomic beam devices.

#### 4A.2.3. Buffer Gas Techniques

While the optical pumping technique as briefly described in the preceding section will, in principle, produce a large population buildup in level *B* of Fig. 6, collisions of atoms in the sample with each other and with the walls of the containing vessel actually provide a relaxation mechanism whereby atoms can "leak" back to level *A* without the application of RF. Even in very dilute samples atoms make about 10 000 collisions per second with the walls. Since this is usually greater than the number of optical photons which the atom can absorb per second for repumping to level *B*, the pump effectively becomes very leaky and at best only weak RF resonances can be observed.

In 1955 in the laboratory of A. Kastler a fortunate accident occurred during some experiments with sodium vapor in highly-evacuated glass bulbs which was to provide the key for significantly improving the efficiency of the optical pumping process. When a vacuum system failure allowed

hydrogen gas to be introduced into one of his sodium bulbs, Kastler and his colleagues were amazed to find that the optical pumping was greatly increased! The foreign gas introduced was found to act as a buffer between the sodium atoms and the walls where disorienting collisions take place. It was found in later experiments that, because of collisions between atoms of the sample and those of the buffer gas, the average diffusion time to the walls could be increased from  $10^{-4}$  second (without buffer gas) to nearly a second. It is, of course, necessary to use a buffer gas which does not itself disorient the sample atom's magnetic state during collisions. In general, use of sample atoms in a  $^2S_{1/2}$  ground state with its spherical symmetry appears to be the best way to insure minimum interaction during buffer gas collisions.

In addition to producing an enhancement of the optical pumping process by increasing the effective time during which RF transitions can be excited, the use of buffer gases also causes a reduction in the observed resonance linewidth as compared to the normally observed Doppler broadened value. This "collision-narrowing" effect in a buffer gas was first predicted by R. H. Dicke in 1953 [14] and was observed experimentally by J. Wittke and Dicke at Princeton University in 1954 [15]. Measuring the hyperfine splitting in the ground state of atomic hydrogen by a microwave absorption technique, they found that atomic hydrogen at a pressure of  $5 \times 10^{-4}$  torr in a buffer gas of clean molecular hydrogen at 0.2 torr produced a resonance width of only 3 kHz or one-sixth of the normal Doppler width.

In 1956 H. G. Dehmelt performed optical pumping experiments with sodium in argon buffer gas and observed relaxation times of up to 0.21 second which corresponds to an amazing  $10^8$  sodium-argon collisions occurring before disorientation of the sodium atom [13]. Dehmelt pointed out at that time that such long relaxation times (0.21 second) used in future RF resonance experiments with optical pumping would provide extremely narrow linewidths. Even longer relaxation times (up to 2 seconds) were obtained by Dehmelt's group by replacing the buffer gas with a solid buffer wall coating chosen to have minimum magnetic interaction with colliding rubidium atoms [16]. Using eicosane ( $\text{C}_{20}\text{H}_{42}$ ), they obtained strong resonances in rubidium and found that at least 600 collisions occurred before appreciable disorientation. W. Hawkins, working at Yale University, also obtained favorable results with wall surfaces of absorbed air molecules on Apiezon L grease and on copper [17]. Several years later, however, during the early development phase of commercial gas cell standards, R. M. Whitehorn at Varian Associates concluded that use of solid buffer coatings for commercial applications presented too many technical problems [18]. To date, all commercial gas cell standards have used buffer gases.

#### 4A.2.4. Storage Techniques for Increasing Interaction Times

The advantages to be gained in terms of narrower resonance lines by increasing the interaction time between an atomic beam and the applied RF resonance radiation have already been mentioned briefly in connection with the de-



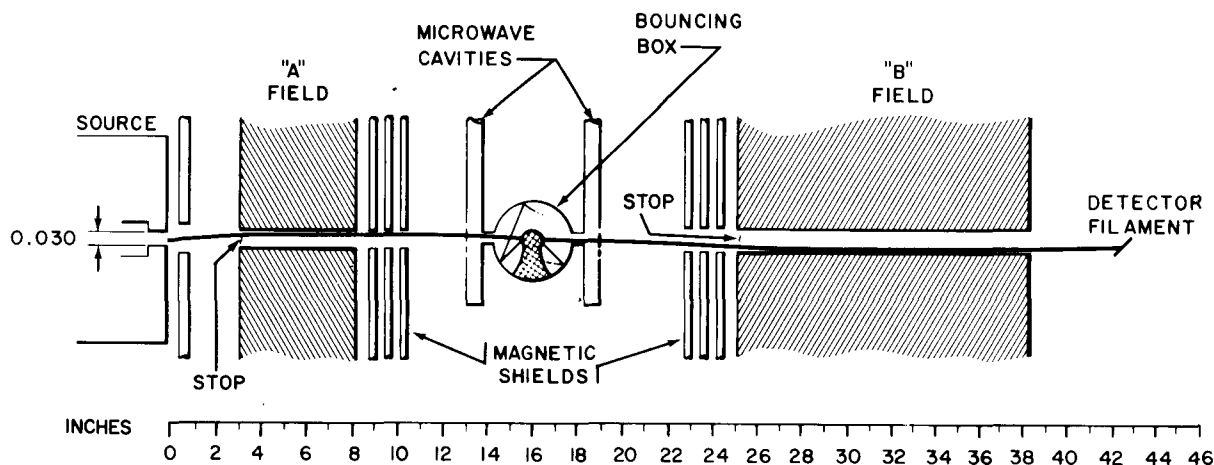

Fig. 7. Schematic diagram of "broken-beam" apparatus [21].

velopment of Ramsey's separated oscillating fields technique. In 1957 Ramsey pointed out that it should be possible to further increase the interaction time in such an experiment by "storing" the atoms in a bounce box having a suitable non-disorienting wall coating and located between the two RF field regions of an atomic beam apparatus [19]. If the collisions with the walls of the bounce box do not appreciably affect the magnetic state of the atom, an effective increase in the separation of the two fields is realized without physically lengthening the apparatus.

Kleppner, Ramsey, and Fjelstadt reported in 1958 the first successful results using this "broken-beam" technique [20]. The bounce box was designed so that an atom had to make at least two collisions in order to pass through and contribute to an observed resonance. Employing a beam of atomic cesium, they were able to observe resonances between the hyperfine states for wall coatings of teflon heated to 100°C, eicosane, and polyethylene. The authors at this time stated their intention to test other substances for wall coatings for application in a "high-precision atomic clock incorporating both the storage box and maser principles."

Further experiments with a cesium beam and a variety of wall coatings, using the apparatus shown schematically in Fig. 7, were reported in 1961 by Goldenberg, Kleppner, and Ramsey [21]. For storage bulbs coated with "Paraffint" (a mixture of long chain paraffins), resonance widths of only 150 Hz were obtained as compared with 2 kHz without the storage bulb. This result implied that at least 200 collisions could occur before relaxation of the hyperfine states became a problem. One unfavorable feature of the experimental observations was a rather large shift of several hundred Hz in the resonance frequency resulting from slight displacements of the energy levels during each collision process. This type of shift was minimized later in the hydrogen maser applications because of the much lower polarizability of the hydrogen atom compared to cesium.

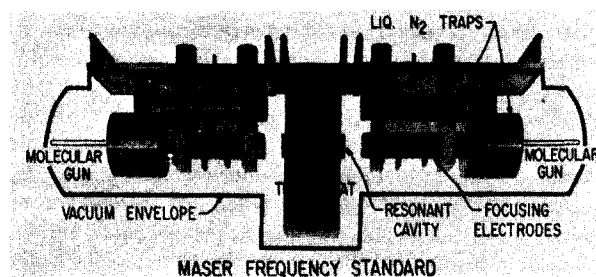

Fig. 8. Diagram of an early ammonia beam maser showing arrangement of components (courtesy of National Bureau of Standards, Boulder, Colo.).

#### 4A.2.5. Maser Techniques

The development of maser techniques in 1953, initially using ammonia, represented still another approach to the problem of using microwave resonances in atoms or molecules as frequency standards. The maser was invented by C. H. Townes of Columbia University [22] but was also proposed independently by N. G. Basov and A. M. Prokhorov of the U.S.S.R. [23]. In this device, a collimated beam of ammonia molecules effuses from a source and then passes through an inhomogeneous electrostatic field designed to spatially separate the two energy states of the inversion spectrum, just as a Stern-Gerlach magnet separates magnetic states of atoms in the magnetic resonance method. The electrostatic state separator applies a radially outward force to molecules in the lower inversion state, but a radially inward force on the upper energy state molecules. The upper-state molecules are thus focused into a high- $Q$  cylindrical microwave cavity tuned to the resonance frequency for the ammonia inversion transition ( $J=3, K=3$ ) at 23 870 MHz. The resulting large excess population of upper energy state molecules in the cavity is then favorable for stimulated transitions from upper to lower inversion

states with an accompanying emission of an RF photon.

Townes was able to get a sufficient flux of molecules into the cavity so that the emitted microwave energy exceeded the losses involved, and a small amount of excess energy could be coupled out of the cavity for external use. Operation of the maser in this manner as an oscillator was found to require a flux of at least  $5 \times 10^{12}$  molecules per second per square centimeter. Figure 8 shows the physical arrangement of the components in an ammonia maser, modified for operation with two beams to reduce Doppler effects.

Following the first successful operation of a maser in 1953, J. P. Gordon, H. J. Zeiger, and Townes studied in detail the characteristics of the maser oscillation frequency and found rather strong dependencies of the output frequency upon the ammonia source pressure and the voltage applied to the electrostatic focuser [24]. The strong coupling between the ammonia beam and the resonant cavity also causes the output frequency to depend significantly on the tuning of the cavity.

In spite of intensive research efforts in the United States, the U.S.S.R., Japan, Switzerland, and several other countries during the next few years to develop adequate techniques for controlling the critical maser parameters and for achieving a reproducible frequency from one maser to another, it has now become apparent that, except possibly for its high short-term frequency stability, the ammonia maser cannot compete with other types of atomic devices for use as a primary or secondary frequency standard. Its importance is mainly that it led to the development of one of the present-day leading contenders for the best atomic frequency standard—the hydrogen maser.

### 4A.3. APPLICATION OF BASIC TECHNIQUES TO THE DEVELOPMENT OF SPECIFIC TYPES OF ATOMIC FREQUENCY STANDARDS

#### 4A.3.1. Development of the World's First "Atomic Clock"

The first operational complete "atomic clock" system was developed at the National Bureau of Standards (NBS), Washington, D. C., in 1948–1949 by H. Lyons and his associates [25]. This system consisted basically of a quartz crystal oscillator, electronically stabilized by the  $J=3, K=3$  absorption line in ammonia at 23 870 MHz, together with suitable frequency dividers for driving a 50-Hz clock from the stabilized oscillator. This historic accomplishment was the culmination of many years of experimental interest in the absorption spectrum of ammonia, extending back to 1933 and the remarkable experiments of C. E. Cleeton and N. H. Williams in which they were able to observe absorption lines in ammonia more than 10 years before the development of most microwave equipment and techniques [26]. Aided by the rapid development of microwave techniques for radar applications during World War II, B. Bleaney and R. P. Fenrose succeeded in observing the rotational fine structure of ammonia in 1946 [27]. About this time R. V. Pound proposed stabilizing a klystron with one of the

ammonia spectral lines [28]. This was accomplished by W. V. Smith et al. in 1947 [29] and shortly thereafter by W. D. Hershberger and L. E. Norton at RCA [30].

The NBS system, developed specifically for use as a frequency standard, was first operated on August 12, 1948. A photograph of this first "atomic clock" is shown in Fig. 9. The heart of the system, a 25-foot long waveguide absorption cell filled with ammonia at a pressure of 10–15 microns, is shown wrapped around the clock mounted on top of the equipment cabinets. The  $J=3, K=3$  absorption line obtained by sweeping the excitation frequency through the molecular resonance can be seen displayed on the oscilloscope in the photograph. A block diagram of the complete atomic clock system (in a somewhat modified form from

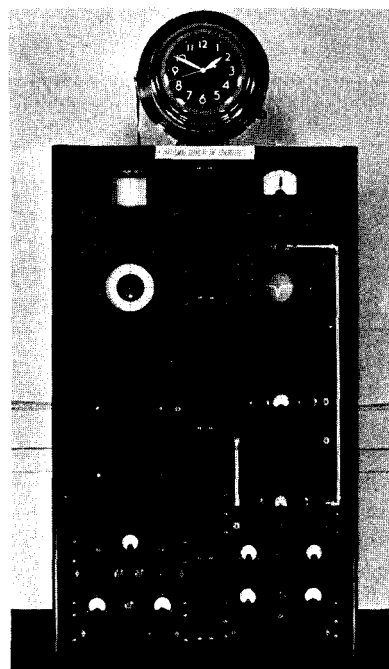

Fig. 9. Original NBS ammonia clock (courtesy of National Bureau of Standards, Boulder, Colo.).

that shown in Fig. 9) is presented in Fig. 10. Two versions of the NBS ammonia clock were built with demonstrated long-term stabilities of  $1 \times 10^{-7}$  and  $2 \times 10^{-8}$ . Work on a third version was eventually halted when it became apparent that atomic beam techniques offered more promise for frequency standard development.

#### 4A.3.2. Development of Atomic Beam Standards Utilizing Cesium or Thallium

According to Hershberger and Norton [30], I. I. Rabi made the specific suggestion of using atomic or molecular transitions in an atomic clock in his January, 1945 Richtmyer lecture before the American Physical Society. Four and one-half years later a program was initiated at the National Bureau of Standards to develop an atomic beam frequency standard utilizing cesium, which would hopefully avoid the problems of collision and Doppler broadening encountered in the ammonia absorption cell work.

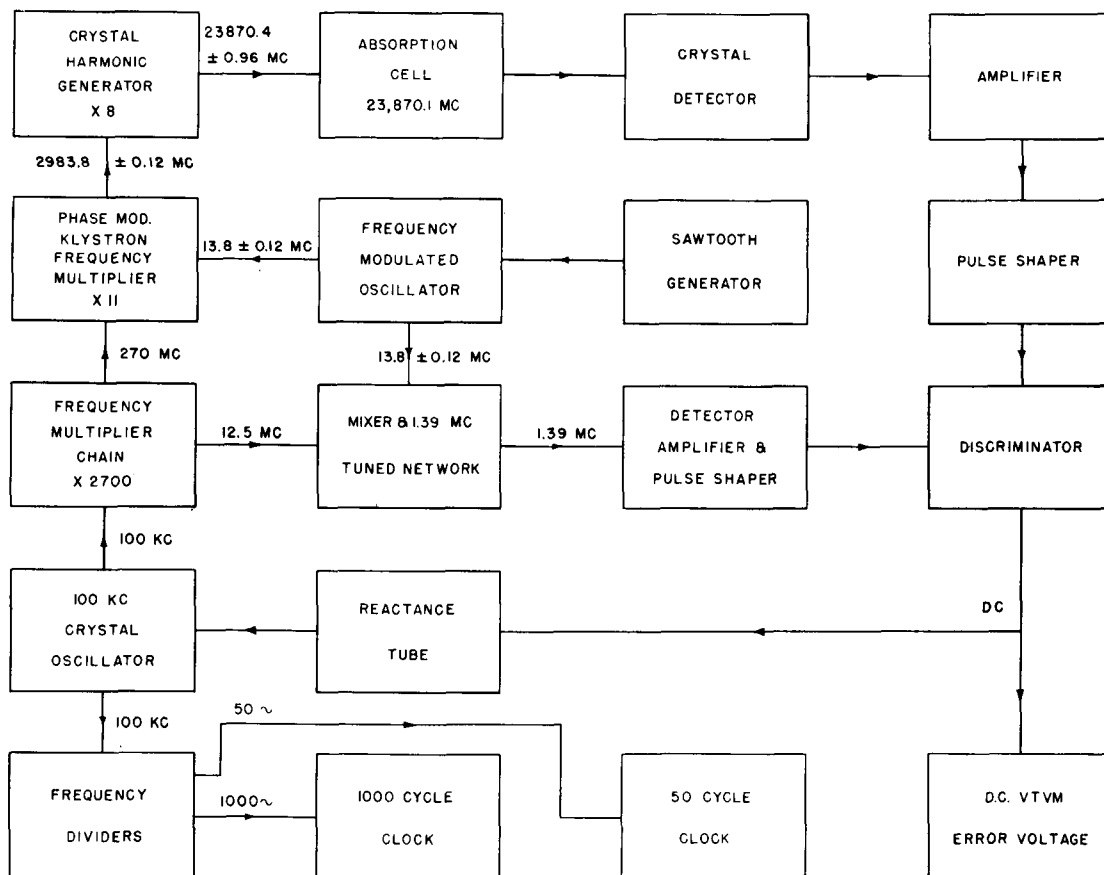

Fig. 10. Block diagram of NBS ammonia clock (courtesy of National Bureau of Standards, Boulder, Colo.).

The NBS group, led by H. Lyons and J. Sherwood, was able to obtain the services of Prof. P. Kusch of Columbia University as a consultant and set out to construct a machine using Rabi's magnetic resonance technique, with the excitation radiation at 9192 MHz being applied to the cesium beam over a 1-cm path by means of a single short-circuited section of X-band waveguide. At the 1952 New York meeting of the American Physical Society, J. Sherwood reported the first successful observation of the  $(F=4, m_F=0) \leftrightarrow (F=3, m_F=0)$  microwave transition [31]. A photograph of the original apparatus involved is shown in Fig. 11. Shortly thereafter, this apparatus was modified for operation with the Ramsey technique of separated oscillating fields. Using a separation of 50 cm, a Ramsey resonance was observed with a line  $Q$  of 30 million, which corresponds to a linewidth of the central peak of the Ramsey resonance pattern of only 300 Hz at 9192 MHz [32]. Based on these results, Lyons predicted an eventual accuracy capability of  $1 \times 10^{-10}$ . The apparatus was soon thereafter disassembled completely and moved to the new NBS site at Boulder, Colo., where, under the direction of R. Mockler, it was eventually reassembled with many new components and improved electronics and used to thoroughly evaluate the precision and accuracy capabilities of cesium beam frequency standards [33]. It was not until the 1958-1959 period that this first cesium beam standard was used to

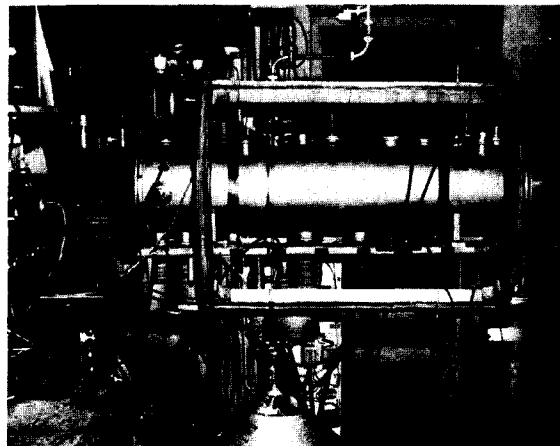

Fig. 11. First operating cesium beam frequency standard—NBS I (courtesy of National Bureau of Standards, Boulder, Colo.).

more or less routinely calibrate the frequencies of the NBS working standards.

Meanwhile, L. Essen and his associates at the National Physical Laboratory (NPL) in Teddington, England, had placed a similar cesium beam apparatus with a Ramsey linewidth of 340 Hz and an accuracy of  $1 \times 10^{-9}$  into operation in June, 1955 [34]. This standard, a photograph of which is shown in Fig. 12, was the first to be used on a regular basis

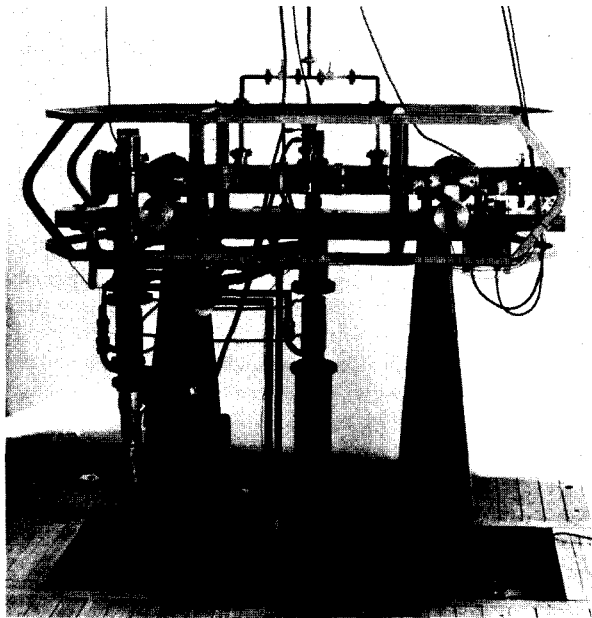

Fig. 12. Original NPL cesium beam frequency standard--NPL 1 (courtesy of National Physical Laboratory, Teddington, England--crown copyright reserved).

for the calibration of secondary working frequency standards. Frequency measurements made with this standard, averaged over the 1955–1958 period, were combined with data from the U. S. Naval Observatory to obtain a determination of the cesium transition frequency (reduced to zero magnetic field conditions) in terms of the astronomical units of time interval [35]. From these measurements resulted the now familiar cesium frequency of 9192.631770 MHz in terms of the Ephemeris second. More recently, in 1964, this value was used to *define* an atomic unit of time interval.

Successful operation of another laboratory-type cesium standard was reported in 1958 by S. Kalra, R. Bailey, and H. Daams at the National Research Council (NRC) in Ottawa, Canada [36]. They achieved a Ramsey linewidth of 290 Hz, a measurement accuracy of better than  $1 \times 10^{-9}$ , and a measurement precision of  $1 \times 10^{-10}$ . During the next year the first cesium standard at the Laboratoire Suisse de Recherches Horlogeres (LSRH) in Neuchatel, Switzerland was operated by J. Bonanomi, J. de Prins, and P. Kartaschoff [37].

In the case of all these early cesium beam standards developed by the various national standards laboratories, the frequency of the oscillator providing the cesium transition excitation was first adjusted manually to the peak of the resonance curve and then compared with the unknown frequency to be measured. Several years earlier, however, in 1954, J. Zacharias, J. Yates, and R. Haun at the Massachusetts Institute of Technology had been able to electronically stabilize the frequency of a quartz oscillator with the  $(4, 0) \leftrightarrow (3, 0)$  transition in cesium [38]. By choosing the time constants of the servo-loop properly, it was possible to combine the superior short-term stability of the oscillator

with the excellent long-term stability of the atomic resonance itself in order to achieve optimum overall performance. The authors suggested that this technique together with a sealed-off cesium beam tube should make a commercial cesium standard feasible.

Building upon these results, R. Daly and others at the National Company, Malden, Mass., developed the first commercial cesium beam frequency standard, termed the "Atomichron," in 1956 [39]. Utilizing a cesium beam tube about 6 feet in overall length, this instrument had a specified stability after one-hour warmup of  $5 \times 10^{-10}$  for measuring periods of greater than 5 seconds for the life of the instrument and an accuracy of  $1 \times 10^{-9}$ . These specifications were later significantly improved as more experience was accumulated. A photograph of one of the early Atomichrons is shown in Fig. 13.

The relative portability of the Atomichron made it possible in March, 1958 to transport two of these instruments to England for direct comparisons with the National Physical Laboratory cesium standard of L. Essen [40]. The results showed that the two Atomichrons agreed to within  $1 \times 10^{-10}$  but differed from the NPL standard by  $2.2 \times 10^{-10}$ . The measurement uncertainties were considered to be  $\pm 5 \times 10^{-11}$ . The relatively close agreement observed, considering the state-of-the-art at that time, was even more remarkable in view of the wide differences existing in terms of the electronics used, the beam optics employed, and the general construction techniques followed for the commercial and NPL instruments.

As new, improved versions of cesium standards evolved in the various laboratories based on the experiences with the early instruments, a trend developed in the various national standards laboratories toward very long machines with the resulting narrow linewidths, while commercial emphasis was directed more toward very short tubes with higher-efficiency beam optics, high reliability, and reduced size, weight, and electrical power consumption.

Long-beam instruments, employing separations between the two oscillating field regions ranging from 2.1 to 4.1 meters, were constructed at NPL in 1959 [41], at LSRH in 1960 [37], at NBS in 1963 [42], and at NRC in 1965 [43]. As a result of the long interaction times between the beam and the RF field, extremely narrow resonance linewidths have been achieved—as low as 20 Hz in the LSRH instrument. In all cases, except for NPL, servo systems have been incorporated in order to stabilize the frequency of a quartz oscillator with the cesium resonance. Comparisons among these four long-beam standards by means of the most recent Hewlett-Packard Company "flying clock" experiment [44] (using cesium standards) indicate agreement to within  $4 \times 10^{-12}$ . The best precision and accuracy figures achieved to date with cesium standards are believed to be  $\pm 2 \times 10^{-13}$  (one sigma estimate for one-hour averaging time) and  $\pm 1.1 \times 10^{-12}$  (one sigma estimate), respectively, reported by Beehler et al., for the NBS standard [45]. Detailed characteristics and performance results for the various individual standards discussed are given elsewhere, in the literature.

Commercial development of cesium beam standards has proceeded rapidly since 1956 with primary contributions from National Company, Varian Associates, Pickard and Burns Electronics, and Hewlett-Packard Company. Recently, the first non-U. S. commercial cesium standard has been introduced by Ebauches, S.A., in Switzerland. These instruments typically weigh about 60 pounds, require  $\approx 50$  watts of electrical power, use solid-state electronics extensively, and fit into about 9 inches of standard rack space [46], [47]. Quoted performance characteristics include  $\pm 1 \times 10^{-11}$  accuracy [46],  $\pm 1 \times 10^{-11}$  long-term stability<sup>3</sup> [46], and 11 000-hour mean time between failures [48]. Considerable progress [49] has been made in the development of a highly refined 27-inch cesium beam tube and associated electronics for the U. S. Air Force with a long-term stability specification of  $\pm 5 \times 10^{-14}$ .

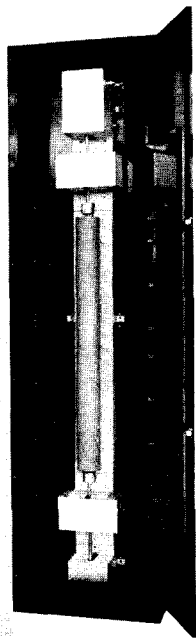

Fig. 13. Early model of National Company Atomichron (courtesy of National Company, Malden, Mass.).

In parallel with the development of cesium beam devices, several laboratories have also constructed atomic beam standards utilizing thallium. Prof. P. Kusch first pointed out in 1957 that thallium should have significant advantages over cesium in an atomic beam frequency standard in terms of its higher transition frequency, its much-reduced sensitivity to external magnetic fields, its much simpler atomic spectrum resulting in the ability to utilize a higher fraction of the atoms comprising the beam with reduced overlap effects from neighboring transitions, and its lower vapor pressure [50]. Disadvantages pointed out were the greater difficulty in detecting the atomic beam and the requirement for larger deflecting magnets.

In 1962 J. Bonanomi was successful in building a thallium atomic beam standard at Neuchatel Observatory in Switzer-

land [51]. A resonance linewidth of 135 Hz, corresponding to a line  $Q$  of  $1.6 \times 10^8$ , was obtained. The difficult problem of detecting thallium atoms was resolved by using the surface ionization technique, as with cesium, but with an oxygenated tungsten detector wire to increase its work function. In assessing the accuracy of the instrument, Bonanomi concluded that all contributions to inaccuracy from the beam tube itself were too small to be detected.

A few months later another thallium standard was placed into operation by R. Beehler and D. Glaze at the National Bureau of Standards [52]. Experiments there also confirmed the high accuracy potential of thallium standards, indicating that for similar-length devices, thallium provides at least as good an accuracy figure as cesium.

Much more recently, R. Lacey at Varian Associates has developed a small (28-inch length), portable thallium beam tube similar to the sealed-off commercial cesium beam tubes [53]. This tube makes use of a heated silver tube as a controllable oxygen leak for continuous oxidation of the tungsten detector ribbon. A novel double-resonance technique, first developed for thallium by J. Bonanomi, was also used by Lacey in order to reduce the size of deflecting magnets needed by making use of atoms which are in states having larger magnetic moments while in the  $A$  and  $B$  deflection magnet regions of the apparatus. A resonance linewidth of only 178 Hz was achieved and the observed signal-to-noise ratio implies a frequency stability of less than  $1 \times 10^{-11}$  for one-second averaging times, provided that shot noise of the beam is the limiting factor.

#### 4A.3.3. Development of Practical Gas Cell Frequency Standards

The successful incorporation of the double-resonance, optical pumping, and optical detection techniques into operating frequency standards using alkali metals, such as sodium, cesium, and rubidium, was achieved by a number of independent laboratories starting in 1958. In that year M. Arditi and T. Carver at the International Telephone and Telegraph Laboratories [54] and W. Bell and A. Bloom at Varian Associates [55] first used the optical detection technique mentioned earlier to observe the field-independent hyperfine resonance in  $\text{Na}^{23}$ . The former, using argon and neon buffer gases, obtained a linewidth of 400 Hz and were able to measure shifts of the resonance frequency as a function of the buffer gas pressure.

About the same time, P. Bender (NBS), E. Beaty (NBS), and A. Chi (Naval Research Laboratory) developed a practical cesium gas cell standard operating on the same  $(4, 0) \rightarrow (3, 0)$  hyperfine transition used in the cesium atomic beam standards [56]. The optical pumping radiation—the  $A \rightarrow C$  component in the simplified scheme of Fig. 6—was obtained from an argon discharge light source operated in a magnetic field of 5000 gauss so that one of the argon emission lines was Zeeman-shifted to a frequency near that of the desired  $A \rightarrow C$  component. Resonance linewidths of as low as 40 Hz, corresponding to a  $Q$  value of  $2 \times 10^8$ , were achieved with neon and helium buffer gases. Extensive data on pressure shifts of various buffer gases with cesium were obtained both in these NBS experiments and in similar

<sup>3</sup> Total drift for the life of the beam tube.

ones conducted by Arditi at ITT Labs [57]. In 1959 Arditi reported some performance results of his cesium gas cell standard [58], including a short-term stability (several seconds) of  $\pm 2 \times 10^{-10}$ , a long-term stability (minutes or hours) of  $\pm 1 \times 10^{-10}$ , and an accuracy of  $\pm 3-4 \times 10^{-10}$ .

The  $\text{Rb}^{87}$  hyperfine resonance had been used in gas cell work as early as 1957 by T. Carver of Princeton University [59]. Utilizing optical pumping to increase the population difference within the hyperfine structure of the rubidium ground state but detecting the microwave transition by observing the microwave absorption, rather than the optical transmission, Carver obtained linewidths of approximately 200 Hz with an argon buffer gas. Shortly thereafter, P. Bender et al. at the National Bureau of Standards developed a new technique [60] for the optical pumping of  $\text{Rb}^{87}$ . A diagram of their experimental apparatus is shown in Fig. 14. The innovation here was the method used to obtain selective pumping from only one of the hyperfine levels of the ground state up to the excited state. Light from a rubidium spectral lamp was filtered by a mixture of  $\text{Rb}^{85}$  and 5 cm Hg of argon. The broadening of the  $\text{Rb}^{85}$  absorption lines produced by the argon in the filter cell caused one of the absorption lines to overlap the lower frequency component ( $B \rightarrow C$  in Fig. 6) of the  $\text{Rb}^{87}$  lamp emitted light. Therefore, the light reaching the sample cell contained mainly the higher-frequency component ( $A \rightarrow C$ ) and the optical pumping process proceeded efficiently. This filtering scheme proved so effective that all present commercial Rb gas cell standards use it. With the apparatus shown, Bender et al. were able to achieve linewidths of only 20 Hz for  $\text{Rb}^{87}$  ( $Q = 3 \times 10^8$ ). They also reported a precision of  $5 \times 10^{-11}$  in setting the microwave signal frequency on the center of the resonance line.

With the accumulation of extensive data on cesium and rubidium gas cell standards from ITT Laboratories, NBS, Varian Associates, Space Technology Laboratories, and NPL (England), among others, three main factors which limited gas cell performance emerged. The first is the nature and density of the particular buffer gas used in the cell. Frequency shifts were found to be directly proportional to buffer gas pressure and were positive for light gases and negative for heavy gases. By using mixtures of positive and negative coefficient buffer gases it was found possible to nearly cancel out the effect. The second factor is the linear dependence of the frequency on the temperature of the gas cell. This effect can also be minimized by proper mixtures and pressures of buffer gases in the cell, but a single choice of such conditions does not minimize both the pressure and temperature shifts. R. Carpenter et al. at NBS obtained temperature coefficients of less than  $1 \times 10^{-11}/\text{C}$  with rubidium as early as 1960 [61]. Both the NBS and ITT Laboratories groups have published measured temperature and pressure shift coefficients for a variety of buffer gases with cesium and rubidium systems [61], [62].

The third limitation on performance is an observed dependence of the frequency on the intensity of the optical pumping light. This is also a linear shift (at least for low buffer gas densities) and is reduced by operating at relatively

high buffer gas pressures and gas cell temperatures. A number of other methods have been proposed to reduce this "light shift" and at present manufacturers of commercial gas cell frequency standards are still devoting much effort to this problem. Data from several laboratories show that if frequency is plotted versus cell temperature for different light intensities, a series of lines result which converge to a single frequency that agrees within experimental uncertainties with the values determined by atomic beam methods

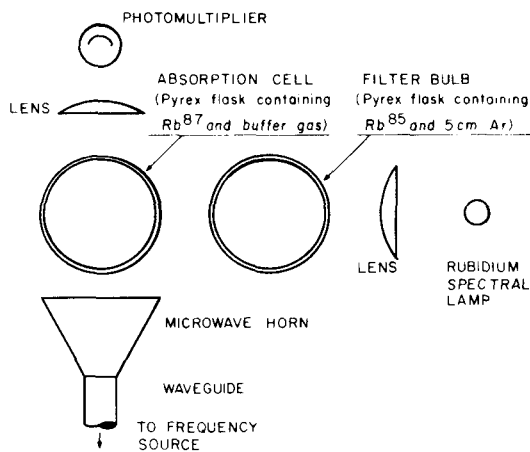

Fig. 14. Schematic diagram of NBS  $\text{Rb}^{87}$  gas cell frequency standard [60].

(after extrapolation of the gas cell data to zero magnetic field and zero buffer gas pressure).

Manufacturers of rubidium gas cell standards, such as Varian Associates and General Technology Corporation, have been able to select and control the important parameters well enough to achieve long- and short-term stabilities of  $1 \times 10^{-11}$  per month and  $1 \times 10^{-11}$  for one second, respectively, in extremely compact packages employing solid-state electronics [63]. Because of the frequency dependence on buffer gas the device must be calibrated initially with respect to a primary standard. From then on, however, the gas cell performs admirably as a secondary standard with typical stabilities as quoted above.

#### 4A.3.4. Development of the Atomic Hydrogen Maser

The atomic hydrogen maser, first developed at Harvard University in 1960 by N. Ramsey, M. Goldenberg, and D. Kleppner [64], was an outgrowth of several of the basic techniques discussed earlier, including those involving buffer gases, atomic beam experiments with stored atoms, and ammonia maser principles. Maser action had not been achieved previously with gaseous atoms in the ground state, primarily because of the much smaller values of the relevant magnetic dipole matrix elements as compared to the electric dipole matrix elements characterizing molecular transitions such as the  $J = 3, K = 3$  resonance used in ammonia masers. This difficulty was overcome in the atomic hydrogen maser by using a "storage bulb" with a non-disorienting wall coating in order to achieve very long effective interaction times

of the order of one second.

The hydrogen maser developed at Harvard combined in a single device several outstanding advantages previously offered in part by a number of different types of atomic frequency standards. For example, an extremely narrow linewidth of about 1 Hz results from the long interaction time. The spectral line is of very high purity in contrast to the complex structure of the ammonia line. Shifts due to first-order Doppler effect are essentially eliminated by virtue of the averaging process as the typical atom makes about  $10^4$  random bounces off the storage bulb walls before undergoing magnetic relaxation from the desired energy state or escapes from the bulb. Finally, the high signal-to-noise ratio characteristic of the maser technique helps to produce the best short-term frequency stability yet observed with any atomic frequency standard.

A schematic diagram of Ramsey's original apparatus is shown in Fig. 15. Atomic hydrogen from a Wood's discharge source first passes through a state separator, just as in the ammonia maser. However, because the transition of interest in hydrogen is a *magnetic* dipole transition, the state separator consists of a hexapole deflecting magnet rather than an electrostatic version. Atoms in the higher energy state of interest ( $F=1, m_F=0$ ) are focused into the quartz storage bulb as indicated by the dashed lines, while the lower-state atoms ( $F=0, m_F=0$ ) are defocused. The storage bulb is centered within a cylindrical resonant cavity tuned to the frequency of the  $(1, 0) \leftrightarrow (0, 0)$  hyperfine transition at 1420 MHz. While bouncing around within the bulb the atoms radiate to the lower energy state and eventually leave the bulb through the entrance aperture after about a second. With the paraffin wall coating first used, at least  $10^4$  collisions with the walls could occur without seriously perturbing the energy states. Teflon coatings have been found to perform even better. With sufficient beam flux ( $\approx 4 \times 10^{12}$  atoms per second) and high enough cavity  $Q$ , maser oscillation was achieved. Not shown in Fig. 15 is a system of Helmholtz coils for applying a small dc magnetic field to the cavity region, corresponding to the  $C$  field in atomic beam magnetic resonance devices. A photograph of this first Harvard hydrogen maser is shown in Fig. 16.

As in the case of the earlier experiments with buffer gases and wall coatings mentioned previously, the maser oscillation frequency was shown both experimentally and theoretically [65] to depend on the wall coating used. Since the collision rate is an important factor, the "wall shift" depends on the bulb size. For bulb diameters normally used the shift amounts to a few parts in  $10^{11}$  but appears to be stable with time. Wall shifts have been measured both at Harvard [66] and by R. Vessot et al. of Varian Associates [67] by measuring maser frequency for different sizes of storage bulbs.

Work on hydrogen masers was undertaken at Varian Associates and at LSRH in Switzerland in 1961. C. Menoud and J. Racine at LSRH [68] and Vessot and Peters at Varian [69] reported successfully operating masers in 1962. The Varian maser has been commercially available for several years and employs many refinements developed for commercial applications, such as elaborate temperature

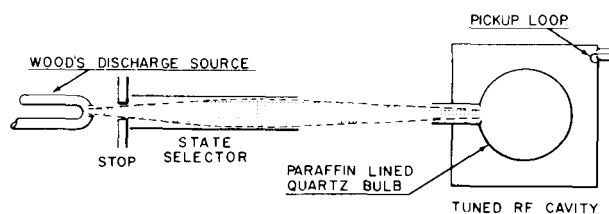

Fig. 15. Schematic diagram of Ramsey's original hydrogen maser [64].

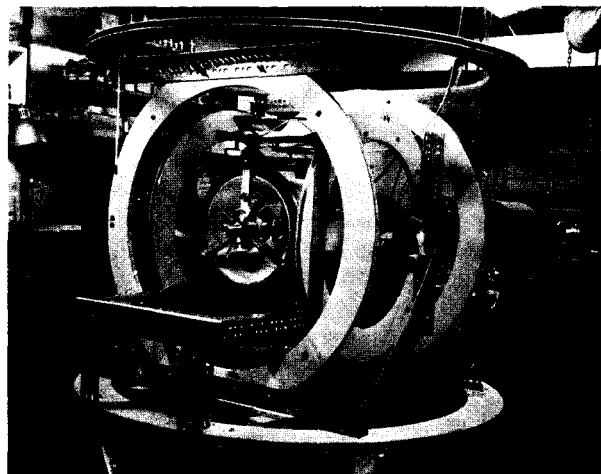

Fig. 16. Ramsey's first hydrogen maser (courtesy of N. Ramsey, Harvard University, Cambridge, Mass.).

control of the resonant cavity to reduce cavity-pulling frequency shifts due to mistuning, provision for effective degaussing of the three-layer magnetic shielding, use of oil-free ion pumps to reduce the possibility of contaminating the wall coating and changing the wall shift, and control of the hydrogen flux by a temperature-controlled palladium leak. More recently, H. Andresen at the U. S. Army Electronics Command (Ft. Monmouth, N. J.) has developed a servo system for automatically keeping the resonant cavity tuned to the frequency of the atomic resonance [70]. Further work on hydrogen masers is currently in progress at many laboratories throughout the world.

For a summary of the present status of hydrogen maser performance results the reader is referred to the article by A. McCoubrey in this issue. It is worth noting, however, that maser stabilities of  $1 \times 10^{-14}$  for averaging periods in the vicinity of 30 minutes and absolute inaccuracies of less than  $1 \times 10^{-12}$  have already been achieved [71]. Since 1963, a number of intercomparisons have been made between hydrogen masers and cesium beam standards involving equipment and personnel from five different laboratories in the U. S. and one in Switzerland. The results [45], [71], with one exception in 1963, show that all measured values of the hydrogen frequency in terms of cesium (after application of appropriate corrections to both the hydrogen and cesium raw data) agree to within the quoted measurement uncertainties, which ranged from  $2 \times 10^{-11}$  to  $1.2 \times 10^{-12}$ .

## 4A.4. CONCLUSIONS

An attempt has been made to at least touch upon the highlights of the historical development of the better known types of present atomic frequency standards. A number of other types, or modifications of existing types, of atomic standards are being investigated in various laboratories and may eventually prove superior to all those discussed here. In this class would be included the large-bulb (60-inch diameter) hydrogen maser now under construction at Harvard University for reduction of wall shifts and cavity-pulling shifts, the rubidium maser with its extremely high short-term stability, masers using other atoms with optical pumping, electric resonance molecular beam devices operating at several hundred GHz, and possibly even lasers if the large frequency gap between RF and the optical region can be successfully bridged. In view of the large amount of effort and resources being put into the development of improved atomic frequency standards at present in many countries of the world it seems likely that the performance of atomic frequency standards will continue to improve rapidly in the foreseeable future.

## 4A.5. REFERENCES

- [1] A. O. McCoubrey, "Relative merits of atomic frequency standards," this issue.
- [2] L. Dunoyer, *Comptes Rend.*, vol. 152, p. 594, 1911.
- [3] W. Gerlach and O. Stern, "On the quantization of direction in a magnetic field," *Ann. Physik*, vol. 74, pp. 673-699, 1924.
- [4] R. Frisch and E. Segrè, "On the adjustment of the direction of quantization," *Z. Physik*, vol. 80, p. 610-616, 1933.
- [5] I. I. Rabi, J. R. Zacharias, S. Millman, and P. Kusch, "A new method of measuring nuclear magnetic moment," *Phys. Rev.*, vol. 53, p. 318, February 1938.
- [6] P. Kusch, S. Millman, and I. I. Rabi, "The radiofrequency spectra of atoms," *Phys. Rev.*, vol. 57, pp. 765-780, May 1940.
- [7] N. F. Ramsey, "A molecular beam resonance method with separated oscillating fields," *Phys. Rev.*, vol. 78, pp. 695-699, June 1950.
- [8] F. Bitter, "The optical detection of radiofrequency resonance," *Phys. Rev.*, vol. 76, pp. 833-835, September 1949.
- [9] J. Brosnel and A. Kastler, *Compt. Rend.*, vol. 229, pp. 1213-1215, 1949.
- [10] J. Brosnel and F. Bitter, "A new double resonance method for investigating atomic energy levels. Application to  $Hg^2P^*$ ," *Phys. Rev.*, vol. 86, pp. 308-316, May 1952.
- [11] A. Kastler, *J. Phys. et Rad.*, vol. 11, p. 255, 1950.
- [12] —, "Optical methods of atomic orientation and of magnetic resonance," *J. Opt. Soc. Am.*, vol. 47, pp. 460-465, June 1957.
- [13] H. G. Dehmelt, "Slow spin relaxation of optically polarized sodium atoms," *Phys. Rev.*, vol. 105, pp. 1487-1489, March 1957.
- [14] R. H. Dicke, "The effect of collisions upon the Doppler width of spectral lines," *Phys. Rev.*, vol. 89, pp. 472-473, January 1953.
- [15] J. P. Wittke and R. H. Dicke, "Redetermination of the hyperfine splitting in the ground state of atomic hydrogen," *Phys. Rev.*, vol. 96, pp. 530-531, October 1954.
- [16] H. G. Robinson, E. S. Ensberg, and H. G. Dehmelt, "Preservation of spin state in free atom-inert surface collisions," *Bull. Am. Phys. Soc.*, vol. 3, p. 9, January 1958.
- [17] W. B. Hawkins, "Optical pumping, buffer gases, and walls," *Proc. 11th Annual Frequency Control Symp.*, pp. 318-323, May 1957.
- [18] R. M. Whitehorn, "Gas cell frequency standards using buffer gases and buffer walls," *Proc. 13th Annual Frequency Control Symp.*, pp. 648-654, May 1959.
- [19] N. F. Ramsey, "Resonance experiments in successive oscillatory fields," *Rev. Sci. Instr.*, vol. 28, pp. 57-58, January 1957.
- [20] D. Kleppner, N. F. Ramsey, and P. Fjelstadt, "Broken atomic beam resonance experiment," *Phys. Rev. Lett.*, vol. 1, pp. 232-233, October 1958.
- [21] H. Goldenberg, D. Kleppner, and N. F. Ramsey, "Atomic beam resonance experiments with stored beams," *Phys. Rev.*, vol. 123, pp. 530-537, July 1961.
- [22] J. Gordon, H. Zeiger, and C. Townes, "Molecular microwave oscillator and new hyperfine structure in the microwave spectrum of  $NH_3$ ," *Phys. Rev.*, vol. 95, pp. 282-284, July 1954.
- [23] N. Basov and A. Prokhorov, "The use of molecular beams in the study of the spectra of molecules by radio spectroscopy," *J. Exp. Theoret. Phys. (U.S.S.R.)*, vol. 27, pp. 431-438, 1954.
- [24] J. Gordon, H. Zeiger, and C. Townes, "The maser - new type of microwave amplifier, frequency standard, and spectrometer," *Phys. Rev.*, vol. 99, pp. 1264-1274, August 1955.
- [25] H. Lyons, "Microwave spectroscopic frequency and time standards," *Electronic Engrg.*, vol. 68, p. 251, March 1949.
- [26] C. Cleeton and N. Williams, "Electromagnetic waves of 1.1 cm wavelength and the absorption spectrum of ammonia," *Phys. Rev.*, vol. 45, pp. 234-237, February 1934.
- [27] B. Bleaney and R. Penrose, "Ammonia spectrum in the 1 cm wavelength region," *Nature*, vol. 157, pp. 339-340, March 1946.
- [28] R. Pound, "Electronic frequency stabilization of microwave oscillators," *Rev. Sci. Instr.*, vol. 17, pp. 490-505, November 1946.
- [29] W. Smith, J. de Quevedo, R. Carter, and W. Bennett, "Frequency stabilization of microwave oscillators with spectral lines," *J. Appl. Phys.*, vol. 18, pp. 1112-1115, December 1947.
- [30] W. Hershberger and L. Norton, "Frequency stabilization with microwave spectral lines," *RCA Review*, vol. 9, pp. 38-49, March 1948.
- [31] J. Sherwood, H. Lyons, R. McCracken, and P. Kusch, "High frequency lines in the hf spectrum of cesium," *Bull. Am. Phys. Soc.*, vol. 27, p. 43, 1952.
- [32] H. Lyons, "Spectral lines as frequency standards," *Ann. N. Y. Acad. Sci.*, vol. 55, pp. 831-871, November 1952.
- [33] R. Mockler, R. Beehler, and J. Barnes, "An evaluation of a cesium beam frequency standard," in *Quantum Electronics, A Symposium*, C. H. Townes, Ed. New York: Columbia University Press, 1960, pp. 127-145.
- [34] L. Essen and J. Parry, "Atomic standard of frequency and time interval," *Nature*, vol. 176, pp. 280-282, August 1955.
- [35] W. Markowitz, R. Hall, L. Essen, and J. Parry, "Frequency of cesium in terms of ephemeris time," *Phys. Rev. Lett.*, vol. 1, pp. 105-107, August 1958.
- [36] S. Kalra, R. Bailey, and H. Daams, "Cesium beam standard of frequency," *Can. J. Phys.*, vol. 36, pp. 1442-1443, 1958.
- [37] P. Kartaschoff, J. Bonanomi, and J. de Prins, "Cesium frequency standards: Description and results," *Helv. Phys. Acta*, vol. 33, pp. 969-973, 1960.
- [38] J. R. Zacharias, J. G. Yates, and R. D. Haun, Jr., "An atomic frequency standard," *Proc. IRE (Abstract)*, vol. 43, p. 364, March 1955.
- [39] W. Mainberger, "Primary frequency standard using resonant cesium," *Electronics*, vol. 31, pp. 80-85, November 1958.
- [40] A. McCoubrey, "Results of comparison: Atomichron - British cesium beam standard," *Proc. 12th Annual Frequency Control Symp.*, pp. 648-664, 1958.
- [41] L. Essen and J. Parry, "An improved cesium frequency and time standard," *Nature*, vol. 184, p. 1791, December 1959.
- [42] R. E. Beehler and D. J. Glaze, "The performance and capability of cesium beam frequency standards at the National Bureau of Standards," *IEEE Trans. on Instrumentation and Measurement*, vol. IM-15, pp. 48-55, March-June, 1966.
- [43] A. Mungall, H. Daams, and R. Bailey, "The Canadian cesium beam frequency standard," *Proc. 20th Annual Frequency Control Symp.*, pp. 436-447, 1966.
- [44] L. Bodily, D. Hartke, and R. Hyatt, "World-wide time synchronization, 1966," *Hewlett-Packard J.*, vol. 17, no. 12, pp. 13-20, August 1966.
- [45] R. Beehler, D. Halford, R. Harrach, D. Allan, D. Glaze, C. Snider, J. Barnes, R. Vessot, H. Peters, J. Vanier, L. Cutler, and L. Bodily, "An intercomparison of atomic standards," *Proc. IEEE (Letters)*, vol. 54, pp. 301-302, February 1966.
- [46] Model 5060 Data Sheet, Hewlett-Packard Company, Palo Alto, Calif., October 1, 1966.
- [47] NC 3501 Data Sheet, National Company, Melrose, Mass.
- [48] L. Bodily, "Performance characteristics of a portable cesium beam standard," *Proc. 20th Annual Frequency Control Symp.*, pp. 448-463, 1966.
- [49] J. Holloway and R. Sanborn, "Characteristics of a high performance cesium beam frequency standard," *Proc. 19th Annual Frequency Control Symp.*, pp. 344-368, 1965.



- [50] P. Kusch, "Precision atomic beam techniques," *Proc. 11th Annual Frequency Control Symp.*, pp. 373-384, 1957.
- [51] J. Bonanomi, "A thallium beam frequency standard," *IRE Trans. on Instrumentation*, vol. I-11, pp. 212-215, December 1962.
- [52] R. Beehler and D. Glaze, "Experimental evaluation of a thallium beam frequency standard," *Proc. 17th Annual Frequency Control Symp.*, pp. 392-407, 1963.
- [53] R. Lacey, "A thallium atomic beam tube for frequency control," *Proc. 20th Annual Frequency Control Symp.*, pp. 416-423, 1966.
- [54] M. Arditi and T. Carver, "Optical detection of zero-field hyperfine splitting of  $\text{Na}^{23}$ ," *Phys. Rev.*, vol. 109, pp. 1012-1013, February 1958.
- [55] W. Bell and A. Bloom, "Optically detected field-independent transition in sodium vapor," *Phys. Rev.*, vol. 109, pp. 219-220, January 1958.
- [56] E. Beaty, P. Bender, and A. Chi, "Narrow hyperfine absorption lines of  $\text{Cs}^{133}$  in various buffer gases," *Phys. Rev.*, vol. 112, pp. 450-451, October 1958.
- [57] M. Arditi and T. Carver, "Frequency shift of the zero-field hyperfine splitting of  $\text{Cs}^{133}$  produced by various buffer gases," *Phys. Rev.*, vol. 112, p. 449, October 1958.
- [58] M. Arditi, "Evaluation of a breadboard gas cell frequency standard," *Proc. 13th Annual Frequency Control Symp.*, pp. 655-667, 1959.
- [59] T. Carver, "Rubidium oscillator experiments," *Proc. 11th Annual Frequency Control Symp.*, pp. 307-317, 1957.
- [60] P. Bender, E. Beaty, and A. Chi, "Optical detection of narrow  $\text{Rb}^{87}$  hyperfine absorption lines," *Phys. Rev. Lett.*, vol. 1, p. 311-313, November 1958.
- [61] R. J. Carpenter, E. C. Beaty, P. L. Bender, S. Saito, and R. O. Stone, "A prototype rubidium vapor frequency standard," *IRE Trans. on Instrumentation*, vol. I-9, pp. 132-135, September 1960.
- [62] M. Arditi and T. Carver, "Pressure, light, and temperature shifts in optical detection of 0-0 hyperfine resonance of alkali metals," *Phys. Rev.*, vol. 124, pp. 800-809, November 1961.
- [63] Manufacturer's specification sheets.
- [64] H. Goldenberg, D. Kleppner, and N. Ramsey, "Atomic hydrogen maser," *Phys. Rev. Lett.*, vol. 5, pp. 361-362, October 1960.
- [65] D. Kleppner, H. Goldenberg, and N. Ramsey, "Theory of the hydrogen maser," *Phys. Rev.*, vol. 126, pp. 603-615, April 1962.
- [66] S. Crampton, D. Kleppner, and N. Ramsey, "Hyperfine separation of ground-state atomic hydrogen," *Phys. Rev. Lett.*, vol. 11, pp. 338-340, October 1963.
- [67] J. Vanier, H. E. Peters, and R. F. C. Vessot, "Exchange collisions, wall interactions, and resettability of the hydrogen maser," *IEEE Trans. on Instrumentation and Measurement*, vol. IM-13, pp. 185-188, December 1964.
- [68] C. Menoud and J. Racine, "Atomic hydrogen maser, description and preliminary results," *Helv. Phys. Acta*, vol. 35, pp. 562-567, September-October 1962.
- [69] R. F. C. Vessot and H. E. Peters, "Design and performance of an atomic hydrogen maser," *IRE Trans. on Instrumentation*, vol. I-11, pp. 183-187, December 1962.
- [70] H. Andresen and E. Pannaci, "Servo-controlled hydrogen maser cavity tuning," *Proc. 20th Annual Frequency Control Symp.*, pp. 402-415, April 1966.
- [71] R. Vessot, H. Peters, J. Vanier, R. Beehler, D. Halford, R. Harrach, D. Allan, D. Glaze, C. Snider, J. Barnes, L. Cutler, and L. Bodily, "An intercomparison of hydrogen and cesium frequency standards," *IEEE Trans. on Instrumentation and Measurements*, vol. IM-15, pp. 165-176, December 1966.

Manuscript received January 6, 1967; revised February 16, 1967.

Reprinted from the PROCEEDINGS OF THE IEEE

VOL. 55, NO. 6, JUNE, 1967

pp. 792-805

COPYRIGHT © 1967—THE INSTITUTE OF ELECTRICAL AND ELECTRONICS ENGINEERS, INC.

PRINTED IN THE U.S.A.

**CHAPTER 4—PART B**  
**RECENT PROGRESS ON ATOMIC FREQUENCY STANDARDS\***

**Roger E. Beehler†**

**Contents**

	Page
4B.1. Introduction.....	103
4B.2. Laboratory Cesium Standards.....	103
4B.3. Hydrogen Standards.....	105
4B.4. Commercial Cesium Standards.....	107
4B.5. Commercial Rubidium Standards.....	108
4B.6. References.....	108

---

\*Manuscript received June 7, 1973.

†Time and Frequency Division, Institute for Basic Standards, National Bureau of Standards, Boulder, Colorado 80302.

"Progress is the activity of to-day and the assurance of to-morrow."  
Ralph Waldo Emerson

Recent progress on laboratory and commercial atomic frequency standards is summarized for the 1967-1973 period. The discussion is restricted to those devices which are judged to be leading contenders in the primary laboratory standards field or which have present or short-term future commercial potential. In the laboratory standards classification a number of cesium beam devices are now in operation with reported accuracies of  $1 \times 10^{-12}$  or better and measured stabilities of a few parts in  $10^{12}$  for 1-second averaging times. Hydrogen standards, in the maser form, have demonstrated the best reported stability yet for moderate averaging times ( $\approx 1000$  seconds) of better than  $1 \times 10^{-14}$ , although the accuracy potential has not yet proved as good as for the cesium beam devices. Other forms of hydrogen standards, operating as passive beam devices, are also under investigation and show considerable promise in both their accuracy and stability characteristics.

Commercial activity remains concentrated on cesium beam and rubidium gas cell standards with hundreds of both types having been sold. Commercial cesium standards are achieving both improved performance—in fact, approaching that of some recent laboratory devices—and a greatly reduced sensitivity to environmental influences. The major rubidium standards improvements have consisted of achieving very respectable stabilities under much more severe environmental conditions and in much smaller package sizes.

**Key words:** Atomic frequency standards; cesium beam standards; hydrogen beam standards; hydrogen masers; rubidium frequency standards.

## 4B.1. INTRODUCTION

Chapter 4A of this volume describes the historical development of various types of laboratory and commercial atomic frequency standards during the period ending in 1967. This chapter is intended to summarize further developments in this field which have occurred in the 1967-1973 period.

Before discussing specific details of some of this more recent progress, it may be of interest to consider briefly the related question of "Why do organizations continue to invest so much time, money, and energy in pursuing work on atomic frequency standards that already possess almost unbelievable accuracy and stability?" The answer—at least in recent years—seems to lie not so much in some rather nebulous desire to "build a better mousetrap" for the challenge and prestige, but rather in the fact that the atomic standard has proved to a great many people that it is a most useful device in a wide variety of applications. As important practical benefits have been realized by the scientific and technological segments of our society from using atomic standards, several trends began to develop more or less simultaneously.

First, based on some of the earlier successful applications of atomic standards in such areas as metrology, navigation, and satellite tracking, systems designers in many other technological areas began thinking in terms of solving their own problems by using time and frequency technology. An example here would be the conceptual design of an aircraft collision avoidance system (ACAS) that is based on time and frequency techniques using state-of-the-art atomic standards for frequency and time reference functions both on board the aircraft and on the ground.

Second, as these new applications appeared, the commercial potential of such devices increased greatly, leading to an intensive development effort to produce better atomic standards in terms of performance, cost, reliability, and suitability for field applications in relatively hostile environments.

Third, in response to the increasing availability of atomic standards with continually improving performance, reduced sensitivity to environmental conditions, and especially at an acquisition cost reduced from the original price in excess of \$50,000 per unit down to under \$10,000, the systems designers were able to consider even more sophisticated systems and techniques, based on the new atomic standards and the related time and frequency technology. We are now seeing some of the practical results in the form of advanced navigation systems, such as Loran-C, Omega, and various military satellite navigation systems; advanced communications systems employing synchronized digital transmissions; and better satellite tracking systems which make use of cesium or hydrogen maser atomic frequency standards. Also, improved methods and equipment have been devised for disseminating highly accurate time and frequency

information over large geographical areas using existing or proposed satellites, television network facilities, and radio navigation systems. The increasing use of atomic standards in scientific applications has already made possible the design and, in some cases, the performance of new relativity experiments [1],<sup>1</sup> significant advances in metrology which may eventually lead to a unified standard for at least time, frequency, and length [2]; and greatly improved knowledge of the earth and other components of our solar system through long-baseline interferometry [3] and satellite-based measurements. For example, the Goldstone LBI system, using hydrogen maser frequency and time references, can already detect relative earth movements with a resolution of about 10 cm. Jet Propulsion Laboratory (JPL) personnel would like even *better* resolutions in order to study possibilities of predicting earthquakes, but are limited at present to 10 cm because the maser references "flicker out" at about  $7 \times 10^{-15}$  [4]. This particular application, and the collision avoidance system mentioned before, are rather interesting because they offer two examples where important public benefits—that is, safety from air collisions and earthquakes—may eventually be rather directly dependent on the existence of atomic standards with state-of-the-art performance.

These interrelated processes that have been described—namely, the increasing availability of useful atomic frequency standards making possible new applications and systems with important benefits to many segments of the population which in turn generate further demands for still better atomic standards—seem likely to continue in the foreseeable future, generating in the process the motivation needed to insure continued development of atomic standards.

## 4B.2. LABORATORY CESIUM STANDARDS

In discussing now more specifically some of the recent progress in this field, it should be noted that recent improvements already achieved in atomic standards and those that will be needed in the future are not confined to better performance, in the sense only of accuracy and stability. In many applications the accuracy and stability already available is adequate for the purpose. But, field use may require greater reliability, less sensitivity to the environmental conditions, smaller size and weight, and simpler operation. In other applications, particularly when several standards are needed, reduced acquisition cost may be the most important consideration.

During the past few years we have already seen substantial improvements with regard to many of

<sup>1</sup> Figures in brackets indicate literature references at the end of this chapter.

these aspects. If we first consider progress from the laboratory standards point of view, cesium beam devices continue to serve as the national reference standards in many nations, based on the 1967 definition of the second in terms of the cesium resonance frequency. Work is still active on hydrogen masers, however, and new techniques using hydrogen beams, for example, may eventually lead to a better absolute standard than cesium.

The state of the art for laboratory cesium beam standards has now advanced to the point where documented accuracies for at least three national laboratory reference standards—those at the National Research Council (NRC) in Canada, the Physikalisch-Technische Bundesanstalt (PTB) in Germany, and the National Bureau of Standards (NBS) in the United States—have been published at  $\pm 1 \times 10^{-12}$  or better [5, 6, 7]. Perhaps the extent of these accomplishments can best be seen by considering the plot in figure 4B.1 showing how published accuracy figures for various laboratory cesium standards have improved over the past 16-year period. The plotted points are generally equivalent to 1-sigma type estimates. While the exact placement of some of the values may be a little uncertain due to some necessary guessing about confidence levels of a few of the published estimates, three conclusions seem fairly clear. First, substantial steady progress has occurred over a long period in designing, building, and evaluating more accurate laboratory cesium standards. Second, several of the present devices have broken the  $1 \times 10^{-12}$  barrier. And, third, further improvement to near the  $1 \times 10^{-13}$  level is already taking place.

The better-than- $1 \times 10^{-12}$  accuracies already achieved have been made possible largely by careful attention to the three principal sources of errors identified in several different laboratories throughout the world as experience was gained with earlier versions of cesium beam standards. These primary sources of inaccuracy are associated with phase shifts in the microwave cavity, uncertainties in the magnetic C-field, and various problems in the excitation electronics.

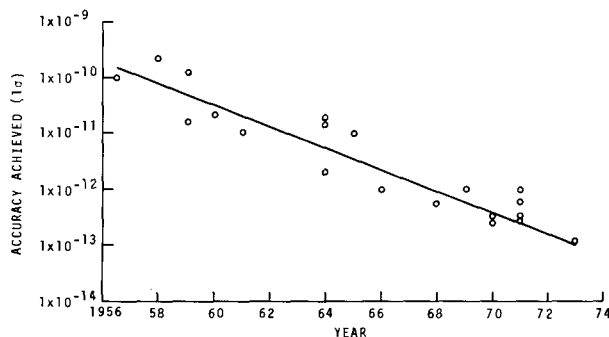

Fig. 4B.1. Accuracy trends in laboratory cesium standards: 1956-1973.

The phase shift problem has been attacked in the recent laboratory standards by providing greatly improved capabilities for detecting the presence and the magnitude of any residual phase shift error using techniques that are convenient enough to permit relatively rapid determinations as often as desired and precise enough so that the *uncertainties* in the phase shift error determination can be much less than  $1 \times 10^{-12}$ . NRC, PTB, NBS, National Physical Laboratory (NPL) in England, and the National Research Laboratory of Metrology (NRLM) in Japan have accomplished this by designing standards which allow the direction of the atomic beam traversal through the microwave cavity to be reversed, thus reversing the sign of any phase shift error in the process. In earlier versions, reversal was accomplished by physically rotating the cavity structure itself or by physically interchanging the cesium oven and detector leaving the cavity undisturbed. Both techniques suffered somewhat from lack of reproducibility, yielding measurement uncertainties of near  $1 \times 10^{-12}$ . The newer standards now in operation at NRC, NRLM, NPL, and NBS include ovens and detectors at each end of the machines so that frequency measurements can be made for each beam direction sequentially in a short time and without disturbing the microwave cavity or interrupting the vacuum inside the beam tube. This technique, using repeated measurements, should reduce uncertainties in the phase shift error correction in these new standards significantly, provided that sufficient knowledge is available concerning the beam velocity distributions and trajectories for each direction of traverse.

A different method for measuring phase shift errors at the  $1 \times 10^{-13}$  level is used in the present PTB standard, consisting of making a frequency measurement at two widely differing mean beam velocities, which can be selected at will by interchanging two different sets of focusing magnets, designed to focus different velocities [8]. Because any phase shift error is velocity dependent, this technique provides a convenient estimate of the error.

Two other techniques are in use at NBS to evaluate possible frequency errors due to cavity phase shift [9]. Both also make use of the fact that any cavity phase shift error present will vary with the mean velocity of the atoms contributing to the resonance signal. With the first method frequencies corresponding to different beam velocities can be measured by varying the input microwave power, since the effective mean beam velocity depends on the power level in the cavity. If the appropriate velocity distributions are known from other measurements (see below) or calculations, the cavity phase shift, and the resultant frequency bias, can be computed.

The second, more novel, technique makes use of pulsed microwave excitation to preferentially select

only a certain narrow range of atomic velocities, according to their time of flight between the two ends of the microwave cavity and the pulse repetition rate [10]. The velocity distribution can be inferred rather directly, and the measurement of the standard's frequency at different velocity settings yields the phase shift bias.

C-field errors, due to magnetic field non-uniformities and instabilities, have also been successfully reduced in most recent standards to below the  $1 \times 10^{-13}$  level. The credit belongs primarily to use of better shielding materials and designs. Several of the newer lab standards are making use of longitudinal C-fields, which can be produced with great uniformity by means of solenoid coils.

Electronic problems continue to provide major difficulties at times in the laboratory cesium beam standards, but some significant progress has been made. Frequency multipliers, beam signal processing components, and even crystal oscillators are now becoming available, which have greatly improved phase-noise characteristics. These inherently more stable circuits, combined with new modulation schemes, such as the square-wave modulation systems in use at NRC and PTB, have resulted in some estimates for inaccuracies contributed by major electronics systems associated with the standard of only about  $1 \times 10^{-13}$  [9, 11].

A final area of increasing concern as accuracy levels below  $5 \times 10^{-13}$  are sought is the uncertainty associated with the correction applied for 2d-order Doppler shift. Better knowledge of the actual beam velocity distribution will be needed for each individual standard in order to attain accuracies near  $1 \times 10^{-13}$ . Studies at NBS and NRC indicate some success in deducing the necessary velocity information from a computer analysis of the experimental Ramsey resonance curves [9, 12]. The pulsed-excitation method mentioned above in connection with the phase shift error evaluation also provides rather directly the velocity information needed for the 2d-order Doppler shift correction.

The stability performance of present laboratory cesium standards, along with some projections for the near future, is summarized in figure 4B.2 by means of a stability versus averaging time plot. Recent state of the art is indicated by the upper band which shows measured 1-second stabilities ranging from  $3 \times 10^{-12}$  for the PTB standard [13] up to about  $1 \times 10^{-11}$  for some of the recent NRC and NBS devices [7, 11]. The upper dashed line shows the performance expected within the next few months from the NBS-X4 beam tube, developed jointly by NBS and the Hewlett-Packard Company. The 1-second stability goal for NBS-X4 is about  $1 \times 10^{-12}$  and results from a relatively large beam flux and an efficient dipole beam optics system. The lower dashed line shows the anticipated stability for NBS-5, a new long-beam standard that is now in the evaluation phase at NBS [9], as inferred from beam noise measurements. This performance results principally from use of a very large beam

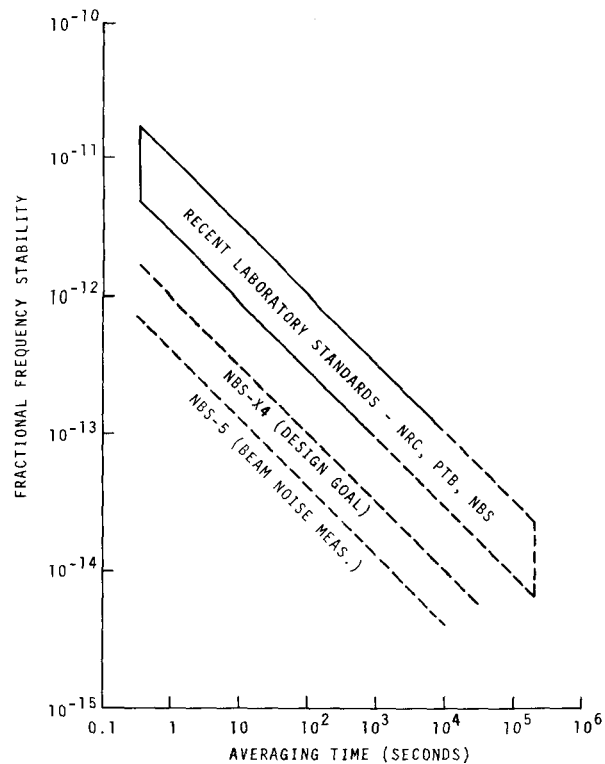

Fig. 4B.2. Stability performance data for laboratory cesium standards.

and an efficient beam optics system designed with the aid of a large digital computer. One motivation for seeking such high stability is that the large number of necessary measurements involved in the accuracy evaluation of such a standard at the  $1 \times 10^{-13}$  level can be performed and repeated in reasonably short time periods.

### 4B.3. HYDROGEN STANDARDS

Although cesium standards have demonstrated very impressive accuracy and stability performance and still seem to have a bright future in the primary standards area, some old and new competitors are also attracting considerable interest. The hydrogen maser, while not yet achieving an accuracy performance that exceeds the laboratory cesium devices, nevertheless has come close, and its stability performance for moderate averaging times has not been matched by any other type of device. The main impediment to accuracies better than about  $1 \times 10^{-12}$  [14, 15, 16] is still the uncertainty in determining the wall shift caused by the hydrogen atoms bouncing off the walls of the storage bulb. Several interesting attempts are being tried to reduce this error source, including the Harvard large-bulb maser, featuring a 150-cm storage bulb intended to reduce the number of wall collisions per second and thus the magnitude of the wall shift by perhaps a factor of 10. The desired accuracy

goal has not yet been reached, but some modifications being added to this maser in the form of a deformable storage bulb may permit the wall shift error source to be reduced to about  $\pm 1 \times 10^{-14}$  [17]. This technique involves the use of a deformable storage bulb built in such a way that the volume of the bulb can be changed by a large factor without changing the bulb's surface area [18]. It allows evaluation of the wall shift without introducing the uncertainties caused by using a series of different size bulbs with similar, but not identical, surfaces. A third method being tried is operation of a maser at a bulb temperature of about 100 °C., where some experiments have shown the wall shift goes through zero [19]. Somewhat on the other side of the coin, however, is the recent suggestion by Crampton that two previously unexpected effects involving hydrogen spin exchange shifts and magnetic field gradients may produce H-maser inaccuracies amounting to several parts in  $10^{12}$  [20].

The stability performance of some hydrogen masers at NRC Canada, Jet Propulsion Laboratory (JPL), NASA Goddard Space Flight Center, and also at Smithsonian Astrophysical Observatory (SAO), is summarized in figure 4B.3. Stabilities as good as  $6 \times 10^{-15}$  have been observed for averaging times in the 100–1000 second range [21, 22].

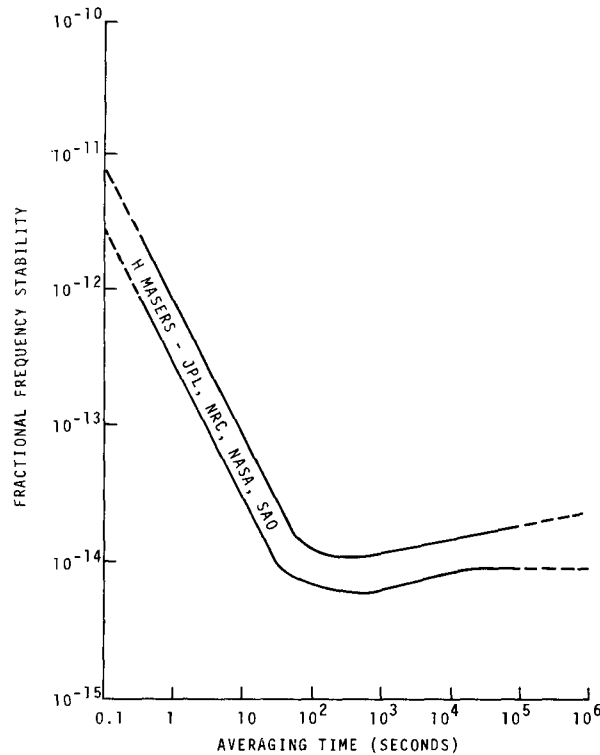

Fig. 4B.3. Stability performance data for hydrogen maser standards.

The NRC maser is a laboratory device; the JPL and NASA versions have been developed for long term, trouble-free operation at NASA tracking sites; and the SAO maser has been developed specifically for relativity tests aboard a spacecraft or rocket vehicle.

Largely because of the wall-shift limitations on the accuracy potential of the hydrogen maser, two groups at NBS and NASA-Goddard have been recently working on other ways for using the simple hydrogen resonance as a frequency standard which do not involve the disadvantages associated with maser action. In both cases the intent is to combine the advantages of the cesium beam and hydrogen maser technologies, while eliminating or reducing some of their disadvantages.

NBS has demonstrated the technical feasibility of a hydrogen storage beam standard which uses a hydrogen beam with atom detection as in a cesium standard, but with the added feature of a storage or bounce box in the beam path [23]. This increases the atom's interaction time with the *rf* field, resulting in a narrower resonance. The technique appears to offer reduced cavity-pulling effects and a better way to evaluate the wall shift in the storage bulb relative to the maser method. Development into a full atomic frequency standard with potentially superior performance will, however, require considerable work on a more efficient detector for atomic hydrogen.

A more basic hydrogen beam standard, without the storage feature, has been built and successfully operated at NASA-Goddard [24]. The operation is similar to that of a cesium atomic beam machine, but some significant advantages are realized with hydrogen due to its much simpler spectrum. Figure 4B.4 shows some of the Ramsey resonance curves obtained at three different C-fields. Because of the simpler spectrum, no overlap occurs between the standard frequency transition and others, even

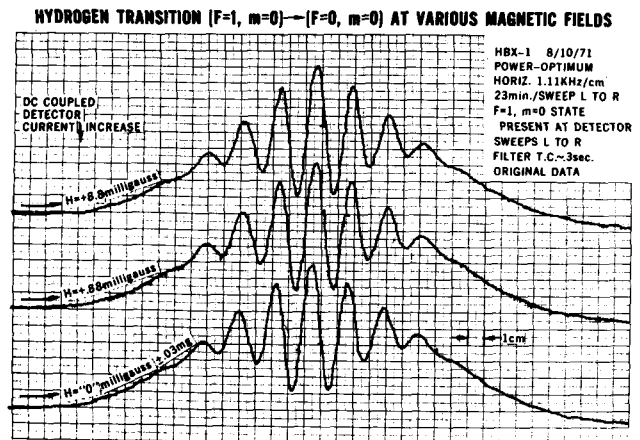

Fig. 4B.4. Hydrogen transition curves from NASA-GSFC hydrogen beam standard (courtesy H. Peters, Goddard Space Flight Center).

at very low C-field values. The Ramsey resonance width shown here of 1.2 kHz was obtained with room temperature atoms and some preferential selection of low-velocity atoms. Although this line Q of about  $1.2 \times 10^6$  is much lower than for present cesium standards, a planned cryogenic beam source may later produce narrower resonances with a resulting increase in line Q. Dr. Peters of NASA-Goddard believes the hydrogen beam standard should prove as stable as the hydrogen maser and is potentially much more accurate—perhaps at the  $1 \times 10^{-13}$  level [24].

NBS has also made some preliminary frequency stability measurements with another variation of a hydrogen storage beam device in which one detects changes in the microwave signal caused by the hydrogen resonance rather than detecting the atoms themselves [23]. An oscillator was locked to the hydrogen transition frequency using the dispersion of the resonance. Stabilities of  $4 \times 10^{-13}$  were observed for averaging times of 30 seconds and 3 hours, using quartz oscillator and commercial cesium references, respectively.

Other potential techniques for laboratory frequency standards, such as ion storage and saturated absorption in methane or other gases are being investigated at several labs [25, 26, 27](see chap. 6).

#### 4B.4. COMMERCIAL CESIUM STANDARDS

The remainder of this paper will attempt to summarize what has been happening recently in the commercial frequency standard field. As has been the case for some time now, recent commercial efforts have been concentrated on cesium and rubidium devices. Hundreds of both types have been sold and new improved versions are appearing on the market in response to the development of new and expanding application areas.

Commercial cesium standards are designed primarily for high stability; reasonable accuracy; small size and weight; moderate electrical power requirements; high reliability; and insensitivity to environmental effects. Presently existing models, and especially some newer versions under active development, show significant advances in each of these areas.

Figure 4B.5 summarizes stability performance for various commercial cesium standards which are either presently available or which are in an advanced stage of development. The upper band, labeled intermediate-performance commercial standards, includes the great majority of commercial cesium standards now in use and some new versions being developed for field applications where small size and weight and intermediate stability performance over a wide range of environmental conditions are the most important design considerations. For example, one manufacturer has succeeded in maintaining this intermediate-level stability performance in a package one-third the size and one-

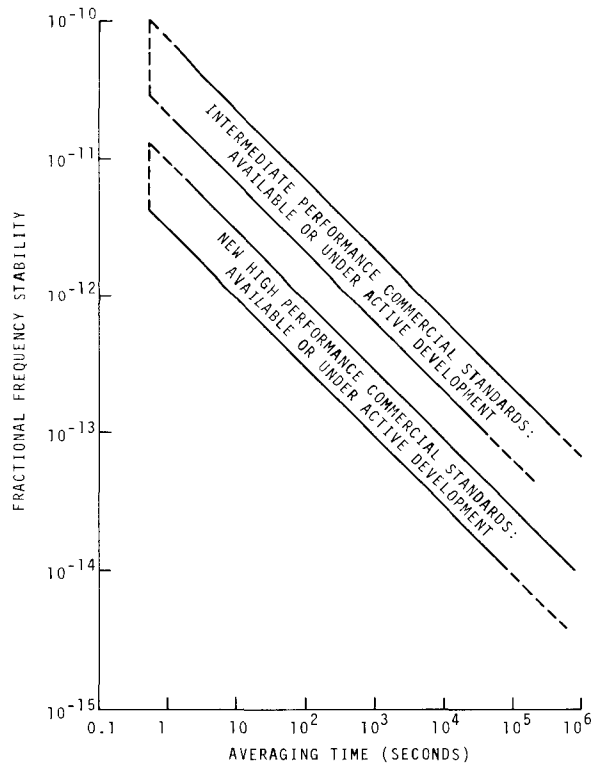

fig. 4B.5. Stability performance data for commercial cesium standards.

half the weight of earlier versions [28]. This achievement is made possible largely through use of a recently developed 15-cm long beam tube, employing six separate pairs of stacked beams to provide a relatively high beam flux. In addition to the high signal-to-noise ratio resulting from this design, its use of back-to-back beam pairs provides a greatly reduced sensitivity of the output frequency to acceleration. Corresponding improvements have been made in the associated electronics and in its performance under severe environmental conditions, such as those encountered in many field applications.

Another manufacturer has independently developed a smaller beam tube with a volume of about 115 cm<sup>3</sup> and an accompanying improved electronics package, which is designed to reduce the user cost relative to previous versions available. The stability of this standard is also expected to fall within the upper band plotted in figure 4B.5 [29].

The lower band in figure 4B.5 indicates some documented and projected results for several versions of high-performance cesium beam tubes developed by private industry. One particular model, already commercially available, is about 40 cm (16 in) long and employs multiple beams for high beam flux [28]. This tube has a specified stability performance equivalent to  $\sigma_y$  (100



seconds) $=9 \times 10^{-13}$  or better [30] and has demonstrated a long-term stability of  $\sigma_y(10 \text{ days})=1 \times 10^{-14}$  [31].

A different design, high-performance cesium beam tube has been developed by another manufacturer which may eventually offer even better performance. Though not yet in commercial production, a prototype version has achieved measured stabilities corresponding to  $\sigma_y(100 \text{ seconds})=3 \times 10^{-13}$  [29]. This tube is about 53 cm (21 in) long and uses a novel form of hybrid beam optics featuring one dipole and one hexapole deflecting magnet. It is interesting to note that the stabilities produced by these commercial high-performance beam tubes are equal to or better than those characteristic of the most advanced laboratory standards until very recently.

Some of the newer commercial cesium standards also reflect significant improvements in their ability to operate within their stated performance limits under rather severe environmental conditions. One model is designed to operate within  $\pm 1 \times 10^{-11}$  over a temperature range from  $-55 \text{ }^\circ\text{C.}$  to  $+74 \text{ }^\circ\text{C.}$  [28]. The same version also provides a greatly reduced sensitivity to external magnetic fields and a much improved stability of its internally-generated C-field by virtue of better magnetic shielding, more efficient degaussing techniques, and an improved C-field structure. More attention has been paid in recent years to the mechanical design of cesium beam standards and the newer units are now less sensitive to shock and vibration effects. In some cases faster warmup of the instrument has been made possible. These advances, when combined with the trend towards smaller size, weight, and electrical power consumption, are likely to stimulate wider use of atomic frequency standards for field applications in the future.

#### 4B.5. COMMERCIAL RUBIDIUM STANDARDS

Recent developments in the rubidium standard marketplace have perhaps been a little less dramatic than for cesium, but nevertheless very significant. Figure 4B.6 presents the current state of the art with respect to the stability performance of commercial instruments. Models manufactured by a number of different companies in the United States, Germany, and Japan provide frequency stability reasonably consistent with the plotted curve. Development efforts in the rubidium case have concentrated primarily on units which maintain the level of performance indicated in figure 4B.6 over wider ranges of environmental conditions; require smaller size, weight, and electrical power; and cost less.

One version has been developed under military contract which has demonstrated state-of-the-art stability performance in military and airborne environments [32]. This rubidium standard has successfully passed all required military speci-

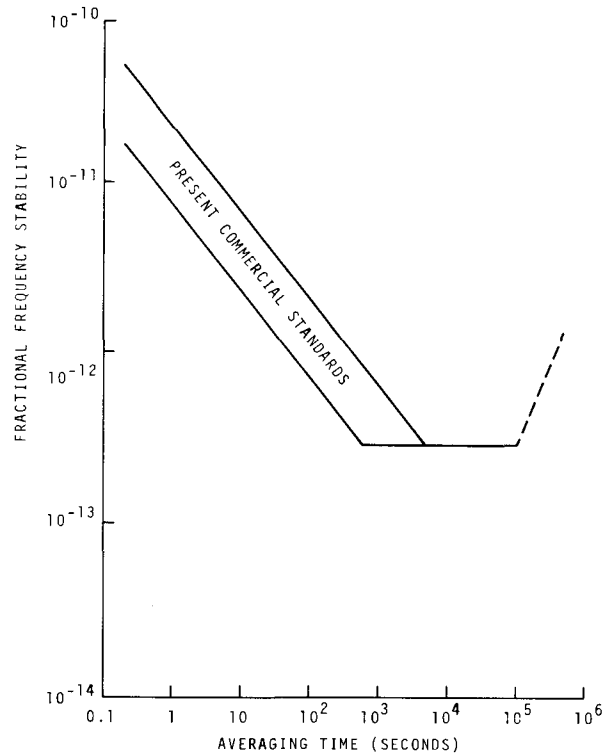

Fig. 4B.6. Stability performance data for commercial rubidium standards.

cations for temperature extremes, shock, vibration, and so forth, staying generally within a few parts in  $10^{11}$  even under the most severe conditions.

Another interesting development in the rubidium standard field has appeared recently in the form of a very compact standard manufactured in Europe, but also commercially available within the U.S. [29]. Although its stability specifications of better than  $5 \times 10^{-11}$  over 1 second and better than  $1 \times 10^{-10}$  from month to month are somewhat inferior to those achieved in larger, commercial units, the device represents a significant technological advance in several other respects. Its packaged size in one form is only about  $10 \text{ cm} \times 10 \text{ cm} \times 11 \text{ cm}$  and it weighs only 1.3 kg. It requires only 10 minutes for warmup, 13 W of electrical power at  $25 \text{ }^\circ\text{C.}$  ambient, and will operate within  $1 \times 10^{-9}$  over a temperature range from  $-25 \text{ }^\circ\text{C.}$  to  $+65 \text{ }^\circ\text{C.}$

#### 4B.6. REFERENCES

- [1] Hafele, J. C., and Keating, Richard E., "Around-the-world atomic clocks: Observed relativistic time gains," *Science*, **177**, No. 4044, pp. 168-170 (July 14, 1972).
- [2] Halford, D., Hellwig, H., and Wells, J. S., "Progress and feasibility for a unified standard for frequency, time and length," *Proc. IEEE (Lett.)*, **60**, No. 5, pp. 623-624 (May 1972) (see chap. 7).
- [3] Klemperer, W. K., "Long-baseline radio interferometry with independent frequency standards," *Proc. IEEE*, **60**, No. 5, pp. 602-609 (May 1972).

- [4] MacDoran, P. F., Private communication (June 9, 1972).
- [5] NRC cesium beam frequency evaluations:
- Mungall, A. G., Bailey, R., Daams, H., and Morris, D., "A re-evaluation of the N.R.C. long cesium beam frequency standard," *Metrologia*, **4**, No. 4, pp. 165-168 (October 1968).
  - Mungall, A. G., Bailey, R., Daams, H., Morris, D., and Costain, C. C., "A preliminary report on Cs V, the new NRC long-beam primary frequency and time standard," *Proc. 27th Ann. Symp. on Frequency Control* (U.S. Army Electronics Command, Ft. Monmouth, NJ 07703, June 12-14, 1973), pp. 317-333 (Electron. Ind. Assn. Washington, DC 20006, 1973).
- [6] Becker, G., Fischer, B., Kramer, G., and Mueller, E., "Diskussion der Inneren Unsicherheit des Neuen Cäsium-Strahl-Zeitnormals der Physikalisch-Technischen Bundesanstalt," (Discussion of the internal uncertainties of the new cesium beam time standard of the PTB), *Proc. Colloque Int. de Chronométrie* (Paris, France, September 16-20, 1969), Ser. A, Paper A2, 9 pages (Nouvelle Faculté des Sciences 11, Quai St., Paris (5<sup>e</sup>) France, 1969) (in German).
- [7] Glaze, D., "Improvements in atomic cesium beam frequency standards at the National Bureau of Standards," *IEEE Trans. on Instrum. and Meas.*, **IM-19**, No. 3, pp. 156-160 (August 1970) (see also chap. 5B for more recent NBS results.)
- [8] Becker, G., Fischer, B., Kramer, G., and Mueller, E., "Neukonstruktion eines Cäsiumstrahl-Zeitnormals an der Physikalisch-Technischen Bundesanstalt," (New construction of a cesium time standard at the PTB), *Proc. Colloque Int. de Chronométrie* (Paris, France, September 16-20, 1969), Ser. A, Paper A1, 12 pages (Nouvelle Faculté des Sciences 11, Quai St., Paris (5<sup>e</sup>) France, 1969) (in German).
- [9] Glaze, D., Hellwig, H., Jarvis, S., Jr., Wainwright, A., and Allan, D., "The new primary cesium beam frequency standard: NBS-5," Chapter 5B, this volume.
- [10] Hellwig, H., Jarvis, S., Jr., Halford, D., and Bell, H. E., "Evaluation and operation of atomic beam tube frequency standards using time domain velocity selection modulation," *Metrologia*, **9**, No. 107-112 (September 28, 1973).
- [11] Daams, H., "Cesium beam servo system using square wave frequency modulation," *Proc. 24th Ann. Symp. on Frequency Control* (U.S. Army Electronics Command, Ft. Monmouth, NJ, 07703, April 27-29, 1970) pp. 294-300 (Electron. Ind. Assn., Washington, DC, 20006, 1970).
- [12] Mungall, A. G., "The second order Doppler shift in cesium beam atomic frequency standards," *Metrologia*, **7**, No. 2, pp. 49-56 (April 1971).
- [13] Becker, G., Fischer, B., Kramer, G., and Mueller, E., "The cesium-beam primary frequency standard CS1 of the Physikalisch-Technische Bundesanstalt," *Proc. Frequency Standards and Metrology Seminar* (Laval University, Quebec, Canada, August 30, 31-September 1, 1971), H. Hellwig (Ed.), pp. 5-16 (Dept. of Elec. Eng., Laval Univ., Quebec, Canada, June 1972).
- [14] Morris, D., "Hydrogen maser wall shift experiments at the National Research Council of Canada," *Proc. 25th Ann. Symp. on Frequency Control* (U.S. Army Electronics Command, Ft. Monmouth, NJ 07703, April 26-28, 1971), pp. 343-347 (NTIS, AD 746211, 1971).
- [15] Essen, L., Donaldson, R. W., Bangham, M. J., and Hope, E. G., "Frequency of the hydrogen maser," *Nature*, **229**, No. 5280, pp. 110-111 (January 8, 1971).
- [16] Hellwig, H., Vessot, R. F. C., Levine, M. W., Zitzewitz, P. W., Allan, D. W., and Glaze, D. J., "Measurement of the unperturbed hydrogen hyperfine transition frequency," *IEEE Trans. on Instrum. and Meas.*, **IM-19**, No. 4, pp. 200-209 (November 1970).
- [17] Reinhardt, V., "Large storage box hydrogen maser with flexible bulb," *Proc. Frequency Standards and Metrology Seminar* (Laval University, Quebec, Canada, August 30, 31-September 1, 1971), H. Hellwig, (Ed.), pp. 158-163 (Dept. of Elec. Eng., Laval Univ., Quebec, Canada, June 1972).
- [18] Debely, P. E., "Hydrogen maser with deformable storage bulb," *Proc. 24th Ann. Symp. on Frequency Control* (U.S. Army Electronics Command, Ft. Monmouth, NJ, 07703, 1970), pp. 259-262 (Electron. Ind. Assn., Washington, DC, 20006, 1970).
- [19] Zitzewitz, P. W., "Surface collision frequency shifts in the atomic hydrogen masers," *Proc. 24th Ann. Symp. on Frequency Control* (U.S. Army Electronics Command, Ft. Monmouth, NJ, 07703, pp. 263-269 (Electron. Ind. Assn., Washington, DC, 20006, 1970).
- [20] Crampton, S. B., "Prospects for the atomic hydrogen maser as a primary frequency standard," *Proc. Frequency Standards and Metrology Seminar* (Laval University, Quebec, Canada, August 30, 31-September 1, 1971), H. Hellwig (Ed.), pp. 117-118 (Dept. of Elec. Eng., Laval Univ., Quebec, Canada, June 1972).
- [21] Morris, D., Daams, H., Mungall, A. G., Bailey, R., Miller, L. G., and Thomson, M. M., "Atomic frequency standards and timekeeping at the National Research Council," *Proc. Frequency Standards and Metrology Seminar* (Laval University, Quebec, Canada, August 30, 31-September 1, 1971), H. Hellwig (Ed.), pp. 119-146 (Dept. of Elec. Eng., Laval Univ., Quebec, Canada, June 1972).
- [22] Finnie, C., Sydnor, R., and Sward, A., "Hydrogen maser frequency standard," *Proc. 25th Ann. Symp. on Frequency Control* (U.S. Army Electronics Command, Ft. Monmouth, NJ, 07703, April 26-28, 1971), pp. 348-351 (NTIS, AD 746211, 1971).
- [23] Hellwig, H., and Bell, H. E., "Experimental results with atomic hydrogen storage beam systems," *Proc. 26th Ann. Symp. on Frequency Control* (U.S. Army Electronics Command, Ft. Monmouth, NJ, 07703, June 6-8, 1972), pp. 242-247 (Electron. Ind. Assn., Washington, DC, 20006, 1972).
- [24] Peters, H., "Hydrogen as an atomic standard," *Proc. 26th Ann. Symp. on Frequency Control* (U.S. Army Electronics Command, Ft. Monmouth, NJ, 07703, June 6-8, 1972), pp. 230-241 (Electron. Ind. Assn., Washington, DC, 20006, 1972).
- [25] Hellwig, H., "Areas of promise for the development of future primary frequency standards," *Metrologia*, **6**, No. 4, pp. 118-126 (October 1970). (See chap. 6).
- [26] Schüssler, H. A., "The ion storage tube, a proposal for a new atomic frequency standard," *Metrologia*, **7**, No. 3, pp. 103-107 (July 1971).
- [27] Hall, J. L., and Borde, C., "Measurement of methane hyperfine structure using laser saturated absorption," *Phys. Rev. Lett.*, **30**, No. 22, pp. 1101-1104 (May 28, 1973).
- [28] Hyatt, R., Throne, D., Cutler, L. S., Holloway, J. H., and Mueller, L. F., "Performance of newly developed cesium beam tubes and standards," *Proc. 25th Ann. Symp. on Frequency Control* (U.S. Army Electronics Command, Ft. Monmouth, NJ, 07703, April 26-28, 1971), pp. 313-324 (NTIS, AD 746211, 1971).
- [29] McCoubrey, A. O., and Kern, R. H., "Precision frequency sources," *Proc. 4th Ann. NASA and DOD Precise Time and Time Interval (PTTI) Plan. Meet.* (NASA, Goddard Space Flight Center, Greenbelt, MD 20771, November 14-16, 1972), pp. 46-54 (NASA X-814-73-72, Greenbelt, MD 20771, 1973).
- [30] Hewlett-Packard Company catalog, p. 281 (1973).
- [31] Winkler, G. M. R., "Intermediate term frequency measurements with the HP computing counter in the USNO clock time system," *Proc. 4th Ann. NASA and DOD Precise Time and Time Interval (PTTI) Plan. Meet.* (NASA, Goddard Space Flight Center, Greenbelt, MD 20771, November 14-16, 1972), pp. 152-167 (NASA, X-814-73-72, Greenbelt, MD 20771, 1973).
- [32] Frerking, M. E., and Johnson, D. E., "Rubidium frequency and time standard for military environment," *Proc. 26th Ann. Symp. on Frequency Control* (U.S. Army Electronics Command, Ft. Monmouth, NJ, 07703, June 6-8 1972), pp. 216-222 (Electron. Ind. Assn., Washington, DC, 20006, 1972).

## CHAPTER 5 – PART A

### IMPROVEMENTS IN ATOMIC CESIUM BEAM FREQUENCY STANDARDS AT THE NATIONAL BUREAU OF STANDARDS

David J. Glaze<sup>†</sup>

#### Contents

	Page
5A.1. Introduction.....	113
5A.2. Modifications to the NBS-III System.....	113
5A.3. Accuracy Capability of NBS-III (1969).....	115
5A.4. Some Immediate Goals.....	116
5A.5. Conclusions.....	116
5A.6. References.....	117

---

<sup>†</sup> Time and Frequency Division, Institute for Basic Standards, National Bureau of Standards, Boulder, Colorado 80302.

"Science moves, but slowly, slowly, creeping on from point to point."  
Alfred Tennyson,  
*Locksley Hall*, l. 134

The National Bureau of Standards Frequency Standard, NBS-III, a cesium beam with a 3.66-meter interaction region, has been in operation since 1963. The last published (1966) accuracy capability for NBS-III was  $1.1 \times 10^{-12}$  ( $1\sigma$ ). Recently, several new solid-state broadband frequency-multiplier chains have been constructed. Reduction of the random phase noise by more than 20 dB compared to the previous state of the art has been obtained consistently. In addition, a solid-state servo system has been installed to control the frequency of the 5-MHz slave oscillator.

Comparisons were made between NBS-III and one of the commercial cesium standards in the NBS clock ensemble. The relative fractional frequency stability  $\sigma(N=2, T=7 \text{ days}, \tau=1 \text{ day})=1 \times 10^{-13}$  was observed for nine weekly comparisons. The very-long-term frequency stability for this recently improved NBS-III system has not been evaluated fully. Due to the improvements both in electronic systems and evaluative techniques, however, an accuracy of  $5 \times 10^{-13}$  ( $1\sigma$ ) for a single evaluative experiment is reported.

Substantial effort is being expended toward improvements of the accuracy of figure of merit (presently 10) of the NBS cesium standard. The modified system, to be called NBS-5, is expected to be in operation in the latter half of 1970 and to exhibit a figure of merit in excess of 500.

**Key words:** Accuracy of NBS-III; cesium beam frequency standard; double beam system; error budget, NBS-III; frequency stability, NBS-III; NBS-III precision; NBS-III servo system; NBS frequency standard; noise effects; quartz crystal reference.

## 5A.1. INTRODUCTION

THE NATIONAL Bureau of Standards Frequency Standard, NBS-III, a cesium beam with a 3.66-meter interaction region, has been in operation since September 1963. From that time until October 1965, NBS-III together with NBS-II, a cesium beam with a 1.64-meter interaction region, comprised the National Bureau of Standards Frequency Standard (NBSFS). By December 1965, NBS-II had been converted to an experimental thallium standard, and two Varian Associates H-10 atomic hydrogen masers and one Hewlett-Packard 5060A cesium beam were operating temporarily at the NBS [1]. The subsequent intercomparison of frequencies among the commercial frequency standards and NBS-III provided the most accurate measurement of any physical quantity, namely the frequency of the hyperfine separation of hydrogen. During these measurements the accuracy capability consistently obtained from NBS-III was  $1.1 \times 10^{-12}$  ( $1\sigma$ ). Improvement of both the accuracy capability and the precision of the NBSFS is a prime objective of the NBS. There are several improvements that have been made since 1965 in NBS-III, the present NBSFS, shown in Fig. 1.

## 5A.2. MODIFICATIONS TO THE NBS-III SYSTEM

During the 1965 intercomparisons mentioned above, it became evident that phase-difference instability in the NBS-III Ramsey cavity [2] was the major source of uncertainty in the frequency of NBS-III [1], [3]. As expected, replacement of the oil-diffusion pumps with ion pumps in mid-1966 reduced both the phase-shift instability and the ultimate pressure. The pressure was improved by a factor of 10 to about  $10^{-8}$  torr ( $1.3 \times 10^{-6}$  N/m<sup>2</sup>), but the phase-difference instability was reduced only by a factor of 2.

The phase-difference instability was not significantly reduced until a precise procedure was followed whenever it was necessary to open the vacuum system. This procedure includes the use of dry highly purified argon gas as the pressurizing agent, as well as thermal control to prevent water condensation. When these techniques were used,

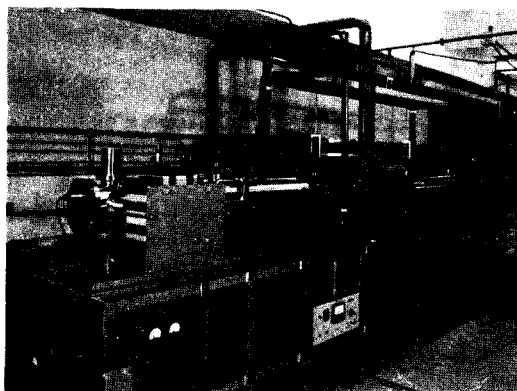

Fig. 1. The NBS-III cesium beam frequency standard, August 1966–August 1969.

the discrepancy between the fractional frequency changes for two reversals of beam direction was  $4.0 \times 10^{-13}$ . These two reversals were made, one at the beginning and one at the end of a 9-month period, as part of independent frequency calibrations. Also the vacuum system was opened several times during this period to recharge the cesium oven. There was no evidence during this period to suggest any phase-difference instability worse than  $4 \times 10^{-13}$ . As a result, the magnitude of the fractional frequency bias correction applied during this period for the phase-difference effect in NBS-III was  $(38.8 \pm 2) \times 10^{-13}$ . The uncertainty of  $2 \times 10^{-13}$ , listed as item 7) in Table I, is one-half the discrepancy noted above. It is apparently attributable to some small amount of chemical reaction on the cavity walls.

Although the results for cavity phase-difference stability are improving, it should be stated that the author regards the proper solution of this long-standing problem to be fourfold.

1) Construct the Ramsey cavity with a low phase difference such that frequency bias due to this effect is not larger than  $1 \times 10^{-13}$  [4].

2) Baffle and getter the beam-coupling holes to the extent that the cesium contamination becomes unimportant.

3) For long interaction-length laboratory standards such as NBS-III, where the highest possible accuracy is

required, construct a double oven and detector system so that beam-direction reversals through the cavity can be accomplished in a matter of hours without breaking the vacuum seals [3].

4) Construct simple electronic systems to monitor with ease the long-term stability of the cavity phase difference, and calibrate these systems initially by means of the double-beam system in item 3). These improvements are presently under construction at NBS and will be installed as modifications to the NBS-III system (see Section IV).

Other improvements have been made, and these are concerned primarily with the NBS-III electronic systems. The basic configuration of the frequency-lock servo system is shown in Fig. 2. The servo system used to control the frequency of the 5-MHz oscillator is a solid-state unit with an improved phase modulator. The modulator is a passive device employing varactor phase modulation of a tuned circuit resonant at 5 MHz. The modulator operates at a fundamental modulation frequency of 18.75 Hz with a second-harmonic level 85 dB below the level of the fundamental modulation. This is an improvement of 30 dB compared to the higher second-harmonic level of the previous modulator and reduces the frequency-pulling effects of modulator second-harmonic distortion to insignificant levels. The remainder of the servo system has numerous test points for measurements to ensure that errors associated with parameters such as demodulator asymmetry, demodulator dc offset, and integrator dc offset can be reduced to low levels. For example, the dc offsets in the demodulator and integrator are typically stable enough and low enough so that no errors as large as  $1 \times 10^{-13}$  accumulate in a two-week period. It is relatively simple to readjust these parameters for an important frequency calibration or to monitor them occasionally during a long run. The stability of this servo is about ten times better than the system it replaced in mid-1968; consequently, the reliability and long-term stability of NBS-III have improved accordingly.

Indeed, the relative fractional frequency stability  $\sigma(N = 2, T = 7 \text{ days}, \tau = 1 \text{ day}) = 1 \times 10^{-13}$  was observed for nine weekly comparisons of NBS-III with one of the two commercial cesium standards that are part of the present NBS clock ensemble [5]. Here  $\sigma^2$  is the Allan variance [6],  $T$  is the period of the sampling, and  $\tau$  is the sample time. Each standard, then, is not worse than  $1 \times 10^{-13}$ , and if the two standards were assigned equal weighting, then one would assign to each the value of  $\sigma = 0.7 \times 10^{-13}$  for the one-day samples just described.

The frequency stability of the cesium beam standard is ultimately limited by the shot noise of the particle detection (surface ionization of the cesium atoms is measured with an electrometer). It is important that the performance of the standard is not degraded by other noise sources, such as a flicker of phase noise process occurring in the frequency-multiplier chains [7] or a flicker of frequency noise process occurring in the 5-MHz quartz-crystal oscillator. These processes are described in detail by Allan [6] and by Cutler and Searle [8]. In

order to meet fully the requirements of improved NBS cesium beam tube designs, it was decided to lower the noise levels generated by the frequency-multiplier chains. Several new solid-state 5–60 MHz multipliers were constructed using local radio-frequency negative feedback in the lower frequency stages to reduce the flicker of phase noise, as suggested and proved by Halford *et al.*, [7]. Improvements in the phase noise level by at least 20 dB compared to the previous state of the art have been obtained consistently. One of these frequency-multiplier chains is presently in use in the 5–60 MHz section of the 9.2-GHz excitation system shown in Fig. 2. For use in future NBS frequency standards, three more of the 5–60 MHz multipliers have just been incorporated in new, all solid-state, 5 MHz–9.2 GHz excitation systems. As expected, the measured phase noise levels of these new systems are also improved by at least 20 dB compared to the levels in previous excitation systems. Fig. 3 demonstrates this fact, and the data shown were obtained at the output frequency of 9.2 GHz.

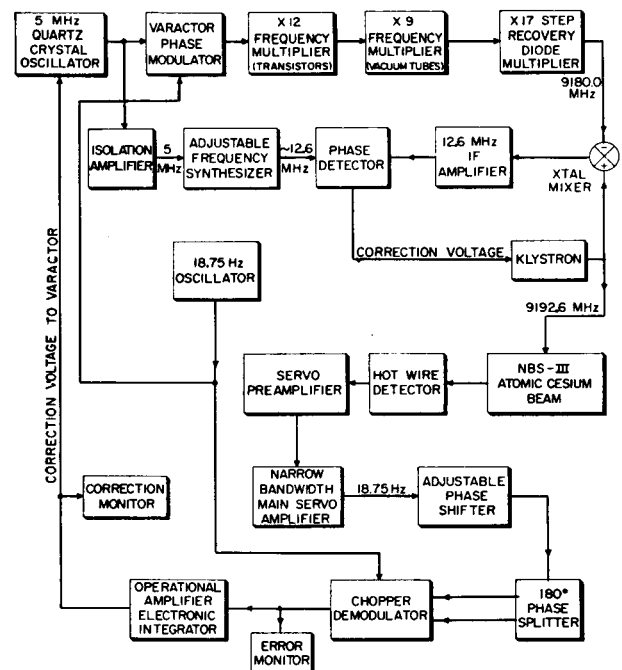

Fig. 2. The NBS-III frequency-lock servo system. The varactor phase modulator and the solid-state frequency multiplier are improved low-noise units.

The quantity  $\mathcal{L}(f)$  in Fig. 3 is a convenient frequency-domain measure of phase fluctuations, and it is defined for one device only, that is, for one amplifier or one frequency-multiplier chain, etc. It is the ratio of the power in one phase-noise sideband, referred to the input carrier frequency, on a per-hertz-of-bandwidth basis, to the total signal power, at Fourier frequency  $f$  from the carrier. The subscript  $-1$  on  $\mathcal{L}_{-1}$  means that the component

of  $\mathcal{L}$  that varies as  $f^{-1}$  is under discussion. In Fig. 3,  $\mathcal{L}$  is seen to vary as  $f^{-1}$  in the vicinity of the modulation frequency (18.75 Hz), that is, flicker of phase noise is the dominant effect. In order to measure their  $\mathcal{L}$  spectrum, the two chains were driven from a single 5-MHz quartz-crystal oscillator, and the phases of the output signals to the phase detector were adjusted for maximum sensitivity to phase noise (phase quadrature). The upper dashed line shows the previous state of the art.

Some improvements had already occurred in reduction of power line related sideband levels, and the new solid-state 5 MHz-9.2 GHz chains are designed to further reduce these effects. These chains are not completely tested so that valid data on power-line related sideband levels are not yet available.

The flicker of phase and the flicker of frequency noise levels observed in the best 5-MHz quartz-crystal oscillators are approximately at the level of the shot noise of the detected beam in the improved cesium beam standards under construction at NBS, evaluated at the optimum frequency of modulation of about 1 Hz. Further improvement in the white frequency noise of cesium beam standards will necessitate improvement in quartz-crystal oscillator frequency stability. A project with the goal of improving the stability of slave oscillators was established at NBS in July 1969.

### 5A.3. ACCURACY CAPABILITY OF NBS-III (1969)

In Table I are listed those effects that contribute significantly to the inaccuracy of NBS-III. The last item is the purely random scatter of the measured NBS-III frequency with running time, for 1-hour averages, in large part due to the shot noise of the beam. All of the other ten items are bias uncertainties. The bias uncertainties do not represent fluctuations with running time, but are instead a measure of the uncertainty of the size of the frequency offset (bias) due to each effect. These offsets tend to remain constant from one measurement interval to the next. However, these offsets may vary whenever changes are made in the apparatus. It is the view of the author that the term "accuracy capability" should be applied to Table I until the long-term behavior of the improved NBS-III system can be evaluated more completely. Accuracy capability is the accuracy attained when a set of evaluative tests is made, as distinct from the accuracy of the standard when left undisturbed for a long period of time [9].

Table II lists a typical set of all the frequency bias corrections applied to NBS-III for each beam direction. All other biases are estimated to be zero within the uncertainties listed in Table I.

Items 1)-6) in Table I, though examined more recently, are identical to the results obtained in 1966 [1], [3] and will not be discussed in detail here. Of these, items 1), 3), and 5) are actually estimated to be slightly smaller than  $.0 \times 10^{-13}$ ; however, since these effects are examined rather infrequently, the uncertainty values were rounded

upward to  $1.0 \times 10^{-13}$ . Item 7) was already discussed in Section II.

In order to evaluate item 8), it was necessary to ascertain the power dependence of the frequency of NBS-III for each beam direction through the resonant cavity [3]. At first it appeared to be impossible to achieve the desired fractional frequency stability of the reference standard of 1 or 2 parts in  $10^{13}$ , because no suitable atomic reference standards existed at the NBS after 1965. It was suggested by Halford<sup>1</sup> that a high-quality quartz-crystal oscillator be used for the reference.

TABLE I  
ACCURACY CAPABILITY OF NBS-III (1969)

Source	$1\sigma$ Estimate Parts in $10^{13}$
1) Uncertainty in average C-field magnitude $ \bar{H}_C $	$\leq 1.0$
2) Use of $\bar{H}_C^2$ for $\bar{H}_C^2$	0.3
3) Uncertainty due to first- and second-order Doppler shifts	$\leq 1.0$
4) Uncertainty due to inequality of average C-field magnitudes in cavity and drift regions, $ \bar{H}_C(t)  \neq  \bar{H}_C(L) $	0.3
5) Uncertainty in C-field polarity-dependent shifts	$\leq 1.0$
6) Uncertainty in cavity tuning	$\leq 0.3$
7) Uncertainty due to cavity phase-difference instability	2.0
8) Uncertainty in power dependent shifts	2.6
9) Multiplier chain transient phase-shifts	$\leq 2.0$
10) Uncertainty due to phasing problems and dc offsets in servo-system electronics	$\leq 2.5$
11) Random uncertainty due to shot noise of beam, for measurement $\tau = 1$ hour	1.6
Total $1\sigma$ estimate of accuracy capability (square root of sum of squares)	$\leq 5.1 \times 10^{-13}$

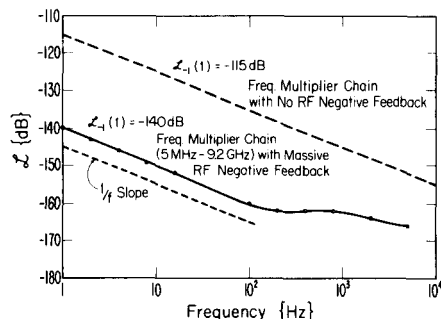

Fig. 3. Normalized spectral density of phase noise power for NBS frequency-multiplier chains.

TABLE II  
TYPICAL FRACTIONAL FREQUENCY BIASES IN NBS-III (1969)

	Beam Direction 1	Beam Direction 2
Magnetic field	$+ 1087.8 \times 10^{-13}$	$+ 1087.8 \times 10^{-13}$
Cavity phase difference	$-38.8 \times 10^{-13}$	$+38.8 \times 10^{-13}$
Finite radiation field intensity (power dependence)	$+7.8 \times 10^{-13}$	$+7.8 \times 10^{-13}$
Second-order Doppler	$-1.8 \times 10^{-13}$	$-1.8 \times 10^{-13}$

<sup>1</sup> D. Halford, private communication, 1968.

The quartz-crystal oscillator is an excellent solution to the problem, as can be seen in Fig. 4, where the methods of Allan are applied [6]. The quantity  $\tau$  is defined as the ratio of  $T$  to  $\tau$ , where  $T$  is the sum of the dead time and the sample time. A suitable sample time  $\tau$  lies between the cesium beam servo time constant ( $\sim 1$  second for NBS-III) and point  $I$ , the intersection of the two curves of Fig. 4. To achieve a high precision, then, the method of synchronous detection is employed. In other words, the microwave power incident on the NBS-III cavity is alternately switched between two predetermined levels 1 and 2, and averaging of the frequency difference occurs for an interval  $\tau$  at each power level. The process continues until the desired quantity of data is obtained. The frequency-difference data are then tabulated in the order in which they occurred, and algebraic differences between the first and second, second and third, etc., are computed and also tabulated. These frequency differences, then, represent the changing frequency of NBS-III as the microwave power alternates between the two levels 1 and 2. The precision obtained in this manner is limited by the number of independent frequency differences obtained, and it is not degraded by crystal-oscillator frequency drift or flicker noise level. In this manner the slopes of the power dependences of the frequency of NBS-III, from the optimum operating power of 1.4 mW down to 0.4 mW, have been determined with precisions consistently between 1 and 2 parts in  $10^{13}$  for both beam directions through the cavity. Harrach [3] has shown that the slopes so obtained from the point of optimum microwave power (that power for which the detected beam intensity is maximized) decreasing downward toward zero power are sufficiently linear that the zero-power extrapolation can be based accurately on these data. The method described by Harrach [3] for extrapolation to zero microwave power was used to estimate

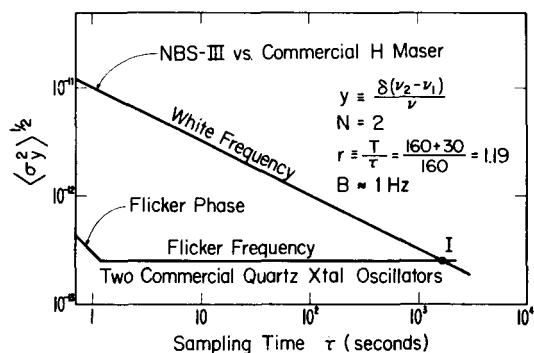

Fig. 4. Relative fractional frequency stability versus sampling time: NBS-III versus a commercial atomic hydrogen maser, and two commercial quartz-crystal oscillators versus each other.

the uncertainty quoted in item 8) of Table I. This value agrees reasonably well with the one obtained in 1965 [1], where hydrogen masers provided the high-stability reference standard. The less expensive quartz-crystal oscillator is ideal for this application.

Items 9) and 10) are improved significantly with respect to the situation existing in 1965 [1]. This improvement is directly attributable to the improved design and performance of the solid-state servo and modulator systems, and the solid-state frequency-multiplier chains as discussed in Section II.

#### 5A.4. SOME IMMEDIATE GOALS

A new solid-state servo system has been designed with particular attention given to reduction of long-term transient effects and leakage signals. It is of even more advanced design than the solid-state servo mentioned in the earlier sections. Also, new completely solid-state 5 MHz-9.2 GHz frequency-multiplier chains have just been constructed, and testing is being conducted now.

Components have been completed for a "double-beam system," that is, a system with an oven and detector at each end of the beam tube. This arrangement should ensure that the phase difference of the new Ramsey cavity can be measured easily, and with high accuracy. The cavity is to be constructed with a very small and very stable phase difference. These components together with new dipole deflecting magnets are to be assembled into a complete, computer-optimized beam optics system [10] using the NBS-III beam tube. Because of the extensive modifications for improved accuracy and precision, the standard will be redesignated NBS-5. It is expected to exhibit a precision  $\sigma$  of measurement for  $\tau = 1$  second of better than  $2 \times 10^{-13}$ . This requires a figure of merit [11] exceeding 500. This corresponds to an improvement by more than a factor of 50 over the present NBS-III system. NBS-5 is expected to be in operation in the latter half of 1970.

#### 5A.5. CONCLUSIONS

It is evident that considerable effort is being expended by National Standards Laboratories to advance the accuracy and precision capabilities of cesium beam frequency standards [12], [13]. It appears likely that development will occur soon of laboratory cesium beam frequency standards with accuracy capabilities of from 1 to 2 parts in  $10^{13}$  ( $1\sigma$ ).

#### ACKNOWLEDGEMENT

The author wishes to express his sincere appreciation to Dr. D. Halford for many helpful discussions and suggestions regarding electronic designs, experiments, and the preparation of this paper. Others of the NBS staff whose efforts are similarly appreciated are Dr. J. A. Barnes for many helpful discussions of the analyses of power spectra and servo systems; A. E. Wainwright for design, development, and test of the phase modulator and of the frequency-multiplier chains; C. S. Snider for assistance in the operation and maintenance of NBS-III, and for considerable mechanical design on NBS-5; and D. W. Allan for very valuable assistance in data acquisition and analysis.



## 5A.6. REFERENCES

- [1] R. Vessot, H. Peters, J. Vanier, R. Beehler, D. Halford, R. Harrach, D. Allan, D. Glaze, C. Snider, J. Barnes, L. Cutler, and L. Bodily, "An intercomparison of hydrogen and cesium frequency standards," *IEEE Trans. Instrumentation and Measurement*, vol. IM-15, pp. 165-176, December 1966.
- [2] N. F. Ramsey, "A molecular beam resonance method with separated oscillating fields," *Phys. Rev.*, vol. 78, pp. 695-699, June 1950.
- [3] Robert J. Harrach, "Some accuracy limiting effects in an atomic beam frequency standard," *Proc. 20th Ann. Symp. on Frequency Control* (Fort Monmouth, N. J.), pp. 424-435, 1966.
- [4] R. F. Lacy, "Phase shift in microwave Ramsey structures," *Proc. 22nd Ann. Symp. on Frequency Control* (Fort Monmouth, N. J.), pp. 545-558, 1968.
- [5] J. A. Barnes, D. H. Andrews, and D. W. Allan, "The NBS-A time scale—Its generation and dissemination," *IEEE Trans. Instrumentation and Measurement*, vol. IM-14, pp. 228-232, December 1965.
- [6] D. W. Allan, "Statistics of atomic frequency standards," *Proc. IEEE*, vol. 54, pp. 221-230, February 1966.
- [7] D. Halford, A. E. Wainwright, and J. A. Barnes, "Flicker noise of phase in RF amplifiers and frequency multipliers: Characterization, cause, and cure," *Proc. 22nd Ann. Symp. on Frequency Control* (Fort Monmouth, N. J.), pp. 340-341, 1968.
- [8] L. S. Cutler and C. L. Searle, "Some aspects of the theory and measurement of frequency fluctuations in frequency standards," *Proc. IEEE*, vol. 54, pp. 133-154, February 1966.
- [9] R. E. Beehler, R. C. Mockler, and J. M. Richardson, "Cesium beam atomic time and frequency standards," *Metrologia*, vol. 1, pp. 114-131, July 1965.
- [10] D. J. Glaze (to be published).
- [11] R. F. Lacey, A. L. Helgesson, and J. H. Holloway, "Short-term stability of passive atomic frequency standards," *Proc. IEEE*, vol. 54, pp. 170-176, February 1966.
- [12] A. G. Mungall, R. Bailey, H. Daams, and D. Morris, "A re-evaluation of the N. R. C. long cesium beam frequency standard," *Metrologia*, vol. 4, pp. 165-168, October 1968.
- [13] G. Becker, B. Fischer, G. Kramer, and E. K. Müller, "Neuentwicklung einer Cäsiumstrahlapparatur als primäres Zeit- und Frequenznormal an der Physikalisch-Technischen Bundesanstalt," *PTB-Mitteilungen*, vol. 79, no. 2, pp. 77-80, April 1969.

Manuscript received February 5, 1970. This work was supported by the National Bureau of Standards, Boulder, Colo. It is based on a talk presented at the 16th General Assembly of the International Scientific Radio Union (URSI), Ottawa, Ont., Canada, August 1969, by Dr. J. A. Barnes, Time and Frequency Division, National Bureau of Standards, Boulder, Colo.

The author is with the Atomic Frequency and Time Standards Section, National Bureau of Standards, Boulder, Colo. 80302.

Reprinted by permission from  
IEEE TRANSACTIONS ON INSTRUMENTATION AND MEASUREMENT  
Vol. IM-19, No. 3, August 1970  
Copyright © 1970, by the Institute of Electrical and Electronics Engineers, Inc.  
PRINTED IN THE U.S.A.

## CHAPTER 5 – PART B

### THE NEW PRIMARY CESIUM BEAM FREQUENCY STANDARD: NBS-5\*

David J. Glaze,† Helmut Hellwig,† Stephen Jarvis, Jr.,†  
Arthur E. Wainwright,† and David W. Allan†

#### Contents

	Page
5B.1. Introduction.....	121
5B.2. The NBS-5 System.....	121
5B.3. Preliminary Experimental Results (Status April 1973).....	122
5B.4. References.....	124

---

\*Manuscript received May 15, 1973

†Time and Frequency Division, Institute for Basic Standards, National Bureau of Standards, Boulder, CO 80302.

"Thus times do shift—each thing his turn does hold; New things succeed,  
as former things grow old."

Robert Herrick

The design of NBS-5 is discussed in detail including its relation to previous NBS primary cesium beam frequency standards. Stabilities of  $3 \times 10^{-14}$  for one day averaging are reported and tentative data on its accuracy capability are given. Preliminary results give an evaluated accuracy of  $2 \times 10^{-13}$  with indications that this figure may be further improved in the future.

**Key words:** Cesium beam standard; Doppler effect; frequency accuracy; frequency stability; power shift; primary frequency standard.

## 5B.1. INTRODUCTION

A primary cesium beam frequency standard serves to realize the unit of time interval, the second, in accordance with the international definition as formulated at the XIII General Conference on Weights and Measures in 1967: "The second is the duration of 9 192 631 770 periods of the radiation corresponding to the transition between the two hyperfine levels of the ground state of the cesium-133 atom" (see chap. 1). The realization of an output frequency from a real device involves several steps of physical and technical processing which may cause frequency deviation of the output frequency from the atomic unperturbed transition frequency. The magnitude of each such bias can be evaluated with the aid of experiments and of theoretical considerations. However, these biases are not known to infinite certainty. The magnitude of these uncertainties depends on the degree of theoretical understanding as well as on the precision with which experimental parameters can be measured. This precision depends on the design and construction of the cesium beam tube and electronics of the primary frequency standard as well as on the frequency stability of the reference frequency standard used in the evaluation of the primary standard. The combined uncertainty of all biases is referred to as the accuracy of the frequency standard.

Since the first atomic clock was realized as an ammonia frequency standard by Harold Lyons at NBS in 1948 [1],<sup>1</sup> several cesium based primary frequency standards have operated at NBS. Standards called NBS-I, NBS-II, and NBS-III served successively as primary frequency standards during the 1950's and 60's [2, 3]. NBS-III, our previous operating frequency standard, was evaluated in 1969 to an accuracy of 5 parts in  $10^{13}$  [3] (see chap. 5A).

The experience gained with NBS-III indicated that the main limitations for accuracy, in addition to significant electronics problems, were the magnetic field—in particular its homogeneity and stability—the second-order Doppler effect, and the cavity phase difference. Therefore the design and construction of a new primary cesium beam frequency standard with the designation NBS-5 was initiated with features incorporated to significantly reduce the above mentioned limitations.<sup>2</sup> The instrument was designed to achieve a frequency accuracy of 1 part in  $10^{13}$ . To facilitate accuracy evaluations, the design also aimed at greatly increasing the stability of the device which is basically given by the available atomic beam intensity and the

line-Q. The stability for 1 hour sampling time of NBS-III was 2 parts in  $10^{13}$ . The NBS-5 design aimed at improving this value by at least 1 order of magnitude, thus allowing measurement precisions approaching  $10^{-14}$  within 1 hour. NBS-5 was put into operation during the latter part of 1972, and has since undergone several phases of accuracy evaluation.

## 5B.2. THE NBS-5 SYSTEM

A photographic view of NBS-5 with all electronics systems is depicted in figure 5B.1. The complete system has a length of about 6 meters overall. The vacuum system is basically a stainless steel tube 25 cm in diameter and is evacuated by three 200 l/s ion pumps which can be closed off with valves for servicing. In order to minimize thermal effects, the Ramsey type cavity is located inside the vacuum system. The total length of the NBS-5 cavity is 3.74 meters. The drift region is carefully shielded by three magnetic shields. The typical operating field is about 60 milli-oersted, and a field homogeneity of better than 1 percent (peak-to-peak variation) is achieved along the beam axis. The beam tube permits an atomic beam to traverse the path through the cavity in either direction. Each end of the beam tube is equipped therefore with both identical magnets and oven-detector combinations. This capability of beam reversal allows a measurement of the cavity phase-difference bias. This bias arises because of a (usually small) difference in the phase of the microwave signal in the two interaction regions. Indeed, the NBS-5 cavity phase difference was adjusted (by length trimming of the two halves) to be less than 1 mrad before the cavity was installed in the beam tube. The resulting bias changes sign if the beam traverses the cavity in the opposite direction.

The oven-detector combination is arranged in such a way that it can be adjusted in the deflection plane of the atomic beam, perpendicular to the beam axis; in addition, the oven can be aimed independently at different angles. The oven can accept ampules filled with 3 g to 5 g of cesium which yield a projected lifetime of many months of continuous operation. The collimator of the oven is an array of about 500 separate channels producing a beam with a rectangular cross section of 2 mm  $\times$  9 mm. With an oven temperature of 100 °C the projected beam intensity at the detector is approximately  $10^8$  atoms per second. The detector is a platinum ribbon. Because of the relatively high beam intensity and the high purity of the platinum ribbon (total background current is of the order of 0.1 pA), no mass spectrometer and electron multiplier are employed. Instead, a field effect transistor is mounted in close proximity to the detector. The detector signal is processed in low-noise preamplifiers external to the beam tube. If one end operates

<sup>1</sup> Figures in brackets indicate the literature references at the end of this Chapter.

<sup>2</sup> Another cesium beam frequency standard with the designation NBS-X4 was also constructed in cooperation with the Hewlett Packard Company. This device was not specifically designed to be used as a primary cesium beam frequency standard, however, new methodology permits such use.

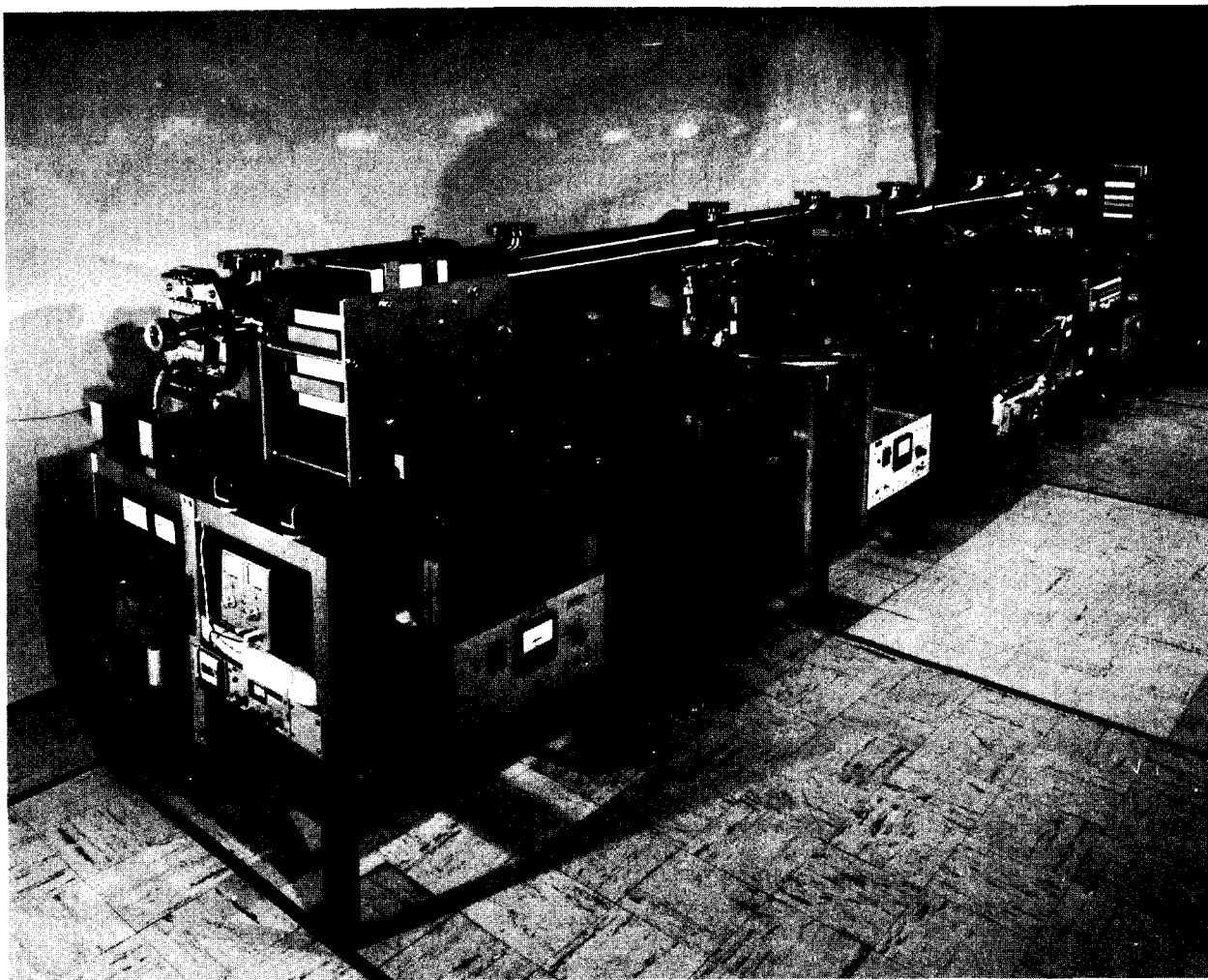

Fig. 5B.1. View of NBS-5. All electronics systems are shown.

in the "oven" mode the detector is moved aside; however, if the end is used in its "detector" mode, the detector can move in front of the oven and, at the same time, a carbon getter plate baffles the oven collimator. Lowering the oven temperature to  $\sim 24^\circ\text{C}$  also reduces its output.

The microwave signal is obtained from a crystal oscillator at a basic frequency of 5.00688 MHz, a subharmonic of the cesium transition frequency. An associated low noise multiplier chain which terminates in a step recovery diode produces a signal at the cesium frequency with a power of up to several mW. A sinusoidal frequency modulation can be applied with a fundamental frequency of 18.75 Hz. This modulation is generated with second harmonic suppression of better than 100 dB. The modulation reappears in the beam current at the detector, is amplified, phase detected, and processed in two cascaded integrators and used to servo-control the crystal oscillator. The 5.00688-

MHz crystal oscillator frequency is also synthesized to a standard 5 MHz frequency. This signal is used for evaluative and stability measurements, and for time-scale calibrations.

### 5B.3. PRELIMINARY EXPERIMENTAL RESULTS (STATUS APRIL 1973)

After a preliminary beam alignment, the  $(F=4, m_F=0) \leftrightarrow (F=3, m_F=0)$  transition was observed with a peak to valley amplitude of 4 pA. Since the atomic velocities are determined by the beam optics and the beam alignment, linewidths of 25 to 45 Hz were measured depending on the alignment. The signal to noise ratio was also measured, and from this by Lacey's method [4], the frequency stability for 1 s sampling times was calculated to be 4 parts in  $10^{13}$ . Our best reference sources in stability measurements for very short times were

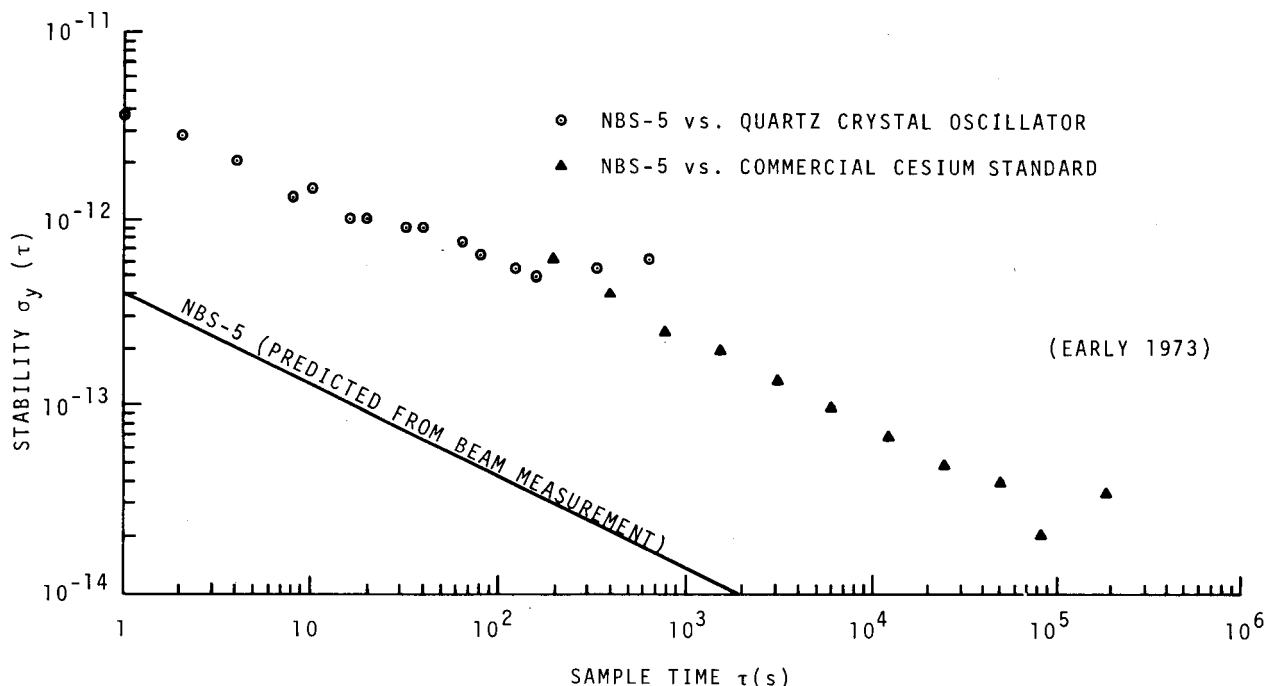

Fig. 5B.2. Measured and calculated frequency stability of NBS-5.

crystal oscillators, and for longer times were commercial cesium beam frequency standards. A plot of the measured square root of the Allan variance using both of these reference oscillators is shown in figure 5B.2 together with the calculated stability of NBS-5. Figure 5B.2 shows that we were able to obtain measurement precisions in the accuracy evaluation of about 3 parts in  $10^{14}$  for sampling times of  $10^5$  s. The calculated, shot noise limited stability is better than the measured performance. This is mostly due to limitations in the electronics; i.e., due to noise associated with the beam detector electronics, the servoed quartz crystal oscillator, etc. In the long term measurements, the available commercial cesium reference was also limiting the measurements precision.

At the time of this writing, for various technical reasons, we have not proceeded yet with the beam reversal. However, we have preliminary accuracy data based on two other methods:

(1) Power shift measurements [5-7]. This method is based on the fact that the effective mean atom velocity is a function of the interrogating microwave power. To use this method it is necessary (a) to know the velocity distribution in the tube (this can be obtained experimentally from pulsed operation and refined by matching a derived Ramsey spectrum with the experimentally obtained Ramsey spectrum), (b) to calculate numerically the effective mean velocities at given microwave power settings, and (c) to measure the change in the output fre-

quency by comparison with a reference standard at different microwave power settings. This allows a calculation of the cavity phase difference and the corresponding frequency bias. It must be verified, that the microwave spectrum is of sufficient purity so as not to introduce spectrum related power shifts.

(2) Pulse method [6, 7]. This method is based on selecting certain velocities in the beam by pulsing the microwave power. The velocity selection is based on the time of flight between the two cavity interrogation regions. This method also allows a measurement of absolute microwave power levels in the cavity and the determination of the velocity distribution.

With methods 1 and 2 one can obtain the biases due to the second order Doppler effect and the cavity phase difference. Our preliminary results are tabulated in table 5B.1. More detail on the biases and the bias uncertainty can be found in reference [8]. The other biases and bias uncertainties of which we are aware and which we have evaluated in a preliminary way are also listed. Biases not assigned a value are nominally zero within the respective uncertainties shown. From table 5B.1 we can see that the cavity phase difference is about 0.7 mrad which leads to a bias (including the second order Doppler effect) at nominal optimum microwave power of about  $1.5 \times 10^{-12}$ . We have monitored these values every month during the first three

TABLE 5B.1.

Preliminary Accuracy Budget for NBS-5

Influencing factors	Bias	Bias uncertainty
1. 2d-order Doppler and phase difference at nominal optimum power; source: power shift & pulse method	$-14.5 \times 10^{-13}$	$1.6 \times 10^{-13}$
2. servo system; source: some variation of servo parameters and calculations based on measured offsets and loop gain	—	$1 \times 10^{-13}$
3. magnetic field; source: $m_F \neq 0$ transitions	$1,670.0 \times 10^{-13}$	$0.2 \times 10^{-13}$
4. $\bar{H}^2$ versus $\bar{H}$ ; source: $m_F \neq 0$ transitions and measurements during assembly	—	$0.4 \times 10^{-13}$
5. Majorana transitions; source: $m_F \neq 0$ transitions and measurements during assembly	—	$0.05 \times 10^{-13}$
6. pulling of neighboring lines; source: $m_F \neq 0$ transitions	$-0.05 \times 10^{-13}$	$0.02 \times 10^{-13}$
7. cavity pulling; source: worst estimate	—	$0.1 \times 10^{-13}$
8. rf spectrum; source: spectrum recording	—	$0.4 \times 10^{-13}$
9. random uncertainty ( $1\sigma$ at 10 h); source: stability measurements against other cesium standards	—	$< 0.4 \times 10^{-13}$

months of 1973. We could not find any change in the cavity phaseshift within our measurement precision. If all the bias uncertainties are statistically treated, i.e., we assume that they are independent and uncorrelated, we obtain a total accuracy capability of 2 parts in  $10^{-13}$ . It should be noted however, that all of these reported data ought to be regarded as tentative, preliminary values, subject to later verification and/or correction. For the future we plan to understand fully the beam optics alignment and the magnetic field properties of the beam tube. In addition, we expect to compare the computer-aided beam optics design with actual performance. We also intend to further investigate and refine the pulse method as well as the power shift method, and we will attempt to obtain compatible results with beam reversals. Only after all these tests are completed do we feel that final accuracy figures can be quoted for NBS-5. Further improvements in accuracy seem likely in view of

new ideas and evaluation methods for NBS-5, and in view of the beam tube performance to date. In addition, the availability of an accurate and very stable reference standard, i.e., NBS-X4, is expected to facilitate evaluation of NBS-5 and to lead to further improvements in accuracy.

## ACKNOWLEDGMENTS

The authors wish to express sincere appreciation for the help of the late J. H. Holloway whose continued interest and support over several years have contributed very significantly to the success of this present work.

The authors appreciate the considerable help of L. S. Cutler and L. F. Mueller of the Hewlett Packard Company. The authors also wish to thank their colleagues J. A. Barnes, D. Halford, W. D. McCaa, Jr., H. F. Salazar, and C. S. Snider for their help throughout many phases of the work on NBS-5.

A special word of commendation should be given to Ward T. Roberts who constructed almost all of the NBS-5 beam tube.

*Note added in proof:* Comparisons between NBS-5 and NBS-X4 in November 1973 led to a measured frequency stability of  $\sigma_y(\tau) = 1.3 \times 10^{-12} \tau^{-1/2}$  (for one device), reaching a measured value of  $1 \times 10^{-14}$  in 3.5 hours. Also, successful beam reversal supports the previously obtained values for the bias correction and the associated accuracy claim.

## 5B.4. REFERENCES

- [1] Lyons, H., "Spectral lines as frequency standards," *Ann. N.Y. Acad. Sci.*, **55**, pp. 831-871 (November 1952).
- [2] Beehler, R. E., and Glaze, D. J., "The performance and capability of cesium beam frequency standards at the National Bureau of Standards," *IEEE Trans. on Instrum. and Meas.*, **IM-15**, Nos. 1 & 2, pp. 48-55 (March and June 1966).
- [3] Glaze, D. J., "Improvements in atomic cesium beam frequency standards at the National Bureau of Standards," *IEEE Trans. on Instrum. and Meas.*, **IM-19**, No. 3, pp. 156-160 (August 1970) (see chap. 5A.)
- [4] Lacey, R. F., Helgesson, A. L., and Holloway, J. H., "Short-term stability of passive atomic frequency standards," *Proc. IEEE (Special Issue on Frequency Stability)*, **54**, No. 2, pp. 170-176 (February 1966).
- [5] Hellwig, H., Barnes, J. A., Glaze, D. J., and Kartaschoff, P. K., "Frequency shifts due to Ramsey type interrogation in atomic beam tubes," Nat. Bur. Stand. (U.S.) Tech. Note 612, 25 pages (USGPO, February 1972).
- [6] Mungall, A. G., "Cavity phase dependent frequency shifts in cesium beam frequency standards," *Metrologia*, **8**, No. 1, pp. 28-32 (January 1972).
- [7] Hellwig, H., Jarvis, S., Jr., Halford, D., and Bell, H. E., "Evaluation and operation of atomic beam tube frequency standards using time domain velocity selection modulation," *Metrologia*, **9**, No. 3, pp. 107-112 (September 28, 1973).
- [8] Glaze, D. J., Hellwig, H., Jarvis, S., Jr., Wainwright, A. E., and Allan, D. W., "Recent progress on the NBS primary frequency standard," *Proc. 27th Ann. Symp. on Frequency Control* (U.S. Army Electronics Command, Ft. Monmouth, NJ 07703, June 12-14, 1973), pp. 347-356 (Electron. Ind. Assn., Washington, D.C. 20006, 1973).

## CHAPTER 6

### AREAS OF PROMISE FOR THE DEVELOPMENT OF FUTURE PRIMARY FREQUENCY STANDARDS

Helmut Hellwig†

#### Contents

	Page
6.1. Introduction.....	127
6.2. Effects on Frequency: Particle Interrogation.....	127
6.3. Effects on Frequency: Particle Confinement.....	129
6.4. Effects on Frequency: Particles and Particle Preparation.....	130
6.5. Existing Concepts for Quantum Electronic Frequency Standards.....	131
6.6. Frequency Stability for One Second Averaging.....	133
6.7. Accuracy Capability.....	133
6.8. Conclusions.....	134
6.9. References.....	135

---

†Time and Frequency Division, Institute for Basic Standards, National Bureau of Standards, Boulder, Colorado 80302.



"Brief words, when actions wait are well: The prompters hand is on the bell—Behind the curtain's mystic fold The glowing future lies unrolled."

Francis Bret Harte

This paper discusses possibilities which may lead to the development of future primary frequency standards of superior accuracy capability. Aspects of cost and field-usage are totally neglected. A review is given of the various methods and techniques which are currently employed in quantum electronic frequency standards or which have a potential usefulness. Various effects which influence the output frequency of a primary standard are associated with these methods. They are discussed in detail, and expectation values for the related uncertainties are given. For selected particles certain methods of interrogation, confinement, and particle preparation can be combined such as to minimize the net uncertainty due to all applicable effects. Different technical solutions are the result. A review of existing and proposed devices is given, including quantitative data on the stability and accuracy capability. Aspects of the most promising devices are discussed, and it is concluded that accuracy capabilities of  $10^{-14}$  should be within reach of today's research and development.

**Key words:** Accuracy (frequency standards); figure of merit; frequency stability; future primary frequency standard; gas cells; ion storage; masers; particle confinement; particle interrogation; particle preparation; primary frequency; quantum electronic frequency standards; storage beam.

## 6.1. INTRODUCTION

A primary frequency standard is based ultimately on some fundamental property of nature. The actual realization of an output frequency involves several steps of physical and technical processing. Each of these steps may cause a more or less pronounced shift of the output frequency of the standard. The magnitude of each shift must be evaluated theoretically and experimentally. The resulting corrections are called the biases; however, they are never known exactly but have associated with them uncertainties. The magnitudes of these uncertainties depend on the degree of theoretical understanding, on experimental parameters, and on their measurability. The combined uncertainty of all biases is referred to as the accuracy capability of the frequency standard.

At present the standard with the highest accuracy capability is the cesium atomic beam tube. This fact is reflected in the agreement at the 13th General Conference on Weights and Measures (1967) to define the second as the duration of 9192 631 770 cycles of the unperturbed radiation of the  $\text{Cs}^{133}$  hyperfine transition ( $F = 4, m_F = 0$ )  $\longleftrightarrow$  ( $F = 3, m_F = 0$ ). The cesium beam tube, although it still can be improved, is already at a very advanced stage of technical development. An accuracy capability of the order of parts in  $10^{13}$  is now a reality which is achieved in several laboratories around the world [1—5]. However, a natural demand exists for an even more accurate definition, and frequency standards of extreme precision will be needed in various technical applications. New aspects of scientific, technical, and metrological importance have evolved because of recent successes in multiplication of frequencies into the infrared region of the electromagnetic spectrum [6—10]. A substitution of conventional length (wavelength) measurements by much more precise and accurate frequency measurements will soon be possible and may ultimately lead to a unified (frequency) standard for frequency, time and length with the speed of light being a defined constant. We may look even further ahead to the possibility that other basic physical quantities, e.g., the volt via the Josephson

effect, will be based on the same (frequency) standard. This illustrates the far reaching importance which we have to attribute to the development of primary frequency standards.

In the following we will compare and discuss possibilities in methods and techniques which are at our disposal for pushing the fractional frequency accuracy capability beyond  $10^{-13}$ . This will be done in a way which differs somewhat from the usual approach of comparing different existing devices [11]. Instead we will compare the methods and techniques used in quantum electronic frequency standards, and we will try to synthesize from these an optimized device. As the criterion for excellence in this comparison it appears best to choose accuracy capability as the prime topic in our discussions. The influences affecting the frequency of a quantum electronic frequency standard can be grouped into three classes: (1) effects associated with the interrogation of the atoms or molecules, (2) effects related to the method of confining the particles, and finally (3) effects associated with the particles themselves and with the way in which they are treated for an effective interrogation by electromagnetic fields.

We will discuss these three groups successively in more detail. Since we are aiming for accuracies of better than the present state-of-the-art (parts in  $10^{13}$ ) we will discard as unimportant only those effects which lead to fractional uncertainties of less than  $10^{-14}$ . At this point it should be emphasized that the following discussion is based on our present state of knowledge. There might well be other methods and techniques which could be used, and there might be additional sources of uncertainty of which we are not yet aware. We also are not going to discuss basic physical and engineering details of the various techniques and devices. They may be found in the referenced literature. In particular, Refs. [11—15] will give an introduction to the problem area in historic perspective.

## 6.2. EFFECTS ON FREQUENCY: PARTICLE INTERROGATION

In a quantum electronic frequency standard we are

not only concerned with the actual quantum transition of the particles (clock transition) involved but also with the production of an output signal. In general two different tasks are to be accomplished: (a) the generation of a signal which is to be compared with the actual "clock" transition, and (b) the generation of a useful standard frequency output. It is obvious that at least one oscillator—in general, more than one—is necessary for these tasks. These slave oscillators may be quartz crystals, klystrons, lasers, or any other suitable devices. They must be locked in frequency or in phase to the "clock" transition. This can be accomplished by four distinctly different methods: The active maser oscillator [16–19], whereby its output frequency is compared to a synthesized frequency derived from the slave oscillator; the absorption [20–22] or amplification [16] of an electromagnetic frequency by the atomic or molecular transition; the detection and counting of the number

where  $T_r \equiv$  relaxation time, and  $n_s \equiv$  flux of signal particles. The constant  $K$  contains the device characteristics. As examples we have for particle detection [24, 26] (which includes detection of photons with  $h\nu > kT$ )

$$K_{\text{passive}} \geq \frac{1}{2\pi\nu}, \quad (3)$$

and for an active oscillator (with  $h\nu \ll kT$ ) [16, 26] we have

$$K_{\text{active}} \geq \frac{1}{\sqrt{2}\pi\nu} \sqrt{\frac{kT}{h\nu}}. \quad (4)$$

From these equations we see that the flux of signal atoms and the relaxation time which make up our basic figure of merit  $M$  are not the only important parameters in determining frequency stability. The principle which is used in the interrogation of the particles is also important, and is reflected in the value of  $K$ . For example at  $h\nu \ll kT$  a device (with the same  $M$  for each version) will have a better noise performance when passive particle detection is used as compared to using the mode of operation as an active quantum electronic oscillator [27]. This can be seen by comparing (3) and (4). Also, additive thermal noise at any reasonable particle or photon intensity is negligible, and excess noise contributions of particle or photon detectors are typically very low. Thus shot noise of the incoming particles is usually the only limitation. In contrast we almost always will encounter additional noise in an active (maser) oscillator because of performance limitations in its microwave receiver.

Another potential noise source is the frequency multiplier and synthesis chain connecting the slave oscillator to the "clock" transition. The current state-of-the-art is such that this noise contribution is negligible compared to the noise due to the slave oscillator [1, 28]. Noise can also be associated with the quantum transition itself, i.e., in the form of spontaneous emission. Such effects will become more serious at higher (optical) frequencies because the probability for spontaneous transitions increases as the cube of the transition frequency.

The short-term stability of the slave oscillator is of equal importance for all methods because its performance determines the stability of the whole standard at short averaging times [26]. The only remedy is the development of good slave oscillators.

Spectral asymmetry of the interrogating signal is of concern for all passive devices [29, 30]. It can be reduced to unimportance by adequate care in the electronics. Also the choice of a low frequency transition might be helpful. In active devices this problem is practically non-existent.

For many devices a resonance structure (cavity) is necessary to create the required strength and spatial distribution of the interrogating electromagnetic field. This leads to the possibility of cavity pulling which may be written as [16, 29]

$$\Delta\nu \equiv G \Delta\nu_c \quad (5)$$

Table 1. *Effects on frequency; Particle interrogation*

Methods	Effects
Active: Self-oscillation	Noise in:
Passive:	Detector
Absorption or amplification of radiation	Receiver
Particle detection	Resonance structure
Frequency transformation	Multiplier and synthesizer
	Quantum transition
	Slave oscillator fluctuations
	Spectrum asymmetry
	Cavity pulling
	Interrogating radiation

of particles having undergone a transition caused by a signal which is derived from the slave oscillator [1, 23, 24]; and finally the observation of transitions by their effect on other transitions of different frequencies to which the "clock" transition is coupled [25] (frequency transformation). In the first column of Table 1 the different interrogation methods are summarized.

The second column lists various effects which give rise to bias uncertainties and which are associated with one or more of the methods of interrogation.

The fractional frequency stability [26] of a quantum electronic frequency standard may conveniently be written as

$$\sigma_y \equiv \frac{K}{M} \frac{1}{\sqrt{\tau}}. \quad (1)$$

The symbols in (1) have the following meaning:  $\tau$  is the measurement interval;  $M$  is a basic figure of merit<sup>1</sup> given by

$$M \equiv \sqrt{n_s} T_r, \quad (2)$$

<sup>1</sup> This  $M$  differs from traditional figures of merit found in the literature.

where  $\Delta\nu_c$  and  $\Delta\nu$  are the offsets of the cavity and the output frequencies respectively. For an active oscillator the parameter  $G$  is approximately the ratio of the widths of clock transition and cavity resonance [16], for passive methods (sufficiently far from self-oscillation)  $G$  is approximately the square of this ratio [29]. Thus an active oscillator is inherently more affected by cavity pulling than a passive device. Moreover a sharp cavity resonance, i.e., a larger  $G$ , is a prerequisite for an active oscillator [16] whereas a broad cavity resonance or—at least in principle—no resonance structure at all, i.e.,  $G = 0$ , can be used with passive methods. Cavity pulling is therefore only of concern to active oscillators.

For laser oscillators we have  $G \approx 1$  which rules out their use as frequency standards. The stability of the output frequency would be directly given by the mechanical stability of the optical resonator.

The last item in Table 1 is the effect caused by the interrogating signal itself. One example is the Bloch-Siegert frequency shift [30]. The fractional frequency shift is related to the power of the interrogating signal and can be expected to be negligible for all techniques under discussion if excessive power levels are avoided [30]. Another example is the recoil effect which may be a serious limitation if the photon energy of the interrogating radiation is large (infrared and optical frequencies). They are discussed in more detail later in this paper under Conclusions.

We summarize: A passive method is to be preferred over an active oscillator. In addition a passive method offers more flexibility and freedom for evaluating bias corrections and accuracy limitations, because a passive technique is not tied to meet an oscillation threshold condition. A low frequency (microwave) transition eliminates some of the problems; however, higher frequencies (infrared) may be used if technical problems associated with the multiplication process<sup>2</sup> can be adequately solved. At high frequencies (optical) effects associated with photons of higher energy (recoil) could represent a serious limitation.

### 6.3. EFFECTS ON FREQUENCY: PARTICLE CONFINEMENT

A quantum electronic frequency standard is based ideally on the quantum transition of a particle (atom or molecule) which is in an unperturbed state and is interrogated for an indefinite period of time.

In principle this may be achieved by confining an ensemble of particles to that region of space which is filled with the interrogating radiation and to accomplish this confinement in such a manner as to minimize the perturbation of the individual particles. In reality it appears possible to realize the ideal of a free particle to a very good approximation; however, it is at the expense of interrogation time, and vice versa.

<sup>2</sup> We may assume that multiplication, in principle, is possible.

Various methods of confinement are at our disposal. We may use a beam of free particles travelling in vacuum through the region of space where interrogation takes place [22, 23]. We may store the particles in the region of interrogation at low particle densities by using storage vessels. The storage vessel has to be coated [31, 32] or filled with a buffer gas [17, 33] in order to reduce the interaction between the particles and the wall of the storage vessel and among particles themselves. Or we can do away with physical walls and use electric or magnetic fields for confinement [34]. Finally, we may just take a gas at a fairly high pressure and observe absorption [20, 21] of the interrogating radiation. A summary of these methods is given in the first column of Table 2.

Various effects (listed in the second column of Table 2) which lead to bias uncertainties are introduced by the confinement of particles.

Several effects are associated with the line- $Q$  which is proportional to the product of confinement time and transition frequency. They include short term stability, cavity pulling, and the performance of the servo electronics. A high line- $Q$  is desirable but not essential because means can be employed to counter the effects of a low line- $Q$ , e.g., one could render cavity pulling totally unimportant, regardless of the line- $Q$ , by avoiding a resonance structure (using a passive method). On the other hand a high line- $Q$  can be obtained with relatively short confinement times by using transitions at high frequencies. For achieving a long duration of confinement, i.e., in excess of one second, storage methods offer the greatest potential, especially the coated vessel or the usage of confining fields (ion storage). Collisions between the particles which lead to spin exchange and shifts of the energy levels are an important source of uncertainty in techniques using comparatively high particle densities. Low density methods like the free beam, the storage in a coated bulb, or the usage of confining fields can be designed to render this effect unimportant. We also may arrange the interrogation mode in such a way as not to look at particles which have experienced a collision, e.g., as in saturated absorption [20]. Wall collisions will introduce uncertainties wherever physical walls are used as a means of confinement. Only the free beam and the

Table 2. *Effects on frequency: Particle confinement*

Methods	Effects
Traveling free beam	Line- $Q$
Storage in:	Particle-particle collisions
Coated vessel	Wall interaction
Buffer gas	1st order Doppler
Electric or magnetic fields	2nd order Doppler
Absorption cell	Cavity phase shift

confinement by fields are not affected<sup>3</sup>. However, we may also use an absorption cell and restrict the region of interrogation to a small volume within the cell [20], e.g., by using a laser beam as the interrogating radiation, thus avoiding wall effects. The first order Doppler effect appears to be mainly a design and engineering problem and thus of no real consequence for this discussion. We may assume that a suitable approach in all of the discussed methods will eliminate first order Doppler frequency shifts and line broadening. This may be done by proper interrogation (e.g., saturated absorption [20]), by storage within dimensions less than one half of a wavelength of the interrogating radiation [18], or by a proper mechanical design as required in the case of a free beam traveling through a Ramsey cavity [23]. The second order Doppler shift is of a more fundamental nature. It can be regarded as the problem to know with adequate precision the speed or temperature of the particles. This is difficult in the case of the free beam and is a severe problem in the case of storage in electric or magnetic fields, whereas the use of physical containers allows an adequate knowledge of the temperature, when thermal equilibrium of the kinetic energy of the particle with the container walls can be established. Cavity phase shift offsets occur in the case of the free beam traveling through a cavity [1—5]. For all other methods it is of no concern.

We summarize: The choice of a high frequency transition is to be preferred because this leads to a reduction of the fractional importance of most effects; the Doppler shifts, of course, are excluded. Thus the (second order) Doppler limitation favors the storage in containers where thermal equilibrium exists between the kinetic energy of the particles and the walls of the storage vessel. At low (microwave) frequencies we cannot single out a specific method of confinement as being inherently superior to others.

#### 6.4. EFFECTS ON FREQUENCY: PARTICLES AND PARTICLE PREPARATION

The particles which we choose are either atoms or molecules, and we may use any of the different types of electric or magnetic dipole transitions. In order to effect interrogation, the particles are generally prepared so that this can be done efficiently. Preparation usually means the creation of a population difference of the energy levels which differs from (is larger than) the thermal distribution.

Only at high frequencies, above one terahertz, does the preparation of particles lose its importance, because of the large population differences already present in thermal equilibrium. This allows efficient absorption of the interrogation signal without preparation. Possible methods of preparation are listed in the first column of Table 3.

<sup>3</sup> For the case of a magnetic dipole transition this is true when the particles (ions) are confined by electric fields.

Spatial state selection achieves the change in population difference by eliminating one or more energy states from a particle beam<sup>4</sup> [35]. This method is based on differences in the electrostatic or magnetic forces acting in inhomogeneous electric or magnetic fields on the electric or magnetic dipole moments which are associated with each energy state. Optical pumping can be used which causes changes in population difference when the pumping light acts on the energy levels selectively by proper use of polarization, filtering [36], etc. Electron collisions can be used to alter the population of the energy levels from the thermal equilibrium values. As examples, electron beams of well defined energy or a gas discharge can be employed. A change in population can also be accomplished by spin exchange collisions with atoms or molecules which have already been polarized by any of the other methods [34]. Chemical effects may be used such as a chemical reaction or a dissociation which lead to the formation of excited particles.

Again we find various effects associated with the different methods which give rise to bias uncertainties. They are listed in the second column of Table 3. The influence of external electric fields can be made unimportant if magnetic dipole transitions such as the hyperfine transitions in atoms are used [37]. Magnetic fields can be rendered unimportant when certain molecular transitions are taken [38]. Shielding will reduce the effects of both. Majorana transitions may occur if particles travel through regions of varying static field strength and thus are mainly of some importance for spatial state selection. Frequency uncertainties are introduced by transitions from neighboring states. This effect can be minimized by the choice of particles with a simple energy level structure and by carefully avoiding the stimulation of neighboring transitions.

Two classes of effects, listed in Table 3 as collisions and coupling of transitions, represent significant sources of frequency bias (and uncertainty) for all methods other than spatial state selection and absorption. Coupling of transitions occurs when the pumping radiation is present simultaneously with the interrogating radiation. Collisional effects will be encountered when collisions are used as a means of altering the population difference. The very method used for particle preparation is the source of a frequency bias (and uncertainty), and the more efficiently the preparation is made, the more restrictive is its effect on the performance as a primary frequency standard. In principle, we have a solution. In analogy to spatial state selection we may separate spatially the process of particle preparation from the particle interrogation. This can be done, for example, with two storage vessels connected by a diffusion channel or by using a traveling beam. An alternate solution is the

<sup>4</sup> This method dates back to the famous Stern-Gerlach experiment.

separation in time of particle preparation and interrogation (pulsed preparation). However, we must

Table 3. *Effects on frequency; Particles and particle preparation*

Methods	Effects
Atoms	Electric fields
Molecules	Magnetic fields
No preparation (absorption)	Majorana transitions
Spatial state selection	Neighboring transitions
Optical pumping	Coupling of transitions
Electron collisions	Collisions
Spin exchange	
Chemical reaction	

realize that both solutions will encounter technical problems in their practical realization although they are fundamentally feasible.

We summarize: An atom or molecule should be used which has a simple energy level structure and properties which reduce the effects of external electric and/or magnetic fields. Obviously, the best choice for a particle preparation method is no preparation at all (simple absorption). However, we must then use transitions in at least the low terahertz range where the population difference in thermal equilibrium is sufficiently large for efficient interrogation. The optimum method of particle preparation at low (microwave) frequencies appears to be the spatial state selection.

## 6.5. EXISTING CONCEPTS FOR QUANTUM ELECTRONIC FREQUENCY STANDARDS

We will discuss only those quantum electronic frequency standards with a current or potential accuracy capability of better than one part in  $10^{10}$ . Several devices have been developed, and some are even commercially available. They include the forerunner of all, the ammonia maser [16, 39], the rubidium gas cell [40], the cesium beam tube [1—5, 23], and the hydrogen maser [18, 19]. Two more devices have had a preliminary evaluation but are not nearly as mature as those previously mentioned: the thallium beam tube [41, 42] and the rubidium maser [17]. Several more concepts are being proposed or are in the early stages of experimentation. They include saturated absorption of laser radiation (methane [20], iodine [21], sulfurhexafluoride [43], etc.), simple absorption of laser radiation by a traveling beam (iodine [22]), other beam tubes (barium oxide [44]), ion storage (helium [34], mercury, etc.), and the storage beam tube (hydrogen [27]).

We will now look into the basic operating principle of each device and discuss briefly the chief limitation of each by comparing with Tables 1 to 3. It must again be emphasized that any effect imposing an accuracy limitation of worse than one part in  $10^{14}$  will

count as a limitation. No attempt will be made at quoting quantitatively these limitations. For those devices which have been evaluated, the reader is referred to the published data in the referenced literature. For all other devices and concepts it seems futile to quote data which cannot adequately be supported. In order to form his own opinion the reader should consult the referenced literature. Finally it must be emphasized that the limitations quoted here

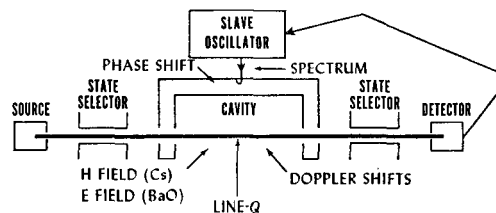

Fig. 1. Traveling beam tube

should not be regarded as final. They merely reflect the present state of our knowledge, and future work is likely to change them.

(a) *Traveling Beam Tube (Fig. 1)*. The beam of particles originates at a suitable source or oven and travels through a first state selector which focuses only certain, desired energy states into the cavity region. Here the particles are interrogated by a microwave signal. As a result the distribution of particles into the various energy states is altered when the particles leave the cavity region. This is analyzed by a second state selector which focuses particles in selected energy states on a detector thus generating the error signal for a slave oscillator. Limitations are the spectrum of the interrogating radiation (Table 1); the phase difference between the two sections of the Ramsey cavity, the second order Doppler shift due to the uncertainty in the mean square particle velocity, and the relatively low line- $Q$  (Table 2); and in the case of cesium and barium oxide the effects of fields (Table 3).

(b) *Absorption in a Beam (Fig. 2)*. The beam of particles originates in a source and travels freely through a vacuum chamber. A laser which serves as the slave oscillator radiates perpendicularly onto the particle beam. Changes in the intensity of the laser radiation due to absorption in the beam can be detected (in-line position in Fig. 2), or alternately the intensity of the fluorescence radiated by the traveling beam may be monitored (displaced position in Fig. 2). Limitations are the spectrum of the laser radiation and the radiation itself via photon effects (Table 1); and the first and second order Doppler effects (Table 2).

(c) *Traveling Beam Maser (Fig. 3)*. The only example is the ammonia maser. A beam of molecules leaves the source, is state selected, and enters a cavity which is tuned to the transition frequency. Because of the short interaction time between the particles and

the microwave field in the cavity a large particle flux is required to obtain self-oscillation. Also, the delivery

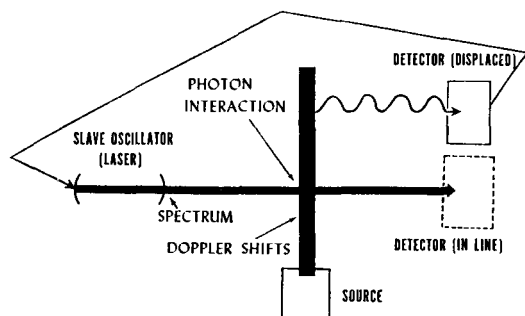

Fig. 2. Absorption in a beam

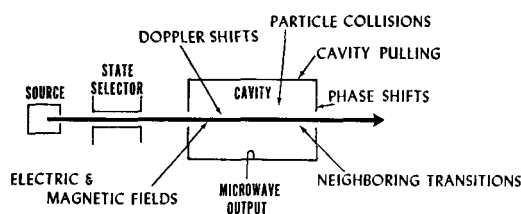

Fig. 3. Traveling beam maser

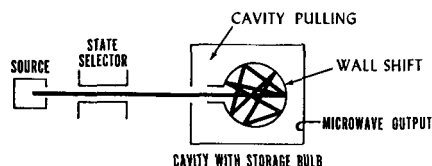

Fig. 4. Storage beam maser

of the energy from the molecules to the cavity is in general not uniform and not symmetric along the length of the cavity. This together with the more complex level structure of ammonia leads to the following: Cavity pulling (Table 1); first and second Doppler shifts, particle collisions, and cavity phase shifts (Table 2); and electric fields, magnetic fields, and the influence of neighboring transitions (Table 3).

(d) *Storage Beam Maser (Fig. 4)*. The only example is the hydrogen maser. A state selected atomic beam is generated in a fashion similar to the beam tubes. The atoms are stored in a coated bulb located within a cavity. The maser will oscillate provided certain conditions are met which relate to cavity- and line- $Q$ , particle flux, and device geometry. Limitations are cavity pulling (Table 1); and wall interaction due to the storage principle (Table 2).

(e) *Storage Beam Tube (Fig. 5)*. The hydrogen storage beam tube is a hybrid between the hydrogen storage beam maser and the traveling beam tube. The operation is analogous to beam tubes; however, the

hydrogen storage principle is adopted from the hydrogen maser. The direct flow of atoms from entrance to exit of the bulb must be prevented. A beam stop might be used, for example. The only serious limitation of this device is the wall shift (Table 2).

(f) *Optically Pumped Gas Cell (Figs. 6 and 7)*. Examples are the rubidium maser (Fig. 6) and the rubidium gas cell (Fig. 7). Their basic concepts are

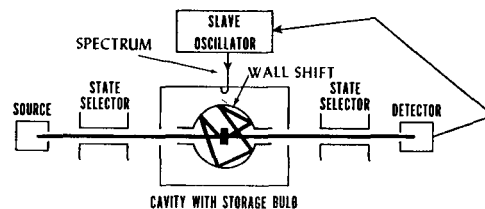

Fig. 5. Storage beam tube

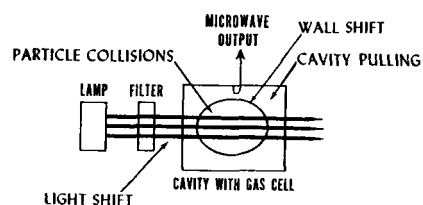

Fig. 6. Optically pumped gas cell maser

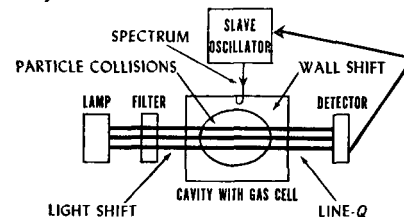

Fig. 7. Optically pumped passive gas cell

quite similar. A filtered light beam optically pumps the rubidium which is stored, together with buffer gases, in a cell within a cavity. The maser will start oscillations under certain conditions. The passive gas cell obtains the error signal for a slave oscillator from a photocell which monitors the transmission of light through the gas cell. Thus a method which was called frequency transformation in Table 1 is used here, since the optical transmissivity is a function of the microwave signal applied to the cavity. Limitations are cavity pulling (maser only) and the spectrum of the interrogating radiation (passive device only) (Table 1); particle collisions, wall interaction, and a relatively low line- $Q$  (Table 2); and the effects caused by the coupling of the clock transition to the optical pump transition which usually are called "light shifts" (Table 3).

(g) *Saturated Absorption* (Fig. 8). A gas cell is used which is irradiated by intense radiation from a laser which acts as the slave oscillator. Unique advantages of the saturation of an absorption are the significant reduction of the first order Doppler effect and the automatic exclusion from interrogation of most of the molecules which have suffered a collision. Known limitations are the spectrum of the laser radiation as well as photon effects of this radiation itself (Table 1); and particle collisions (Table 2).

(h) *Ion Storage Principle* (Fig. 9). Ions are confined by an inhomogeneous rf field, and can be stored for fairly long time periods. The confining field may be generated in a quadrupole trap consisting of a hyperbolic doughnutlike ring with hyperbolic caps on top

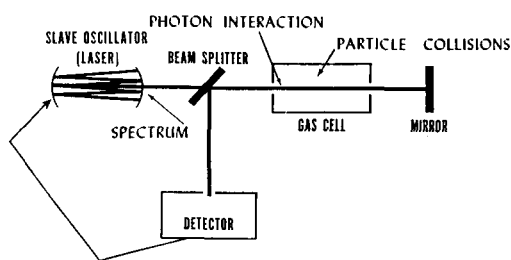

Fig. 8. Saturated absorption

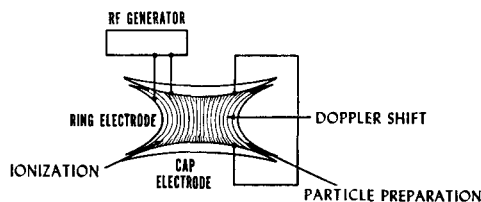

Fig. 9. Ion storage principle

and bottom<sup>5</sup>. Limitations are imposed by the necessity to ionize and by the method of particle preparation, which, so far, is usually spin exchange with an injected polarized atomic beam. Comments on this aspect were

already made in Section 3. The most severe limitation is the second order Doppler effect (Table 2).

## 6.6. FREQUENCY STABILITY FOR ONE SECOND AVERAGING

In the previous discussion we did not include the aspects of random uncertainty. These aspects can be described quantitatively by (1) through (4). In Table 4, an attempt at this is made for the different existing concepts, whereby we choose the best understood actual system in each case, e.g., we use the actual (NBS-III)<sup>1</sup> and projected (NBS-5)<sup>1</sup> performances of cesium laboratory standards in the case of the beam tube concept.

The first column lists  $n_s$ , the signal particle flux or the number of interrogated particles per second; the second column gives the interrogation time  $T_r$ . In the third column the figure of merit  $M$  is calculated from (2). With the transition frequencies, which are listed in the fourth column, we can calculate from (1), (3), and (4) the fractional stability for 1 sec averaging time. It must be emphasized that the values given for  $n_s$  and  $T_r$  and therefore for  $\sigma$  are only approximate and sometimes only "educated guesses." However, they may serve to give an approximate feeling for the potential stability performance of each technique. We also must note that the measured stability usually will be worse than the calculated stability because of limitations in the associated electronics, i.e., receiver or detector, slave oscillator, etc. For example the best actual performance of the hydrogen maser is  $\sigma(1s) \approx 8 \times 10^{-13}$  [45] ( $5 \times 10^{-13}$  [46]) and of the methane saturated absorption is  $\sigma(1s) \approx 2 \times 10^{-12}$  [20] ( $2 \times 10^{-13}$  [47]).

## 6.7. ACCURACY CAPABILITY

At the beginning of section 4 we pointed out the difficulty in quoting quantitative values for the various error sources which make up the accuracy capability. Nevertheless it is of interest to quote those accuracy capabilities which have been determined for actual systems based on experiments. They are listed in the

Table 4. Data on different concepts for primary frequency standards

	$n_s$ (s <sup>-1</sup> )	$T_r$ (s)	$M$ (s <sup>1/2</sup> )	$\nu$ (Hz)	$\sigma_y \equiv \frac{K}{M} \frac{1}{\sqrt{\tau}}$ ( $\tau = 1s$ )	Accuracy capability	
						Present experimental performance	Projected
Traveling beam tube (Cs)	$10^8$	$10^{-2}$	$10^2$	$9.2 \times 10^9$	$2 \times 10^{-13}$	$5 \times 10^{-13}$ [1]	$1 \times 10^{-13}$
Absorption in beam (I <sub>2</sub> )	$10^8$	$10^{-6}$	$10^{-2}$	$5.8 \times 10^{14}$	$3 \times 10^{-14}$	—	better than $10^{-12}$
Traveling beam maser (NH <sub>3</sub> )	$10^{13}$	$10^{-4}$	$3 \times 10^2$	$2.4 \times 10^{10}$	$5 \times 10^{-13}$	$10^{-11}$ [48]	$10^{-11}$
Storage beam maser (H)	$10^{12}$	1	$10^6$	$1.4 \times 10^9$	$10^{-14}$	$2 \times 10^{-12}$ [49]	better than $10^{-12}$
Storage beam tube (H)	$10^8$	1	$10^4$	$1.4 \times 10^9$	$10^{-14}$	—	better than $10^{-12}$
Optically pumped gas cell (Rb)	$10^{14}$	$10^{-2}$	$10^5$	$6.8 \times 10^9$	$10^{-14}$	$10^{-10}$	$10^{-10}$
Saturated absorption (CH <sub>4</sub> )	$10^{10}$	$10^{-5}$	1	$8.8 \times 10^{13}$	$2 \times 10^{-15}$	$10^{-11}$ [20]	better than $10^{-12}$
Ion storage ( <sup>3</sup> He <sup>+</sup> )	$10^5$	10	$3 \times 10^8$	$8.7 \times 10^9$	$10^{-14}$	$10^{-9}$ [34]	better than $10^{-12}$

<sup>5</sup> Several other trap configurations are possible.



fifth column of Table 4. There are no experimental data which would support accuracy capability claims for the beam absorption and the storage beam techniques. The last column in Table 4 depicts the projected performance which we consider possible from applying and evaluating the thoughts of Sections 1, 2, and 3 of this paper and from interpreting the experimental data. A comparison between the last two columns of Table 4 gives an approximate idea of the state of knowledge and development of each concept.

## 6.8. CONCLUSIONS

The (ammonia) travelling beam maser and the (rubidium) optically pumped gas cell have been studied quite extensively and their limitations are well known. The magnitude of the limitations, stated qualitatively in paragraphs (c) and (f) of Section 3, is such that we cannot expect any improvement in the accuracy capability in the foreseeable future as is indicated in Table 4. Their accuracy capability is also, in comparison, so marginal that they are not competitors in the contest for superior primary frequency standards.

The standard with the best accuracy capability at present is the cesium beam tube. The individual effects contributing to this accuracy capability are also comparatively well understood [1—5]. Therefore it is possible to predict that an accuracy capability of  $1 \times 10^{-13}$  may actually be realized in the foreseeable future [1]. The projected performances of the remaining concepts, which are listed in Table 4, are quoted as better than  $10^{-12}$ . Each of the limiting effects for these concepts, as discussed in the corresponding paragraphs of Section 4, has the possibility of being reduced to that level.

How far it will be possible to push beyond  $10^{-12}$  is quite difficult to predict. As a qualitative rule we may state that the magnitude of an error (bias uncertainty) will decrease when the corresponding bias correction is reduced. Also we may gain an advantage when we choose a concept which involves as few bias corrections as possible. Adopting this philosophy we can reexamine those devices listed in Table 4 which hold promise, and we can try to synthesize an optimum solution following the thoughts of Sections 1 to 3. It is evident that no single superior concept can be found. We have to compromise in order to arrive at a practical solution.

In Section 2 we pointed out that a passive technique should be preferred over an active oscillator (maser, laser), although it is difficult to give a fair judgment on all parameters involved. In this paper we are only concerned with "fundamental" limitations and it is conceded that technical and design aspects may well be more important than the fundamental ones. As an example, it remains to be proven experimentally that the detection of a hydrogen beam in the hydrogen storage beam device does not create sufficient technical problems to render its "fundamental" superiority over the hydrogen storage maser ineffective.

In the search for an optimum passive technique the frequency of the transition is an important parameter. A low frequency is of advantage in the interrogation of particles; however, effects caused by particle confinement are fractionally large, and it is necessary to prepare the particles for effective interrogation. The most effective method for particle preparation which also introduces no adverse effects, if proper care is taken, is spatial state selection of a particle beam. For particle confinement at low frequencies we have to rule out simple absorption. Storage in buffer gases introduces large biases and with it relatively large errors. A third method, ion storage, seems to be severely affected by the second order Doppler effect. A significant reduction of this bias (effective ion temperature) appears difficult and its knowledge to correspondingly better than  $10^{-13}$  seems to be a serious problem [50]. Technical difficulties associated with the creation, injection, and preparation of ions may also restrict the usage of ion storage as a method of confinement. However, it should not be considered experimentally impossible, especially if heavy ions are used which reduce adverse heating effects [51].

Two choices are left. The first is the traveling beam method, i.e., in practice an advanced cesium beam tube. The use of particles other than cesium will not give a substantial advantage. The prospects can be fairly well predicted (Table 4). The second choice is the storage beam tube. So far only atomic hydrogen can be stored effectively in a vessel with coated walls. The only limiting effect is the wall interaction (wall shift). At present the wall shift bias is typically of the order of  $10^{-11}$  and can be measured to about 10% [49]. Recent experiments show that the wall shift can actually be made zero at elevated temperatures [52, 53]. We also may assume that bulbs of variable size can be used to evaluate the wall shift with a higher degree of accuracy [54], and that considerably larger storage bulb sizes can be used [55]. If we assume that the wall shift bias could be reduced by one order of magnitude and could be measured to 1% of its value, we would have an accuracy capability of  $10^{-14}$ .

A high frequency transition eliminates most of the problems associated with particle confinement and preparation because we can use simple absorption. Specific problems and technical difficulties may arise in connection with the frequency multiplication and synthesis into the infrared region. We shall assume that these problems can be overcome. Confinement in an absorption cell is possible because the fractional influences of wall and particle collisions are reduced due to the high frequency. Saturated absorption [20] will further reduce adverse effects because only particles with near zero Doppler shift and near zero collisional effects are interrogated. Another choice is the use of a traveling beam [22] which absorbs radiation directed perpendicular to the beam. Effects related to the energy of the interrogating photons, e.g. recoil, can be a limitation which becomes more

pronounced as the transition frequency increases<sup>6</sup> [56]. Existing methods like the methane saturated absorption will allow a study of these effects and will give an indication of how well the bias can be determined or avoided. The fractional difference between the characteristic absorption and emission frequencies due to recoil is theoretically of the order of  $10^{-11}$  for methane.

Following these thoughts one may conclude that such effects are reduced by choosing a transition of lower frequency, e.g., in the far infrared, while still retaining the advantages of a relatively high transition frequency. The optimum frequency for such an approach appears to lie in the lower terahertz region. Here the opportunity for gaining full advantage from techniques based on simple absorption still exists (sufficient population and population difference even at thermal equilibrium, and optical techniques can be used), but the biases related to the energy of the interrogating photons are reduced. These effects can be reduced further and the interrogation time can be increased by using molecules of larger mass. Also the absorption in a traveling beam method should be considered more seriously. Thus accuracy capabilities of better than  $10^{-13}$  may be expected.

In summary we may conclude that among other possibilities the storage beam principle (hydrogen) holds high promise for a quantum electronic frequency standard based on a low (microwave) transition frequency. The other group of techniques which has a potential of competing with or surpassing the projected performance of the cesium beam tube is based on simple absorption in transitions of high frequency, in at least the terahertz region. Both approaches hold the promise for accuracy capabilities of  $10^{-14}$  and are within reach of experimental realization.

*Acknowledgements.* My paper is based on the work and thoughts of many during the past years as evidenced by the list of references which is by no means exhaustive. I gratefully acknowledge their input to this paper.

I owe special thanks to Donald Halford and John L. Hall who helped shape this paper in many fruitful discussions.

## 6.9. REFERENCES

1. Glaze, D. J.: Proc. of the XVI General Assembly of URSI, Ottawa, Canada, August 1969, entitled Progress in Radio Science, 1966—1969, to be published; also IEEE Trans. on Instrumentation and Measurement **IM-19**, 156 (1970).
2. Kartaschoff, P., Debély, P. E.: Proc. of the Colloque International de Chronométrie, p. A 3—1 (1969).
3. Becker, G., Fischer, B., Kramer, G., Müller, E. K.: Proc. of the Colloque International de Chronométrie, Paris, 1969, p. A 2—1.
4. — — — — PTB-Mitteilungen **2**, 77 (1969).
5. Mungall, A. G., Bailey, R., Daams, H., Morris, D.: Metrologia **4**, 165 (1968).
6. Hocker, L. O., Ramachandra Rao, D., Javan, A.: Phys. Letters **24** A, 690 (1967).
7. — Sokoloff, D. R., Daney, V., Szoke, A., Javan, A.: Appl. Phys. Letters **12**, 401 (1968).
8. Evenson, K. M., Wells, J. S., Mataresse, L. M.: Appl. Phys. Letters **16**, 251 (1970).
9. — — — — Elwell, L. B.: Appl. Phys. Letters **16**, 159 (1970).
10. Hocker, L. O., Small, J. G., Javan, A.: Phys. Letters **29** A, 321 (1969).
11. McCoubrey, A. O.: Proc. IEEE **54**, 116 (1966).
12. Lyons, H.: Ann. N.Y. Acad. Sci. **55**, 831 (1952).
13. Barrelland, H., Essen, L.: Sci. Prog. **47**, 209 (1959).
14. Mockler, R.: Advances in Electronics and Electron Phys. **15**, 1 (1961).
15. Beehler, R. E.: Proc. IEEE **55**, 792 (1967).
16. Shimoda, K., Wang, T. C., Townes, C. H.: Phys. Rev. **102**, 1308 (1956).
17. Davidovits, P., Novick, R.: Proc. IEEE **54**, 155 (1966).
18. Kleppner, K., Berg, H. C., Crampton, S. B., Ramsey, N. F., Vessot, R. F. C., Peters, H. E., Vanier, J.: Phys. Rev. **138**, A 972 (1965).
19. Peters, H. E., McGunigal, T. E., Johnson, E. H.: Proc. 23rd Annual Symposium on Frequency Control, Atlantic City, 1969, p. 297.
20. Barger, R. L., Hall, J. L.: Phys. Rev. Letters **22**, 4 (1969).
21. Hanes, G. R., Baird, K. M.: Metrologia **5**, 32 (1969).
22. Ezekiel, S., Weiss, R.: Phys. Rev. Letters **20**, 91 (1968).
23. Beehler, R. E., Mockler, R. C., Richardson, J. M.: Metrologia **1**, 114 (1965).
24. Lacey, R. F., Helgesson, A. L., Holloway, J. H.: Proc. IEEE **54**, 170 (1966).
25. Dehmelt, H. G.: Phys. Rev. **103**, 1125 (1956).
26. Cutler, L. S., Searle, C. L.: Proc. IEEE **54**, 136 (1966).
27. Hellwig, H.: Metrologia **6**, 56 (1970).
28. Halford, D., Wainwright, A. E., Barnes, J. A.: Proc. 22nd Annual Symposium on Frequency Control, Atlantic City, 1968, p. 340.
29. Holloway, J. H., Lacey, R. F.: Proc. of the Colloque International de Chronométrie, Lausanne, 1964, vol. 1, p. 317.
30. Shirley, J. H.: J. Appl. Physics **34**, 783 (1963).
31. Ramsey, N. F.: Rev. Sci. Instr. **28**, 57 (1957).
32. Kleppner, D., Ramsey, N. F., Fjelstadt, P.: Phys. Rev. Letters **1**, 232 (1958).
33. Dicke, R. H.: Phys. Rev. **89**, 472 (1953).
34. Fortson, E. N., Major, F. G., Dehmelt, H. G.: Phys. Rev. Letters **16**, 221 (1966).
35. Ramsey, N. F.: Molecular beams. Oxford: Clarendon 1956.
36. Bender, P. L., Beaty, E. C., Chi, A. R.: Phys. Rev. Letters **1**, 311 (1958).
37. Schwartz, C.: Ann. Physics **6**, 156 (1959).
38. Barnes, F. S.: IRE Trans. on Instrumentation **I-11**, 191 (1962).
39. Shimoda, K.: J. Phys. Soc. Japan **16**, 1728 (1961).
40. Arditi, M., Carver, T. R.: Proc. IEEE **51**, 190 (1963).
41. Bonanomi, J.: IRE Trans. on Instrumentation **I-11**, 212 (1962).
42. Beehler, R. E., Glaze, D. J.: IEEE Trans. on Instrumentation and Measurement **IM-15**, 55 (1966).
43. Rabinowitz, R., Keller, R., La Tourrette, J. T.: Appl. Phys. Letters **14**, 376 (1969).
44. Hellwig, H., McKnight, R., Pannaci, E., Wilson, G.: Proc. 22nd Annual Symposium on Frequency Control, Atlantic City, 1968, p. 529.
45. Vessot, R., Peters, H., Vanier, J., Beehler, R., Halford, D., Harrach, R., Allan, D., Glaze, D., Snider, C., Barnes, J., Cutler, L., Bodily, L.: IEEE Trans. on Instrumentation and Measurement **IM-15**, 165 (1966).
46. Peters, H. E.: Private communication.
47. Hall, J. L.: Private communication.
48. De Prins, J.: IRE Trans. on Instrumentation **I-11**, 200 (1962).
49. Hellwig, H., Vessot, R. F. C., Levine, M. W., Zitzewitz, P. W., Allan, D. W., Glaze, D. J.: Conference on Precision Electromagnetic Measurements, Boulder, Colorado (1970).

<sup>6</sup> The fractional influence for recoil is proportional to  $\nu$ .

- IEEE Trans. on Instrumentation and Measurement **IM-19**, 200 (1970).
50. Church, D., Dehmelt, H. G.: J. Appl. Phys. **40**, 3421 (1969).
51. Dehmelt, H. G.: Advances in Atomic and Molecular Physics **5**, 109 (1969).
52. Zitzewitz, P. W.: Proc. 24th Annual Symposium on Frequency Control (1970). To be published.
53. Vessot, R. F. C., Levine, M. W.: Proc. 24th Annual Symposium on Frequency Control (1970). To be published.
54. Debély, P.: Proc. 24th Annual Symposium on Frequency Control (1970). To be published.
55. Uzgiris, E. E., Ramsey, N. F.: Phys. Rev. A **1**, 429 (1970).
56. Kolchenko, A. P., Rautian, S. G., Sokolovskii, R. I.: Zh. Eksp. Teor. Fiz. **55**, 1864 (1968) (Engl. transl. in Soviet Phys. JETP **28**, 986 (1969)).

Contribution of the National Bureau of Standards, not subject to copyright. Presented at the 24th Annual Symposium on Frequency Control, Atlantic City, N.J., 27—29 April 1970.

Received June 17, 1970

*Offprint from "Metrologia"*  
*Journal International de Métrologie scientifique — International Journal of Scientific Metrology*  
*Internationale Zeitschrift für wissenschaftliche Metrologie. Vol. 6, No. 4, October 1970, Pages 118—126*

## CHAPTER 7

### ACCURATE FREQUENCY MEASUREMENTS: RELEVANCE TO SOME OTHER AREAS OF METROLOGY\*●

Helmut Hellwig† and Donald Halford†

#### Contents

	Page
7.1. Introduction.....	139
7.2. Accurate Frequency Measurements: Principles and Methods.....	140
7.2.1. Particle Beams.....	141
7.2.2. Storage of Particles.....	141
7.2.3. Saturated Absorption.....	142
7.3. Survey of Accurate Frequency Measurements.....	142
7.4. Significance and Impact of Accurate Frequency Measurements.....	144
7.5. Summary.....	145
7.6. References.....	146
7.7. Selected Bibliography: Future Trends in Accurate Frequency/Time Metrology.....	148

\*This chapter contains essentially the text of an original manuscript entitled "Accurate Frequency Measurements: Survey, Significance, and Forecast" which was published in *PRECISION MEASUREMENT AND FUNDAMENTAL CONSTANTS, Proceedings of the International Conference held at the National Bureau of Standards, Gaithersburg, Maryland, August 3-7, 1970, Nat. Bur. Stand. (U.S.) Spec. Publ. 343*, Edited by Langenberg, D. N., and Taylor, B. N., pp. 17-25 (USGPO, August 1971). We have made some modifications and have updated the material to late 1972 mainly through the use of footnotes.

●Manuscript received April 1, 1973.

†Time and Frequency Division, Institute for Basic Standards, National Bureau of Standards, Boulder, Colorado 80302.

"Time present and time past  
Are both perhaps present in time future,  
And time future contained in time past."

Thomas Stearns Eliot

Accurate frequency measurements in the microwave through the infrared regions as well as the imminent realization of accurate frequency measurements in the near infrared and visible regions are surveyed, and their significance on the system of basic standards and fundamental constants is discussed. An exceedingly accurate redetermination of the speed of light, and a single primary unified standard for frequency, time, and length are imminent possibilities. The further possibility of one primary standard for many (if not all) of the base units exists. Traditional beam techniques, storage methods, and infrared or visible radiation molecular absorptions appear as the most promising candidates for the primary (frequency) standard.

**Key words:** Cesium beam; frequency standards; frequency/time metrology; fundamental constants; International System of Units; length standards; speed of light; unified standard; units of measurements.

## 7.1. INTRODUCTION

The present International System of Units of Measurement (SI) is built on six base units<sup>1</sup> which are related—with one exception (mass)—to fundamental properties of nature: time, length, mass, temperature, electrical current, and luminous intensity<sup>2</sup> [1].<sup>3</sup> Of these the unit of time, or more exactly the unit of time interval, the second, has been in modern times the most accurately<sup>4</sup> known and internationally accepted unit. The simple reason for this is that we are provided by nature

with a unit of time interval: the duration of one day due to the rotation of the earth. Up to the recent past the definition of the second was based on the rotation of the earth and more recently on the revolution of the earth around the sun [2]. The accuracy of the second which can be realized by the definition approaches one part in  $10^9$  for extremely long observation periods (many years) [2, 3]. For shorter observation periods the accuracy is correspondingly worse. Figure 7.1 depicts the development of the accuracy capability of time interval standards since the advent of atomic clocks. Accuracy capability is here expressed as the one sigma combined uncertainty of all bias corrections. The bias corrections are the result of a theoretical and experimental evaluation of each particular standard, whose actual performance always deviates to some degree from the idealized conditions which are adopted in a definition of a base unit.

<sup>1</sup>In October 1971 the General Conference on Weights and Measures (CGPM) voted to adopt the mole as a base unit in the SI, thereby increasing the number of base units from six to seven (see footnote 2). The mole is a measure of the quantity of matter [59].

<sup>2</sup>Of these, only the first four are represented by independent primary base standards. See footnote 17.

<sup>3</sup>Figures in brackets indicate the literature references at the end of this chapter.

<sup>4</sup>By accuracy, we mean the degree to which a physical measurement or its measuring device conforms to a specified definition.

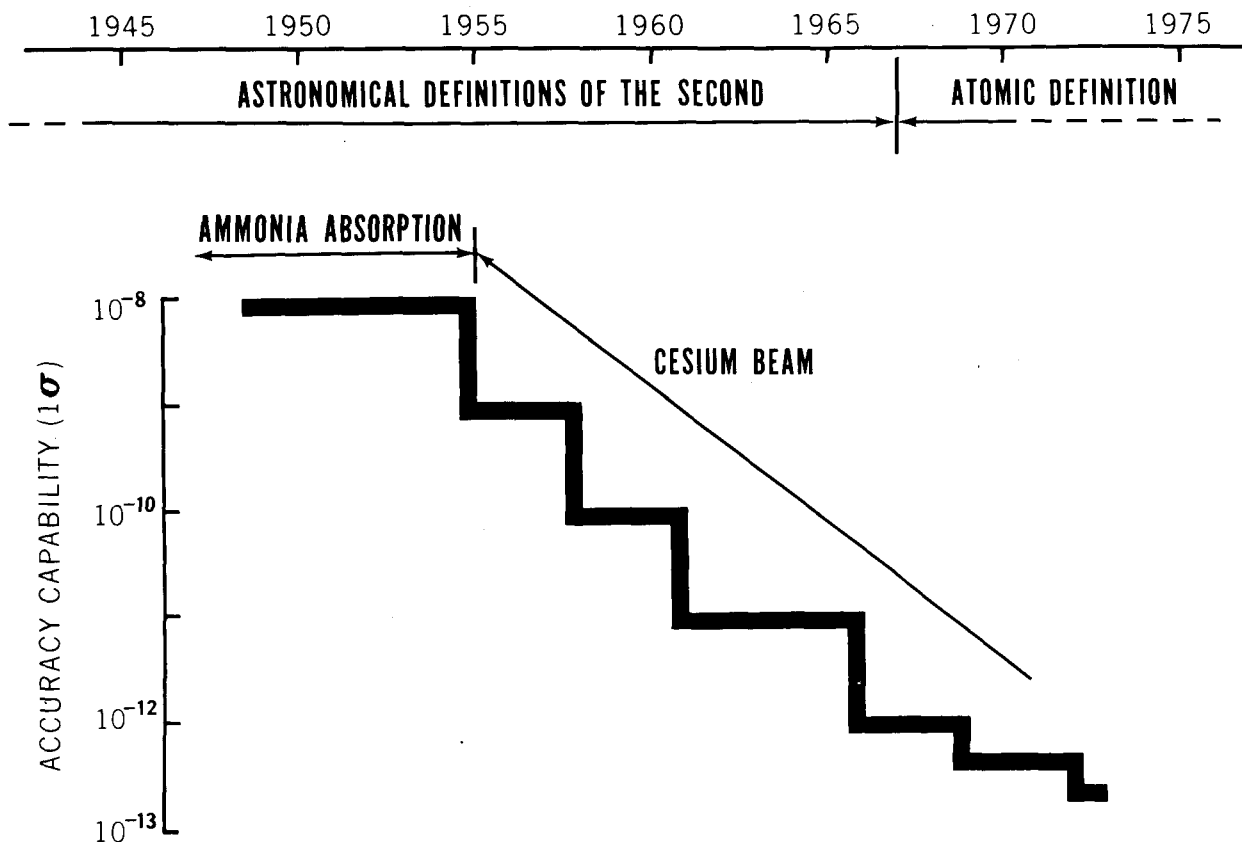

FIGURE 7.1. Historical development of the accuracy capability of the leading quantum electronic time interval/frequency standards, up to early 1973 (for recent values for time interval see ref. [70, 71]).

Figure 7.1 shows that the astronomical definition held its place exclusively until 1948. In that year the first ammonia clock was operated by H. Lyons at the National Bureau of Standards [4]. This clock's performance did not yet surpass that of the astronomical one. However, the advent of the ammonia clock is important for two reasons: Firstly, the unit of time interval could be related for the first time to an (assumed) invariant physical constant, here to the inversion transition in the ammonia molecule, instead of being based solely on the movements of macroscopic celestial bodies which are known to have secular changes (it is possible to correct for some but not all of the secular changes). Secondly, a frequency standard was used to aid in the definition of time interval; i.e., one used the relationship

$$\tau \equiv bv^{-1}, \quad (7.1)$$

and  $b \equiv 1$ , with  $\tau$  and  $\nu$  being the period and frequency of the radiation which is associated with the quantum transition. The unit of time interval, the second, can thus be defined as a certain number of periods of this radiation.<sup>5</sup>

A complete atomic clock system based on a hyperfine transition in cesium was operated and evaluated in 1955 by Essen at the National Physical Laboratory [5] and exceeded the performance of previous standards by one order of magnitude. As indicated in figure 7.1, further improvements in the cesium atomic clock at several laboratories around the world [3], [6-15] pushed its accuracy capability to its current value of better than  $10^{-12}$  [16-19]. This performance of cesium clocks led the 13th General Conference on Weights and Measures in 1967 to accept the following definition: "The second is the duration of 9 192 631 770 periods of the radiation corresponding to the transition between the two hyperfine levels of the ground state of the cesium-133 atom." The unit of frequency, the hertz, is then defined by eq (1) with  $b \equiv 1 \text{ Hz} \cdot \text{s}$ .

## 7.2. ACCURATE FREQUENCY MEASUREMENTS: PRINCIPLES AND METHODS

The base standard for time interval, the cesium atomic beam apparatus, is not only the most accurate frequency source, but also the most accurate of all base standards by a considerable margin as is illustrated in figure 7.2. This graph depicts the accuracy capability for all six (see footnote 1) units of the SI Base Units [1, 20]. The values for time, length, current, temperature, and luminous intensity describe the ability of actual instruments to realize the definition of the corresponding base unit. They

<sup>5</sup> There could be separate standards for time interval and for frequency. The constant  $b$  in eq (7.1) would then be a fundamental constant in a sense quite similar to the speed of light, and  $b$  would have the dimension  $\text{Hz} \cdot \text{s}$ .

### SI base units of measurement

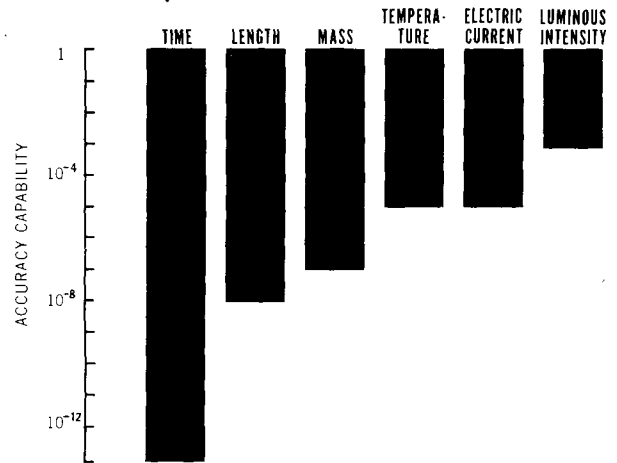

FIGURE 7.2. Comparison of the current accuracy in the realizations of the six base units of the International System of Units (SI) up to early 1973 rounded to orders of magnitude. (See footnote 1.)

were obtained from theoretical and experimental evaluations of bias corrections and from national and international intercomparisons. The only base unit which is still defined by an artifact is the kilogram. Here the accuracy capability is the ability to compare masses with this artifact and to preserve it unchanged. It must be noted that the precision<sup>6</sup> of relative measurements in any of these base units may be considerably better than the quoted accuracy capability of the corresponding base standards. In addition to being the most accurate kind, frequency/time metrology is the most precise of the many kinds of metrology (e.g., length, mass, force, pressure, resistance, current). Accurate and precise frequency measurements can be easily instrumented and can be highly automated. The versatility of frequency measurement techniques has led to their wide usage in metrology in general. Radio broadcasts of accurate frequency and time signals are available worldwide.

It is obvious from figure 7.2 that measurements which are based on time interval or frequency determinations have the potential of exceeding by far the accuracy of any measurement involving the five other base units (see footnote 1). Some physical constants can therefore be measured with extreme accuracy by using time interval and frequency methods. In particular this is true for the measurement of quantum transitions in atoms and molecules.

The availability of an exceedingly accurate standard is, however, only one prerequisite for an accurate measurement. In order to utilize the high accuracy capability of a time interval/frequency

<sup>6</sup> By precision, we mean here the reproducibility, within a set, of specified measurements taken as a time series.

standard, the system which is to be measured has to be brought under such experimental control that its measurement yields an accuracy which approaches that of the standard. In the limit, the system under study will have to show properties which are characteristics of a time interval/frequency standard itself. Therefore, the very systems which yield the most accurate measurements are simultaneously candidates for new time interval/frequency standards. We will discuss this aspect later in this chapter.

A system intended for the measurement of a transition frequency of an atom or molecule involves several steps of physical and technical processing which lead to bias corrections and corresponding uncertainties. These steps can be classified into three groups: (1) particle preparation, (2) particle confinement, and (3) particle interrogation [21].

There is no fundamental necessity to prepare the particles. However, often it is desirable to select only certain energy states or to achieve a desired population distribution of the energy levels. This can be done by spatial state selection, optical pumping, etc. Care must be taken to minimize perturbing effects.

A fundamental aim of precise measurements is an observation time as large as possible. Particle confinement is used to achieve coherent interaction times between the particles and the interrogating radiation which are as long as possible without introducing undue perturbations or excessive loss of signal. The confinement technique also is of considerable importance in the reduction of the Doppler effect, which is the most severe limitation in simple gas cell absorption measurements. Various confinement techniques such as a storage vessel with coated walls, ion storage, the storage in a cell filled with buffer gases, or the traveling particle beam are possible.

The particles have to be interrogated. Usually a resonant structure (e.g., cavity or interferometer) is used to enhance the interaction and to provide a spatially well-defined interaction region. The interrogation process itself may introduce perturbations such as the Bloch-Siegert effect [22] and photon recoil [21, 23].

We will now discuss the three methods<sup>7</sup> which stand out as leading to the most accurate measurements. It is not surprising that all three have in common a significant reduction of the Doppler effect limitation.

### 7.2.1. Particle Beams

In a particle beam apparatus, particles emerge from a source, forming a beam which travels through vacuum as indicated in figure 7.3. A polarizer (spatial state selector, optical pump, . . .) creates a certain, more desirable population distribution of

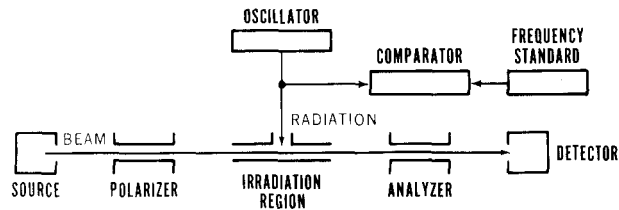

FIGURE 7.3. Accurate frequency measurements: particle beam method.

the energy levels. The beam then enters the region of interrogation and is "confined" there for the duration of the transit time. The interrogation by radiation of suitable intensity and a suitable frequency which is compared to the frequency standard results in a change of the population distribution and a change of the intensity of the transmitted or reflected radiation. Two modes of detection are therefore possible. One is the analysis of the population distribution by counting the number of particles in a selected energy state. An analyzer, similar to the polarizer, and a particle detector are then necessary. An example of this mode of detection is shown in figure 7.3 [24]. The other mode of detection, which is not shown in figure 7.3, involves the monitoring of the radiation intensity [25, 26]. Under certain conditions, particularly at sufficiently high beam intensity, the system converts to a frequency generator (maser, laser oscillator) [25]. The output frequency is then detected and measured by comparison with a frequency standard.

In the particle beam the Doppler effect is greatly reduced by the narrow, unidirectional beam. If care is taken in the design of the resonance structure so that the beam does not encounter net radiation power traveling parallel to the beam direction, the limitations due to the first-order Doppler effect can be virtually eliminated [24]. The second-order Doppler effect can be measured, or can be calculated, if the particle speed is adequately known. Particle preparation does not introduce frequency bias if it is spatially separated from the interrogation region.

### 7.2.2. Storage of Particles

In a storage device, particles are stored in a vessel which is located within the resonance structure as shown in figure 7.4. Particle preparation may be done simultaneously with the interrogation, e.g., by optical pumping and monitoring the intensity of the transmitted pump radiation as indicated in figure 7.4 [27]. However, this introduces frequency shifts which are difficult to evaluate [28].

<sup>7</sup>A more detailed discussion of these methods is given in Chapter 6.



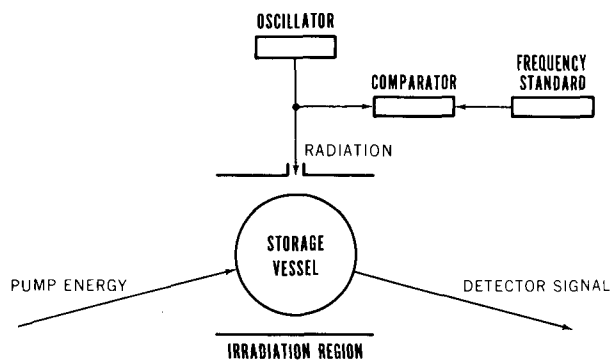

FIGURE 7.4. Accurate frequency measurements: particle storage method.

It is therefore advantageous to separate the preparation and interrogation regions and to use the storage principle in connection with the polarizing and analyzing technique of figure 7.3. In other words, the storage device of figure 7.4 is inserted between polarizer and analyzer of the system in figure 7.3 thus forming a storage beam device [29, 30]. Again we have the option to adjust the system parameters (beam intensity, pumping strength, . . .) such that self-oscillations are possible [28, 31].

The advantage of the storage technique is the increase in the confinement time leading to a very sharp line. The first-order Doppler effect also can be virtually eliminated if the movement of the particles is confined to a region of less than half the wavelength of the interrogating radiation. This is easy for the case of microwave frequencies but is more difficult at very short wavelengths. However, buffer gases can sufficiently restrict the particle movements. Also, buffer gases [28] and coating of the walls of the storage vessel [31] are used to reduce frequency shifts and relaxation processes due to wall collisions. The second-order Doppler shift can be calculated to a high degree of accuracy from the temperature of the storage vessel since the kinetic energy of the stored particles is in thermal equilibrium with the storage vessel.

### 7.2.3. Saturated Absorption

As shown in figure 7.5, in a saturated absorption device, the radiation of an oscillator is passed in opposite directions through a cell which is filled with the particles under study. The transmitted radiation intensity is monitored. Those particles with a near-zero velocity component parallel to the radiation propagation vector experience a nonlinear, enhanced interaction with the radiation field ("Lamb dip") [32, 33]. The system parameters can be adjusted so that those particles which have a significant velocity component parallel to the radiation beam are not interrogated. This reduces con-

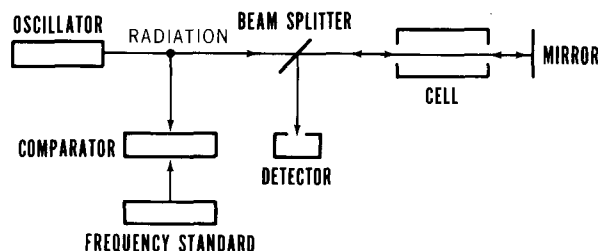

FIGURE 7.5. Accurate frequency measurements: saturated absorption method.

siderably the first-order Doppler effect and also excludes from the interrogation most of the particles which suffered a collision with other particles.<sup>8</sup> The line width is thus ultimately given by the transit time of particles across the radiation beam. The second-order Doppler correction can be obtained from the gas cell temperature. At higher frequencies the saturated absorption method may be limited by photon recoil effects which cause the emitted frequency  $\nu_E$  to be different from the absorbed frequency  $\nu_A$  by the fractional amount [21, 23]

$$(\nu_A - \nu_E)/\nu = h\nu/mc^2, \quad (7.2)$$

where  $\nu$  is the average of  $\nu_A$  and  $\nu_E$ ,  $m$  is the mass of the particle,  $h$  is Planck's constant, and  $c$  is the speed of light.

## 7.3. SURVEY OF ACCURATE FREQUENCY MEASUREMENTS

For figure 7.6 we have selected the most significant of the many published accurate frequency measurements and have plotted the published one sigma accuracy versus the location of the transition in the electromagnetic spectrum. The dashed bar in the case of  $I_2$  indicates that its frequency has not yet been measured.<sup>9</sup> This is because frequency synthesis<sup>10</sup> has not yet succeeded in reaching to this frequency. However, advances by several groups, in particular by K. Evenson of NBS [34] and A. Javan of MIT [35], indicate that success is immi-

<sup>8</sup> Particle collisions lead to changes in particle speed and direction. A strong collision removes the particle from the interrogation process because the collision introduces, with high probability, a significant velocity component parallel to the radiation beam.

<sup>9</sup> The first measurement by frequency metrology of the 88 THz frequency of  $CH_4$  was achieved on 11 November 1971 at NBS [60]. In 1972, the accuracy of the frequency measurement was improved to 6 parts in  $10^{10}$  yielding 88.376 181 627 THz [61]. As of late 1972, the 474 THz frequency of  $I_2$  has not yet been measured by frequency metrology, although the frequency is being determined via length metrology (unpublished work of H. Leyer and R. D. Deslattes). To the best of our knowledge, the highest frequency yet synthesized from the frequency of cesium is 177 THz (unpublished work of G. W. Day and H. Hellwig).

<sup>10</sup> For a survey of infrared frequency synthesis, see reference [62].

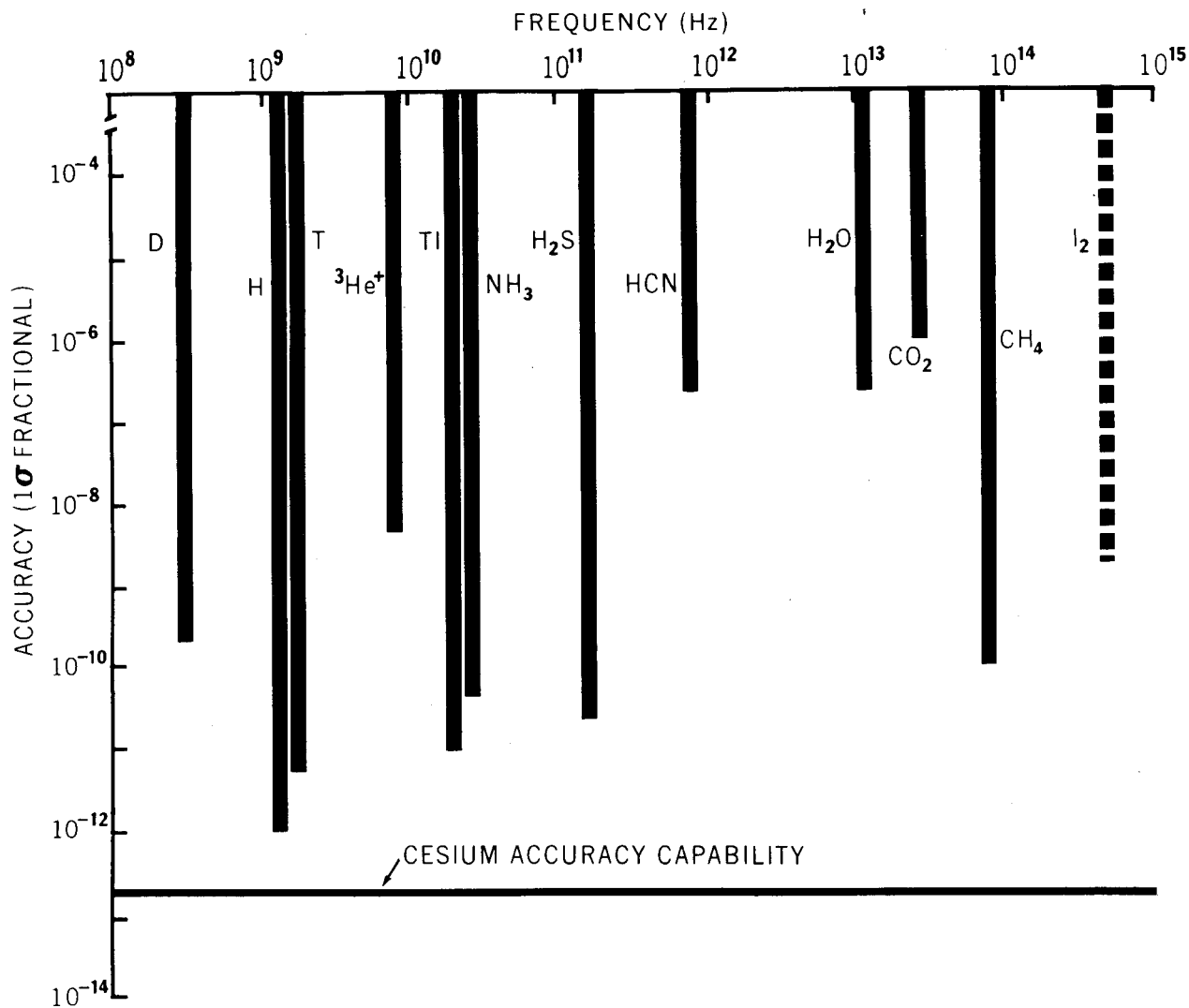

FIGURE 7.6. A survey of selected accurate frequency measurements throughout the electromagnetic spectrum. The accuracies reflect the state of the art as of early 1973. For  $I_2$  the anticipated value is indicated (see text).

ment.<sup>9</sup> The value indicated for the accuracy of the anticipated measurement of  $I_2$  is based on the evaluation of the beat frequency between two lasers which were independently frequency-locked to the  $I_2$  transition together with absolute wavelength measurements [33]. Table 7.1 contains information supplementary to figure 7.6.

The measurements of HCN,  $H_2O$ , and  $CO_2$  were made by frequency multiplication in a metal-metal point contact diode. The comparatively low accuracy of these values is due mainly to the fact that the molecular transition was investigated in a laser oscillator. This technique introduces large uncertainties because of Doppler effects, pressure effects, resonator frequency pulling, etc. Application of the saturated absorption method would considerably increase the measurement accuracy as is demonstrated by the  $CH_4$  and  $I_2$  experiments.

The storage of ions is a powerful and very promising spectroscopic tool as is demonstrated by the  $^3He^+$  measurement. However, several experimental parameters are not yet fully understood, and they need further investigation, especially the kinetic energy of the stored ions (Doppler effect) [36].<sup>11</sup>

The methods on which the most accurate measurements are based were already discussed. They are the saturated absorption ( $CH_4$ ,  $I_2$ ), the storage vessel (H, D, T), and particle beams (TI,  $NH_3$ ,  $H_2S$ , Cs). The cesium particle beam tube serves as the primary standard for the base unit of time interval and frequency. It has been the most accurate measuring device since 1955 (fig. 7.1). Its present accuracy capability, shown as the horizontal line across the bottom of figure 7.6, is 2 parts in  $10^{13}$  [15, 17, 18, 19, 70, 71 (see chap. 5B)].

<sup>11</sup> References [63] and [64] give discussions of the ion storage techniques as related to frequency standards.

TABLE 7.1. Survey of accurate frequency measurements

Particle	Transition	Technique	Frequency <sup>a</sup>	Accuracy	References
D	$F, m_F = \frac{3}{2}, \frac{1}{2} \leftrightarrow \frac{1}{2}, -\frac{1}{2}$	Storage maser	327 384 352.51 Hz	$2 \times 10^{-10}$	[37].
H	$F, m_F = 1, 0 \leftrightarrow 0, 0$	Storage maser	1 420 405 751.768 Hz	$1 \times 10^{-12}$	[38], [39].
T	$F, m_F = 1, 0 \leftrightarrow 0, 0$	Storage maser	1 516 701 470.809 Hz	$5 \times 10^{-12}$	[40].
<sup>3</sup> He <sup>+</sup>	$F, m_F = 0, 0 \leftrightarrow 1, 0$	Ion storage	8 665 649 905 Hz	$6 \times 10^{-9}$	[41].
<sup>205</sup> Tl	$F, m_F = 1, 0 \leftrightarrow 0, 0$	Particle beam	21 310 833 945.9 Hz	$1 \times 10^{-11}$	[42], [43].
<sup>15</sup> NH <sub>3</sub>	$J, K = 3, 3$ inversion	Beam maser	22 789 421 731 Hz	$5 \times 10^{-11}$	[44].
H <sub>2</sub> <sup>32</sup> S	$1_{-1} \leftrightarrow 1_1$	Particle beam	168 762 762 373 Hz	$2 \times 10^{-10}$	[45].
H <sup>12</sup> C <sup>14</sup> N	$110 \leftrightarrow 040$	Laser	0.890 7606 THz	$2 \times 10^{-7}$	[46], [47].
H <sub>2</sub> <sup>16</sup> O <sup>b</sup>	$001 \leftrightarrow 020$	Laser	10.718 073 THz	$2 \times 10^{-7}$	[47].
<sup>12</sup> C <sup>16</sup> O <sub>2</sub>	$P(18), 001 \leftrightarrow 100$	Laser	28.359 800 THz	$1 \times 10^{-6}$	[34].
<sup>12</sup> C <sup>16</sup> O <sub>2</sub>	$R(12), 001 \leftrightarrow 020$	Laser	32.176 085 THz	$6 \times 10^{-7}$	[50].
<sup>12</sup> CH <sub>4</sub>	$P(7), \nu_3$ band	Saturated absorption	$\approx 88$ THz	$(1 \times 10^{-11})$	[32].
I <sub>2</sub>	$R(127), 11-5$ band of electr. trans. $B^3\Pi_{or}^+ \leftrightarrow X^1\Sigma_{ou}^+$	Saturated absorption	$\approx 474$ THz	$(2 \times 10^{-9})$	[33].

<sup>a</sup> By definition,  $\nu_{Cs} \equiv 9\,192\,631\,770$  Hz. See text for recent results on CH<sub>4</sub>.

<sup>b</sup> The frequencies of several other transitions in water vapor lasers have been measured such as the 2.5-THz (118  $\mu$ m) line in H<sub>2</sub>O [48] and the 3.6-THz (84  $\mu$ m) line in D<sub>2</sub>O [49].

## 7.4 SIGNIFICANCE AND IMPACT OF ACCURATE FREQUENCY MEASUREMENTS

We can identify four general areas where accurate frequency measurements are significant and where some impact on future scientific and technological developments is foreseen. These are summarized in table 7.2. Within the scope of this chapter only the last area, fundamental constants and basic standards, is of importance; we will discuss it in detail and only briefly explain the first three items.

Metrology and applications include radar ranging especially over long (planetary) distances; planetary exploration in general; earth and space navigation, where timekeeping over weeks, months, or even years without resynchronization is vital; telecommunication aspects including high bit rates and better usage of the electromagnetic spectrum; and aircraft collision avoidance systems which can be based, perhaps with advantage, on time domain techniques which employ accurate clocks.

Accurate frequency measurements throughout the infrared and visible region will greatly increase our knowledge of the structure of atoms and molecules. Spectroscopic constants such as transition frequencies,  $g$ -factors, Stark coefficients, rotational distortions, etc., will be accessible to measurements of unprecedented precision and accuracy.

Tests of the general theory of relativity involving differences of coordinate time and frequency at locations of different gravitational potential will be made with clocks placed in satellites or on other celestial bodies. An improvement in accuracy of about one order of magnitude over our present accuracy capability will permit some tests to be conducted on the earth's surface.

TABLE 7.2. Areas of impact

Metrology and Applications to Technology
Spectroscopic Constants
General Theory of Relativity
Fundamental Constants and Basic Standards

The ability to perform accurate frequency measurements throughout the electromagnetic spectrum may have a considerable impact on the system of fundamental constants and basic standards. Figure 7.6 illustrates that frequency measurements have already been made in the terahertz region and that the ability to compare directly the frequencies of the standard of time interval/frequency (currently <sup>133</sup>Cs) and of the standard of length (currently <sup>86</sup>Kr) will soon be a reality.<sup>12</sup> The relationship between these standards involves the speed of light  $c$ ,

$$\lambda = c\nu^{-1}, \quad (7.3)$$

where  $\lambda$  is the vacuum wavelength and  $\nu$  is the frequency of the radiation. Equation (7.3), as applied to the direct comparison of length and frequency (time interval), will lead to a determination of the speed of light with unprecedented accuracy [34], which will be limited only by the ability to perform an interferometric length measurement (compare fig. 7.2).<sup>12</sup>

<sup>12</sup> This has been partially achieved in 1972. See reference [61].

Equation (7.3) is not the only "simple" relationship between basic standards involving a fundamental constant. The Josephson phenomenon [51] provides us with a relationship between the electrical potential difference  $V$  (relating to the standard of electrical current) across a superconducting weak link and the corresponding Josephson oscillation frequency  $\nu$

$$V = (h/2e)\nu. \quad (7.4)$$

Equation (7.4) has already served to determine Planck's constant  $h$  divided by the electronic charge  $e$  with unprecedented accuracy [52, 53] which led to a refitting of the whole system of fundamental constants [54].<sup>13</sup> We can imagine further simple relationships between basic standards and the time interval/frequency standard involving fundamental constants, such as a relationship for the mass  $m$

$$m = f(\nu), \quad (7.5)$$

or for the temperature<sup>14</sup>  $T$

$$T = g(\nu). \quad (7.6)$$

Accurate frequency measurements based on eqs (7.3) to (7.6) could therefore lead to a more accurate knowledge of the fundamental constants. This increased accuracy in turn would allow a more sensitive search for possible spatial and secular variations of the fundamental constants [55].

It is a consequence of historical development and experimental expertise that we have a set of base units and corresponding standards such as the SI; no fundamental physical principle is involved in this choice. It is already possible to compare spectroscopic data in the infrared or visible regions using frequency measurement techniques with a precision far exceeding that of interferometric (length measurement) techniques.

In view of the success of frequency multiplication from the microwave region into the infrared region and its imminent extension into the visible region it seems to be in order to question, at least philosophically, the need for a separate standard of length. Length measurements could be related to the base unit for time interval and frequency via eq (7.3). The speed of light would then be a defined constant<sup>15</sup> [56, 57, 58]. The defined value of  $c$  would be chosen to be compatible with its previous best experimental value, and the most accurate frequency standard would serve as a *Unified Standard* for frequency, time, and length.<sup>16</sup>

<sup>13</sup> It is now possible with the Josephson junction to create an operational substitute for the traditional bank of saturated cells used to maintain the NBS calibrated secondary working voltage standard ("Legal Volt"). Such an operational system was formally established in NBS on 1 July 1972 [65].

<sup>14</sup> Such a relationship has been used recently for temperature measurements in the millikelvin range [66, 67]. The method is based on the measurement of frequency fluctuations in a Josephson junction caused by voltage fluctuations which in turn are caused by thermal noise corresponding to the temperature of a resistor shunting the junction.

<sup>15</sup> Compare with footnote 5.

<sup>16</sup> These considerations are discussed in more detail in reference [68].

In the limit this philosophy would lead to a base set of fundamental constants with defined values. The most accurate standard, which is today the cesium beam frequency standard, would then serve as *The Standard*, and all other units of measurement could be derived using relationships such as eqs (7.3) to (7.6) with  $c$ ,  $h/(2e)$ , and some yet undetermined function like  $f(\nu)$  and  $g(\nu)$  (see footnote 14) as defined entities.<sup>17</sup> These possibilities add excitement to the work which is being done on frequency standards.

## 7.5. SUMMARY

In the preceding sections, we pointed out that frequency/time metrology is currently the most precise and accurate kind of metrology, and we outlined the significance of accurate frequency measurements and their impact on technology and physics, and in particular on the system of fundamental constants and basic standards. Possibly being the *Unified Standard* or even *The Standard* in some future system of units of measurement, the primary frequency standard should get special attention. At present we see several ways [21] of pushing its accuracy capability beyond the present one sigma performance of  $2 \times 10^{-13}$  of the laboratory cesium beam tube [70, 71].

We discussed the three most promising methods which allow the most accurate frequency measurements: particle beam, particle storage, and saturated absorption. We also mentioned that naturally these very same methods are the most promising ones for the development of future standards of even better accuracy.

In table 7.3, experimental realizations of these methods are listed together with evaluated accuracy capabilities and projected performances. Each projected performance is listed as better than some quoted value. This value is believed to represent a minimum performance which almost certainly can be surpassed based on our present experimental and theoretical knowledge; however, we cannot predict with sureness if and by how far. In this sense, a technique quoted as "better than  $10^{-11}$ " could well surpass one quoted as "better than  $10^{-12}$ ." For a more detailed discussion we recommend the cited literature, and we suggest reference [21] for a critical comparison and prognostic.

Perhaps a uniquely superior method of accurate frequency measurement will be singled out by additional experimental and theoretical work, or perhaps these three methods will each improve significantly so as to remain mutually competitive. Very likely, in the continuing progress of knowledge and technical abilities, new possibilities will continue to appear.

<sup>17</sup> Although there are seven base units in the SI (see footnote 1), there are at present only four independent primary base standards in the SI [69]: water for temperature (kelvin), prototype kilogram for mass (kilogram), atomic krypton for length (meter), and atomic cesium for time (second). Consequently, to go from four independent primary base standards to only one (*The Standard*) would require adoption of a suitable set of three such definitions, one of which would be the value of the round trip speed of light  $c$ .

TABLE 7.3. Promising candidates for primary frequency standards

Method	Device	$\nu$ (Hz)	Accuracy capability (one sigma)	
			Present performance	Projected performance
Particle beam.....	Cesium beam.....	$9.2 \times 10^9$	$2 \times 10^{-13}$ [70, 71]	Better than $10^{-13}$ .
	Iodine beam.....	$5.8 \times 10^{14}$	..... [26]	Better than $10^{-12}$ .
Particle storage.....	(Hydrogen Maser.....)	$1.4 \times 10^9$	$1 \times 10^{-12}$ [38]	Better than $10^{-12}$ .
	Hydrogen storage beam.....	$1.4 \times 10^9$	..... [30]	Better than $10^{-12}$ .
	( $^3\text{He}^+$ Ion storage (or heavy ions).....)	$8.7 \times 10^9$	$6 \times 10^{-9}$ [27]	Better than $10^{-11}$ .
Saturated absorption.....	(Methane cell.....)	$8.8 \times 10^{13}$	$1 \times 10^{-11}$ [32]	Better than $10^{-12}$ .
	Iodine cell.....	$4.7 \times 10^{14}$	$2 \times 10^{-9}$ [33]	Better than $10^{-11}$ .

## 7.6. REFERENCES

- [1] Terrien, J., "Scientific metrology on the international plane and the Bureau International des Poids et Mesures," *Metrologia*, **1**, No. 1, pp. 15-26 (January 1965).
- [2] Kovalevsky, J., "Astronomical time," *Metrologia*, **1**, No. 4, pp. 169-179 (October 1965).
- [3] Markowitz, W., Hall, R. G., Essen, L., and Parry, J. V. L., "Frequency of caesium in terms of ephemeris time," *Phys. Rev. Lett.*, **1**, No. 3, pp. 105-106 (August 1, 1958).
- [4] Lyons, H., "Spectral lines as frequency standards," *Annals of The New York Acad. of Sci.*, **55**, Art. 5, pp. 831-871 (November 1952).
- [5] Essen, L., and Parry, J. V. L., "An atomic standard of frequency and time interval," *Nature*, **196**, No. 4475, pp. 280-282 (August 13, 1955).
- [6] Kalra, S., Bailey, R., and Daams, H., "Cesium beam standard of frequency," *Canadian J. Phys. (Lett.)*, **36**, No. 10, pp. 1442-1443 (October 1958).
- [7] Mainberger, W., "Primary frequency standard using resonant cesium," *Electronics*, **31**, No. 45, pp. 80-85 (November 7, 1958).
- [8] McCoubrey, A., "Results of comparison: Atomichron—British cesium beam standard" (Summary), *Proc. 12th Ann. Symp. on Frequency Control* (U.S. Army Signal Research and Develop. Lab., Ft. Monmouth, NJ, 07703, May 6-8, 1958), p. 648 (NTIS, AD 298 324, 1958).
- [9] Kartaschoff, P., Bonanomi, J., and DePrins, J., "Etalons de frequence au cesium, description et resultats" (Cesium standards of frequency, descriptions, and results), *Helv. Phys. Acta*, **33**, No. 9, pp. 968-973 (September 1960) (in French).
- [10] Kartaschoff, P., "Operation and improvements of a cesium beam standard having 4-meter interaction length," *IRE Trans. on Instrum.*, **IM-11**, Nos 3 and 4, pp. 224-230 (December 1962).
- [11] Beehler, R. E., and Glaze, D. J., "The performance and capability of cesium beam frequency standards at the National Bureau of Standards," *IEEE Trans. on Instrum. and Meas.*, **IM-15**, Nos. 1 and 2, pp. 48-55 (March and June 1966).
- [12] Mungall, A. G., Bailey, R., and Daams, H., "The Canadian cesium beam frequency standard," *Metrologia*, **2**, No. 3, pp. 97-104 (July 1966).
- [13] Bodily, L., Hartke, D., and Hyatt, R., "Worldwide time synchronization," *Hewlett-Packard J.*, **17**, No. 12, pp. 13-20 (HP, Palo Alto, CA 94304, August 1966).
- [14] Vessot, R., Peters, H., Vanier, J., Beehler, R., Halford, D., Harrach, R., Allan, D., Glaze, D., Snider, C., Barnes, J., Cutler, L., and Bodily, L., "An intercomparison of hydrogen and cesium frequency standards," *IEEE Trans. on Instrum. and Meas.*, **IM-15**, No. 4, pp. 165-176 (December 1966).
- [15] Mungall, A. G., Bailey, R., Daams, H., and Morris, D., "A re-evaluation of the N.R.C. long cesium beam frequency standard," *Metrologia*, **4**, No. 4, pp. 165-168 (October 1968).
- [16] Kartaschoff, P., and Debély, P. E., "Resonateur a cesium de conception nouvelle" (New concepts of a cesium resonator), *Proc. Colloque Int. de Chronométrie* (Paris, France, September 16-20, 1969), Ser. A, Paper A3, 18 pp. (Nouvelle Faculte des Sciences 11, Quai St., Paris (5<sup>e</sup>) France, 1969) (in French).
- [17] Becker, G., Fischer, B., Kramer, G., and Müller, E. K., "Diskussion der Inneren Unsicherheit des Neuen Cäsium strahl-Zeitnormal der Physikalisch-Technischen Bundesanstalt" (Discussion of the internal uncertainties of the new cesium beam time standard of the PTB), *Proc. Colloque Int. de Chronométrie* (Paris, France, September 16-20, 1969), Ser. A, Paper A2, 9 pp. (Nouvelle Faculte des Sciences 11, Quai St., Paris (5<sup>e</sup>) France, 1969) (in German).
- [18] Becker, G., Fischer, B., Kramer, G., and Müller, E. K., "Neuentwicklung einer Cäsiumstrahlapparatur als Primäres Zeit- und Frequenznormal an der Physikalisch-Technischen Bundesanstalt" (New development of a cesium beam apparatus as a primary time and frequency standard at the PTB), *PTB-Mitt.*, **79**, No. 2, pp. 77-80 (April 1969).
- [19] Glaze, D. J., "Improvements in atomic cesium beam frequency standards at the National Bureau of Standards," *IEEE Trans. on Instrum. and Meas.*, **IM-19**, No. 3, pp. 156-160 (August 1970); *Progress in Radio Science 1966-1969—Part 1*, *Proc. XVI Gen. Assem. of URSI, Comm. 1* (Ottawa, Canada, August 18-28, 1969), J. A. Lane, J. W. Findlay, and C. E. White, Eds., pp. 331-341 (URSI, Brussels, Belgium, 1971) (see chap. 5A).
- [20] Terrien, J., "News from the International Bureau of Weights and Measures—The 54th meeting of the Comité International des Poids et Mesures," *Metrologia*, **1**, No. 1, pp. 55-56 (January 1966).
- [21] Hellwig, H., "Areas of promise for the development of future primary frequency standards," *Metrologia*, **6**, No. 4, pp. 118-126 (October 1970) (see chap. 6).
- [22] Shirley, J. H., "Some causes of resonant frequency shifts in atomic beam machines," *J. Appl. Phys.*, **34**, No. 4, Part I—"Shifts due to other frequencies of excitation," pp. 783-788; Part II—"The effect of slow frequency modulation on the Ramsey line shape," pp. 789-791 (April 1963).
- [23] Kolchenko, A. P., Rautian, S. G., and Sokolovskii, R. I., "Interaction of an atom with a strong electromagnetic field with the recoil effect taken into consideration," *Zh. Eksp. Teor. Fiz.*, **55**, pp. 1864-1873 (November 1968);

- English trans. *Soviet Phys. JETP*, **28**, No. 5, pp. 986–990 (Amer. Inst. Phys. Inc., New York, NY 10017, May 1969).
- [24] Ramsey, N. F., *Molecular beams* (Clarendon Press, Oxford, England, 1956).
- [25] Shimoda, K., Wang, T. C., and Townes, C. H., "Further aspects of the theory of the maser," *Phys. Rev.*, **102**, No. 5, pp. 1308–1321 (June 1956).
- [26] Ezekiel, S., and Weiss, R., "Laser-induced fluorescence in a molecular beam of iodine," *Phys. Rev. Lett.*, **20**, No. 3, pp. 91–93 (January 15, 1968).
- [27] Dehmelt, H. G., "Paramagnetic resonance reorientation of atoms and ions aligned by electron impact," *Phys. Rev. (Lett.)*, **103**, No. 4, pp. 1125–1126 (August 15, 1956).
- [28] Davidovitz, P., and Novick, R., "The optically pumped rubidium maser," *Proc. IEEE*, **54**, No. 2, pp. 155–170 (February 1966).
- [29] Kleppner, D., Ramsey, N. F., and Fjelstad, P., "Broken atomic beam resonance experiment," *Phys. Rev. Lett.*, **1**, No. 7, pp. 232–233 (October 1, 1958).
- [30] Hellwig, H., "The hydrogen storage beam tube—a proposal for a new frequency standard," *Metrologia*, **6**, No. 2, pp. 56–60 (April 1970).
- [31] Kleppner, D., Berg, H. C., Crampton, S. B., Ramsey, N. F., Vessot, R. F. C., Peters, H. E., and Vanier, J., "Hydrogen maser principles and techniques," *Phys. Rev.*, **138**, No. 4A, pp. A972–A983 (May 17, 1965).
- [32] Barger, R. L., and Hall, J. L., "Pressure shift and broadening of methane line at  $3.39 \mu$  studied by laser-saturated molecular absorption," *Phys. Rev. Lett.*, **22**, No. 1, pp. 4–8 (January 6, 1969).
- [33] Hanes, G. R., and Baird, K. M., " $I_2$  controlled He-Ne laser at 633 nm: preliminary wavelength," *Metrologia*, **5**, No. 1, pp. 32–33 (January 1969).
- [34] Evenson, K. M., Wells, J. S., and Matarrese, L. M., "Absolute frequency measurements of the  $CO_2$  cw laser at 28 THz ( $10.6 \mu m$ )," *Appl. Phys. Lett.*, **16**, No. 6, pp. 251–253 (March 15, 1970).
- [35] Daneu, V., Sokoloff, D., Sanchez, A., and Javan, A., "Extension of laser harmonic-frequency mixing techniques into the  $9 \mu$  region," *Appl. Phys. Lett.*, **15**, No. 12, pp. 398–401 (December 1969).
- [36] Church, D., and Dehmelt, H. G., "Radiative cooling of an electro-dynamically contained proton gas," *J. Appl. Phys.*, **40**, No. 9, pp. 3421–3424 (August 1969).
- [37] Larson, D. J., Valberg, P. A., and Ramsey, N. F., "Measurements of the hydrogen-deuterium atomic magnetic moment ratio and of the deuterium hyperfine frequency," *Phys. Rev. Lett.*, **23**, No. 24, pp. 1369–1372 (December 15, 1969).
- [38] Crampton, S. B., Kleppner, D., and Ramsey, N. F., "Hyperfine separation of ground state atomic hydrogen," *Phys. Rev. Lett.*, **11**, No. 7, pp. 338–340 (October 1, 1963).
- [39] Hellwig, H., Vessot, R. F. C., Levine, M. W., Zitzewitz, P. W., Allan, D. W., and Glaze, D. J., "Measurement of the unperturbed hydrogen hyperfine transition frequency," *IEEE Trans. on Instrum. and Meas.*, **IM-19**, No. 4, pp. 200–209 (November 1970).
- [40] Mathur, B. S., Crampton, S. B., Kleppner, D., and Ramsey, N. F., "Hyperfine separation of tritium," *Phys. Rev.*, **158**, No. 1, pp. 14–17 (June 5, 1967).
- [41] Fortson, E. N., Major, F. G., and Dehmelt, H. G., "Ultra-high resolution of  $\Delta F = 0, \pm 1$  ( $He^3$ )<sup>+</sup> HFS spectra by an ion-storage collision technique," *Phys. Rev. Lett.*, **16**, No. 6, pp. 221–225 (February 7, 1966).
- [42] Bonanomi, J., "A thallium beam frequency standard," *IRE Trans. on Instrum.*, **1-11**, Nos. 3 and 4, pp. 212–215 (December 1962).
- [43] Beehler, R. E., and Glaze, D. J., "Evaluation of a thallium atomic beam frequency standard at the National Bureau of Standards," *IEEE Trans. on Instrum. and Meas.*, **IM-15**, Nos. 1 and 2, pp. 55–58 (March and June 1966).
- [44] DePrins, J., Menoud, C., and Kartaschoff, P., " $N^{15}H_3$  double-beam maser as a primary frequency standard," *Rev. Sci. Instrum. (Lett.)*, **32**, No. 11, pp. 1267–1268 (November 1961).
- [45] Cupp, R. E., Kempf, R. A., and Gallagher, J. J., "Hyperfine structure in the millimeter spectrum of hydrogen sulfide: Electric resonance spectroscopy on asymmetric-top molecules," *Phys. Rev.*, **171**, No. 1, pp. 60–69 (July 5, 1968).
- [46] Hocker, L. O., and Javan, A., "Absolute frequency measurements on new cw HCN submillimeter laser lines," *Phys. Lett.*, **25A**, No. 7, 489–491 (October 9, 1967).
- [47] Evenson, K. M., Wells, J. S., Matarrese, L. M., and Elwell, L. B., "Absolute frequency measurements of the 28- and 78- $\mu m$  cw water vapor laser lines," *Appl. Phys. Lett.*, **16**, No. 4, pp. 159–161 (February 1970).
- [48] Frenkel, L., Sullivan, T., Pollack, M. A., and Bridges, T. J., "Absolute frequency measurement of the 118.6  $\mu m$  water-vapor laser transition," *Appl. Phys. Lett.*, **11**, No. 11, pp. 344–345 (December 1, 1967).
- [49] Hocker, L. O., Small, J. G., and Javan, A., "Extension of absolute frequency measurements to the 84  $\mu$  range," *Phys. Lett.*, **29A**, No. 6, pp. 321–323 (June 2, 1969).
- [50] Sokoloff, D., and Javan, A., "Absolute frequency determination of 9.3  $\mu CO_2$  laser transitions," *Bull. Am. Phys. Soc—Series II*, **15**, No. 4, p. 505 (April 1970).
- [51] Josephson, B. D., "Supercurrents through barriers," *Adv. Phys.*, **14**, No. 55, pp. 419–451 (October 1965).
- [52] Parker, W. H., Langenberg, D. N., Denenstein, A., and Taylor, B. N., "Determination of  $e/h$  using macroscopic quantum phase coherence in superconductors. I. Experiment," *Phys. Rev.* **177**, No. 2, pp. 639–664 (January 10, 1969).
- [53] Petley, B. W., and Morris, K., "A measurement of  $2e/h$  by the a-c Josephson effect," *Metrologia*, **6**, No. 2, pp. 46–51 (April 1970).
- [54] Taylor, B. N., Parker, W. H., and Langenberg, D. N., "Determination of  $e/h$  using macroscopic quantum phase coherence in superconductors; implications for quantum electrodynamics and the fundamental physical constants," *Rev. Mod. Phys.*, **41**, No. 3, pp. 375–496 (July 1969).
- [55] Dirac, P. A. M., "A new basis for cosmology," *Proc. Royal Soc. London*, **A165**, No. A921, pp. 199–208 (April 5, 1938).
- [56] Simkin, G. S., "Establishment of a single time and length standard," translated from *Izmeritel Naya Tekhnika*, No. 10, pp. 6–10 (October 1968); *Meas. Tech. (USSR)*, No. 10, pp. 1308–1314 (Consultants Bureau, New York, NY 10011, October 1968).
- [57] Townes, C. H., "Production of coherent radiation by atoms and molecules," *Science*, **149**, No. 3686, pp. 831–841 (August 20, 1965).
- [58] Essen, L., "The units of time and length," *Nature (Lett.)*, **180**, No. 4577, pp. 137–138 (July 20, 1957).
- [59] NBS, "Mole adopted as International System Base Unit," *Nat. Bur. Stand. (U.S.) Tech. News Bull.*, **56**, No. 2, pp. 42–43 (USGPO, February 1972).
- [60] Evenson, K. M., Day, G. W., Wells, J. S., and Mullen, L. O., "Extension of absolute frequency measurements to the cw He-Ne laser at 88 THz ( $3.39 \mu$ )," *Appl. Phys. Lett.*, **20**, No. 3, pp. 133–134 (February 1, 1972).
- [61] Evenson, K. M., Wells, J. S., Petersen, F. R., Danielson, B. L., Day, G. W., Barger, R. L., and Hall, J. L., "Speed of light from direct frequency and wavelength measurements of the methane-stabilized laser," *Phys. Rev. Lett.*, **29**, No. 19, pp. 1346–1349 (November 6, 1972).
- [62] Wells, J. S., Evenson, K. M., Day, G. W., and Halford, D., "Role of infrared frequency synthesis in metrology," *Proc. IEEE (Lett.)*, **60**, No. 5, pp. 621–623 (May 1972).
- [63] Hellwig, H., "The ion storage technique for application in frequency standards," *Nat. Bur. Stand. (U.S.) Tech. Note* **388**, 23 pp. (USGPO, November 1970).
- [64] Schüssler, H. A., "The ion storage tube, a proposal for a new atomic frequency standard," *Metrologia*, **7**, No. 3, pp. 103–107 (July 1971).
- [65] NBS, "NBS to maintain legal volt using  $2e/h$  via the a-c Josephson effect," *Nat. Bur. Stand. (U.S.) Tech. News Bull.*, **56**, No. 7, pp. 159–160 (USGPO, July 1972).
- [66] Kamper, R. A., and Zimmerman, J. E., "Noise thermometry with the Josephson effect," *J. Appl. Phys.*, **42**, No. 1, pp. 132–136 (January 1971).
- [67] Kamper, R. A., Siegwarth, J. D., Radebaugh, R., and Zimmerman, J. E., "Observation of noise temperature in

- the millikelvin range," *Proc. IEEE*, **59**, No. 9, pp. 1368-1369 (September 1971).
- [68] Halford, D., Hellwig, H., and Wells, J. S., "Progress and feasibility for a unified standard for frequency, time, and length," *Proc. IEEE (Lett.)*, **60**, No. 5, pp. 623-625 (May 1972).
- [69] Page, C. H., and Vigoureux, P. (Editors), "The International System of Units," (American translation of "Le Système International d'Unités," 1970 OFFILB, 48 rue Gay-Lussac, F. 75, Paris 5 (Revised Edition 1972).), *Nat. Bur. Stand. (U.S.) Spec. Publ. 330*, 45 pp. (USGPO, April 1972).
- [70] Glaze, D. J., Hellwig, H., Jarvis, S., Jr., Wainwright, A., and Allan, D. W., "Recent progress on the NBS primary frequency standard," *Proc. 27th Ann. Symp. on Frequency Control* (U.S. Army Electronics Command, Ft. Monmouth, NJ 07703, June 12-14, 1973), pp. 347-356 (Electron. Ind. Assn., Washington, DC 20006, 1973) (see chap. 5B).
- [71] Mungall, A. G., Bailey, R., Daams, H., Morris, D., and Gastain, C. C., "The new NRC 2.1 metre primary beam frequency standard, Cs V," *Metrologia*, **9**, No. 3, pp. 113-127 (September 28, 1973).

## 7.7 SELECTED BIBLIOGRAPHY: FUTURE TRENDS IN ACCURATE FREQUENCY/TIME METROLOGY

- [B1] Astin, A. V., "Standards of measurement," *Scientific Amer.*, **218**, No. 6, pp. 50-62 (June 1968).
- [B2] Barger, R. L., and Hall, J. L., "Pressure shift and broadening of methane line at  $3.39\mu$  studied by laser-saturated molecular absorption," *Phys. Rev. Lett.*, **22**, No. 1, pp. 4-8 (January 6, 1969).
- [B3] Barger, R. L., and Hall, J. L., "Precision wavelength measurement of the methane  $3.39\mu$  saturated absorption line by laser-controlled interferometry," (Abstract), *Precision Measurement and Fundamental Constants*, Proc. Int. Conf. (NBS, Gaithersburg, MD 20760, August 3-7, 1970), D. N. Langenberg and B. N. Taylor, Eds., *Nat. Bur. Stand. (U.S.) Spec. Publ. 343*, p. 51 (USGPO, August 1971).
- [B4] Bay, Z., and Luther, G. G., "Locking a laser frequency to the time standard," *Appl. Phys. Lett.*, **13**, No. 9, pp. 303-304 (November 1, 1968).
- [B5] Bay, Z., "The use of microwave modulation of lasers for length measurements," *Precision Measurement and Fundamental Constants*, Proc. Int. Conf. (NBS, Gaithersburg, MD 20760, August 3-7, 1970), D. N. Langenberg and B. N. Taylor, Eds., *Nat. Bur. Stand. (U.S.) Spec. Publ. 343*, pp. 59-62 (USGPO, August 1971).
- [B6] Bay, Z., "The constancy of the velocity of light and prospects for a unified standardization of time, frequency, and length," *Atomic Masses and Fundamental Constants*, Proc. 4th Int. Conf. on Atomic Masses and Fundamental Constants (Teddington, England, September 1971), J. H. Sanders and A. H. Wapstra, Eds., pp. 323-336 (Plenum Press, London, England, 1972).
- [B7] Bay, Z., and White, J. A., "Frequency dependence of the speed of light in space," *Phys. Rev.*, **D5**, No. 4, pp. 796-798 (February 15, 1972).
- [B8] Bay, Z., Luther, G. G., and White, J. A., "Measurement of an optical frequency and the speed of light," *Phys. Rev. Lett.*, **29**, No. 3, pp. 189-192 (July 17, 1972).
- [B9] Bender, P. L., "Precise measurements of distance and the velocity of light using lasers," (URSI National Committee Report, XIV Gen. Assem., Tokyo, Japan, September 1963; Comm. 1), *Radio Measurement Methods and Standards, Part 7, Radio Sci. J. Res., NBS/USNC-URSI*, **68D**, No. 5, pp. 540-541 (May 1964).
- [B10] Church, D., and Dehmelt, H. G., "Radiative cooling of an electrostatically contained proton gas," *J. Appl. Phys.*, **40**, No. 9, pp. 3421-3424 (August 1969).
- [B11] Cook, A. H., "Quantum metrology-standards of measurement based on atomic and quantum phenomena," *Reports on Progress in Physics*, **35**, No. 5, pp. 463-528 (1972).
- [B12] Daneu, V., Sokoloff, D., Sanchez, A., and Javan, A., "Extension of laser harmonic-frequency mixing techniques into the  $9\mu$  region," *Appl. Phys. Lett.*, **15**, No. 12, pp. 398-401 (December 1969).
- [B13] Dirac, P. A. M., "A new basis for cosmology," *Proc. Royal Soc. London*, **A165**, No. A921, pp. 199-208 (April 5, 1938).
- [B14] Essen, L., and Parry, J. V. L., "An atomic standard of frequency and time interval," *Nature*, **176**, No. 4475, pp. 280-282 (August 13, 1955).
- [B15] Essen, L., "The units of time and length," *Nature (Lett.)*, **180**, No. 4577, pp. 137-138 (July 20, 1957).
- [B16] Essen, L., "Electrical standards in terms of frequency and physical constants," *Alta Frequenza*, **40**, No. 8, pp. 329E-332E (August 1971).
- [B17] Evenson, K. M., Wells, J. S., and Matarrese, L. M., "Absolute frequency measurements of the  $\text{CO}_2$  cw laser at 28 THz ( $10.6\mu\text{m}$ )," *Appl. Phys. Lett.*, **16**, No. 6, pp. 251-253 (March 15, 1970).
- [B18] Evenson, K. M., Wells, J. S., and Matarrese, L. M., "Defining the speed of light: A combination time, frequency, and length standard," *Precision Measurement and Fundamental Constants*, Proc. Int. Conf. (NBS, Gaithersburg, MD 20760, August 3-7, 1970), D. N. Langenberg and B. N. Taylor, Eds., *Nat. Bur. Stand. (U.S.) Spec. Publ. 343*, pp. 67-69 (USGPO, August 1971).
- [B19] Evenson, K. M., Day, G. W., Wells, J. S., and Mullen, L. O., "Extension of absolute frequency measurements to the cw He-Ne laser at 88 THz ( $3.39\mu$ )," *Appl. Phys. Lett.*, **20**, No. 3, pp. 133-134 (February 1, 1972).
- [B20] Evenson, K. M., Wells, J. S., Peterson, F. R., Danielson, B. L., Day, G. W., Barger, R. L., and Hall, J. L., "Speed of light from direct frequency and wavelength measurements of the methane-stabilized laser," *Phys. Rev. Lett.*, **29**, No. 19, pp. 1346-1349 (November 6, 1972).
- [B21] Finnegan, T. F., Denenstein, A., and Langenberg, D. N., "AC Josephson-effect determination of  $e/h$ : A standard of electrochemical potential based on macroscopic quantum phase coherence in superconductors," *Phys. Rev.*, **B4**, No. 5, pp. 1487-1522 (September 1971).
- [B22] Fowler, H. A., Witt, T. J., Toots, J., Olsen, P. T., and Eicke, W., "Referencing of the U.S. national volt against a Josephson frequency-to-voltage source," *Precision Measurement and Fundamental Constants*, Proc. Int. Conf. (NBS, Gaithersburg, MD 20760, August 3-7, 1970), D. N. Langenberg and B. N. Taylor, Eds., *Nat. Bur. Stand. (U.S.) Spec. Publ. 343*, pp. 223-225 (USGPO, August 1971).
- [B23] Gould, G., "Laser frequency standards," *Frequency*, **1**, No. 6, pp. 14-16 (September 1963).
- [B24] Halford, D., Hellwig, H., and Wells, J. S., "Progress and feasibility for a unified standard for frequency, time, and length," *Proc. IEEE (Lett.)*, **60**, No. 5, pp. 623-625 (May 1972).
- [B25] Hall, J. L., and Morey, W. W., "Optical heterodyne measurement of neon laser's millimeter wave difference frequency," *Appl. Phys. Lett.*, **10**, No. 5, pp. 152-155 (March 1, 1967).
- [B26] Hall, J. L., "The laser absolute wavelength standard problem," *IEEE J. Quantum Elect.*, **QE-4**, No. 10, pp. 638-641 (October 1968).
- [B27] Hall, J. L., Barger, R. L., Bender, P. L., Boyne, H. S., Fallor, J. E., and Ward, J., "Precision long path interferometry and the velocity of light," *Electron Technology, Proc. URSI (Comm. 1) Conf. on Laser Meas.*, (Warsaw, Poland, September 24-28, 1968), A. Smolinski and S. Hahn, Eds., **2**, No. 2/3, pp. 53-66 (Institute of Electron Technol., Polish Academy of Sciences, Warsaw, Poland, 1969).
- [B28] Hanes, G. R., and Baird, K. M., "I<sub>2</sub> controlled He-Ne laser at 633 nm: preliminary wavelength," *Metrologia*, **5**, No. 1, pp. 32-33 (January 1969).
- [B29] Hellwig, H., "The hydrogen storage beam tube—a pro-

- posal for a new frequency standard," *Metrologia*, **6**, No. 2, pp. 56-60 (April 1970).
- [B30] Hellwig, H., "Areas of promise for the development of future primary frequency standards," *Metrologia*, **6**, No. 4, pp. 118-126 (October 1970) (see chap. 6).
- [B31] Hellwig, H., and Halford, D., "Accurate frequency measurements: Survey, significance, and forecast," *Precision Measurement and Fundamental Constants*, Proc. Int. Conf. (NBS, Gaithersburg, MD 20760, August 3-7, 1970), D. N. Langenberg and B. N. Taylor, Eds., *Nat. Bur. Stand. (U.S.) Spec. Publ. 343*, pp. 17-25 (USGPO, August 1971).
- [B32] Hocker, L. O., Small, J. G., and Javan, A., "Extension of absolute frequency measurements to the 84  $\mu$  range," *Phys. Lett.*, **29A**, No. 6, pp. 321-323 (June 2, 1969).
- [B33] Josephson, B. D., "Supercurrents through barriers," *Adv. Phys.*, **14**, No. 56, pp. 419-451 (October 1965).
- [B34] Kamper, R. A., and Zimmerman, J. E., "Noise thermometry with the Josephson effect," *J. Appl. Phys.*, **42**, No. 1, pp. 132-136 (January 1971).
- [B35] Kovalevsky, J., "Astronomical time," *Metrologia*, **1**, No. 4, pp. 169-179 (October 1965).
- [B36] Langenberg, D. N., and Taylor, B. N., (Eds.), *Precision Measurement and Fundamental Constants*, Proc. Int. Conf. (NBS, Gaithersburg, MD 20760, August 3-7, 1970), *Nat. Bur. Stand. (U.S.) Spec. Publ.*, **343**, 543 pp. (USGPO, August 1971).
- [B37] Markowitz, W., Hall, R. G., Essen, L., and Parry, J. V. L., "Frequency of caesium in terms of ephemeris time," *Phys. Rev. Lett.*, **1**, No. 3, pp. 105-106 (August 1, 1958).
- [B38] McDonald, D. G., Risley, A. S., Cupp, J. D., and Evenson, K. M., "Harmonic mixing of microwave and far-infrared laser radiation using a Josephson junction," *Appl. Phys. Lett.*, **18**, No. 4, pp. 162-164 (February 15, 1971).
- [B39] McNish, A. G., "The basis of our measuring system," *Proc. IRE*, **47**, No. 5, pp. 636-643 (May 1959).
- [B40] NBS, "Mole adopted as International System Base Unit," *Nat. Bur. Stand. (U.S.) Tech. News Bull.*, **56**, No. 2, pp. 42-43 (USGPO, February 1972).
- [B41] NBS, "NBS to maintain legal volt using  $2e/h$  via the ac Josephson effect," *Nat. Bur. Stand. (U.S.) Tech. News Bull.*, **56**, No. 7, pp. 159-160 (USGPO, July 1972).
- [B42] Page, C. H., and Vigoureux, P. (Eds.), "The International System of Units," (American translation of "Le Système International d'Unités," 1970 OFFILB, 48 rue Gay-Lussac, F. 75, Paris 5 (Revised Edition 1972).), *Nat. Bur. Stand. (U.S.) Spec. Publ. 330*, 45 pp. (USGPO, April 1972).
- [B43] Parker, W. H., Langenberg, D. N., Denenstein, A., and Taylor, B. N., "Determination of  $e/h$  using macroscopic quantum phase coherence in superconductors. I. Experiment," *Phys. Rev.*, **177**, No. 2, pp. 639-664 (January 10, 1969).
- [B44] Petley, B. W., and Morris, K., "A measurement of  $2e/h$  by the a-c Josephson effect," *Metrologia*, **6**, No. 2, pp. 46-51 (April 1970).
- [B45] Sanders, J. H., and Wapstra, A. H., (Eds.), *Atomic Masses and Fundamental Constants*, Proc. 4th Int. Conf. on Atomic Masses and Fundamental Constants (Teddington, England, September 1971), Part 6, "Velocity of light," pp. 295-336 (Plenum Press, London, England, 1972).
- [B46] Simkin, G. S., "Establishment of a single time and length standard," translated from *Izmeritel'naya Tekhnika*, No. 10, pp. 6-10 (October 1968); *Meas. Tech. (USSR)*, No. 10, pp. 1308-1314 (Consultants Bureau, New York, NY 10011, October 1968).
- [B47] Sokoloff, D., and Javan, A., "Absolute frequency determination of  $9.3 \mu$  CO<sub>2</sub> laser transitions," *Bull. Am. Phys. Soc. - Series II*, **15**, No. 4, p. 505 (April 1970).
- [B48] Taylor, B. N., Parker, W. H., and Langenberg, D. N., "Determination of  $e/h$  using macroscopic quantum phase coherence in superconductors; implications for quantum electrodynamics and the fundamental physical constants," *Rev. Mod. Phys.*, **41**, No. 3, pp. 375-496 (July 1969).
- [B49] Terrien, J., "Scientific metrology on the international plane and the Bureau International des Poids et Mesures," *Metrologia*, **1**, No. 1, pp. 15-26 (January 1965).
- [B50] Terrien, J., "News from the International Bureau of Weights and Measures—the 54th meeting of the Comité International des Poids et Mesures," *Metrologia*, **1**, No. 1, pp. 55-56 (January 1966).
- [B51] Terrien, J., "Fundamental metrology—present state and recent progress in some important fields of fundamental metrology, and functions of consultative committees of the International Committee of Weights and Measures," *Metrologia*, **8**, No. 3, pp. 99-108 (July 1972).
- [B52] Warner, B., and Nather, R. E., "Wavelength independence of the velocity of light in space," *Nature (Lett.)*, **222**, No. 5189, pp. 157-158 (April 12, 1969).
- [B53] Wells, J. S., Evenson, K. M., Day, G. W., and Halford, D., "Role of infrared frequency synthesis in metrology," *Proc. IEEE (Lett.)*, **60**, No. 5, pp. 621-623 (May 1972).



## CHAPTER 8

### STATISTICS OF TIME AND FREQUENCY DATA ANALYSIS\*●

David W. Allan,† John H. Shoaf,† and Donald Halford†

#### Contents

	Page
8.1. Introduction.....	153
8.2. Definitions and Fundamentals.....	153
8.2.1. Aspects of Time.....	153
8.2.2. Definitions: Stability, Reproducibility, Accuracy.....	153
8.3. Characterization of Frequency Stability.....	154
8.4. Requirements for a Measure of Frequency Stability.....	155
8.5. Concepts of Frequency Stability.....	156
8.6. The Definition of Measures of Frequency Stability (Second Moment Type).....	156
8.6.1. First Definition of the Measure of Frequency Stability—Frequency Domain..	157
8.6.2. Second Definition of the Measure of Frequency Stability—Time Domain.....	157
8.6.3. Distributions.....	158
8.6.4. Treatment of Systematic Variations.....	158
8.7. Translations among Frequency Stability Measures.....	159
8.7.1. Frequency Domain to Time Domain.....	159
8.7.2. Time Domain to Frequency Domain.....	159
8.7.3. Translations among the Time Domain Measures.....	160
8.8. Examples of Applications of Previously Developed Measures.....	161
8.8.1. Applications of Stability Measures.....	161
a. Doppler Radar.....	161
b. Clock Errors.....	161
8.9. Measurement Techniques for Frequency Stability.....	162
8.9.1. Heterodyne Techniques (General).....	162
8.9.2. Period Measurement.....	163
8.9.3. Period Measurement with Heterodyning.....	163
8.9.4. Frequency Counters.....	163
8.9.5. Frequency Discriminators.....	164
8.9.6. Common Hazards.....	164
8.10. Summary of Frequency Stability Measures.....	165
8.11. Practical Applications of Frequency Stability Specification and Measurement.....	165
8.12. Terminology for Specification of Frequency Stability.....	165
8.13. Comparison of Measurement Techniques.....	167
8.14. Operational Systems for Measurement of Frequency Stability at NBS (High Frequency Region).....	168
8.14.1. Frequency Domain Measurements.....	168
8.14.2. Time Domain Measurements.....	170
8.14.3. Differential Phase Noise Measurements.....	171

\*Manuscript received May 18, 1973.

●Parts of this Chapter have been modified from "Characterization of frequency stability" published in *IEEE Trans. on Instrum. and Meas.*, May 1971 (see reference [1]), publication herein is at concurrence of the IEEE.

†Time and Frequency Division, Institute for Basic Standards, National Bureau of Standards, Boulder, Colorado 80302.

8.15. Operational Systems for Measurement of Frequency Stability at NBS (Microwave Region).....	171
8.15.1. Basic Considerations of the Microwave (Frequency Stability) Measurement System .....	173
8.15.2. Description of the Microwave (Frequency Stability) Measurement System...	173
8.15.3. Calibration Procedure .....	173
8.15.4. Measurement Procedure .....	173
8.15.5. Additional Techniques for Frequency Stability Measurements at X-Band...	174
8.16. Conclusions/Summary .....	175
8.17. References.....	175
Annex 8.A Glossary of Symbols.....	176
Annex 8.B Translation of Data from Frequency Domain to Time Domain Using the Conversion Chart (table 8.1).....	178
Annex 8.C Spectral Densities: Frequency Domain Measures of Stability.....	178
Annex 8.D A Sample Calculation of Script $\mathcal{L}$ .....	180
Annex 8.E A Sample Calculation of Allan Variance, $\sigma_y^2(\tau)$ .....	181
Annex 8.F Computing Counter Program Using an Efficient Overlapping Estimator for $\langle \sigma_y^2(N = 2, T, \tau, f_h) \rangle^{1/2}$ .....	182
Annex 8.G Selected Frequency Stability References: Bibliography.....	182
Annex 8.H Detailed Procedure for Calibrating Microwave (Frequency Stability) Measurement System .....	187
Annex 8.I Measurement Procedure for Determining Frequency Stability in the Microwave Region.....	188
Annex 8.J Tables of Bias Functions, $B_1$ and $B_2$ , for Variances Based on Finite Samples of Processes With Power Law Spectral Densities.....	190
Table 8.1. Stability Measure Conversion Chart.....	166

"As a concept for ordering and analyzing real events with variable amounts of information 'time' is much more complex than a simple clock-measure."

Patrick Meredith,  
*Study of Time*, p. 84

The fluctuations about the average of a time or frequency signal characterize its quality. The statistical characteristics of the random fluctuations are needed in any clear statement regarding the stability of the signal as well as the credibility of the average value. We describe two methods of characterizing the random fluctuations of a signal, one in the frequency domain and one in the time domain.

In the frequency domain we characterize the fluctuations using the spectral density of the fluctuations of the time or of the fractional frequency. We use spectral densities which are one-sided and are on a per hertz basis. In the time domain the Allan variance is employed to characterize the time fluctuations and/or the fractional frequency fluctuations. The need to specify certain aspects of the measurement is emphasized, i.e., the sample time, the sample repetition rate, the measurement system bandwidth, and the number of samples in each variance. The relationships between these measures of stability are given.

Power law spectral densities can describe the commonly occurring kinds of random fluctuations which include white noise and flicker noise time or frequency fluctuations. For these commonly occurring noise processes some tables of convenient relationships between the frequency domain and the time domain measures are also given. In addition, for different, but specific, power law noise processes the dependence of the time domain stability measure on the number of samples or on the dead time of the measurement process is tabulated. The above stability measures have proven very useful, and examples of application are given, e.g., estimation of the time dispersion of a clock and specification of the detailed quality of a state-of-the-art frequency standard. Operational systems for measurement of frequency stability are described in detail sufficient for duplicating techniques and results.

Key words: Allan variance; frequency; frequency domain; frequency stability measurements; measurement system description; phase noise; sample variance; spectral density; stability definitions; terminology standards; time domain clock statistics; time/frequency statistics; variance.

## 8.1. INTRODUCTION

This chapter discusses some reasonable measures for time and/or frequency deviations. The subject is treated on both the theoretical and practical level. Section 8.2 presents some definitions and fundamentals to give understanding into what a deviation is. Sections 8.3 through 8.10 give a theoretical exposition into measures of frequency stability and contain major parts of the paper, "Characterization of frequency stability," by J. A. Barnes et al. [1].<sup>1</sup> Sections 8.11 through 8.15 show general applications and examples of stability measures in the laboratory, based on the paper cited above [1] and from the NBS Technical Note entitled "Frequency stability specification and measurement: High frequency and microwave signals" [2]. Standards of terminology and measurement techniques are recommended to facilitate conformity in reporting results from various laboratories with a commonality of reference. Some ten annexes are given. They include a glossary of terms, sample calculations and derivations, a frequency stability computer program, selected references and a bibliography applicable to frequency stability, and a reproduction of bias function tables. This latter is part of the NBS Technical Note, "Tables of bias functions,  $B_1$  and  $B_2$ , for variances based on finite samples of processes with power law spectral densities" [3]. We have attempted to coordinate the chapter with sufficient independence of subject matter but allowing adequate material in a given area to satisfy both the theorist and the practical engineer.

## 8.2. DEFINITIONS AND FUNDAMENTALS

### 8.2.1. Aspects of Time

Time—as one of the four independent base units of measurement—has been adopted as a defined quantity. Currently, the unit of time is defined: "The second is the duration of 9 192 631 770 periods of the radiation corresponding to the transition between the two hyperfine levels of the ground state of the cesium-133 atom," as decreed by the General Conference on Weights and Measures [4] (see chap. 1, ann. 1.A.1). There are three fundamental aspects of time<sup>2</sup>: the first, covered by the definition above, is time interval which can be related to frequency—frequency being the inverse period of an oscillation. The second aspect is that of date or clock reading which often has been called epoch. We prefer the use of the word date because epoch has alternate meanings that could lead to confusion. Date or

clock reading is simply the counting or accumulation—starting from some predetermined origin—of unit time intervals; e.g., "A special adjustment to the standard-frequency and time-signal emissions should be made at the end of 1971 so that the reading of the UTC scale will be 1 January 1972, 0h 0m 0s at the instant when the reading of Atomic Time (AT) indicated by the Bureau International de l'Heure (BIH) will be 1 January 1972, 0h 0m 10s" [5] (see chap. 1, ann. 1.B). The third aspect is simultaneity—the practical application of which is clock synchronization; i.e., two clocks have the same reading in some frame of reference.

### 8.2.2. Definitions: Stability, Reproducibility, Accuracy

Let us define a *clock* as a frequency standard coupled with a counter-divider. We next might question why a clock deviates from the ideal, where an ideal clock realizes the ultimate of the above three aspects of time. To further explain, the ideal clock's unit time interval would agree exactly with the definition, and at some particular moment the reading of the clock would agree exactly (would be synchronous) with some defined date or origin. Categorically there are two reasons for deviations. First, the clock may have *deterministic* biases; e.g., the frequency may drift with time, the calibration of the unit time interval or the frequency may have had an error—causing a systematic accumulation of time error, or the clock's initial reading (date) may have been set erroneously. This first category may be called nonrandom. Second, the clock will have *random* deviations caused by various kinds of random noise processes inherent in all clocks; e.g., the shot noise at the detector in an atomic beam frequency standard causes a random walk in the time deviations when this standard is integrated in a clock. Often, and meaningfully so, a random deviation in time or frequency is called a time fluctuation or a frequency fluctuation, respectively.

We will now define some terms to better describe nonrandom and random deviations in a time and/or frequency standard. In this regard we have drawn on the work of others [6] as well as collaborated with co-workers [7]; in addition a strong attempt was made to make the definitions consistent with current methods of characterizing frequency and time stability.

We consider *accuracy* as the degree of conformity of a measured and/or calculated value to some specified figure or definition. For example, the time accuracy is the degree of conformity of a clock's date with some defined date; and the time interval accuracy—which corresponds to the clock rate or frequency accuracy—is the conformity with the definition for the second as given in Section 8.2.1. Typically, the prime cause of inaccuracy results from nonrandom deviations, but naturally it involves random fluctuations as well.

<sup>1</sup> Figures in brackets indicate literature references at the end of this chapter.

<sup>2</sup> See Chapter 1 on "Basic Concepts of Precise Time and Frequency."

To determine the accuracy of a device or standard, it is necessary to evaluate every parameter which may cause a deviation from the definition. It is necessary to consider both (a) an estimate of the uncertainty in determining the magnitude of the deviation (intrinsic reproducibility of that parameter), and (b) the precision (see definition below of any measurement involved in the evaluation). If the parameters are independent in their effect in causing deviations from the definitions, then the uncertainties and precisions may be added as the square root of the sum of the squares to give an accuracy specification. It clearly should be stated also whether the accuracy has a one-, two-, or three-sigma ( $\sigma$ =standard deviation) confidence limit; naturally, the uncertainties and precisions should be consistent with the estimate of the accuracy specification.

By *stability* we mean the frequency domain and/or time domain behavior of a process. The proposed frequency domain measure of frequency stability is the spectral density of the fractional frequency fluctuations,  $S_y(f)$ . The proposed measure of stability in the time domain is the Allan variance (or its square root) [1, 8]. One commonly measures the instabilities caused by the random fluctuations in a device; obviously, though, the nonrandom deviations can contribute instabilities. Section 8.6 develops and defines stability measures for frequency and time.

*Precision* is the performance capability of a measurement process with contributions from both the measurement equipment and the devices or standards being measured. Precision is often the best consistently attainable indicator for the measurement process. Consider, too, the precision of a frequency standard measurement is limited by the instability of either the standard or the measurement equipment, whichever is worse. On the other hand, a time interval measuring instrument may have a precision of 0.1 ns inherent within the processing electronic counting and measuring devices; in contrast, it may have an accuracy of 1 ns, where the accuracy now requires also a knowledge of the actual delays involved in the instrument. The precision of a measurement for a standard with random uncorrelated fluctuations (usually idealized but an unrealistic assumption) in output is simply the standard deviation of the mean of these fluctuations; typically, a data set taken as a time series has some correlation. If such is the case, then a measure of the precision of a measurement could be the time domain stability ( $\sigma_y(\tau)$ ) (defined in sec. 8.6.2)) at a sampling or averaging time,  $\tau$ , such that the stability no longer improves with increasing  $\tau$ . In such a specification the  $\tau$  value or values need to be stated along with the number of samples, the measurement system bandwidth, and the dead time between data samples. The accuracy can never be better than the precision.

*Reproducibility* means the degree of agreement

across a set of independent (in space and/or time) devices of the same design after exclusive evaluation of appropriate parameters in each device. An independent set of devices may consist of either an ensemble of devices or standards constructed according to the same procedure, or a single device having all parameters independently adjusted through reevaluation. For the single device, the degree of agreement is often called intrinsic reproducibility. Reproducibility is a relative measure in contrast to accuracy which is an absolute measure. The word accuracy is sometimes erroneously used in place of reproducibility, and it is clear that a device's accuracy can never be better than its reproducibility. One acceptable measure of reproducibility would be the following: given a mean value for each of a set of measurements across an ensemble or on a device as stated above, the reproducibility is the standard deviation of this set of measurements about the mean.

### 8.3. CHARACTERIZATION OF FREQUENCY STABILITY

The measurement of frequency and fluctuations in frequency has received such great attention for so many years that it is surprising that the concept of frequency stability does not have a universally accepted definition. At least part of the reason has been that some uses are most readily described in frequency domain and other uses in the time domain, as well as in combinations of the two. This situation is further complicated by the fact that only recently have noise models been presented which both adequately describe performance and allow a translation between the time and frequency domains. Indeed, only recently has it been recognized that there can be a wide discrepancy between commonly-used time domain measures themselves. Following the NASA-IEEE Symposium on Short-Term Stability in 1964 [9] and the Special Issue on Frequency Stability of the *Proc. IEEE* of February 1966 [10], it now seems reasonable to propose a definition of frequency stability. The paper by Barnes et al. [1] was presented as technical background for an eventual IEEE standard definition.

This section attempts to present (as concisely as practical) adequate, self-consistent definitions of frequency stability. Since more than one definition of frequency stability is presented, an important part of this section (perhaps the most important part) deals with translations among the suggested definitions of frequency stability. The applicability of these definitions to the more common noise models is demonstrated. Consistent with an attempt to be concise, the cited references have been selected for greatest value to the reader rather than for their exhaustive nature. Annex 8.G is a more comprehensive reference and bibliographic listing covering the subject of frequency stability.

Almost any signal generator is influenced to some extent by its environment. Thus, observed frequency instabilities may be traced, for example, to changes in ambient temperature, supply voltages, magnetic field, barometric pressure, humidity, physical vibration, or even output loading to mention the more obvious. While these environmental influences may be extremely important for many applications, the definition of frequency stability presented here is independent of these casual factors. In effect, we cannot hope to present an exhaustive list of environmental factors and a prescription for handling each, even though these environmental factors may be by far the most important in some cases. Given a particular signal generator in a particular environment, one can obtain its frequency stability with the measures presented herein, but one should not then expect the frequency stability always to be the same in a new environment.

It is natural to expect any definition of stability to involve various statistical considerations such as stationarity, ergodicity, average, variance, spectral density, etc. There often exist fundamental difficulties in rigorous attempts to bring these concepts into the laboratory. It is worth considering, specifically, the concept of stationarity since it is at the root of many statistical discussions.

A random process is mathematically defined as stationary if every translation of the time coordinate maps the ensemble onto itself. As a necessary condition, if one looks at the ensemble at one instant of time,  $t$ , the distribution in values within the ensemble is exactly the same as at any other instant of time,  $t'$ . This is not to imply that the elements of the ensemble are constant in time, but, as one element changes value with time, other elements of the ensemble assume the previous values. Looking at it in another way, by observing the ensemble at some instant of time, one can deduce no information as to when the particular instant was chosen. This same sort of invariance of the joint distribution holds for any set of time  $t_1, t_2, \dots, t_n$  and its translation  $t_1 + \tau, t_2 + \tau, \dots, t_n + \tau$ .

It is apparent that any ensemble that has both a finite past and future cannot be stationary, and this neatly excludes the real world and anything of practical interest. The concept of stationarity does violence to concepts of causality since we implicitly feel that current performance (i.e., the applicability of stationary statistics) cannot be logically dependent upon future events (i.e., if the process is terminated sometime in the distant future). Also, the verification of stationarity would involve hypothetical measurements which are not experimentally feasible, and therefore the concept of stationarity is not directly relevant to experimentation.

Actually the utility of statistics is in the formation of idealized models which *reasonably* describe significant observables of real systems. One may,

for example, consider a hypothetical ensemble of noises with certain properties (such as stationarity) as a model for a particular real device. If a model is to be acceptable, it should have at least two properties: First the model should be tractable; that is, one should be able to easily arrive at estimates for the elements of the model; and, second, the model should be consistent with *observables* derived from the real device which it is simulating.

Notice that one does not need to know that the device was selected from a stationary ensemble, but only that the observables derived from the device are consistent with, say, elements of a hypothetically stationary ensemble. Notice also that the actual model used may depend upon how clever the experimenter-theorist is in generating models. It is worth noting, however, that while some texts on statistics give "tests for stationarity," these "tests" are almost always inadequate. Typically, these "tests" determine only if there is a substantial fraction of the noise power in Fourier frequencies whose periods are of the same order as the data length or longer. While this may be very important, it is *not* logically essential to the concept of stationarity. If a non-stationary model actually becomes common, it will almost surely result from usefulness or convenience, and not because the process is "actually non-stationary." Indeed, the phrase "actually non-stationary" appears to have no meaning in an operational sense. In short, stationarity (or non-stationarity) is a property of models and not a property of data [11].

Fortunately, many statistical models exist which adequately describe most present-day signal generators; many of these models are considered below. It is obvious that one cannot guarantee that *all* signal generators are adequately described by these models, but it is felt that they are adequate for the description of most signal generators presently encountered.

#### 8.4. REQUIREMENTS FOR A MEASURE OF FREQUENCY STABILITY

To be useful, a measure of frequency stability must allow one to predict performance of signal generators used in a wide variety of situations as well as allow one to make meaningful relative comparisons among signal generators. One must be able to predict performance in devices which may most easily be described in the time domain, the frequency domain, or in a combination of the two. This prediction of performance may involve actual distribution functions, and thus second moment measures (such as power spectra and variances) are not totally adequate.

Two common types of equipment used to evaluate the performance of a frequency source are (analog) spectrum analyzers (frequency domain) and digital, electronic counters (time domain). On occasion the digital counter data are converted to power spectra

by computers. One must realize that any piece of equipment simultaneously has certain aspects most easily described in the time domain and other aspects most easily described in the frequency domain. For example, an electronic counter has a high frequency limitation, and experimental spectra are determined with finite time averages.

Research has established that ordinary oscillators demonstrate noise which appears to be a superposition of causally generated signals and random, nondeterministic noises. The random noises include thermal noise, shot noise, noises of undetermined origin (such as flicker noise), and integrals of these noises. One might well expect, that for the more general cases, it would be necessary to use a nonstationary model (not stationary even in the wide sense, i.e., the covariance sense). Non-stationarity would, however, introduce significant difficulties in the passage between the frequency and time domains. It is interesting to note that, so far, experimenters have seldom found a non (covariance) stationary model useful in describing actual oscillators. In what follows, an attempt has been made to separate general statements (which hold for any noise or perturbation) from those which apply only to specific models. It is important that these distinctions be kept in mind.

## 8.5. CONCEPTS OF FREQUENCY STABILITY

To discuss the concept of frequency stability immediately implies that frequency can change with time and thus one is not considering Fourier frequencies (at least at this point). The conventional definition of instantaneous (angular) frequency is the time rate of change of phase; that is,

$$2\pi\nu(t) \equiv \frac{d\Phi(t)}{dt} \equiv \dot{\Phi}(t), \quad (8.1)$$

where  $\Phi(t)$  is the instantaneous phase of the oscillator. By our convention, time dependent frequencies of oscillators are denoted by  $\nu(t)$  (cycle frequency, hertz), and Fourier frequencies are denoted by  $\omega$  (angular frequency, radians per second) or  $f$  (cycle frequency, hertz) where

$$\omega \equiv 2\pi f. \quad (8.2)$$

In order for eq (8.1) to have meaning, the phase  $\Phi(t)$  must be a well-defined function. This restriction immediately eliminates some "nonsinusoidal" signals such as a pure, random, uncorrelated ("white") noise. For most real signal generators, the concept of phase is reasonably amenable to an operational definition and this restriction is not serious.

Of great importance to this presentation is the concept of spectral density,  $S_g(f)$ . The notation,  $S_g(f)$ , represents the one-sided spectral density

of the (pure real) function,  $g(t)$ , on a per hertz basis; that is, the total "power" or mean square value of  $g(t)$  is given by

$$\int_0^\infty S_g(f) df. \quad (8.3)$$

Since the spectral density is such an important concept to what follows, it is worthwhile to present some important references on spectrum estimation. Many workers have estimated spectra from data records, but worthy of special note are [12-15].

## 8.6. THE DEFINITION OF MEASURES OF FREQUENCY STABILITY

### (Second Moment Type)

In a general sense, consider a signal generator whose instantaneous output voltage,  $V(t)$ , may be written as

$$V(t) = [V_0 + \epsilon(t)] \sin [2\pi\nu_0 t + \varphi(t)], \quad (8.4)$$

where  $V_0$  and  $\nu_0$  are the nominal amplitude and frequency respectively of the output, and it is assumed that

$$\left| \frac{\epsilon(t)}{V_0} \right| \ll 1, \quad (8.5)$$

and

$$\left| \frac{\dot{\varphi}(t)}{2\pi\nu_0} \right| \ll 1. \quad (8.6)$$

for substantially all time,  $t$ . Making use of eqs (8.1) and (8.4) one sees that

$$\Phi(t) = 2\pi\nu_0 t + \varphi(t), \quad (8.7)$$

and

$$\nu(t) = \nu_0 + \frac{1}{2\pi} \dot{\varphi}(t). \quad (8.8)$$

Equations (8.5) and (8.6) are essential in order that  $\varphi(t)$  may be defined conveniently and unambiguously (see sec. 8.9).

Since eq (8.6) must be valid even to speak of an instantaneous frequency, there is no real need to distinguish *stability* measures from *instability* measures. That is, any fractional frequency stability measure will be far from unity, and the chance of confusion is slight. It is true that in a very strict sense people usually measure *instability* and speak of *stability*. Because the chances of confusion are so slight, we choose to continue the custom of measuring "instability" and speaking of *stability* (a number always much less than unity).

Of significant interest to many people is the radio frequency (RF) spectral density,  $S_\nu(f)$ . This is of direct concern in spectroscopy and radar. However, this is *not* a good primary measure of frequency

stability for two reasons: First, fluctuations in the amplitude,  $\epsilon(t)$ , contribute directly to  $S_V(f)$ ; and second, for many cases when  $\epsilon(t)$  is insignificant, the RF spectrum,  $S_V(f)$ , is not uniquely related to the frequency fluctuations [16].

### 8.6.1. First Definition of the Measure of Frequency Stability—Frequency Domain

By definition, let

$$y(t) \equiv \frac{\varphi(t)}{2\pi\nu_0}, \quad (8.9)$$

where  $\varphi(t)$  and  $\nu_0$  are as in eq (8.4). Thus  $y(t)$  is the instantaneous fractional frequency deviation from the nominal frequency  $\nu_0$ . A proposed definition of frequency stability is the spectral density  $S_y(f)$  of the instantaneous fractional frequency fluctuations  $y(t)$ . The function  $S_y(f)$  has the dimensions of  $\text{Hz}^{-1}$ .

One can show [17] that if  $S_\varphi(f)$  is the spectral density of the phase fluctuations, then

$$\begin{aligned} S_y(f) &= \left(\frac{1}{2\pi\nu_0}\right)^2 S_\varphi(f), \\ &= \left(\frac{1}{\nu_0}\right)^2 f^2 S_\varphi(f). \end{aligned} \quad (8.10)$$

Thus, a knowledge of the spectral density of the phase fluctuations,  $S_\varphi(f)$ , characterizes the spectral density of the frequency fluctuations,  $S_y(f)$ —the first definition of frequency stability. Of course,  $S_y(f)$  cannot be *perfectly* measured—this is the case for any physical quantity; useful estimates of  $S_y(f)$  are, however, easily obtainable.

### 8.6.2. Second Definition of the Measure of Frequency Stability—Time Domain

The second definition is based on the sample variance of the fractional frequency fluctuations. This measure of frequency stability uses  $\bar{y}_k$ , defined as follows:

$$\bar{y}_k \equiv \frac{1}{\tau} \int_{t_k}^{t_k+\tau} y(t) dt = \frac{\varphi(t_k+\tau) - \varphi(t_k)}{2\pi\nu_0\tau}, \quad (8.11)$$

where  $t_{k+1} = t_k + T$ ;  $k = 0, 1, 2, \dots$ ;  $T$  is the repetition interval for measurements of duration  $\tau$ ; and  $t_0$  is arbitrary. Conventional frequency counters measure the number of cycles in a period  $\tau$ ; that is, they measure  $\nu_0\tau(1 + \bar{y}_k)$ . When  $\tau$  is one second they count the number  $\nu_0(1 + \bar{y}_k)$ . The second measure of frequency stability, then, is defined in analogy to the sample variance by the relation

$$\langle \sigma_y^2(N, T, \tau) \rangle \equiv \left\langle \frac{1}{N-1} \sum_{n=1}^N \left( \bar{y}_n - \frac{1}{N} \sum_{k=1}^N \bar{y}_k \right)^2 \right\rangle, \quad (8.12)$$

where  $\langle g \rangle$  denotes the infinite time average of  $g$ ; that is, the average of the set of all values which  $g$  has over running time,  $t$ . This measure of frequency stability is called the Allan variance of  $y$ . It is dimensionless since  $y$  is dimensionless.

In many situations it would be wrong to assume that eq (8.12) converges to a meaningful limit as  $N \rightarrow \infty$ . First, one cannot practically let  $N$  approach infinity, and, second, it is known that some actual noise processes contain substantial fractions of the total noise power in the Fourier frequency range below one cycle per year. It is important to specify a particular  $N$  and  $T$  to improve comparability of data. For the preferred definition we recommend choosing  $N = 2$  and  $T = \tau$  (i.e., no dead time between measurements). Writing  $\langle \sigma_y^2(N = 2, T = \tau, \tau) \rangle$  as  $\sigma_y^2(\tau)$ , for this particular Allan variance [8], the proposed measure of frequency stability in the time domain may be written as

$$\sigma_y^2(\tau) = \left\langle \frac{(\bar{y}_{k+1} - \bar{y}_k)^2}{2} \right\rangle. \quad (8.13)$$

Of course, the experimental estimate of  $\sigma_y^2(\tau)$  must be obtained from finite samples of data, and one can never obtain perfect confidence in the estimate—the true time average is not realizable in a real situation. One estimates  $\sigma_y^2(\tau)$  from a finite number (say,  $M - 1$ ,  $M$  being the number of samples of  $\bar{y}_k$ ) of values of  $\sigma_y^2(2, \tau, \tau)$  and averages to obtain an estimate of  $\sigma_y^2(\tau)$  as follows:

$$\sigma_y^2(\tau) \approx \frac{1}{2(M-1)} \sum_{k=1}^{M-1} (\bar{y}_{k+1} - \bar{y}_k)^2. \quad (8.13a)$$

It can be shown that the time average of  $\sigma_y^2(2, \tau, \tau)$  is convergent (i.e., as  $M \rightarrow \infty$ ) even for noise processes that do not have convergent  $\langle \sigma_y^2(N, \tau, \tau) \rangle$  as  $N \rightarrow \infty$  (see [1] app. 1). Therefore,  $\sigma_y^2(\tau)$  has greater utility as an idealization than does  $\langle \sigma_y^2(\infty, \tau, \tau) \rangle$  even though both involve assumptions of infinite averages. In effect, increasing  $N$  causes  $\sigma_y^2(N, T, \tau)$  to be more sensitive to the low frequency components of  $S_y(f)$ . In practice, one must distinguish between an experimental estimate of a quantity (say, of  $\sigma_y^2(\tau)$ ) and its idealized value. It is reasonable to believe that extensions to the concept of statistical (“quality”) control [18] may prove useful here. One should, of course, specify the actual number,  $M$ , of independent data samples used for an estimate of  $\sigma_y^2(\tau)$ . Confidence on the estimate has been calculated as a function of  $M$  in ref. [19].

In summary, therefore,  $S_y(f)$  is the proposed measure of (instantaneous) frequency stability in the (Fourier) frequency domain and  $\sigma_y^2(\tau)$  is the proposed measure of frequency stability in the time domain.

### 8.6.3. Distributions

This chapter does not attempt to specify a preferred probability distribution measure for frequency fluctuations. Whereas  $(\bar{y}_{k+1} - \bar{y}_k)$  could be specified as the argument of a distribution function, we prefer to wait until further experience has demonstrated the need for some such specification.

The amplitude probability distribution of the random noise portions of frequency fluctuations is found usually to be Gaussian. See [19] for two examples, one for white noise of phase and one for flicker noise of frequency.

### 8.6.4. Treatment of Systematic Variations

a. *General.* The definition of frequency stability  $\sigma_y^2(\tau)$  in the time domain is useful for many situations. However, some oscillators exhibit an aging or almost linear drift of frequency with time. For some applications, this trend may be calculated and removed [8] before estimating  $\sigma_y^2(\tau)$ .

In general, a systematic trend is perfectly deterministic (i.e., predictable in detail) while the noise is nondeterministic (i.e., predictable only in a statistical sense). Consider a function,  $g(t)$ , which may be written in the form

$$g(t) = c(t) + n(t), \quad (8.14)$$

where  $c(t)$  is some deterministic function of time and  $n(t)$ , the noise, is a nondeterministic function of time. We will define  $c(t)$  to be the *systematic trend* to the function  $g(t)$ . A problem of significance here is the determination of when and in what sense  $c(t)$  is measurable.

b. *Specific Case—Linear Drift.* As an example, if we consider a typical quartz crystal oscillator whose fractional frequency deviation is  $y(t)$ , we may let

$$g(t) = \frac{d}{dt} y(t). \quad (8.15)$$

Let  $c(t)$  be the drift rate of the oscillator (e.g.,  $10^{-10}$  per day) and  $n(t)$  is related to the frequency "noise" of the oscillator by a time derivative. One sees that the time average of  $g(t)$  becomes

$$\frac{1}{T} \int_{t_0}^{t_0+T} g(t) dt = c_1 + \frac{1}{T} \int_{t_0}^{t_0+T} n(t) dt, \quad (8.16)$$

where  $c(t) = c_1$  is assumed to be the constant drift rate of the oscillator. In order for  $c_1$  to be an observable, it is natural to expect the average of the noise term to vanish, that is, converge to zero.

It is instructive to assume [8, 20] that in addition to a linear drift the oscillator is perturbed by a flicker noise frequency modulation (FM), i.e.,

$$S_y(f) = \begin{cases} h_{-1} f^{-1}, & 0 < f \leq f_h \\ 0, & f > f_h, \end{cases} \quad (8.17)$$

where  $h_{-1}$  is a constant (see sec. 8.7.1(b)) and thus,

$$S_n(f) = \begin{cases} (2\pi)^2 h_{-1} f, & 0 \leq f \leq f_h \\ 0, & f > f_h, \end{cases} \quad (8.18)$$

for the oscillator we are considering. With these assumptions, it is seen that

$$\lim_{T \rightarrow \infty} \frac{1}{T} \int_{t_0}^{t_0+T} n(t) dt = \kappa(0) = 0, \quad (8.19)$$

and that

$$\lim_{T \rightarrow 1} \left\{ \text{Variance} \left[ \frac{1}{T} \int_{t_k}^{t_k+T} n(t) dt \right] \right\} = 0, \quad (8.20)$$

where  $\kappa(f)$  is the Fourier transform of  $n(t)$ . Since  $S_n(0) = 0$ ,  $\kappa(0)$  must also vanish both in probability and in mean square. Thus, not only does  $n(t)$  average to zero, but arbitrarily good confidence in the result may be obtained by longer averages.

Having shown that one can reliably estimate the drift rate,  $c_1$ , of this (common) oscillator, it is instructive to attempt to fit a straight line to the frequency aging. That is, let

$$g(t) = y(t), \quad (8.21)$$

and, thus,

$$g(t) = c_0 + c_1(t - t_0) + n'(t), \quad (8.22)$$

where  $c_0$  is the frequency intercept at  $t = t_0$  and  $c_1$  is the drift rate previously determined. A problem arises here because

$$S_{n'}(f) = S_y(f), \quad (8.23)$$

and

$$\lim_{T \rightarrow 1} \left\{ \text{Variance} \left[ \frac{1}{T} \int_{t_k}^{t_k+T} n'(t) dt \right] \right\} = \infty, \quad (8.24)$$

for the noise model we have assumed. This follows from the fact that the (infinite  $N$ ) variance of a flicker noise process is infinite [17, 8, 20]. Thus,  $c_0$  cannot be measured with any realistic precision—at least, in an absolute sense.

We may interpret these results as follows: After experimenting with the oscillator for a period of time one can fit an empirical equation to  $y(t)$  of the form

$$y(t) = c_0 + tc_1 + n'(t), \quad (8.25)$$



where  $n'(t)$  is nondeterministic. At some later time it is possible to reevaluate the coefficients  $c_0$  and  $c_1$ . According to what has been said, the drift rate  $c_1$  should be reproducible to within the confidence estimates of the experiment regardless of when it is reevaluated. For  $c_0$ , however, this is not true. In fact, the more one attempts to evaluate  $c_0$ , the larger are the fluctuations in the result.

Depending on the spectral density of the noise term, it may be possible to predict future measurements of  $c_0$  and to place realistic confidence limits on the prediction [21]. For the case considered here, however, these confidence limits increase when the prediction interval is increased. Thus, in a certain sense,  $c_0$  is "measurable" but it is not in statistical control (to use the language of the quality control engineer [18]).

## 8.7. TRANSLATIONS AMONG FREQUENCY STABILITY MEASURES

### 8.7.1. Frequency Domain to Time Domain

a. *General.* It is of value to define  $r = T/\tau$ ; that is,  $r$  is the ratio of the time interval between successive measurements to the duration of the averaging period. Cutler has shown that ([1] app. I)

$$\langle \sigma_y^2(N, T, \tau) \rangle = \frac{N}{(N-1)} \int_0^\infty df S_y(f) \frac{[\sin^2(\pi f \tau)]}{(\pi f \tau)^2} \left\{ 1 - \frac{\sin^2(\pi r f N \tau)}{N^2 \sin^2(\pi r f \tau)} \right\}. \quad (8.26)$$

Equation (8.26) in principle allows one to calculate the time domain stability  $\langle \sigma_y^2(N, T, \tau) \rangle$  from the frequency domain stability  $S_y(f)$ .

b. *Specific model.* A model which has been found useful [17-22] consists of a set of five independent noise processes,  $z_n(t)$ ,  $n = -2, -1, 0, 1, 2$ , such that

$$y(t) = z_{-2}(t) + z_{-1}(t) + z_0(t) + z_1(t) + z_2(t), \quad (8.27)$$

and the spectral density of  $z_n$  is given by

$$S_{z_n}(f) = \begin{cases} h_n f^n, & 0 \leq f \leq f_h \\ 0, & f > f_h, \end{cases} \quad n = -2, -1, 0, 1, 2, \quad (8.28)$$

where the  $h_n$  are constants. Thus,  $S_y(f)$  becomes

$$S_y(f) = h_{-2} f^{-2} + h_{-1} f^{-1} + h_0 + h_1 f + h_2 f^2, \quad (8.29)$$

for  $0 \leq f \leq f_h$  and  $S_y(f)$  is assumed to be negligible beyond this range. In effect, each  $z_n$  contributes to both  $S_y(f)$  and  $\langle \sigma_y^2(N, T, \tau) \rangle$  independently of the other  $z_n$ . The contributions of the  $z_n$  to  $\langle \sigma_y^2(N, T, \tau) \rangle$  are tabulated in Appendix II of reference [1] (see also table 8.1 in sec. 8.12).

Any electronic device has a finite bandwidth and this certainly applies to frequency measuring equipment also. For fractional frequency fluctuations,  $y(t)$ , whose spectral density varies as

$$S_y(f) \sim f^\alpha, \quad \alpha \geq -1, \quad (8.30)$$

for the higher Fourier components, one sees (from ref. [1], app. I) that  $\langle \sigma_y^2(N, T, \tau) \rangle$  may depend on the exact shape of the frequency cutoff. This is true because a substantial fraction of the noise "power" may be in these higher Fourier components. As a simplifying assumption, this chapter assumes a sharp cutoff in noise "power" at the frequency  $f_h$  for the noise models. It is apparent from the tables in reference [1] (app. II) that the time domain measure of frequency stability may depend on  $f_h$  in a very important way, and, in some practical cases, the actual shape of the frequency cutoff may be very important [17]. On the other hand, there are many practical measurements where the value of  $f_h$  has little or no effect. Good practice, however, dictates that the system noise bandwidth,  $f_h$ , should be specified with any results.

In actual practice, the model of eqs (8.27), (8.28), and (8.29) seems to fit almost all real frequency sources. Typically, only two or three of the  $h$ -coefficients are actually significant for a real device and the others can be neglected. Because of its applicability, this model is used in much of what follows. Since the  $z_n$  are assumed to be independent noises, it is normally sufficient to compute the effects for a general  $z_n$  and recognize that the superposition can be accomplished by simple additions for their contributions to  $S_y(f)$  or  $\langle \sigma_y^2(N, T, \tau) \rangle$ .

### 8.7.2. Time Domain to Frequency Domain

a. *General.* For general  $\langle \sigma_y^2(N, T, \tau) \rangle$  no simple prescription is available for translation into the frequency domain. For this reason, one might prefer  $S_y(f)$  as a general measure of frequency stability. This is especially true for theoretical work.

b. *Specific model.* Equations (8.27), (8.28), and (8.29) form a realistic model which fits the random, nondeterministic noises found on most signal generators. Obviously, if this is a good model, then the tables in reference [1] (app. II) or table 8.1 may be used in reverse to translate into the frequency domain.

Allan [8] and Vessot [22] showed that if

$$S_y(f) = \begin{cases} h_\alpha f^\alpha, & 0 \leq f \leq f_h \\ 0, & f > f_h, \end{cases} \quad (8.31)$$

where  $\alpha$  is a constant, then

$$\langle \sigma_y^2(N, T, \tau) \rangle \sim |\tau|^\mu, \quad 2\pi\tau f_h \gg 1, \quad (8.32)$$

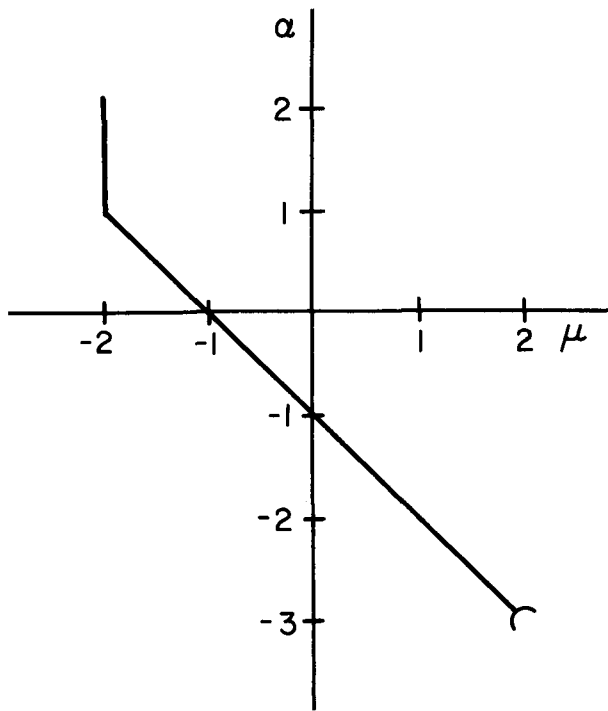

FIGURE 8.1. Mapping of exponents  $\mu - \alpha$  (see eq 8.37).

for  $N$  and  $r \equiv \frac{T}{\tau}$  held constant, and the constant  $\mu$  is related to  $\alpha$  by the mapping shown<sup>3</sup> in figure 8.1. If eqs (8.31) and (8.32) hold over a reasonable range for a signal generator, then eq (8.31) can be substituted into eq (8.26) and evaluated to determine the constant  $h_\alpha$  from measurements of  $\langle \sigma_y^2(N, T, \tau) \rangle$ . It should be noted that the model of eqs (8.31) and (8.32) may be easily extended to a superposition of similar noises as in eq (8.29).

### 8.7.3. Translations Among the Time Domain Measures

a. *General.* Since  $\langle \sigma_y^2(N, T, \tau) \rangle$  is a function of  $N$ ,  $T$ , and  $\tau$  (for some types of noise  $f_h$  is also important), it is very desirable to be able to translate among different sets of  $N$ ,  $T$ , and  $\tau$  ( $f_h$  held constant); this is, however, not possible in general.

b. *Specific model.* It is useful to restrict consideration to a case described by eqs (8.31) and (8.32). Superpositions of independent noises with different power-law types of spectral densities (i.e., different

<sup>3</sup> It should be noted that in Allan [8] the exponent,  $\alpha$ , corresponds to the spectrum of phase fluctuations while variances are taken over average frequency fluctuations. In the present paper,  $\alpha$  is identical to the exponent  $\alpha + 2$  in reference [8].

$\alpha$ 's) can also be treated by this technique, e.g., eq (8.29). One may define two "bias functions,"  $B_1$  and  $B_2$  by the relations [3]:

$$B_1(N, r, \mu) \equiv \frac{\langle \sigma_y^2(N, T, \tau) \rangle}{\langle \sigma_y^2(2, T, \tau) \rangle}, \quad (8.33)$$

and

$$B_2(r, \mu) \equiv \frac{\langle \sigma_y^2(2, T, \tau) \rangle}{\langle \sigma_y^2(2, \tau, \tau) \rangle}, \quad (8.34)$$

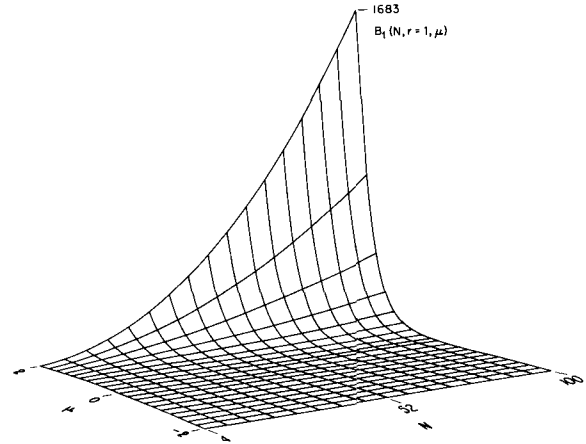

FIGURE 8.2. The bias function,  $B_1(N, r=1, \mu)$ .

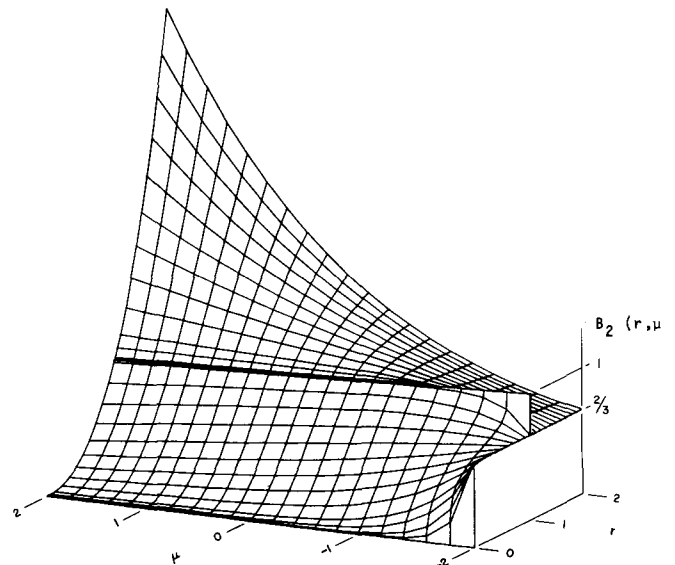

FIGURE 8.3. The bias function,  $B_2(r, \mu)$ .

where  $r \equiv T/\tau$  and  $\mu$  is related to  $\alpha$  by the mapping of figure 8.1. In words,  $B_1$  is the ratio of the average variance for  $N$  samples to the average variance for 2 samples (everything else held constant); while  $B_2$  is the ratio of the average variance with dead time between measurements ( $r \neq 1$ ) to that of no dead time ( $r=1$ ,  $N=2$ , and  $\tau$  held constant). These functions are tabulated in reference [3], and reproduced in Annex 8.J. Figures 8.2 and 8.3 show a computer plot of  $B_1(N, r=1, \mu)$  and  $B_2(r, \mu)$ .

Suppose one has an experimental estimate of  $\langle \sigma_y^2(N_1, T_1, \tau_1) \rangle$  and its spectral type is known—that is, eqs (8.31) and (8.32) form a good model and  $\mu$  is known. Suppose also that one wishes to know the variance at some other set of measurement parameters,  $N_2, T_2, \tau_2$ . An unbiased estimate of  $\langle \sigma_y^2(N_2, T_2, \tau_2) \rangle$  may be calculated by the equation:

$$\langle \sigma_y^2(N_2, T_2, \tau_2) \rangle = \left(\frac{\tau_2}{\tau_1}\right)^\mu \left[ \frac{B_1(N_2, r_2, \mu) B_2(r_2, \mu)}{B_1(N_1, r_1, \mu) B_2(r_1, \mu)} \right] \langle \sigma_y^2(N_1, T_1, \tau_1) \rangle, \quad (8.35)$$

where  $r_1 \equiv T_1/\tau_1$  and  $r_2 \equiv T_2/\tau_2$ .

*c. General-Bias Functions.* While it is true that the concept of the bias functions,  $B_1$  and  $B_2$ , could be extended to other processes besides those with the power-law types of spectral densities, this generalization has not been done. Indeed, spectra of the form given in eq (8.31) (or superpositions of such spectra as in eq (8.29)) seem to be the most common types of non-deterministic noises encountered in signal generators and associated equipment. For other types of fluctuations (such as causally generated perturbations), translations must be handled on an individual basis.

## 8.8. EXAMPLES OF APPLICATIONS OF PREVIOUSLY DEVELOPED MEASURES

### 8.8.1. Applications of Stability Measures

Obviously, if one of the stability measures is exactly the important parameter in the use of a signal generator, the stability measure's application is trivial. Some nontrivial applications arise when one is interested in a different parameter, such as in the use of an oscillator in Doppler radar measurements or in clocks.

#### a. Doppler Radar

(1) *General.* From its transmitted signal, a Doppler radar receives from a moving target a frequency-shifted return signal in the presence of

other large signals. These large signals can include clutter (ground return) and transmitter leakage into the receiver (spillover). Instabilities of radar signals result in noise energy on the clutter return, on spillover, and on local oscillators in the equipment. The limitations of subclutter visibility (SCV) rejections due to the radar signals themselves are related to the RF spectral density,  $S_V(f)$ . The quantity typically referred to is the carrier-to-noise ratio and can be mathematically approximated by the quantity

$$\frac{S_V(f)}{\int_0^\infty S_V(f') df'}$$

(This quantity is actually the noise-to-carrier ratio, but using the reciprocal is more convenient in what follows, and there is little chance for confusion.) The effects of coherence of target return and other radar parameters are amply considered in the literature [23–26].

(2) *Special Case.* Because FM effects generally predominate over AM effects, this carrier-to-noise ratio is approximately given by [16]

$$\frac{S_V(f)}{\int_0^\infty S_V(f') df'} \approx \frac{1}{2} S_\varphi(|f - \nu_0|), \quad (8.36)$$

for many signal sources provided  $|f - \nu_0|$  is sufficiently greater than zero. Thus, if  $f - \nu_0$  is a frequency separation from the carrier, the carrier-to-noise ratio at that point is approximately

$$\frac{1}{2} S_\varphi(|f - \nu_0|) = \frac{1}{2} \left( \frac{\nu_0}{f - \nu_0} \right)^2 S_y(|f - \nu_0|). \quad (8.37)$$

#### b. Clock Errors

(1) *General.* A clock is a device which counts the cycles of a periodic phenomenon. Thus, the reading error  $x(t)$  of a clock run from the signal given by eq (8.4) is

$$x(t) = \frac{\varphi(t)}{2\pi\nu_0}, \quad (8.38)$$

and the dimensions of  $x(t)$  are seconds. If this clock is a secondary standard, one could have a past history of  $x(t)$ , the time error relative to the standard clock. It often occurs that one is interested in predicting the clock error  $x(t)$  for some future date, say  $t_0 + \tau$ , where  $t_0$  is the present date. Obviously, this is a problem in pure prediction and can be handled by conventional methods [13].

(2) *Special Case.* Although one could handle the prediction of clock errors by the rigorous methods of prediction theory, it is more common to use simpler prediction methods [20, 21]. In particular, one often predicts a clock error for the future by adding a correction to the present error; this correction is derived from the current rate of gain (or loss) of time. That is, the predicted error  $\hat{x}(t_0 + \tau)$  is related to the past history of  $x(t)$  by the equation

$$\hat{x}(t_0 + \tau) = x(t_0) + T \left[ \frac{x(t_0) - x(t_0 - T)}{T} \right]. \quad (8.39)$$

As a specific example, let  $T = \tau$ , then the mean-square error of prediction becomes

$$\langle [x(t_0 + \tau) - \hat{x}(t_0 + \tau)]^2 \rangle = \langle [x(t_0 + \tau) - 2x(t_0) + x(t_0 - \tau)]^2 \rangle, \quad (8.40)$$

which, with the aid of eq (8.13), can be written in the form

$$\langle [x(t_0 + \tau) - \hat{x}(t_0 + \tau)]^2 \rangle = 2\tau^2 \sigma_y^2(\tau). \quad (8.41)$$

## 8.9. MEASUREMENT TECHNIQUES FOR FREQUENCY STABILITY

### 8.9.1. Heterodyne Techniques (General)

It is possible for oscillators to be very stable and values of  $\sigma_y(\tau)$  can be as small as  $10^{-14}$  in some state of the art equipment. Thus, one often needs measuring techniques capable of resolving very small fluctuations in  $y(t)$ . One of the most common techniques is a heterodyne or beat frequency technique. In this method, the signal from the oscillator to be tested is mixed with a reference signal of almost the same frequency as the test oscillator; one is left then with a lower average frequency for analysis without reducing the frequency (or phase) fluctuations themselves. Following Vessot et al. [27], consider an ideal reference oscillator whose output signal is

$$V_r(t) = V_{or} \sin 2\pi\nu_0 t, \quad (8.42)$$

and a second oscillator whose output voltage  $V(t)$  is given by eq (8.4):  $V(t) = [V_0 + \epsilon(t)] \sin [2\pi\nu_0 t + \varphi(t)]$ . Let these two signals be mixed in a product detector; that is, the output of the product detector  $v(t)$  is equal to the product  $\gamma V(t) \times V_r(t)$ , where  $\gamma$  is a constant (see fig. 8.4).

Let  $v(t)$ , in turn, be processed by a sharp, low-pass filter with cutoff frequency  $f'_h$  such that

$$0 < f_h < f'_h < \nu_0. \quad (8.43)$$

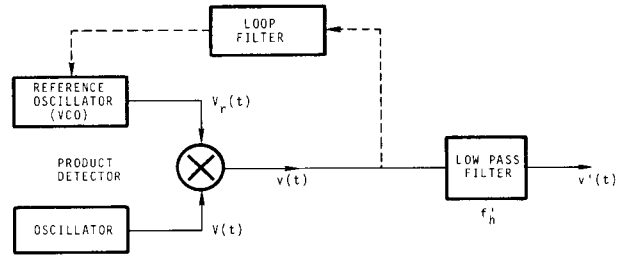

FIGURE 8.4. Example of heterodyne scheme.

One may write

$$\begin{aligned} \gamma V(t) \cdot V_r(t) &= \gamma V_{or} (V_0 + \epsilon) \\ &= v(t) = \gamma \frac{V_{or} V_0}{2} \left( 1 + \frac{\epsilon}{V_0} \right) \\ &= v(t) = \gamma \frac{V_{or} V_0}{2} \left[ \cos \varphi - \cos (2\pi\nu_0 t + \varphi) \right]. \end{aligned} \quad (8.44)$$

Assume that  $\cos[\varphi(t)]$  has essentially no power in Fourier frequencies  $f$  in the region  $f \geq f'_h$ . The effect of the low-pass filter then is to remove the second term on the extreme right of eq (8.44); that is,

$$v'(t) = \gamma \frac{V_{or} V_0}{2} \left( 1 + \frac{\epsilon}{V_0} \right) \cos \varphi(t). \quad (8.45)$$

This separation of terms by the filter is correct only if  $\left| \frac{\dot{\varphi}(t)}{2\pi\nu_0} \right| \ll 1$  for all  $t$  (see eq (8.6)).

The following two cases are of interest:

(a) *Case I*

The relative phase of the oscillators is adjusted so that  $|\varphi(t)| \ll 1$  (in-phase condition) during the period of measurement. Under these conditions

$$v'(t) \approx \frac{\gamma}{2} V_{or} V_0 + \frac{\gamma}{2} V_{or} \epsilon(t), \quad (8.46)$$

since  $\cos \varphi(t) \approx 1$ . That is to say one detects the amplitude noise  $\epsilon(t)$  of the signal.

(b) *Case II*

The relative phase of the oscillators is adjusted to be in approximate quadrature; that is

$$\varphi'(t) = \varphi(t) + \frac{\pi}{2}, \quad (8.47)$$

where  $|\varphi'(t)| \ll 1$ . Under these conditions,

$$\cos \varphi(t) = \sin \varphi'(t) \approx \varphi'(t), \quad (8.48)$$

and

$$v'(t) = \frac{\gamma}{2} V_{or} V_0 \varphi'(t) + \frac{\gamma}{2} V_{or} \varphi'(t) \epsilon(t). \quad (8.49)$$

If it is true that  $\left| \frac{\epsilon(t)}{V_0} \right| \ll 1$  for all  $t$  (see eq (8.5)), then eq (8.49) becomes

$$v'(t) \approx \frac{\gamma}{2} V_{or} V_0 \varphi'(t); \quad (8.50)$$

that is,  $v'(t)$  is proportional to the phase fluctuations. Thus, in order to observe  $\varphi'(t)$  by this method, eqs (8.5) and (8.6) must be valid. For different average phase values, mixtures of amplitude and phase noise are observed.

To maintain the two signals in quadrature for long observational periods, one can use a voltage controlled oscillator (VCO) for a reference and feed back the phase error voltage (as defined in eq (8.50)) to control the frequency of the VCO [28]. In this condition of the phase-locked oscillator, the voltage  $v'(t)$  is the analog of the *phase* fluctuations for Fourier frequencies above the loop cutoff frequency of the locked loop. For Fourier frequencies below the loop cutoff frequency,  $v'(t)$  is the analog of *frequency* fluctuations. In practice, one should measure the complete servo loop response.

### 8.9.2. Period Measurement

Assume one has an oscillator whose voltage output may be represented by eq (8.4). If  $\left| \frac{\epsilon(t)}{V_0} \right| \ll 1$  for all  $t$  and the total phase

$$\Phi(t) = 2\pi\nu_0 t + \varphi(t), \quad (8.7)$$

is a monotonic function of time (that is,  $\left| \frac{\dot{\Phi}(t)}{2\pi\nu_0} \right| \leq 1$ ), then the time  $t$  between successive positive-going zero crossings of  $V(t)$  is related to the average frequency during the interval,  $\tau$ ; specifically,

$$\frac{1}{\tau} = \nu_0(1 + \bar{y}_n). \quad (8.51)$$

If one lets  $\tau$  be the time between a positive going zero crossing of  $V(t)$  and the  $M$ th successive positive going zero crossing, then

$$\frac{M}{\tau} = \nu_0(1 + \bar{y}_n). \quad (8.52)$$

If the variations  $\Delta\tau$  of the period are small compared to the average period  $\tau_0$ , Cutler and Searle

[17] have shown that one may make a reasonable approximation to  $\langle \sigma_y^2(N, T, \tau_0) \rangle$  using period measurements.

### 8.9.3. Period Measurement with Heterodyning

Suppose that  $\varphi(t)$  is a monotonic function of time. The output of the filter of Section 8.9.1, eq (8.45) becomes

$$v'(t) \approx \gamma \frac{V_{or} V_0}{2} \cos \varphi(t), \quad (8.53)$$

if  $\left| \frac{\epsilon(t)}{V_0} \right| \ll 1$ . Then one may measure the period  $\tau$  of two successive positive zero crossings of  $v'(t)$ . Thus

$$\frac{1}{\tau} = \nu_0 |\bar{y}_n|, \quad (8.54)$$

and for the  $M$ th positive crossover

$$\frac{M}{\tau} = \nu_0 |\bar{y}_n|. \quad (8.55)$$

The magnitude bars appear because  $\cos \varphi(t)$  is an even function of  $\varphi(t)$ . It is impossible to determine by this method alone whether  $\varphi$  is increasing or decreasing with time. Since  $\bar{y}_n$  may be very small ( $\sim 10^{-11}$  or  $10^{-12}$  for very good oscillators),  $\tau$  may be quite long and thus measurable with a good relative precision. If the phase,  $\varphi(t)$ , is not monotonic, the true  $y_n$  may be near zero but one could still have many zeros of  $\cos \varphi(t)$  and thus eqs (8.54) and (8.55) would not be valid.

### 8.9.4. Frequency Counters

Assume the phase (either  $\Phi$  or  $\varphi$ ) is a monotonic function of time. If one counts the number  $M$  of positive going zero crossings in a period of time  $\tau$ , then the average frequency of the signal is  $\frac{M}{\tau}$ . If we assume that the signal is  $V(t)$  (as defined in eq (8.4)), then

$$\frac{M}{\tau} = \nu_0(1 + \bar{y}_n). \quad (8.56)$$

If we assume that the signal is  $v'(t)$  (as defined in eq (8.50)), then

$$\frac{M}{\tau} = \nu_0 |\bar{y}_n|. \quad (8.57)$$

Again, one measures only positive frequencies.

### 8.9.5. Frequency Discriminators

A frequency discriminator is a device which converts frequency fluctuations into analog voltage fluctuations by means of a dispersive element. For example, by slightly detuning a resonant circuit from the signal  $V(t)$  the frequency fluctuations  $\frac{1}{2\pi} \dot{\phi}(t)$  are converted to amplitude fluctuations of the output signal. Provided the input amplitude fluctuations  $\frac{\epsilon(t)}{V_0}$  are insignificant, the output amplitude fluctuations can be a good measure of the frequency fluctuations. Obviously, more sophisticated frequency discriminators exist (e.g., the cesium beam). From the analog voltage one may use analog spectrum analyzers to determine  $S_y(f)$ , the frequency stability. By converting to digital data, other analyses are possible on a computer.

### 8.9.6. Common Hazards

#### a. Errors caused by signal processing equipment.

The intent of most frequency stability measurements is to evaluate the source and not the measuring equipment. Thus, one must know the performance of the measuring system. Of obvious importance are such aspects of the measuring equipment as noise level, dynamic range, resolution (dead time), and frequency range.

It has been pointed out that the noise bandwidth  $f_h$  is very essential for the mathematical convergence of certain expressions. Insofar as one wants to measure the signal source, one must know that the measuring system is not limiting the frequency response. At the very least, one must recognize that the frequency limit of the measuring system may be a very important, implicit parameter for either  $\sigma_y^2(t)$  or  $S_y(f)$ . Indeed, one must account for any deviations of the measuring system from ideality such as a "non-flat" frequency response of the spectrum analyzer itself.

Almost any electronic circuit which processes a signal will, to some extent, convert amplitude fluctuations at the input terminals into phase fluctuations at the output. Thus, AM noise at the input will cause a time-varying phase (or FM noise) at the output. This can impose important constraints on limiters and automatic gain control (AGC) circuits when good frequency stability is needed. Similarly, this imposes constraints on equipment used for frequency stability measurements.

b. *Analog spectrum analyzers (Frequency Domain).* Typical analog spectrum analyzers are very similar in design to radio receivers of the super-heterodyne type, and thus certain design features are quite similar. For example, image rejection (related to predetection bandwidth) is very

important. Similarly, the actual shape of the analyzer's frequency window is important since this affects spectral resolution. As with receivers, dynamic range can be critical for the analysis of weak signals in the presence of substantial power in relatively narrow bandwidths (e.g., 60 Hz).

The slewing rate of the analyzer must be consistent with the analyzer's frequency window and the post-detection bandwidth. If one has a frequency window of 1 hertz, one cannot reliably estimate the intensity of a bright line unless the slewing rate is much slower than 1 hertz/second. Additional post-detection filtering will further reduce the maximum usable slewing rate.

c. *Spectral density estimation from time domain data.* It is beyond the scope of this paper to present a comprehensive list of hazards for spectral density estimation; one should consult the literature [12–15]. There are a few points, however, which are worthy of special notice:

- (1) Data aliasing (similar to predetection bandwidth problems);
- (2) spectral resolution; and
- (3) confidence of the estimate.

#### d. Variances of frequency fluctuations, $\sigma_y^2(\tau)$ .

It is not uncommon to have discrete frequency modulation of a source such as that associated with the power supply frequencies. The existence of discrete frequencies in  $S_y(f)$  can cause  $\sigma_y^2(\tau)$  to be a very rapidly changing function of  $\tau$ . An interesting situation results when  $\tau$  is an exact multiple of the period of the modulation frequency (e.g., one makes  $\tau = 1$  second, and there exists 60-Hz frequency modulation on the signal). In this situation,  $\sigma_y^2(\tau = 1s)$  can be very small relative to values with slightly different values of  $\tau$ . One also must be concerned with the convergence properties of  $\sigma_y^2(\tau)$  since not all noise processes will have finite limits to the estimates of  $\sigma_y^2(\tau)$  (see ref. [1], app. I). One must be as critically aware of any "dead time" in the measurement process as of the system bandwidth.

e. *Signal source and loading.* In measuring frequency stability one should specify the exact location in the circuit from which the signal is obtained and the nature of the load used. It is obvious that the transfer characteristics of the device being specified will depend on the load and that the measured frequency stability might be affected. If the load itself is not constant during the measurements, one expects large effects on frequency stability.

f. *Confidence of the estimate.* As with any measurement in science, one wants to know the confidence to assign to numerical results. Thus, when one measures  $S_y(f)$  or  $\sigma_y^2(\tau)$ , it is important to know the accuracies of these estimates.

(1) *The Allan variance* [8]. It is apparent that a single sample variance, e.g.,  $\sigma_y^2(2, \tau, \tau)$ , does not

have good confidence, but by averaging many samples, one can improve greatly the accuracy of the estimate. A detailed discussion of the confidence of the estimate for finite data lengths is given in reference [19]. It has been shown that the infinite average of a set of samples of  $\sigma_y^2(N, T, \tau)$  converges for all power law spectral densities as given in eq (8.31) where  $\alpha > -3$  [1]. It is worth noting that if we were interested in  $\sigma_y^2(N=\infty, T, \tau)$ , then convergence only occurs for  $\alpha > -1$  [1-3]. Since most real signal generators possess low frequency divergent noises in the range  $-1 \geq \alpha > -3$ ,  $\langle \sigma_y^2(N, T, \tau) \rangle$  is more useful than the classical variance,  $\sigma_y^2(N=\infty, T, \tau)$ .

Although the sample variances,  $\sigma_y^2(2, \tau, \tau)$ , will not be normally distributed, the variance of the average of  $M$  independent (nonoverlapping) samples of  $\sigma_y^2(2, \tau, \tau)$  (i.e., the variance estimate of this particular Allan variance) will decrease as  $1/M$  provided the conditions on low frequency divergence are met. For sufficiently large  $M$ , the distribution of the  $M$ -sample-averages of  $\sigma_y^2(2, \tau, \tau)$  will tend toward normal (central limit theorem). It is, thus, possible to estimate confidence intervals based on the normal distribution [19].

As always, one may be interested in  $\tau$ -values approaching the limits of available data. Clearly, when one is interested in  $\tau$ -values of the order of a year, one is severely limited in the size of  $M$  the number of samples of  $\sigma_y^2(2, \tau, \tau)$ . Unfortunately, there seems to be no substitute for many samples and one extends  $\tau$  at the expense of confidence in the results. "Truth in packaging" dictates that the sample size  $M$  be stated with the results.

(2) *Spectral density.* As before, one is referred to the literature for discussions of spectrum estimation [12-15]. It is worth pointing out, however, that for  $S_y(f)$  there are basically two different types of averaging which can be employed: sample averaging of independent estimates of  $S_y(f)$  and frequency averaging where the resolution bandwidth is made much greater than the reciprocal data length.

## 8.10. SUMMARY OF FREQUENCY STABILITY MEASURES

A good measure of frequency stability is the spectral density,  $S_y(f)$ , of fractional frequency fluctuations,  $y(t)$ . An alternative is the expected variance of  $N$  sample averages of  $y(t)$  each taken over a duration  $\tau$ . With the beginning of successive sample periods spaced every  $T$  units of time, the variance is denoted by  $\sigma_y^2(N, T, \tau)$ . The preferred time domain stability measure, is the expected value of many measurements of  $\sigma_y^2(N, T, \tau)$ , with  $N = 2$  and  $T = \tau$ , defined as  $\sigma_y^2(\tau)$ . For all real experiments one has a finite bandwidth. In general, the time domain measure of frequency stability,  $\sigma_y^2(\tau)$ , is dependent on the noise bandwidth of the system. Thus, there are four important parameters to the time domain measure of frequency stability:

- $N$ , the number of sample averages ( $N = 2$  for preferred measure);
- $T$ , the repetition time for successive sample averages ( $T = \tau$  for preferred measure);
- $\tau$ , the duration of each sample average; and
- $f_h$ , the system noise bandwidth.

Translations among the various stability measures for common noise types are possible, but there are significant reasons for choosing  $N = 2$  and  $T = \tau$  for the preferred measure of frequency stability in the time domain. This measure, the Allan variance for  $N = 2$  and  $T = \tau$ , has been referenced by [19, 22, 29-31] among others. Although  $S_y(f)$  appears to be a function of the single variable  $f$ , actual experimental estimation procedures for the spectral density involve a great many parameters. Indeed, its experimental estimation can be as involved as the estimation of  $\sigma_y^2(\tau)$ .

## 8.11. PRACTICAL APPLICATIONS OF FREQUENCY STABILITY SPECIFICATION AND MEASUREMENT

Up to this point we have considered principally the statistical theory of time and frequency data analysis showing general applications of stability measures. We would now like to show practical laboratory examples to establish standards of terminology and measurement techniques for frequency stability. Emphasis is placed on *details of useful working systems* (apparatus) that could be duplicated by others in the field of frequency stability measurements. Uniformity of data presentation is stressed to facilitate interpretation of stability specifications and to enable one to communicate and compare experimental results on a common base. This part of the chapter is based primarily on the theory given in Sections 8.1-8.10 and the paper by Barnes et al. [1]. We review the terminology for specification of frequency stability and describe the performance of frequency stability measurement systems capable of precise measurements on state-of-the-art sources in both the High Frequency (HF) and Microwave (X-band) regions.

## 8.12. TERMINOLOGY FOR SPECIFICATION OF FREQUENCY STABILITY

The term *frequency stability* encompasses the concepts of random noise, intended and incidental modulation, and any other fluctuations of the output frequency of a device. (In a very loose sense frequency stability can be considered as the degree to which a signal source (e.g., oscillator) produces

the same frequency throughout a specified period of time.) In this chapter we are mainly (but not totally) concerned with random fluctuations corresponding to Fourier frequencies in the  $10^0$  to  $10^6$  hertz range. The measurement of frequency stability can be accomplished in both the frequency domain (e.g., spectrum analysis) and the time domain (e.g., gated frequency counter). Previously, in Section 8.6, we described two independent definitions, each related to different but useful measurement methods.

The first definition of *frequency stability* (*frequency domain*) is the one-sided spectral density of the fractional frequency fluctuations,  $S_y(f)$ , where  $y \equiv \delta\nu/\nu_0$  (see ann. 8.A for glossary which defines symbols). The fractional frequency fluctuation spectral density  $S_y(f)$  is not to be confused with the radio frequency power spectral density  $S_{\sqrt{\text{RFP}}}(\nu)$ , or  $S_{\delta\nu}(\nu)$ , which is *not* a good primary measure of frequency stability because of fluctuations in amplitude and for other reasons (see sec. 8.6

and ref. [32]). Phase noise spectral density plots (i.e.,  $S_{\delta\phi}(f)$  versus  $f$ ) are a common alternative method of data presentation. The spectral density of phase fluctuations is related to  $S_y(f)$  by

$$S_{\delta\phi}(f) = [\nu_0^2/f^2] S_y(f). \quad (8.58)$$

The second definition of *frequency stability* (*time domain*) uses the type of sample variance called the Allan variance [8] of  $y$ :

$$\langle \sigma_y^2(N, T, \tau, f_h) \rangle \equiv \left\langle \frac{1}{N-1} \sum_{n=1}^N \left( \bar{y}_n - \frac{1}{N} \sum_{k=1}^N \bar{y}_k \right)^2 \right\rangle. \quad (8.59)$$

Note: Equation (8.59) is identical to eq (8.12) except that the measurement system bandwidth,  $f_h$ , has been explicitly inserted in the parenthesis on the left. The particular Allan variance with  $N = 2$  and  $T = \tau$  is found to be especially useful in practice.

TABLE 8.1. Stability measure conversion chart\* (frequency domain-time domain).

$S_y(f)$  = one-sided spectral density of  $y$  (dimensions are  $y^2/f$ ),  $0 \leq f \leq f_h$ ,  $f_h \equiv B$ ,  $2\pi f_h \tau \gg 1$ ;  $S_y(f \geq f_h) = 0$   
 General Definition:  $\langle \sigma_y^2(N, T, \tau, f_h) \rangle \equiv \left\langle \frac{1}{N-1} \sum_{n=1}^N \left( \bar{y}_n - \frac{1}{N} \sum_{k=1}^N \bar{y}_k \right)^2 \right\rangle$ ,  $\frac{dx}{dt} \equiv y \equiv \frac{\delta\nu}{\nu_0}$ ,  $r \equiv \frac{T}{\tau}$   
 Special Case:  $\sigma_y^2(\tau) \equiv \langle \sigma_y^2(N=2, T=\tau, \tau, f_h) \rangle = \left\langle \frac{(\bar{y}_{k+1} - \bar{y}_k)^2}{2} \right\rangle$   
 Useful Relationships:  
 $(2\pi)^2 = 39.48$   
 $\ln 2 = 0.693$   
 $2 \ln 2 = 1.386$   
 $\ln 10 = 2.303$

Time Domain (Allan variances...)	$\sigma_y^2(\tau)$ [N = 2, r = 1]	$\langle \sigma_y^2(N, T = \tau, \tau, f_h) \rangle$ [r = 1]	$\langle \sigma_y^2(N, T, \tau, f_h) \rangle$
Frequency Domain (Power law spectral densities)			
<b>WHITE x</b> $S_y(f) = h_2 f^2$ ( $S_x(f) = \frac{h_2}{(2\pi)^2}$ ) $2\pi f_h \tau \gg 1$	$h_2 \cdot \frac{3f_h}{(2\pi)^2 \tau^2}$	$h_2 \cdot \frac{N+1}{N(2\pi)^2} \cdot \frac{2f_h}{\tau^2}$	$h_2 \cdot \frac{N + \delta_k(r-1)}{N(2\pi)^2} \cdot \frac{2f_h}{\tau^2}$ $\delta_k(r-1) \equiv \begin{cases} 1 & \text{if } r = 1, \\ 0 & \text{otherwise} \end{cases}$
<b>FLICKER x</b> $S_y(f) = h_1 f$ ( $S_x(f) = \frac{h_1}{(2\pi)^2}$ ) $2\pi f_h \tau \gg 1, 2\pi f_h T \gg 1$	$h_1 \cdot \frac{1}{\tau^2 (2\pi)^2} \left[ \frac{9}{2} + 3 \ln(2\pi f_h \tau) - \ln 2 \right]$	$h_1 \cdot \frac{2(N+1)}{N\tau^2 (2\pi)^2} \left[ \frac{3}{2} + \ln(2\pi f_h \tau) - \frac{\ln N}{N^2 - 1} \right]$	$h_1 \cdot \frac{2}{(2\pi\tau)^2} \left[ \frac{3}{2} + \ln(2\pi f_h \tau) \right]$ $+ \frac{1}{N(N-1)} \sum_{n=1}^{N-1} (N-n) \cdot \ln \left[ \frac{n^2 r^2}{2(n^2 - 1)} \right]$ , for $r \gg 1$
<b>WHITE y (Random Walk x)</b> $S_y(f) = h_0$ ( $S_x(f) = \frac{h_0}{(2\pi)^2 f^2}$ )	$h_0 \cdot \frac{1}{2} \tau^{-1}$	$h_0 \cdot \frac{1}{2} \tau^{-1}$	$h_0 \cdot \frac{1}{2} \tau^{-1}$ , for $r \geq 1$ $h_0 \cdot \frac{1}{6} r(N+1) \tau^{-1}$ , for $Nr \leq 1$
<b>FLICKER y</b> $S_y(f) = \frac{h_{-1}}{f}$ ( $S_x(f) = \frac{h_{-1}}{(2\pi)^2 f^3}$ )	$h_{-1} \cdot 2 \ln 2$	$h_{-1} \cdot \frac{N \ln N}{N-1}$	$h_{-1} \cdot \frac{1}{N(N-1)} \sum_{n=1}^{N-1} (N-n) \left[ -2(nr)^2 \ln(nr) \right]$ $+ (nr+1)^2 \ln(nr+1) + (nr-1)^2 \ln nr-1 $
<b>RANDOM WALK y</b> $S_y(f) = \frac{h_{-2}}{f^2}$ ( $S_x(f) = \frac{h_{-2}}{(2\pi)^2 f^4}$ )	$h_{-2} \cdot \frac{(2\pi)^2 \tau}{6}$	$h_{-2} \cdot \frac{(2\pi)^2 \tau}{12} \cdot N$	$h_{-2} \cdot \frac{(2\pi)^2 \tau}{12} [r(N+1) - 1]$ , $r \geq 1$

\*Adapted from J. A. Barnes et al., "Characterization of Frequency Stability," NBS Technical Note 394 (October 1970); also published in IEEE Trans. on Instrumentation and Measurement **IM-20**, No. 2, pp. 105-120 (May 1971).

John H. Shoaf, 273.04  
National Bureau of Standards  
February 1973



This dimensionless measure of stability is denoted by:

$$\sigma_y^2(\tau) \equiv \langle \sigma_y^2(N=2, T=\tau, \tau, f_n) \rangle = \left\langle \frac{(\bar{y}_{k+1} - \bar{y}_k)^2}{2} \right\rangle. \quad (8.60)$$

By way of review, the bar over the  $y$  indicates that  $y$  has been averaged over a time interval  $\tau$ ; the angular brackets indicate an average of the quantity over time. In the time domain we are concerned with a measure of the square root of each side of eq (8.59) over different time intervals. Plots of  $\sigma_y(\tau)$  versus  $\tau$  ("sigma versus tau") on a log-log scale are commonly used for data presentation. A convenient chart which enables one to translate from frequency domain measures to time domain measures (and often conversely) is given in table 8.1. An example of this translation is shown in Annex 8.B.

An additional frequency domain measure of phase fluctuations (noise, instability, modulation) used in the Time and Frequency Division (T&FD) at NBS is called *Script L(f)*. *Script L(f)* is defined as the ratio of the power in one phase modulation sideband (referred to the input carrier frequency, on a spectral density basis) to the total signal power, at Fourier frequency  $f$  from the signal's average frequency  $\nu_0$ , for a single specified signal or device (see ann. 8.C); i.e.,:

$$\mathcal{L}(f) \equiv \frac{\text{Power density (one phase modulation sideband)}}{\text{Power (total signal)}}. \quad (8.61)$$

For small  $\delta\phi$ ,

$$S_{\delta\phi}(f) = 2\mathcal{L}(f). \quad (8.62)$$

A practical system for the measurement of  $\mathcal{L}(f)$  or  $S_{\delta\phi}(f)$  is described later in Section 8.14.1.

In all known signal sources the output frequency is affected by noises of various types. The random noises [1] include white thermal and shot noises, flicker noise, and integrals of these noises. The noises can be characterized by their frequency dependence as shown in table 8.2. It is the examination of these noise spectra with which we are concerned in the analysis of the frequency stability.

Frequency drift is defined as a systematic (non-random, typically-linear) increase or decrease of frequency with time. This is characterized as "aging rate" in crystal oscillators and is expressed in fractional parts per period of time. This section on frequency stability does *not* include a discussion of the so-called "linear drift."

TABLE 8.2. Frequency dependence of various noise types

Noise type	Frequency dependence	
	Spectral density - phase fluctuations <sup>1</sup>	Spectral density - frequency fluctuations <sup>2</sup>
White phase noise.....	$f^0$	$f^2$
Flicker phase noise.....	$f^{-1}$	$f^1$
White frequency noise (random walk of phase).....	$f^{-2}$	$f^0$
Flicker frequency noise.....	$f^{-3}$	$f^{-1}$

<sup>1</sup> i.e.,  $S_{\delta\phi}(f)$ .

<sup>2</sup> i.e.,  $S_{\delta\nu}(f) = f^2 S_{\delta\phi}(f) = \nu_0^2 S_y(f)$ .

### 8.13. COMPARISON OF MEASUREMENT TECHNIQUES

In this discussion, the primary concern is the measurement of frequency fluctuations, i.e., *instability* or *stability* and not the accuracy of a frequency. It is sometimes convenient to refer to the instability as fractional frequency deviation. The measurement of frequency fluctuations can be accomplished by one or more of several methods. In each method it is essential to use a precise reference which is stable in time. In the case of measuring accurate frequency sources an equally excellent reference source is needed.

A straight forward method is by *direct counting of frequency* (cycles) by means of counters. Here, successive values of frequency are read out directly and can be recorded. (The reference signal controls the counter gate.) Statistical analysis of the results are usually made. When measuring the lower frequencies, high resolution is not possible by this method unless frequency multiplication is used. There are at least two disadvantages of frequency multipliers: a pair of specialized multiplier chains may be needed for each different carrier frequency range and noise from the multiplier itself may be introduced.

Another method involves *mixing the two frequencies and recording the beat or difference frequency*. When the reference and signal frequencies are close in value, this requires determination of the fluctuations in very long beat periods. A quantitative measure of short-term frequency stability is not practical in this case. However, when a large offset frequency is introduced, the method is feasible for assessing stability when a readout device, such as a period counter, is used for observing fluctuations.

A somewhat similar method uses a *phase sensitive detector for determining phase fluctuations* between two signals which are approximately in phase quadrature (and hence must be at the same frequency).

Short-term (or long-term) phase fluctuations may be recorded. In order to facilitate statistical analysis it is advantageous to use an analog-to-digital converter and a printout type counter. This method is related to the NBS system (time domain) which is described in detail in Section 8.14.2.

An interesting and rapid method for comparison of frequencies and also applicable to stability measurement (time domain) is the commercially available *frequency error expander*. Since frequency multiplication is used, the same disadvantages are present as in the first method in which multipliers are employed. The error expander synthesizes one of the signals to a convenient offset frequency which is then mixed and multiplied in stages to obtain higher and higher resolution. Eventually, however, the region is reached where the noise becomes excessive and frequency comparison is no longer possible.

Note that *none* of the above-mentioned conventional methods of measuring frequency stability utilize frequency domain techniques. As indicated previously, we prefer that the measurements involve *both* frequency and time domain techniques for a comprehensive and sufficient indication of frequency stability. This is recommended even though it is possible to compute time domain performance from frequency domain results and often conversely [1]. Table 8.1 shows translation from one domain to the other. At least one manufacturer has made it convenient to determine frequency stability in the time domain automatically through computer programming [33, 34]. Others in the frequency and time community outside NBS have reported on excellent systems for both frequency and time domain measurements of frequency stability [17, 35-37]. In principle, some of these resemble the systems used at NBS; the techniques described by Van Duzer [35] and Meyer [36] are excellent examples. Fortunately, frequency domain and time domain methods for measuring frequency stability require similar apparatus with the following exceptions: frequency domain measurements require a frequency window (spectrum analyzer) following the detector; for time domain measurements a time window (gated counter) must follow the detector. We next describe specific operating procedures at NBS utilizing the aforementioned techniques.

## 8.14. OPERATIONAL SYSTEMS FOR MEASUREMENT OF FREQUENCY STABILITY AT NBS (HIGH FREQUENCY REGION)

Until recently, most conventional systems for measurement of frequency stability primarily have utilized time domain techniques; however, a complete measure of frequency stability requires use of both frequency and time domain techniques. The introduction of good double-balanced mixers

permitted measurement of frequency stability by improved techniques [35-38]. The double-balanced mixer, considered as a phase sensitive detector, provides meaningful frequency stability measurements of high-quality signal sources in both the frequency domain and the time domain. The results are quantitative and may be obtained from a measurement system which is reasonable in cost. The frequency stability measurement systems described below have been used at NBS since 1967 for measurements in the HF region. The functional block diagrams in figures 8.5, 8.11, and 8.13 are referred to in the detailed descriptions of the particular systems. The carrier frequency range  $10^3$  Hz to  $10^9$  Hz, and higher, is easily covered with these techniques.

### 8.14.1. Frequency Domain Measurements

Figure 8.5 illustrates our measurement system typically used for *frequency domain* measurements; it should be noted also that time domain data can be obtained simultaneously, although that is not often done. (For time domain measurements it is often more convenient to use a slightly modified measurement setup described in Section 8.14.2.) In the frequency domain setup of figure 8.5, the oscillator signal under test (A), is fed into one side of a low-noise double-balanced mixer (D) which utilizes Schottky barrier diodes. The other side of the mixer is the reference oscillator signal (B), attenuated about 10 dB by pad (C) shown in figure 8.5. The mixer acts as a phase sensitive detector; when the two signals are identical in frequency and in phase-quadrature, the output is approximately zero volts dc. When this output is returned to the reference

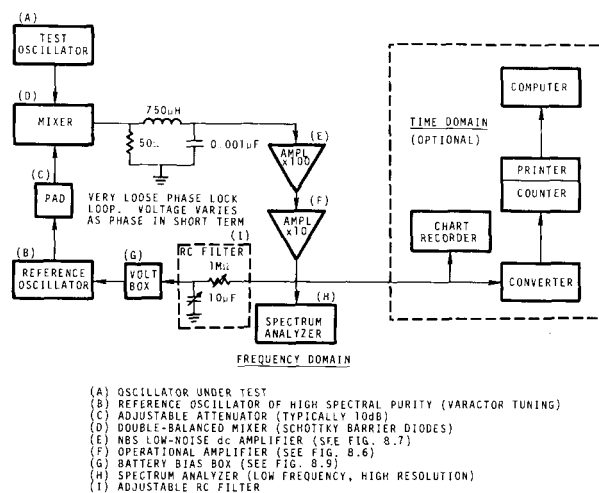

FIGURE 8.5. Typical frequency domain measurement of frequency stability (phase sensitive mode).

oscillator via the varactor tuning, phase lock is achieved. The phase lock loop contains proper termination at the output of the mixer followed by operational amplifiers (E, F) with adjustable gain. The time constant of the loop may be adjusted as needed by varying the amplifier gain within the loop and to a lesser extent, by use of the RC filter<sup>4</sup> (I) indicated in the diagram of figure 8.5. Finally, a battery bias box (G) is included at the varactor input to insure operation in a suitably linear portion of the varactor's frequency versus voltage curve.

A *very loose phase lock loop* is indicated inasmuch as the voltage varies as phase (in short term), and in this frequency domain measurement we are observing the small phase variations directly. The phrase—*very loose phase lock loop*—means that the bandwidth of the servo response is small compared to the lowest frequency,  $f$ , at which we wish to measure (i.e., the response time is very slow). For convenience in adjusting the gain and the advantage of a self-contained battery supply voltage we use operational amplifiers (stepped gain-commercial) as arranged in the circuit shown in figure 8.6. Special NBS low-noise dc amplifiers used in certain precision measurements are shown in figure 8.7. At NBS we have arranged the adjustable RC or CR filters in a small chassis according to the diagram of figure 8.8; we utilize low-noise components, and rotary switches provide various combinations of R and C. The battery bias box (shown in fig. 8.9) is arranged with a vernier, thus facilitating fine frequency adjustments via the varactor frequency adjustment in one oscillator. A commercial wave analyzer provides the noise plot information relevant to stability (frequency domain). The phase noise sideband levels are read out in rms volts on the analyzer, set to certain chosen values of frequency,  $f$ . For typical high quality signal sources, this corresponds to measuring only those phase noise sidebands which are separated from the carrier by the various  $f$  intervals chosen. Script  $\mathcal{L}(f)$

<sup>4</sup> This filter can cause instabilities if its time constant, RC, is too large.

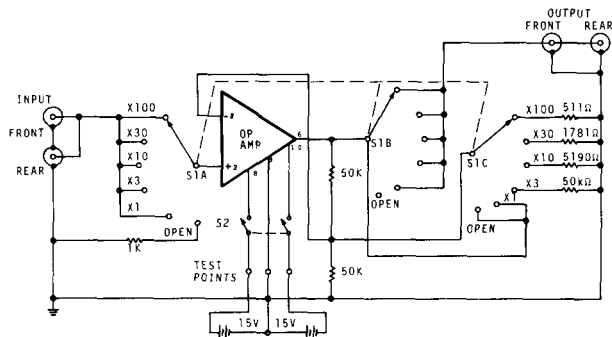

FIGURE 8.6. Stepped-gain operational amplifier.

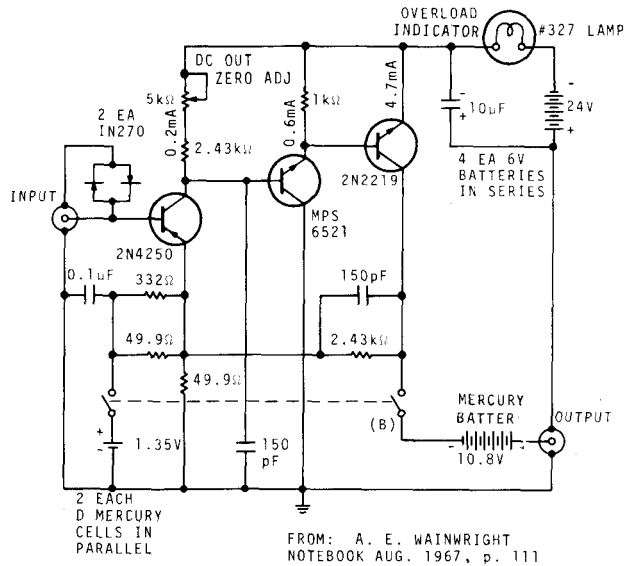
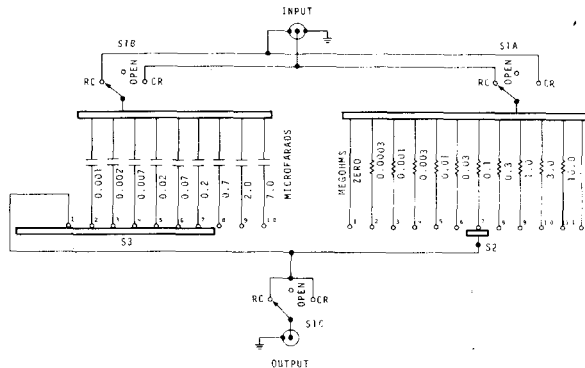
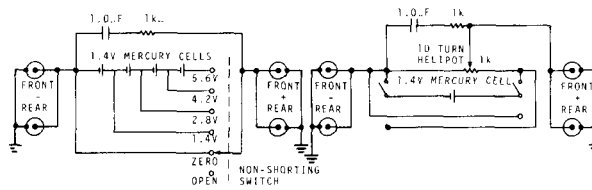

FIGURE 8.7. Low noise amplifier.



- S1: FILTER MODE SWITCH (ROTARY, 3 WAFER)
- S2: RESISTOR SWITCH (ROTARY, SHORTING TYPE)
- S3: CAPACITOR SWITCH (ROTARY, PROGRESSIVE SHORTING)

FIGURE 8.8. Adjustable RC filter.



THE UNITS ARE BUILT ON SEPARATE CHASSIS AND CONNECTED IN SERIES TO FACILITATE FINE ADJUSTMENT BETWEEN STEP VOLTAGES

FIGURE 8.9. Battery bias box.

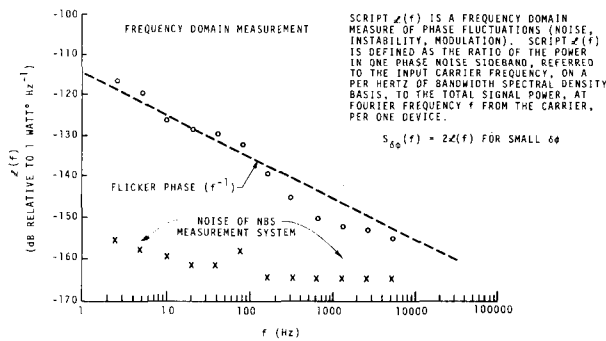
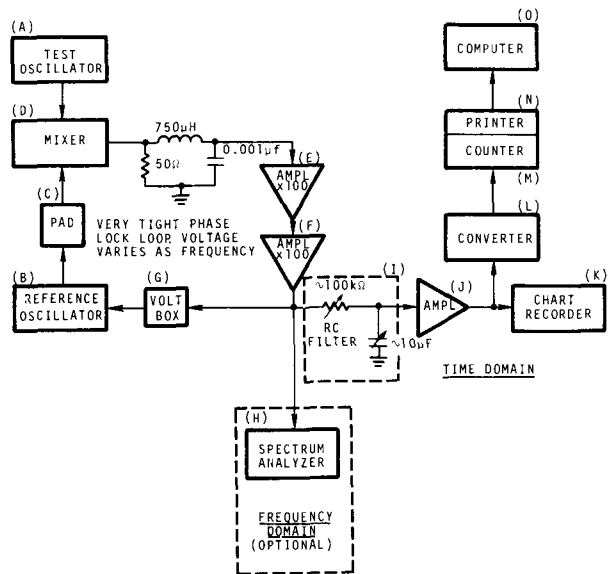

FIGURE 8.10. Script  $\mathcal{L}(f)$  versus frequency  $f$ .

may be calculated with the assumption that both oscillator sources contribute equally; however, if one source were the major contributor, then the noise of that source would be no worse than 3 dB greater than the value of  $\mathcal{L}(f)$  so calculated. A typical plot of script  $\mathcal{L}(f)$  versus frequency is shown in figure 8.10; a sample calculation is given in Annex 8.D.

### 8.14.2. Time Domain Measurements

Figure 8.11 shows a measurement system typically used at NBS for stability measurements in the *time domain*. Note that the principle of operation is similar to that used in the frequency domain measurement wherein the reference oscillator is locked to the test oscillator. However, for the time domain measurement we use a *very tight phase lock loop* and the correction voltage at the oscillator varies as frequency. The phrase—*very tight phase lock loop*—means that the bandwidth of the servo response is relatively large (i.e., the response time is much smaller than the smallest time interval,  $\tau$ , at which we wish to measure). This is a very convenient system for observing frequency fluctuations in longer term. However, with the time constant appropriately adjusted and the means for taking sufficiently short samples, the system is readily used for both short and long term measurements in the time domain. For qualitative observations any suitable oscilloscope or strip chart recorder may be used. For quantitative measurements the system at NBS utilizes a voltage-to-frequency converter, a frequency counter, and a printer capable of recording rapid samples of data with very short dead time. The data are analyzed typically by computer via a program designed to compute the appropriate Allan variance [1, 8]. In our computer program  $\log \langle \sigma_y^2(N, T, \tau, f_h) \rangle^{1/2}$  versus  $\log \tau$  ( $\sigma$  versus  $\tau$ ) along with the associated confidence in sigma are automatically plotted on microfilm. For small batches of



ITEMS (A) THROUGH (I) SIMILAR TO FIGURE 8.5.  
 (J) OPERATIONAL AMPLIFIER  
 (K) STRIP CHART RECORDER FOR QUALITATIVE OBSERVATION  
 (L) VOLTAGE-TO-FREQUENCY CONVERTER  
 (M) FREQUENCY COUNTER WITH LOW DEAD TIME  
 (N) DIGITAL RECORDER WITH FAST RECORDING SPEED  
 (INHIBIT TIME COMPATIBLE WITH COUNTER DEAD TIME)  
 (O) COMPUTER (OPTIONAL METHOD OF DATA ANALYSIS)

FIGURE 8.11. Typical time domain measurement of frequency stability (frequency sensitive mode).

data a desk calculator could be used, and the computer analysis would not be necessary. An example of a specific Allan variance computation is shown in Annex 8.E. Figure 8.12 gives a typical plot of  $\sigma$  versus  $\tau$ . The dashed lines indicate the slopes which are characteristic of the types of noise indicated.

The convenience of obtaining time domain data has been greatly enhanced by utilizing recently developed counters [33, 34] which are programmable to automatically compute  $\sigma$  versus  $\tau$ . A block diagram (fig. 8.13) shows a measurement system for determining frequency stability by using a comput-

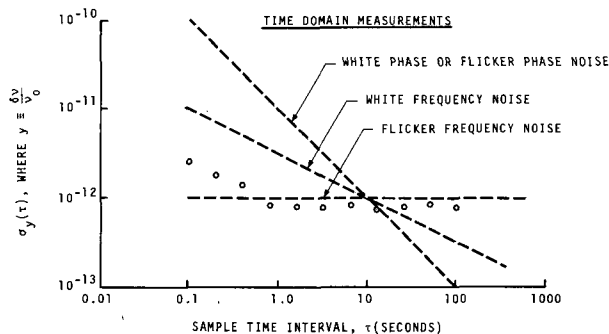

FIGURE 8.12. Sigma  $\sigma_y(\tau)$  versus tau,  $\tau$ .

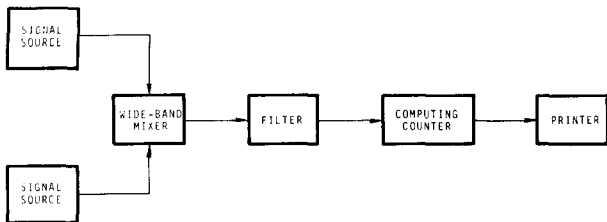
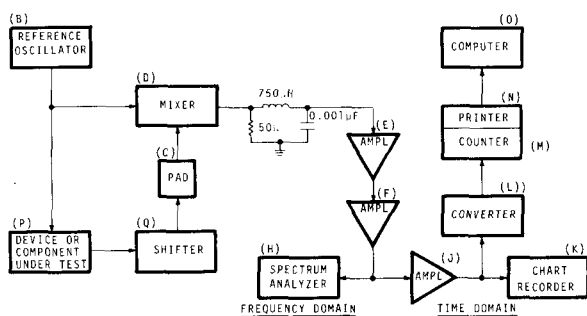

FIGURE 8.13. Frequency stability measurements using a computing counter.

ing counter programmed to estimate  $(\sigma_y^2(N=2, T, \tau, f_h))^{1/2}$ . A typical program for such use is given in Annex 8.F. Certain limitations of deadtime are inherent in the use of this time domain method. However, in general (except for very short  $\tau$ ), frequency stability in the time domain may be measured quickly and accurately using a computing counter.

### 8.14.3. Differential Phase Noise Measurements

An additional useful system, illustrated in figure 8.14, measures differential phase noise of various discrete components which are frequently found in stability measurement systems. In this system only one frequency source is used. Its output is split so that part of the signal passes through the component to be tested. The signal is adjusted via a phase shifter (fig. 8.15), so that it is in phase quadrature with the other part of the original signal and is downconverted in the Schottky barrier diode mixer as described for previous systems. The switchable  $50\Omega$  load in figure 8.15 is not essential but is included for convenience. A low-pass filter is included before the signal is amplified in special low-noise, low-level dc amplifiers and observed on the spectrum analyzer. Script  $\mathcal{L}(f)$  values are calculated at various frequency values,  $f$ , and plotted. A sample calculation is shown in Annex 8.D.



ITEMS (B) THROUGH (O) SAME AS FIGURES 8.5 AND 8.11  
(P) ANY DEVICE OR COMPONENT UPON WHICH NOISE MEASUREMENTS ARE DESIRED (AMPLIFIERS, FILTERS, CAPACITORS, CABLES, PADS, ETC.)  
(Q) NBS ADJUSTABLE PHASE SHIFTER, 5MHz (SEE FIGURE 8.15)

FIGURE 8.14. Differential phase noise measurement.

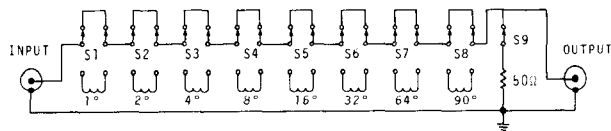

RG174/U CABLE WAS USED FOR EACH SEGMENT OF PHASE SHIFT CALCULATED AT  $\sim 10$  cm PER DEGREE AT 5 MHz.

FIGURE 8.15. Adjustable phase shifter (5-MHz delay line).

The measurement system noise level (e.g., see fig. 8.10) is easily evaluated. Using the differential phase noise measurement system shown in figure 8.14, one can use a short length of coaxial cable (which is itself not a source of significant noise) as the "device under test." The small amount of noise observed on the spectrum analyzer represents the system noise, mainly due to the mixer (O) or the first amplifier (E) in figure 8.14. The calculation of the system noise is the procedure illustrated in Annex 8.D.

## 8.15. OPERATIONAL SYSTEMS FOR MEASUREMENT OF FREQUENCY STABILITY AT NBS (MICROWAVE REGION)

The systems we have described up to this point have been used extensively for determining frequency stability of 1 to 100-MHz frequency sources. However, we anticipate that these measurement systems would provide useful data for frequency sources up to 2 GHz, using the identical system illustrated in figures 8.5 and 8.11, with some modifications for the higher frequencies. Section 8.15 describes measurement procedures for microwave frequency sources at X-band (5–12.4 GHz). For the frequency band 2 to 5 GHz we expect that either the HF or microwave (wave guide components) systems may be used; the wave guide system would be more expensive, and the HF method would require more sophisticated circuitry for good phase lock.

Thorough investigation of stability measurement techniques in the X-band region (5–12.4 GHz), revealed that it generally was desirable to use a method different from that previously described for HF measurements. The recommended measurement system for the microwave band follows; other techniques of stability measurements in X-band will be discussed to a lesser extent. The recommended system<sup>5</sup> is a single-oscillator system as shown in the photograph of figure 8.16 and in the block diagram of figure 8.17. These measurement systems are based on earlier work by Ashley et al. [38] and Ondria [39].

<sup>5</sup> The recommended system is discussed here as a frequency domain measurement. However, time domain measurements can also be made.

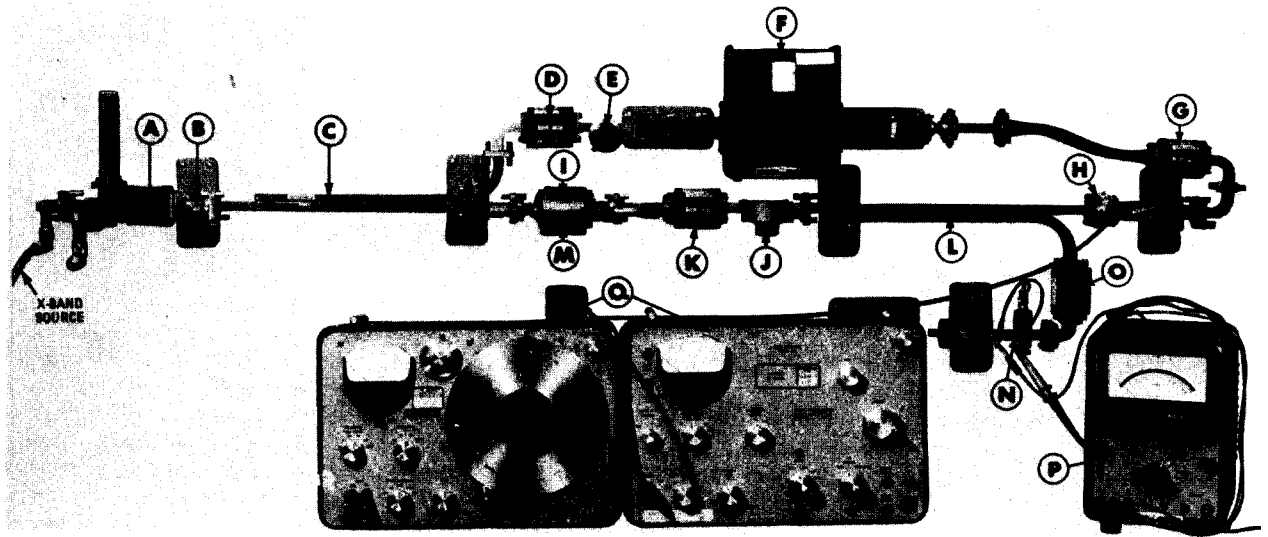

FIGURE 8.16. Single oscillator frequency stability measurement system. (Pictorial).

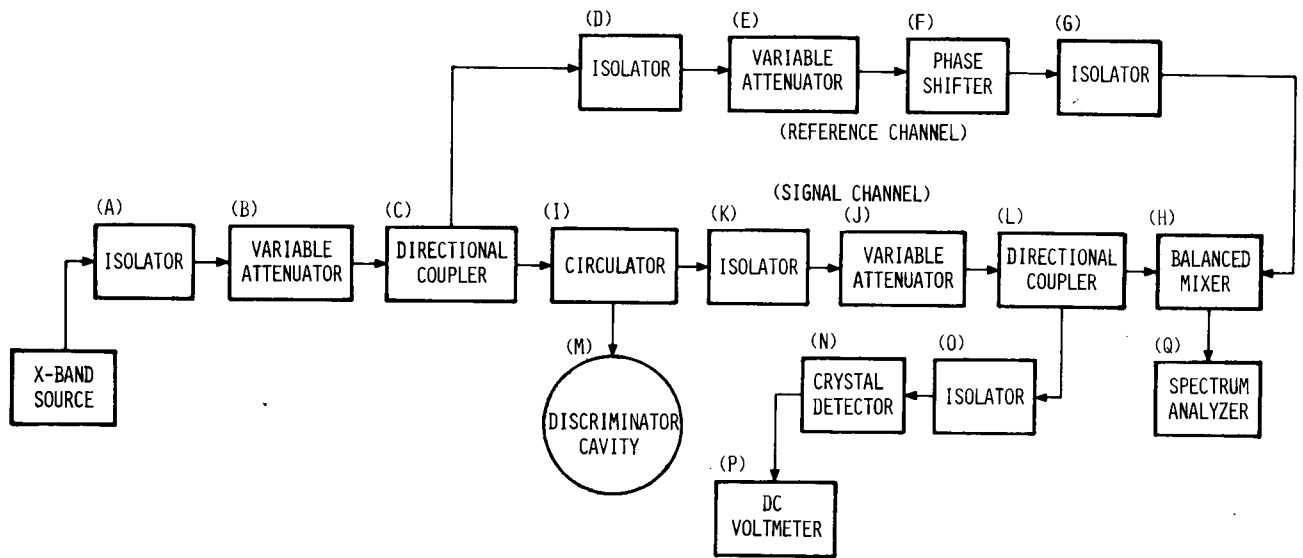

FIGURE 8.17. Single oscillator frequency stability measurement system. (Block diagram).

### 8.15.1. Basic Considerations of the Microwave (Frequency Stability) Measurement System

The single-oscillator frequency stability measurement system is basically a frequency modulation (FM) demodulator. That is, it can retrieve from the modulated carrier the signal with which the carrier was originally frequency modulated.

An important consideration when making these measurements is maintenance of the quadrature condition—a  $90^\circ$  average phase difference between the reference channel and the signal channel as seen at the mixer. Unfortunately, there is a fairly high probability that, during the course of a measurement, the average phase difference will fluctuate a few degrees about the desired  $90^\circ$  setting. Therefore, it is recommended that an occasional check of the quadrature condition be made. (In a two-oscillator system of measurement, discussed later, the quadrature condition—in long term—is established and maintained by phase-locking one source to the other. A similar procedure could be used here, but we consider it to be unnecessary in practice.)

In practice, there is a low frequency limit to the usefulness of this method for the measurement of FM noise. We have seen limiting values of  $f$  ranging from as high as 500 Hz to as low as 2.5 Hz. The single-oscillator system and the two-oscillator system each have an upper frequency limit; i.e., a value of  $f$  above which frequency stability measurements cannot meaningfully be made. For the single-oscillator system, as described here, this upper limit is  $f \approx W_c$ , where  $W_c$  is the 3-dB resonance linewidth of the loaded discriminator cavity. In the NBS single-oscillator system, measurements were made at values of  $f$  as high as 100 kHz.

### 8.15.2. Description of the Microwave (Frequency Stability) Measurement System

Operation of the single-oscillator measuring system may readily be followed by referring to the pictorial view in figure 8.16 and the block diagram, given in figure 8.17. The X-band source under test is connected at the left-hand side of the system. The signal passes through an isolator (A) and variable attenuator (B) before it is split via a 3-dB directional coupler (C). (It should be noted that isolators (A), (D), (G), (K), and (O) are used at several points throughout the system as a means of preventing any serious reflections which might otherwise exist.) The signal from output 1 of the coupler enters the reference channel (upper arm), passing through a phase shifter (F) via a variable attenuator (E) and eventually through a  $90^\circ$  twist into the balanced mixer (H). Output 2 from the coupler enters the signal channel (lower arm), passing through a three-port circulator (I) connected to a discriminator

cavity (M) at one port. A variable attenuator (J) reduces the circulator output in the signal channel before it reaches the balanced mixer (H). The output of the mixer goes to either of two spectrum analyzers (Q). A 10-dB directional coupler (L) is utilized in the signal channel to facilitate detection of resonance tuning of the cavity. This is observed via a detector (N) with a dc voltmeter readout (P).

The only component in the system, not readily available as a commercial stock item, is the discriminator cavity (M). It is a  $TE_{011}$  right circular one-port cavity. A movable end wall provides the coarse tuning. The fine tuner is a small diameter rod which can be moved coaxially in the cavity. The diameter of the rod should be such that the cavity frequency changes no more than 1.5 MHz for 0.05 inch ( $\sim 1$  millimeter) change in depth of insertion. At any desired frequency the coupling of the cavity should be such that the absorption is very nearly complete. For further discussion of cavity coupling see reference [38]. The cavity Q must be both high enough for good sensitivity and sufficiently low for the required bandwidth. The cavity used in the NBS frequency stability measurement system has an unloaded Q of approximately 20,000.

### 8.15.3. Calibration Procedure

Initial calibration of the measurement system is necessary for assignment of an absolute scale to the stability measurements. To facilitate calibration, a sinusoidally-modulated X-band source is used to drive the system. The frequency-modulated signal is observed on an RF power spectral density analyzer (not shown in figs. 8.16 and 8.17) and the modulation level is adjusted to a value sufficient to completely suppress the X-band carrier. For sinusoidal modulation, the first carrier null corresponds to a modulation index of 2.4. Modulation at 5 kHz was convenient because of the particular dispersion and bandwidth settings which were available on the particular spectrum analyzer used to display the carrier suppression. The detailed procedure for obtaining the calibration factor is given in Annex 8.H.

### 8.15.4. Measurement Procedure

The procedure for obtaining data for the spectral density plot is quite similar to the calibration procedure except that the X-band carrier is not subjected to intentional modulation. Detailed steps for X-band frequency stability measurements are given in Annex 8.I. Included are techniques for calculating values of  $S_{\delta\phi}(f)$ . Results of such calculations for an X-band Gunn diode oscillator signal source is given in figure 8.18.

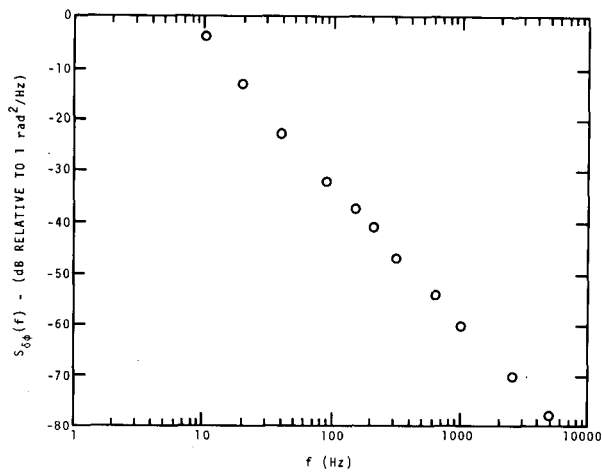

FIGURE 8.18. Frequency domain plot of phase noise of X-band Gunn diode oscillator signal source (single oscillator method).

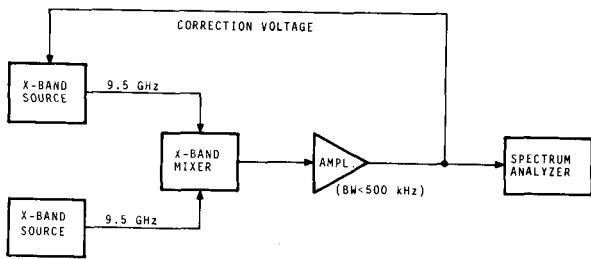

FIGURE 8.19. Frequency stability measurement system (phase-lock servo loop).

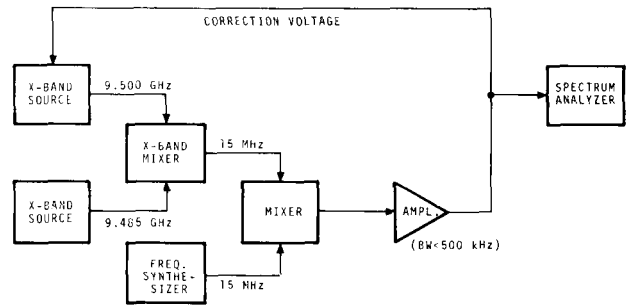

FIGURE 8.20. Frequency stability measurement system (offset-frequency phase-lock servo loop).

### 8.15.5. Additional Techniques for Frequency Stability Measurements at X-Band

It has been found convenient and desirable, under certain circumstances, to use other techniques for measuring frequency stability at X-band. Where two X-band sources are available, phase- or frequency-locking techniques similar to those used at HF can be used. (See figs. 8.19–8.21). Good wide-band double-balanced mixers with coaxial connectors are available [40] which permit many of the measurements to be performed without use of waveguide components.

The measurement setup, shown in the block diagram of figure 8.13, also can be used at microwave frequencies; this system utilizes a computing counter for time domain measurements. Extensive

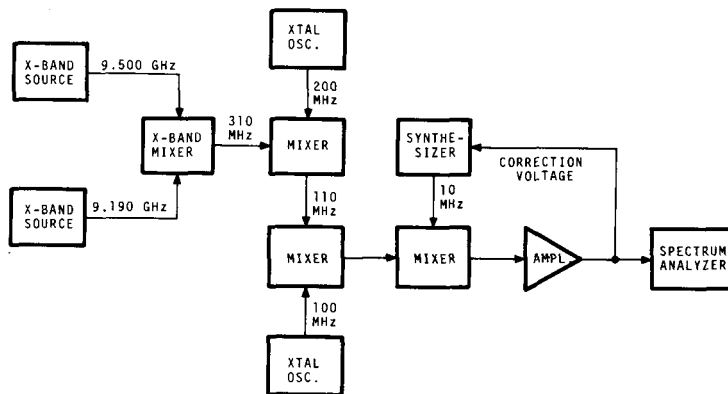

FIGURE 8.21. Frequency stability measurement system (large frequency-offset phase-lock servo loop).



measurements of frequency stability have been made on stabilized X-band sources [40]. Time domain data obtained via the computing counter have been compared with frequency domain data obtained via several methods. The example shown in Annex 8.D, the frequency domain data of figure 8.18, are translated into time domain data; these data are plotted in figure 8.22. In the same figure we have plotted time domain data taken directly via a computing counter using the system shown in figure 8.13.

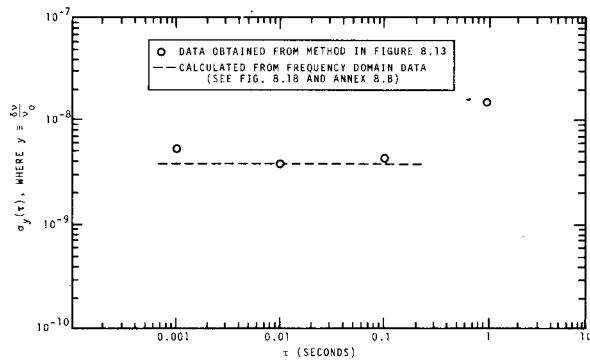

FIGURE 8.22. Time domain plot of X-band Gunn diode oscillator signal source.

## 8.16. CONCLUSIONS/SUMMARY

Concise definitions for specifying frequency stability have been given for measurements in the frequency domain and time domain. The first part of this chapter gives an in-depth characterization of frequency stability to enable understanding of the basic concepts. This is followed by a description of operational systems for measurement of frequency stability in detail sufficient for duplication of the required instrumentation. Uniform methods of reporting data and techniques of measurement both are recommended as advantageous and desirable for better interpretation of frequency stability specifications. The methods are applicable for both HF and microwave frequency sources.

## 8.17. REFERENCES

- [1] Barnes, J. A., Chi, A. R., Cutler, L. S., Healey, D. J., Leeson, D. B., McGunigal, T. E., Mullen, J. A., Jr., Smith, W. L., Sydnor, R., Vessot, R. F. C., and Winkler, G. M. R., "Characterization of frequency stability," *IEEE Trans. on Instrum. and Meas.*, **IM-20**, No. 2, pp. 105-120 (May 1971).
- [2] Shoaf, J. H., Halford, D., and Risley, A., "Frequency stability specification and measurement: high frequency and microwave signals," *Nat. Bur. Stand. (U.S.) Tech. Note 632*, 70 pages (USGPO, January 1973).
- [3] Barnes, J. A., "Tables of bias functions,  $B_1$  and  $B_2$ , for variances based on finite samples of processes with power

- law spectral densities," *Nat. Bur. Stand. (U.S.) Tech. Note 375*, 37 pages (USGPO, January 1969).
- [4] CGPM, *Comptes Rendus des Séances de la Treizième Conférence Général des Poids et Mesures*, (Proceedings of the Sessions of the 13th General Conference of Weights and Measures) (Paris, France, October 1968), p. 103 (Gauthier-Villars, Paris, France, 1968) (in French—see chap. 1—ann. 1.A.1).
- [5] CCIR, "Detailed instructions by Study Group 7 for the implementation of Recommendation 460 concerning the improved coordinated universal time (UTC) system, valid from 1 January 1972," in *XIIIth Plenary Assembly CCIR* (New Delhi, India, 1970), **III**, p. 258 a-d (ITU, Geneva, Switzerland, 1970) (see chap. 1—ann. 1.B.2).
- [6] Beehler, R. E., Mockler, R. C., and Richardson, J. M., "Cesium beam atomic time and frequency standards," *Metrologia*, **1**, No. 3, pp. 114-131 (July 1965).
- [7] Allan, D. W., Hellwig, H., Halford, D., Blair, B. E., Barnes, J. A., and Beehler, R. E., NBS/CCIR Study Group 7 Sub-committee for definition of terms (October 1971).
- [8] Allan, D. W., "Statistics of atomic frequency standards," *Proc. IEEE*, **54**, No. 2, pp. 221-230 (February 1966).
- [9] Chi, A. R. (Chairman), *IEEE-NASA Symp. on Short-Term Frequency Stability* (Goddard Space Flight Center, Greenbelt, MD 20771, November 23-24, 1964) *NASA SP-80*, 317 pages (USGPO, 1965).
- [10] Chi, A. R. (Guest Ed.) *Special Issue on Frequency Stability*, *Proc. IEEE*, **54**, No. 2, pp. 101-280 (February 1966).
- [11] Jaynes, E. T., "Information theory and statistical mechanics," *Phys. Rev.*, **108**, Sec. 15, pp. 171-190 (October 1957).
- [12] Bingham, C., Godfrey, M. D., and Tukey, J. W., "Modern techniques of power spectrum estimation," *IEEE Trans. Audio AU-15*, No. 2, pp. 56-66 (June 1967).
- [13] Blackman, R. B., *Linear data smoothing and prediction in theory and practice*, 182 pages (Addison-Wesley Publishing Co., Reading, MA 01867, 1965).
- [14] Blackman, R. B., and Tukey, J. W., *The measurement of power spectra*, 190 pages (Dover Publishing Co., New York, NY 10014, 1958).
- [15] Brigham, E. O., and Morrow, R. E., "The fast Fourier transform," *IEEE Spectrum*, **4**, No. 12, pp. 63-70 (December 1967).
- [16] Baghdady, E. J., Lincoln, R. D., and Nelin, B. D., "Short-term frequency stability: theory, measurement and status," *Proc. IEEE-NASA Symp. on Short-term Frequency Stability*, (Goddard Space Flight Center, Greenbelt, MD 20771, November 23-24, 1964), *NASA SP-80*, pp. 65-87 (USGPO, 1965); *Proc. IEEE*, **53**, No. 7, pp. 704-722 (July 1965); and *Proc. IEEE (Corresp.)*, **53**, No. 12, pp. 2110-2111 (December 1965).
- [17] Cutler, L., and Searle, C., "Some aspects of the theory and measurement of frequency fluctuations in frequency standards," *Proc. IEEE*, **54**, No. 2, pp. 136-154 (February 1966).
- [18] Shewart, N. A., *Economic control of quality of manufactured product*, p. 146 (Van Nostrand-Reinhold Co., New York, NY 10001, 1931).
- [19] Lesage, P., and Audoin, C., "Characterization of frequency stability: uncertainty due to the finite number of measurements," *IEEE Trans. on Instrum. and Meas.*, **IM-22**, No. 2, pp. 157-161 (June 1973).
- [20] Barnes, J. A., "Atomic timekeeping and the statistics of precision signal generators," *Proc. IEEE*, **54**, No. 2, pp. 207-220 (February 1966).
- [21] Barnes, J. A., and Allan, D. W., "An approach to the prediction of coordinated universal time," *Frequency*, **5**, No. 6, pp. 15-20 (November-December 1967).
- [22] Vessot, R. F. C., Peters, H., Vanier, J., Beehler, R., Halford, D., Harrach, R., Allan, D., Glaze, D., Snider, C., Barnes, J., Cutler, L., and Bodily, L., "An intercomparison of hydrogen and cesium frequency standards," *IEEE Trans. on Instrum. and Meas.*, **IM-15**, No. 4, pp. 165-176 (December 1966).

## ANNEX 8.A

### GLOSSARY OF SYMBOLS

- |  |  |
|--|--|
| <p>[23] Leeson, D. B., and Johnson, G. F., "Short-term stability for a Doppler radar: requirements, measurements, and techniques," <i>Proc. IEEE</i>, <b>54</b>, No. 2, pp. 244-248 (February 1966).</p> <p>[24] Saunders, W. K., in <i>Radar Handbook</i>, Skolnik, M. I. (Ed.), "CW and FM radar," Chap. 16, pp. 16-1-16-38 (McGraw-Hill Book Co., New York, NY 10036, 1970).</p> <p>[25] Raven, R. S., "Requirements on master oscillators for coherent radar," <i>Proc. IEEE</i>, <b>54</b>, No. 2, pp. 237-243 (February 1966).</p> <p>[26] Leeson, D. B., "A simple model of feedback oscillator noise spectrum," <i>Proc. IEEE</i>, <b>54</b>, No. 2, pp. 329-330 (February 1966).</p> <p>[27] Vessot, R. F. C., Mueller, L., and Vanier, J., "The specification of oscillator characteristics from measurements made in the frequency domain," <i>Proc. IEEE</i>, <b>54</b>, No. 2, pp. 199-207 (February 1966).</p> <p>[28] Gardner, F. M., <i>Phase-lock techniques</i>, 182 pages (John Wiley &amp; Sons, New York, NY 10016, 1966).</p> <p>[29] Menoud, C., Racine, J., and Kartaschoff, P., "Atomic hydrogen maser work at L.S.R.H., Neuchatel, Switzerland," <i>Proc. 21st Ann. Symp. on Frequency Control</i>, (U.S. Army Electronics Command, Ft. Monmouth, NJ 07703, April 24-26, 1967) pp. 543-567 (NTIS, AD 659792, April 1967).</p> <p>[30] Mungall, A. G., Morris, D., Daams, H., and Bailey, R., "Atomic hydrogen maser development at the National Research Council of Canada," <i>Metrologia</i>, <b>4</b>, No. 3, pp. 87-94 (July 1968).</p> <p>[31] Vessot, R. F. C., "Atomic hydrogen masers, an introduction and progress report," <i>Hewlett-Packard J.</i>, <b>20</b>, pp. 15-20 (Hewlett-Packard, Palo Alto, CA 94304, October 1968).</p> <p>[32] Halford, D., Shoaf, J. H., and Risley, A. S., "Spectral density analysis: frequency domain specification and measurement of signal stability," <i>Proc. 27th Ann. Symp. on Frequency Control</i> (U.S. Army Electronics Command, Ft. Monmouth, NJ 07703, June 12-14, 1973), pp. 421-431 (Electron. Ind. Assn., Washington, DC 20006, 1973).</p> <p>[33] Hewlett-Packard staff, "Precision frequency measurements," <i>Application Note 116</i>, 12 pages (Hewlett-Packard, Palo Alto, CA 94304, July 1969).</p> <p>[34] Hewlett-Packard staff, <i>Computer Counter Applications Library</i>, No. 6—"Fractional frequency deviation-short term stability of oscillators;" No. 22—"The frequency difference of two frequency standards;" No. 27—"Fractional frequency deviation measurements on ultrastable sources;" and No. 29—"Frequency stability measurements of crystals in the presence of significant frequency drift," (Hewlett-Packard, Palo Alto, CA 94304, 1970).</p> <p>[35] Van Duzer, V., "Short-term stability measurements," <i>Proc. of IEEE-NASA Symp. on the Definition and Measurement of Short-Term Frequency Stability</i> (Goddard Space Flight Center, Greenbelt, MD 20771, November 23-24, 1964), <i>NASA SP-80</i>, pp. 269-272 (USGPO, 1965).</p> <p>[36] Meyer, D. G., "A test set for measurement of phase noise on high quality signal sources," <i>IEEE Trans. on Instrum. and Meas.</i>, <b>IM-19</b>, No. 4, pp. 215-227 (November 1970).</p> <p>[37] Shields, R. B., "Review of the specification and measurement of short-term stability," <i>Microwave J.</i>, <b>12</b>, No. 6, pp. 49-55 (June 1969).</p> <p>[38] Ashley, J. R., Searles, C. B., and Palka, F. M., "The measurement of oscillator noise at microwave frequencies," <i>IEEE Trans. on Microwave Theory and Techniques</i>, <b>MTT-16</b>, No. 9, pp. 753-760 (September 1968).</p> <p>[39] Ondria, J., "A microwave system for measurements of AM and FM noise spectra," <i>IEEE Trans. on Microwave Theory and Techniques</i>, <b>MTT-16</b>, No. 9, pp. 767-781 (September 1968).</p> <p>[40] Reeve, G. R., Signal detection systems, Unpublished report (October 1967).</p> <p>[41] Risley, A. S., Shoaf, J. H., and Ashley, J. R., "Frequency stabilization of X-band sources for use in frequency synthesis into the infrared," <i>IEEE Trans. on Instrum. and Meas.</i>, <b>IM-23</b>, No. 2 (June 1974).</p> | <p><math>A_{pp}</math> Peak-to-peak voltage of a beat frequency at output of mixer.</p> <p><math>B</math> High frequency cutoff <math>f_h</math> (bandwidth).</p> <p><math>B_a</math> Analysis bandwidth (frequency window) of the spectrum analyzer.</p> <p><math>B_1(N, r, \mu);</math><br/><math>B_2(r, \mu)</math> Bias functions for variances based on finite samples of a process with a power-law spectral density (see ref. [3]).</p> <p><math>C_a</math> A real constant defined in reference [1].</p> <p><math>c_0, c_1</math> Real constants.</p> <p><math>c(t)</math> A real, deterministic function of time.</p> <p><math>D_x^2(\tau)</math> Expected value of the squared second difference of <math>x(t)</math> with lag time <math>\tau</math>. (see ref. [1]).</p> <p><math>f \equiv \omega/2\pi</math> Fourier frequency of fluctuations.</p> <p><math>f_h</math> High-frequency cutoff of an idealized infinitely sharp cutoff, low-pass filter (see symbol <math>B</math>).</p> <p><math>f_l</math> Low-frequency cutoff of an idealized infinitely sharp cutoff, high-pass filter.</p> <p><math>g(t)</math> A real function of time.</p> <p><math>h_a</math> Positive real coefficient of <math>f^a</math> in a power series expansion of the spectral density of the function <math>y(t)</math>.</p> <p><math>i, j, k, m, n</math> Integers, often a dummy index of summation.</p> <p><math>K</math> Calibration factor used in the single oscillator stability measurement system for microwave frequencies, <math>K = (\Delta\nu)_{\text{rms}}/V_{\text{rms}}</math>.</p> <p><math>\mathcal{L}(f)</math> Frequency domain measure of phase fluctuation sidebands; Script <math>\mathcal{L}(f)</math> is defined as the ratio of</p> <p style="text-align: center;">Power density (one phase modulation sideband)<br/>-----<br/>Power (total signal)</p> <p>For small <math>\delta\phi</math>, <math>S_{\delta\phi}(f) = 2\mathcal{L}(f)</math>.</p> <p><math>M</math> Total number of data values available (usually <math>M \gg N</math>).</p> |
|--|--|

	Also, positive integer giving the number of cycles averaged.	$V_0$	Nominal peak amplitude of signal generator output; see eq (8.4).
$N$	Positive integer giving the number of data values used in obtaining a sample variance.	$V_{0r}$	Peak amplitude of reference signal; see eq (8.42).
$n(t)$	A nondeterministic function of time.	$V_{r(t)}$	Instantaneous voltage of reference signal; see eq (8.42).
$P_{\text{total}}$	Total power of signal.	$V_{\text{rms}}$	Root-mean-square voltage of the output of an FM demodulator due to intentional modulation.
$R_y(\tau)$	Autocovariance function of $y(t)$ (see ref. [1]).	$v$	Root-mean-square (noise) voltage at output of mixer as measured by a spectrum analyzer.
$r$	Parameter related to dead time ( $T - \tau$ ); $r \equiv T/\tau$ .	$v(t)$	Voltage output of ideal product detector.
$S_{\delta v}(f)$	Spectral density of frequency fluctuations.	$v'(t)$	Low-pass filtered output of product detector.
$S_{\delta V}(f)$	Spectral density of voltage fluctuations.	$W_c$	The $-3$ dB resonance linewidth of the loaded discriminator cavity.
$S_{\delta\phi}(f)$	Spectral density of phase fluctuations:	$x(t)$	Real function of time related to the phase of the signal $V(t)$ by the eq $x(t) \equiv [\varphi(t)]/(2\pi\nu_0)$ .
	$S_{\delta\phi}(f) = \frac{S_{\delta v}(f)}{f^2} = S_y(f) \frac{\nu_0^2}{f^2}.$	$\hat{x}(t)$	A predicted value for $x(t)$ .
$S_{\sqrt{\text{RFP}}}(\nu)$	Spectral density of the (square root of the) radio frequency power.	$x$	Time interval fluctuations; $\frac{dx}{dt} \equiv y$ , hence $x = \delta\tau$ .
$S_y(f)$	One-sided (power) spectral density on a per hertz basis of the pure real function $g(t)$ . The dimensions of $S_y(f)$ are the dimensions of $g^2(t)/f$ .	$y$	Fractional frequency fluctuations, $y \equiv \frac{\delta\nu}{\nu_0}$ .
$S_y(f)$	A definition for the measure of frequency stability. One-sided (power) spectral density of $y(t)$ on a per hertz basis. The dimensions of $S_y(f)$ are $\text{Hz}^{-1}$ (spectral density of fractional frequency fluctuations).	$\bar{y}$	Average of $y$ over a specified time interval, $\tau$ .
$T$	Time interval between the beginnings of two successive measurements.	$y(t)$	Fractional frequency offset of $V(t)$ from the nominal frequency; see eq (8.9).
$t$	Time variable.	$\bar{y}_k$	Average fractional frequency offset during the $k$ th measurement interval; see eq (8.11).
$t_0$	An arbitrary fixed instant of time.	$\langle \bar{y} \rangle_N$	The sample average of $N$ successive values of $\bar{y}_k$ ; see reference [1].
$t_k$	The time coordinate of the beginning of the $k$ th measurement of average frequency. By definition $t_{k+1} = t_k + T$ , $k = 0, 1, 2, \dots$	$z_n(t)$	Nondeterministic (noise) function with (power) spectral density; see eq (8.28).
$u$	Dummy variable of integration; $u \equiv \pi f \tau$ .	$\langle \rangle$	Infinite time average operator.
$V(t)$	Instantaneous output voltage of signal generator; see eq (8.4).	$\alpha$	Exponent of $f$ for a power-law spectral density.
		$\gamma$	Positive real constant.
		$\Delta$	Difference operator.
		$\delta$	Fluctuation operator.
		$\delta\nu$	Frequency fluctuations.
		$\delta\phi$	Phase fluctuations and is equivalent to $\phi(t)$ .

$\delta_k(r-1)$ The Kronecker  $\delta$  function defined by

$$\delta_k(r-1) \equiv \begin{cases} 1, & \text{if } r=1 \\ 0, & \text{otherwise.} \end{cases}$$

 $\delta V, v$   
 $\epsilon(t)$ Voltage fluctuations.  
Amplitude fluctuations of signal; see eq (8.4). $\mu$ Exponent of  $\tau$ ; see eq (8.32). $v$ 

Signal frequency (carrier frequency) variable.

 $\nu(t)$ Instantaneous frequency of  $V(t)$ .  
Defined by

$$\nu(t) \equiv \frac{1}{2\pi} \frac{d}{dt} \Phi(t).$$

 $\nu_0$ Nominal (constant) frequency of  $V(t)$ . $\kappa(f)$ The Fourier transform of  $n(t)$ .  
Square root of a variance. $\sigma$  $\sigma_y^2(N, T, \tau, f_h)$ Sample variance of  $N$  averages of  $y(t)$ , each of duration  $\tau$ , and repeated every  $T$  units of time measured in a post-detection noise bandwidth of  $f_h$ ; see eq (8.59). $\langle \sigma_y^2(N, T, \tau, f_h) \rangle$ Average value of the sample variance  $\sigma_y^2(N, T, \tau, f_h)$ ; (Allan variance). $\sigma_y^2(\tau)$ Specific Allan variance where  $N=2$ ,  $T=\tau$ ; see eq (8.60); Allan variances. $\tau$ 

Sampling time interval; see eq (8.11).

 $\tau_a$ 

Post-detection averaging time of the spectrum analyzer.

 $\Phi(t)$ Instantaneous phase of  $V(t)$ .  
Defined by  $\Phi(t) \equiv 2\pi\nu_0 t + \varphi(t)$ . $\varphi(t)$ Instantaneous phase fluctuations about the ideal phase  $2\pi\nu_0 t$ ; see eq (8.4) and is equivalent to  $\delta\phi$ . $\psi_x^2(T, \tau)$ 

Mean-square time error for Doppler radar; see reference [1].

 $\Omega$ Signal angular frequency (carrier angular frequency),  $\Omega \equiv 2\pi\nu$ . $\omega$ Fourier angular frequency of fluctuations,  $\omega \equiv 2\pi f$ .**ANNEX 8.B****TRANSLATION OF DATA FROM FREQUENCY DOMAIN TO TIME DOMAIN USING THE CONVERSION CHART (table 8.1)**

Referring to the frequency domain plot in figure 8.18 it is determined that  $S_{\delta\phi}(f)$  indicates  $f^{-3}$  behavior over the total range plotted. Therefore  $S_{\delta\nu}(f)$  is proportional to  $f^{-1}$  (i.e., flicker frequency noise). At  $f=1000$  Hz,  $S_{\delta\nu}(f)$  is equal to  $-0.3$  dB relative to 1 Hz (see table 8.2). The carrier frequency,  $\nu_0$ , is 9.5 GHz.

$$S_y(f) = \frac{S_{\delta\nu}(f)}{\nu_0^2} = \frac{(10^{-0.03}\text{Hz})}{(9.5 \times 10^9\text{Hz})^2} = 1.04 \times 10^{-20}\text{Hz}^{-1} \quad (8.B.1)$$

$$S_y(f) = \frac{h_{-1}}{f} \quad (8.B.2)$$

(see conversion chart-table 8.1).

$$h_{-1} = S_y(f) \times f = (1.04 \times 10^{-20}\text{Hz}^{-1}) \times (10^3\text{Hz}) = 10.4 \times 10^{-18} \quad (8.B.3)$$

$$\sigma_y^2(\tau) = h_{-1} \cdot 2 \ln 2 = 10.4 \times 10^{-18} \times 1.39 = 14.5 \times 10^{-18} \quad (8.B.4)$$

$$\sigma_y(\tau) = 3.8 \times 10^{-9} \quad (8.B.5)$$

For flicker frequency noise there is no  $\tau$  dependence. A dashed line at this calculated value is plotted on the same graph as data taken directly in the time domain (fig. 8.22).

**ANNEX 8.C****SPECTRAL DENSITIES: FREQUENCY DOMAIN MEASURES OF STABILITY**

Stability in the frequency domain is commonly specified in terms of spectral densities. We have used the concept of spectral density extensively in this chapter. The spectral density concept is simple and very useful, but care must be exercised in its use. There are at least four different, but related, types of spectral densities which are used in this chapter. In this Annex, we state and explain some of the simple, often-needed relations among these often-used types of spectral densities.

### 8.C.1. Some Types of Spectral Densities

Four types of spectral densities which are most relevant to frequency and phase fluctuations are

- $S_y(f)$  Spectral density of fractional frequency fluctuations,  $y$  (noise, instability, modulation). The dimensionality is per hertz. The range of  $f$  is from zero to infinity.
- $S_{\delta\nu}(f)$  Spectral density of frequency fluctuations  $\delta\nu$  (noise, instability, modulation). The dimensionality is hertz squared per hertz. The range of  $f$  is from zero to infinity.
- $S_{\delta\phi}(f)$  Spectral density of phase fluctuations  $\delta\phi$  (noise, instability, modulation). The dimensionality is radians squared per hertz. The range of  $f$  is from zero to infinity.
- $\mathcal{L}(f)$  Script  $\mathcal{L}(f)$  is a frequency domain measure of phase fluctuation sidebands (noise, instability, modulation). Script  $\mathcal{L}(f)$  is defined as the ratio of the power in one phase modulation sideband, referred to the input carrier frequency, on a spectral density basis, to the total signal power, at Fourier frequency  $f$  from the signal's average frequency  $\nu_0$ , for a single specified signal or device. The dimensionality is per hertz. The range of  $f$  is from minus  $\nu_0$  to plus infinity.

Each of these spectral densities is one-sided and is on a per hertz of bandwidth density basis. This means that the total mean-square fluctuation (the total variance) of frequency, for example, is given mathematically by

$$\int_0^{\infty} S_{\delta\nu}(f) df,$$

and, as another example, since Script  $\mathcal{L}(f)$  is a normalized density, that

$$\int_{-\nu_0}^{+\infty} \mathcal{L}(f) df$$

is equal to unity.

Two-sided spectral densities are defined such that the range of integration is from minus infinity to plus infinity. For specification of noise as treated in this chapter, our one-sided spectral density is twice as large as the corresponding two-sided spectral density. That is,

$$\begin{aligned} \int_{-\infty}^{+\infty} [S^{\text{Two-Sided}}] df &= 2 \int_0^{+\infty} [S^{\text{Two-Sided}}] df \\ &= \int_0^{+\infty} [S^{\text{One-Sided}}] df. \end{aligned} \quad (8.C.1)$$

Two-sided spectral densities are useful mainly in pure mathematical analysis involving Fourier transformations. We recommend and use one-sided spectral densities for experimental work.

We use the definition

$$y \equiv \frac{\delta\nu}{\nu_0}, \quad (8.C.2)$$

and it follows that

$$S_y(f) \equiv S_{\frac{\delta\nu}{\nu_0}}(f) = \left(\frac{1}{\nu_0}\right)^2 S_{\delta\nu}(f). \quad (8.C.3)$$

To relate frequency, angular frequency, and phase we use

$$2\pi[\nu(t)] = \Omega(t) = \frac{d\Phi(t)}{dt}. \quad (8.C.4)$$

This may be regarded as a definition of instantaneous frequency  $\nu(t)$ . From eq (8.C. 4), a direct result of transform theory is

$$S_{\delta\phi}(f) = \left(\frac{1}{\omega}\right)^2 S_{\delta\Omega}(f) = \left(\frac{1}{f}\right)^2 S_{\delta\nu}(f). \quad (8.C.5)$$

Script  $\mathcal{L}(f)$  can be related in a simple way to  $S_{\delta\phi}(f)$ , but only for the condition that the phase fluctuations occurring at rates  $f$  and faster are small compared to one radian. Otherwise Bessel function algebra must be used to relate Script  $\mathcal{L}(f)$  to  $S_{\delta\phi}(f)$ . Fortunately, the "small angle condition" is often met in random noise problems. Specifically we find

$$\mathcal{L}(f) \approx \left(\frac{1}{2 \text{ rad}^2}\right) S_{\delta\phi}(f), \quad (8.C.6)$$

provided that

$$\int_f^{+\infty} S_{\delta\phi}(f') df' \ll 1 \text{ rad}^2. \quad (8.C.7)$$

For the types of signals under discussion and for  $|f| < \nu_0$ , we use as a good approximation

$$\mathcal{L}(-f) \approx \mathcal{L}(f). \quad (8.C.8)$$

Script  $\mathcal{L}(f)$  is the normalized version of the phase modulation (PM) portion of  $S_{\sqrt{\text{RFP}}}(\nu)$ , with its frequency parameter  $f$  referenced to the signal's average frequency  $\nu_0$  as the origin such that  $f$  equals  $\nu - \nu_0$ . In the absence of amplitude modulation (AM), all of the radio frequency power (RFP) in the sidebands is associated with phase modulation. In high quality signal sources, it is often found that the AM is negligible compared to the PM.

### 8.C.2. Some Mathematics of Phase Sideband Power as Related to Phase Fluctuations

A simple derivation of eq (8.C.6) is possible. We combine the derivation with an example which illustrates the operation of a double-balanced mixer as a phase detector. Consider two sinusoidal 5-MHz signals (having negligible amplitude modulation) feeding the two input ports of a double-balanced mixer. When the two signals are slightly out of zero beat, a slow sinusoidal beat with a period of several seconds at the output of the mixer is measured to have a peak-to-peak swing of  $A_{ptp}$ .

Without changing their amplitudes, the two signals are retuned to be at zero beat and in phase quadrature (that is,  $\pi/2$  out of phase with each other), and the output of the mixer is a small fluctuating voltage centered on zero volts. Provided this fluctuating voltage is small compared to  $A_{ptp}/2$ , the phase quadrature condition is being closely maintained, and the "small angle condition" is being met. Further details on this measurement procedure are given in Section 8.14.1 and figure 8.5.

Phase fluctuations  $\delta\phi$  between the two signals of phases  $\phi_2$  and  $\phi_1$ , respectively, where

$$\delta\phi \equiv \delta(\phi_2 - \phi_1), \quad (8.C.9)$$

will give rise to voltage fluctuations  $\delta V$  at the output of the mixer

$$\delta V \approx \frac{A_{ptp}}{2} \delta\phi, \quad (8.C.10)$$

where we have used radian measure for phase angles, and we have used

$$\sin \delta\phi \approx \delta\phi, \quad (8.C.11)$$

for small  $\delta\phi$  ( $\delta\phi \ll 1$  rad). We solve eq (8.C.10) for  $\delta\phi$ , square both sides, and take a time average

$$\langle (\delta\phi)^2 \rangle \approx 4 \frac{\langle (\delta V)^2 \rangle}{(A_{ptp})^2}. \quad (8.C.12)$$

If we interpret the mean-square fluctuations of  $\delta\phi$  and of  $\delta V$ , respectively, in eq (8.C.12) in a spectral density fashion, we may write

$$S_{\delta\phi}(f) \approx \frac{S_{\delta V}(f)}{2(A_{rms})^2}, \quad (8.C.13)$$

where we have used

$$(A_{ptp})^2 = 8(A_{rms})^2, \quad (8.C.14)$$

which is valid for the sinusoidal beat signal.

For the types of signals under consideration, by definition the two phase noise sidebands (lower sideband and upper sideband, at  $-f$  and  $+f$  from  $\nu_0$ , respectively) of a signal are coherent with each other. As already expressed in eq (8.C.8), they are of equal intensity also. The operation of the mixer, when it is driven at quadrature, is such that the amplitudes of the two phase sidebands add linearly in the output of the mixer, resulting in four times as much power in the output as would be present if only one of the phase sidebands were allowed to contribute to the output of the mixer. Hence for  $|f| < \nu_0$  we obtain

$$\frac{S_{\delta V}(|f|)}{(A_{rms})^2} \approx 4 \frac{[S_{\sqrt{\text{RFP}}}(\nu_0 + f)]}{P_{\text{total}}} \text{PM}, \quad (8.C.15)$$

and, using the definition of Script  $\mathcal{L}(f)$ ,

$$\mathcal{L}(f) \equiv \frac{[S_{\sqrt{\text{RFP}}}(\nu_0 + f)]}{P_{\text{total}}} \text{PM} \approx \frac{1}{2} S_{\delta\phi}(|f|), \quad (8.C.16)$$

provided the phase quadrature condition is approximately valid. Recall that we assumed the signals have negligible amplitude modulation. The phase quadrature condition will be met for a time interval at least  $\tau$  long, provided

$$\int_{(2\pi\tau)^{-1}}^{\infty} S_{\delta\phi}(f') df' \ll 1 \text{ rad}^2, \quad (8.C.17)$$

and hence eq (8.C.16) is useful for values of  $f$  at least as low as  $(2\pi\tau)^{-1}$ . Equations (8.C.16) and (8.C.17) correspond to eq (8.C.6) and (8.C.7), respectively.

## ANNEX 8.D

### A SAMPLE CALCULATION OF SCRIPT $\mathcal{L}$

For convenience of computation and plotting it often is advantageous to set the beat frequency voltage (before locking) to  $\frac{1}{\sqrt{10}}$  volts (0.316 V) peak-to-peak at the mixer output. Then (after lock) with the output of the phase detector expressed in rms nanovolts per root hertz, direct plotting is facilitated for Script  $\mathcal{L}(f)$  in decibels versus frequency in hertz. In this case 1000, 100, and 10 nanovolts per root hertz correspond to  $-110$ ,  $-130$ , and  $-150$  dB respectively. A sample calculation demonstrating this convenience is shown below. Equation (8.D.3) given for Script  $\mathcal{L}(f)$  is valid for the case where two equally noisy signals are driving the mixer.

Given:

$$A_{\mu\nu} = 0.316 V \left( \text{i.e., } \frac{1}{\sqrt{10}} V \right), \quad (8.D.1)$$

$$v = 100 \text{ nV Hz}^{-1/2} @ f = 20 \text{ Hz}, \quad (8.D.2)$$

from a pair of equally noisy signals.

$$\mathcal{L}(20 \text{ Hz}) = \left( \frac{v}{A_{\mu\nu}} \right)^2 \quad (8.D.3)$$

$$\begin{aligned} &= \left( \frac{100 \text{ nV Hz}^{-1/2}}{0.316 \text{ V}} \right)^2 = \left( \frac{10^{-7}}{\sqrt{10^{-1}}} \right) \text{ Hz}^{-1} = \frac{10^{-14}}{10^{-1}} \text{ Hz}^{-1} \\ &= 10^{-13} \text{ Hz}^{-1} = -130 \text{ dB}, \end{aligned}$$

or using logarithms:

$$\begin{aligned} \mathcal{L}(20 \text{ Hz}) &= 20 \log_{10} \left( \frac{v}{A_{\mu\nu}} \right) \quad (8.D.4) \\ &= 20 \log_{10} \frac{(10^{-7} \text{ V} \cdot \text{Hz}^{-1/2})}{(10^{-1/2} \text{ V})} = 20(-7 + 0.5) \\ &= -130 \text{ dB}. \end{aligned}$$

If the phase noise follows flicker law, at  $f = 1 \text{ Hz}$  it is 20 times worse (or 13 dB greater); that is

$$\mathcal{L}(1 \text{ Hz}) = -130 \text{ dB} + 13 \text{ dB} = -117 \text{ dB}. \quad (8.D.5)$$

## ANNEX 8.E

### A SAMPLE CALCULATION OF ALLAN VARIANCE, $\sigma_y^2(\tau)$

$$\begin{aligned} \sigma_y^2(\tau) &\equiv \langle \sigma_y^2(N=2, T=\tau, \tau) \rangle = \left\langle \frac{(\bar{y}_{k+1} - \bar{y}_k)^2}{2} \right\rangle \\ &\approx \frac{1}{2(M-1)} \sum_{k=1}^{M-1} (\bar{y}_{k+1} - \bar{y}_k)^2. \quad (8.E.1) \end{aligned}$$

in the example below:

Number of data values available,  $M = 9$   
 Number of differences averaged,  $M - 1 = 8$   
 Sampling time interval  $\tau = 1 \text{ s}$

TABLE 8.E.1. Sample data tabulation

Data values ( $\bar{y}$ )	First differences ( $\bar{y}_{k+1} - \bar{y}_k$ )	First differences squared ( $\bar{y}_{k+1} - \bar{y}_k$ ) <sup>2</sup>
892	—	—
809	-83	6889
823	14	196
798	-25	625
671	-127	16129
644	-27	729
883	239	57121
903	20	400
677	-226	51076
	$\sum_{k=1}^{M-1} (\bar{y}_{k+1} - \bar{y}_k)^2 = 133165$	

Based on these data:

$$\sigma_y^2(\tau) = \frac{133165}{2(8)} = 8322.81, \quad (8.E.2)$$

$$[\sigma_y^2(\tau)]^{1/2} = \sqrt{8322.81} = 91.23, \quad N = 2, T = \tau = 1 \text{ s}. \quad (8.E.3)$$

In this example, the data values may be understood to be expressed in parts in  $10^{12}$ ; the data may have been taken as the counted number of periods, in the time interval  $\tau$ , of the beat frequency between the oscillator under test and a reference oscillator, divided by the nominal carrier frequency  $\nu_0$ , and multiplied by the factor  $10^{12}$ .

Using the same data as in the above example it is possible to calculate the Allan variance for  $\tau = 2 \text{ s}$  by averaging pairs of adjacent data values and using these averaged values as new data values to proceed with the calculation as before. Allan variance values may be obtained for  $\tau = 3 \text{ s}$  by averaging three adjacent data values in a similar manner, etc., for larger values of  $\tau$ .

Ideally the calculation is done via a computer and a large number,  $M$ , of data values should be used. (Typically  $M = 256$  data values are used in the NBS computer program.) The statistical confidence of the calculated Allan variance improves nomially as the square root of the number,  $M$ , of data values used [19]. For  $M = 256$ , the confidence of the Allan variance is expected to be approximately  $\pm \frac{1}{\sqrt{256}} \times 100 \text{ percent} \approx \pm 7 \text{ percent}$  of its value. The use of  $M \gg 1$  is logically similar to the use of  $B_u \cdot \tau_u \gg 1$  in spectrum analysis measurements, where  $B_u$  is the analysis bandwidth (frequency window) of the spectrum analyzer, and  $\tau_u$  is the post-detection averaging time of the spectrum analyzer.

**COMPUTING COUNTER PROGRAM  
USING AN EFFICIENT OVER-  
LAPPING ESTIMATOR FOR  
 $\langle \sigma_y^2(N=2, T, \tau, f_h) \rangle^{1/2}$**

- |  |                             |
|--|-----------------------------|
| (1) MANUAL   | (19) REPEAT                 |
| (2) Enter carrier or<br>basic frequency                                    | (20) X FER PROGRAM          |
| (3) $c \overrightarrow{x}$<br>[skip to (33) if pro-<br>gram is already in] | (21) $\overrightarrow{Nxy}$ |
| (4) LEARN  | (22) $\overrightarrow{Nxy}$ |
| (5) CLEAR x  | (23) + (add)                |
| (6) $b \overrightarrow{x}$   | (24) $a \overrightarrow{x}$ |
| (7) MODULE or<br>PLUG-IN   | (25) $\overrightarrow{bxy}$ |
| (8) $a \overrightarrow{x}$   | (26) $\overrightarrow{axy}$ |
| (9) X FER PROGRAM  | (27) $\div$ (divide)        |
| (10) MODULE or<br>PLUG-IN  | (28) 1                      |
| (11) $a \overrightarrow{x}$  | (29) $\sqrt{x}$             |
| (12) $\overrightarrow{axy}$  | (30) $\overrightarrow{cxy}$ |
| (13) - (subtract)  | (31) $\div$ (divide)        |
| (14) $\overrightarrow{xy}$   | (32) PAUSE                  |
| (15) $\times$ (multiply)   | (33) RUN                    |
| (16) $\overrightarrow{bxy}$  | (34) START                  |
| (17) + (add)   | Program will automat-       |
| (18) $b \overrightarrow{x}$  | ically repeat unless right  |

$\tau \equiv$  Sample time (computing counter "measurement time").

$T - \tau \approx 0.003$  seconds (compute + cycle time)

$N = 2$

$f_h \equiv$  Measurement system bandwidth

Number set on repeat loop corresponds to the number of estimates of the variance. For good confidence levels 100 or more estimates usually are required.

**SELECTED FREQUENCY STABIL-  
ITY REFERENCES: BIBLIOG-  
RAPHY<sup>6</sup>**

- 8.G.1. Selected References (Proceedings, Special Issues, etc.) Applicable to Measurement and Specification of Frequency Stability.
- 8.G.2. Bibliography of Time and Frequency Stability References.

**ANNEX 8.G.1**

**Selected References (Proceedings, Special Issues, etc.) Applicable to Measurement and Specification of Frequency Stability**

- [R1]<sup>7</sup> *IEEE Trans. on Instrum. and Meas.* (Principle proceedings of the International Conference on Precision Electromagnetic Measurements (CPEM), held every two years) (November or December of even-numbered years).
- [R2] *Proc. IEEE, Special Issue on Frequency Stability* (IEEE-NASA Symp.) **54**, No. 2 (February 1966).
- [R3] IEEE-NASA, *Proc. of the IEEE-NASA Symp. on the Definition and measurement of Short-Term Frequency Stability* (Goddard Space Flight Center, Greenbelt, MD 20771, November 23-24, 1964) *NASA-SP-80*, 317 pages (USGPO, 1965).
- [R4] Barnes, J. A., Chi, A. R., Cutler, L. S., Healey, D. J., Leeson, D. B., McGunigal, T. E., Mullen, J. A., Jr., Smith, W. L., Sydnor, R., Vessot, R. F. C., and Winkler, G. M. R., "Characterization of Frequency Stability," *Nat. Bur. Stand. (U.S.) Tech. Note 394*, 50 pages (USGPO, October 1970); also published in *IEEE Trans. on Instrum. and Meas.*, **IM-20**, No. 2, pp. 105-120 (May 1971). This is the most definitive discussion to date of the characterization and measurement of frequency stability. It was prepared by the Subcommittee on Frequency Stability of the Institute of Electrical and Electronic Engineers.
- [R5] *IEEE Trans. on Microwave Theory and Techniques, Special Issue on Noise, MTT-16*, No. 9 (September 1968).
- [R6] *Proc. IEEE, Special Issue on Time and Frequency*, **60**, No. 5, (May 1972).

<sup>6</sup> Annotated when additional information is pertinent.

<sup>7</sup> R denotes reference listing.



[R7] U.S. Army Electronics Command, *Proc. Ann. Symp. on Frequency Control* (U.S. Army Electronics Command, Ft. Monmouth, NJ 07703). These symposia are held usually at Atlantic City during the spring of each year. The Proceedings contain a wide variety of frequency/time papers, including general interest, progress reports, and well-documented state-of-the-art accounts. Information about the Proceedings for the last years is given on page 178, together with the source of availability.

tant reprints of NBS papers written during 1960 to 1970 (February) on various time and frequency subjects including statistics of frequency and time measurements.

[R9] Blair, B. E., "Time and frequency: A bibliography of NBS literature published July 1955-December 1970." *Nat. Bur. Stand. (U.S.), Spec. Publ. 350*, 52 pages (U.S. GPO, June 1971). This publication is a rather complete bibliography (for the time period noted) on many aspects of time and frequency as studied by NBS.

Symposium Number	Date	Proceedings Accession No.	Pages	Availability	Cost
10*	May 15-17, 1956.....	AD 298322	585	National Technical Information Service, Sills Building, 5285 Port Royal Road, Springfield, VA 22151.	\$3.00
11	May 7-9, 1957.....	AD 298323	634	NTIS.....	3.00
12	May 6-8, 1958.....	AD 298324	666	NTIS.....	3.00
13	May 12-14, 1959.....	AD 298325	723	NTIS.....	3.00
14	May 31-June 2, 1960.....	AD 246500	443	NTIS.....	3.00
15	May 31-June 2, 1961.....	AD 265455	335	NTIS.....	3.00
16	April 25-27, 1962.....	AD 285086	455	NTIS.....	3.00
17	May 27-29, 1963.....	AD 423381	618	NTIS.....	3.00
18	May 4-6, 1964.....	AD 450341	597	NTIS.....	3.00
19	April 20-22, 1965.....	AD 471229	673	NTIS.....	3.00
20	April 19-21, 1966.....	AD 800523	679	NTIS.....	3.00
21	April 24-26, 1967.....	AD 659792	579	NTIS.....	3.00
22	April 22-24, 1968.....	AD 844911	620	NTIS.....	3.00
23	May 6-8, 1969.....	AD 746209	313	NTIS.....	3.00
24	April 27-30, 1970.....		361	Electronics Industries Assn., 2001 Eye Street, NW, Washington, DC 20006.	6.50
25	April 26-28, 1971.....	AD 746211	351	NTIS.....	3.00
26	June 6-8, 1972.....		322	Electronics Industries Assn.....	6.50
27	June 12-14, 1973.....		446	Electronics Industries Assn.....	6.50

\*First published proceedings.

[R8] Blair, B. E., and Morgan, A. H. (Eds.), *Precision Measurement and Calibration-Selected NBS Papers on Frequency and Time*, *Nat. Bur. Stand. (U.S.) Spec. Publ. 300*, V, 555 pages (USGPO, June 1972). This volume contains impor-

[R10] Shoaf, J. H., Halford, D., and Risley, A., "Frequency stability specification and measurement: high frequency and microwave signals," *Nat. Bur. Stand. (U.S.) Tech. Note 632*, 70 pages (USGPO, January 1973).

## ANNEX 8.G.2

### Bibliography of Time and Frequency Stability References

- [B1]<sup>a</sup> Allan, D. W., "Statistics of atomic frequency standards," *Proc. IEEE*, **54**, No. 2, pp. 221-230 (February 1966). A thorough understanding of this paper is important for everyone who wishes to measure and quote performance of frequency standards in the time domain, e.g.,  $\sigma$  versus  $\tau$  plots. The data analysis must take into account the number of samples taken and how they are used.
- [B2] Allan, D. W., Blair, B. E., Davis, D. D., and Machlan, H. E., "Precision and accuracy of remote synchronization via portable clocks, Loran C, and network television broadcasts," *Proc. 25th Ann. Symp. on Frequency Control* (U.S. Army Electronics Command, Ft. Monmouth, NJ 07703, April 26-28, 1971) pp. 195-208 (NTIS, AD 746211, 1971); also published in *Metrologia*, **8**, No. 2, pp. 64-72 (April 1972).
- [B3] Allan, D. W., Gray, J. E., and Machlan, H. E., "The National Bureau of Standards atomic time scales: generation, dissemination, stability, and accuracy," *IEEE Trans. on Instrum. and Meas.*, **IM-21**, No. 4, pp. 388-391 (November 1972). (See Chap. 9).
- [B4] Allan, D. W., Machlan, H. E., and Marshall, J., "Time transfer using nearly simultaneous reception times of a common transmission," *Proc. 26th Ann. Symp. on Frequency Control* (U.S. Army Electronics Command, Ft. Monmouth, NJ 07703, June 6-8, 1972) pp. 309-316 (Electron. Ind. Assn., Washington, DC 20006, 1972).
- [B5] Anderson, A. E., and Brower, H. P., "A tunable phase detector for short-term frequency measurement," *Proc. IEEE-NASA Symp. on the Definition and Measurement of Short-Term Frequency Stability* (Goddard Space Flight Center, Greenbelt, MD 20771, November 23-24, 1964), *NASA SP-80*, pp. 295-302 (USGPO, 1965).
- [B6] Ashley, J. R., and Searles, C. B., "Microwave oscillator noise reduction by a transmission stabilizing cavity," *IEEE Trans. on Microwave Theory and Techniques*, **MTT-16**, No. 9, pp. 743-748 (September 1968).
- [B7] Ashley, J. R., Searles, C. B., and Palka, F. M., "The measurement of oscillator noise at microwave frequencies," *IEEE Trans. on Microwave Theory and Techniques*, **MTT-16**, No. 9, pp. 753-760 (September 1968).
- [B8] Atkinson, W., and Fey, L., "Statistical aspects of clock errors," Unpublished report (January 1960).
- [B9] Atkinson, W. R., Fey, L., and Newman, J., "Spectrum analysis of extremely low frequency variations of quartz oscillators," *Proc. IEEE (Corresp.)*, **51**, No. 2, p. 379 (February 1963).
- [B10] Baghdady, E. J., Lincoln, R. D., and Nelin, B. D., "Short-term frequency stability: theory, measurement, and status," *Proc. IEEE-NASA Symp. on the Definition and Measurement of Short-Term Frequency Stability* (Goddard Space Flight Center, Greenbelt, MD 20771, November 23-24, 1964), *NASA SP-80*, pp. 65-87 (USGPO, 1965); also *Proc. IEEE*, **53**, No. 7, pp. 704-722 (July 1965); and *Proc. IEEE (Corresp.)*, **53**, No. 12, pp. 2110-2111 (December 1965). Among many other topics, the possible problem of AM noise is discussed.
- [B11] Bagnall, J. J., Jr., "The effect of noise on an oscillator controlled by a primary reference," *NEREM 1959 Record*, pp. 84-85 (March 1961).
- [B12] Barber, R. E., "Short-term frequency stability of precision oscillators and frequency generators," *Bell Sys. Tech. J.*, **50**, No. 3, pp. 881-915 (March 1971).
- [B13] Barnes, J. A., "Studies of frequency stability," Unpublished report (August 1969).
- [B14] Barnes, J. A., "Frequency measurement errors of passive resonators caused by frequency-modulated exciting signals," *IEEE Trans. on Instrum. and Meas.*, **IM-19**, No. 3, pp. 147-152 (August 1970).
- [B15] Barnes, J. A., "Atomic timekeeping and the statistics of precision signal generators," *Proc. IEEE*, **54**, No. 2, pp. 207-220 (February 1966).
- [B16] Barnes, J. A., "Tables of bias functions,  $B_1$  and  $B_2$ , for variances based on finite samples of processes with power law spectral densities," *Nat. Bur. Stand. (U.S.) Tech. Note 375*, 37 pages (USGPO, January 1969).
- [B17] Barnes, J. A., and Allan, D. W., "A statistical model of flicker noise," *Proc. IEEE*, **54**, No. 2, pp. 176-178 (February 1966).
- [B18] Barnes, J. A., and Allan, D. W., "Effects of long-term stability on the definition and measurement of short-term stability," *Proc. IEEE-NASA Symp. on the Definition and Measurement of Short-Term Frequency Stability*, (Goddard Space Flight Center, Greenbelt, MD 20771, November 23-24, 1964), *NASA SP-80*, pp. 119-123 (USGPO, 1965).
- [B19] Barnes, J. A. et al. (see ref. [R4]).
- [B20] Barnes, J. A., and Heim, L. E., "A high-resolution ammonia maser spectrum analyzer," *IRE Trans. on Instrum.*, **I-10**, No. 1, pp. 4-8 (June 1961).
- [B21] Barnes, J. A., and Mockler, R. C., "The power spectrum and its importance in precise frequency measurements," *IRE Trans. on Instrum.*, **I-9**, No. 2, pp. 149-155 (September 1960).
- [B22] Baugh, R. A., "Frequency modulation analysis with the Hadamard variance," *Proc. 25th Ann. Symp. on Frequency Control* (U.S. Army Electronics Command, Ft. Monmouth, NJ 07703, April 26-28, 1971), pp. 222-225 (NTIS, AD 746221, 1971).
- [B23] Baugh, R. A., "Low noise frequency multiplication," *Proc. 26th Ann. Symp. on Frequency Control* (U.S. Army Electronics Command, Ft. Monmouth, NJ 07703, June 6-8, 1972), pp. 50-54 (Electron. Ind. Assn., Washington, DC 20006, 1972).
- [B24] Becker, G., "Mathematische Filterung von Meßwerten; Anwendungen im Bereich von Zeit und Frequenz" (Mathematical filtering of measuring values; applications in the scope of time and frequency), *PTB Mitt.*, **79**, No. 4, pp. 247-252 (August 1969).
- [B25] Bendat, J. S., *Principles and Applications of Random Noise Theory*, 431 pages (John Wiley and Sons, New York, NY 10016, 1958).
- [B26] Bennett, W. R., *Electrical Noise*, 280 pages (McGraw-Hill Book Co., New York, NY 10036, 1960).
- [B27] Bennett, W. R., "Methods of solving noise problems," *Proc. IRE*, **44**, No. 5, pp. 609-638 (eq 223 ff.) (May 1956).
- [B28] Bernstein, I., and Gorelik, G., "Frequency modulation noise in oscillators," *Proc. IRE (Corresp.)*, **45**, No. 1, p. 94 (January 1957).
- [B29] Bingham, C., Godfrey, M. D., and Tukey, J. W., "Modern techniques of power spectrum estimation," *IEEE Trans. Audio*, **AU-15**, No. 2, pp. 56-66 (June 1967).
- [B30] Blackman, R. B., and Tukey, J. W., *The Measurement of Power Spectra*, 190 pages (Dover Publishing Co., New York, NY 10014, 1958).
- [B31] Brandenberger, H., Hadorn, F., Halford, D., and Shoaf, J. H., "High quality quartz crystal oscillators: frequency domain and time domain stability," *Proc. 25th Ann. Symp. on Frequency Control* (U.S. Army Electronics Command, Ft. Monmouth, NJ 07703, April 26-28, 1971), pp. 226-230 (NTIS, AD 746211, 1971). An example of 1970 "state-of-the-art" measurements.
- [B32] Brigham, E. O., and Morrow, R. E., "The fast Fourier transform," *IEEE Spectrum*, **4**, No. 12, pp. 63-70 (December 1967).

<sup>a</sup> B denotes bibliographic listing.

- [B33] Buck, J. R., and Healey, D. J., III, "Calibration of short-term frequency stability measuring apparatus," *Proc. IEEE (Lett.)*, **54**, No. 2, p. 305 (February 1966).
- [B34] Buck, J. R., and Healey, D. J., III, "Short term frequency stability measurement of the crystal controlled x-band source," *Proc. IEEE-NASA Symp. on the Definition and Measurement of Short Term Frequency Stability*, (Goddard Space Flight Center, Greenbelt, MD 20771, November 23-24, 1964), *NASA SP-80*, pp. 201-209 (USGPO, 1965).
- [B35] Buck, J. R., Healey, D. J., III, and Meiseles, M., "Measurement of phase stability of quartz crystal oscillators for airborne radar applications," *IEEE Intern. Conv. Rec.*, pt. 8, pp. 34-42 (March 1964).
- [B36] Campbell, G. A., and Foster, R. M., *Fourier Integrals for Practical Applications*, 177 pages (D. Van Nostrand Reinhold Co., New York, NY 10001, 1948).
- [B37] Campbell, R. A., "Stability measurement techniques in the frequency domain," *Proc. IEEE-NASA Symp. on the Definition and Measurement of Short-Term Frequency Stability* (Goddard Space Flight Center, Greenbelt, MD 20771, November 23-24, 1964), *NASA SP-80*, pp. 231-235 (USGPO, 1965).
- [B38] Chenette, E. R., "Low noise transistor amplifiers," *Solid State Design*, **5**, pp. 27-30 (February 1964).
- [B39] Chramiec, J., "Noise properties of a superregenerative parametric amplifier," *Proc. IEEE*, **54**, No. 4, p. 704 (April 1966).
- [B40] Crow, E. L., "The statistical construction of a single standard from several available standards," *IEEE Trans. on Instrum. and Meas.*, **IM-13**, No. 4, pp. 180-185 (December 1964).
- [B41] Cutler, L. S., "Some aspects of the theory and measurement of frequency fluctuations in frequency standards," *Proc. IEEE-NASA Symp. on the Definition and Measurement of Short-Term Frequency Stability* (Goddard Space Flight Center, Greenbelt, MD 20771, November 23-24, 1964), *NASA SP-80*, pp. 89-100 (USGPO, 1965).
- [B42] Cutler, L. S., "Present status in short-term frequency stability," *Frequency*, **5**, No. 5, pp. 13-15 (September-October 1967). This is a well-written, concise progress report with indications for future effort. Caution: His examples I and II were not in fact state-of-the-art, while example IV shows some typographical errors.
- [B43] Cutler, L. S., and Searle, C. L., "Some aspects of the theory and measurement of frequency fluctuations in frequency standards," *Proc. IEEE*, **54**, No. 2, pp. 136-154 (February 1966). This is a useful treatment of some theory, mathematics, and measurement techniques—with physical insight into the noise processes of practical concern.
- [B44] Davenport, W. B., and Root, W. L., *An Introduction to the Theory of Random Signals and Noise*, "Spectral Analysis" Chap. 6, pp. 87-111 (McGraw-Hill Book Co., New York, NY 10036, 1958).
- [B45] DePrins, J., and Cornelissen, G., "Analyse spectrale discrète" (Discrete spectral analysis) (EUROCON '71, IEEE Region 8 Convention, Lausanne, Switzerland, October 1971), *Bull. de l'Académie Royale de Belgique (Classe des Sciences)* **57**, Série 5°, pp. 1243-1266 (Palais des Académies, Bruxelles, Belgium, December 1971).
- [B46] DePrins, J., Descornet, G., Gorski, M., and Tamine, J., "Frequency-domain interpretation of oscillator phase stability," *IEEE Trans. on Instrum. and Meas.*, **IM-18**, No. 4, pp. 251-261 (December 1969).
- [B47] Driscoll, M. M., "Two-stage self-limiting series mode type quartz crystal oscillator exhibiting improved short-term frequency stability," *Proc. 26th Ann. Symp. on Frequency Control* (U.S. Army Electronics Command, Ft. Monmouth, NJ 07703, June 6-8, 1972), pp. 43-49 (Electron. Ind. Assn., Washington, DC 20006, 1972).
- [B48] Dvornikov, É. V., Mavrin, É. A., and Morkovin, N. V., "A high-stability transistorized crystal oscillator," *Prilozheniya i Tekhn. Eksperim. (USSR)*, No. 4 (July-August 1963). For English translation see *Instr. Exper. Tech.*, No. 4, pp. 672-674 (Instr. Soc. Amer., Pittsburgh, PA 15222, February 1964).
- [B49] Edson, W. A., "Noise in oscillators," *Proc. IRE*, **48**, No. 8, pp. 1454-1466 (August 1969). Note: This paper is an old "classic."
- [B50] Edson, W. A., "Progress and problems in short term stability," *Proc. 19th Ann. Symp. on Frequency Control* (U.S. Army Electronics Command, Ft. Monmouth, NJ 07703, April 20-25, 1965), pp. 43-48 (NTIS, AD 471229, 1965).
- [B51] Esposito, R., and Mullen, J. A., "Noise in oscillators with general tank circuits," *IRE Intern. Conf. Rec.*, pt. 4, pp. 202-208 (March 1961).
- [B52] Finnie, C., Sydnor, R., and Sward, A., "Hydrogen maser frequency standard," *Proc. 25th Ann. Symp. on Frequency Control* (U.S. Army Electronics Command, Ft. Monmouth, NJ 07703, April 26-28, 1971), pp. 348-351 (NTIS, AD 746211, 1971).
- [B53] Fey, L., Atkinson, W. R., and Newman, J., "Obscurities of oscillator noise," *Proc. IEEE (Corresp.)*, **52**, No. 1, pp. 104-105 (January 1964).
- [B54] Gerber, E. A., and Sykes, R. A., "State of the art—quartz crystal units and oscillators," *Proc. IEEE*, **54**, No. 2, pp. 103-116 (February 1966) (see chaps 2A and 2B).
- [B55] Gerber, E. A., and Sykes, R. A., "Quartz frequency standards," *Proc. IEEE*, **55**, No. 6, pp. 783-791 (June 1967).
- [B56] Glaze, D. J., "Improvements in atomic beam frequency standards at the National Bureau of Standards," *IEEE Trans. on Instrum. and Meas.*, **IM-19**, No. 3, pp. 156-160 (August 1970) (see chap. 5A).
- [B57] Golay, M. J. E., "Monochromaticity and noise in a regenerative electrical oscillator," *Proc. IRE*, **48**, No. 8, pp. 1473-1477 (August 1960).
- [B58] Grauling, C. H., Jr., and Healey, D. J., III, "Instrumentation for measurement of the short-term frequency stability of microwave sources," *Proc. IEEE*, **54**, No. 2, pp. 249-257 (February 1966).
- [B59] Gray, R. M., and Tausworthe, R. C., "Frequency-counted measurements and phase locking to noisy oscillators," *IEEE Trans. on Comm. Tech.*, **COM-19**, No. 1, pp. 21-30 (February 1971).
- [B60] Grivet, P., and Blaquièrre, A., "Nonlinear effects of noise in electronic clocks," *Proc. IEEE*, **51**, No. 11, pp. 1606-1614 (November 1963).
- [B61] Gros Lambert, J., Olivier, M., and Uebersfeld, J., "Automatic plotting systems for frequency stability curves and discrete spectral density of frequency standards," *IEEE Trans. on Instrum. and Meas.*, **IM-21**, No. 4, pp. 405-408 (November 1972).
- [B62] Hadad, J. D., "Basic relation between the frequency stability specification and the application," *Proc. IEEE-NASA Symp. on the Definition and Measurement of Short-Term Frequency Stability* (Goddard Space Flight Center, Greenbelt, MD 20771, November 23-24, 1964), *NASA SP-80*, pp. 11-18 (USGPO, 1965).
- [B63] Hafner, E., "The effects of noise on crystal oscillators," *Proc. IEEE*, **54**, No. 2, pp. 179-198 (February 1966).
- [B64] Halford, D., "A general mechanical model for  $|f|^{\alpha}$  spectral density random noise with special reference to flicker noise  $1/|f|$ ," *Proc. IEEE*, **56**, No. 3, pp. 251-258 (March 1968).
- [B65] Halford, D., Wainwright, A. E., and Barnes, J. A., "Flicker noise of phase in rf amplifiers and frequency multipliers: characterization, cause, and cure," (Summary), *Proc. 22nd Ann. Symp. on Frequency Control* (U.S. Army Electronics Command, Ft. Monmouth, NJ 07703, April 22-44, 1968), pp. 340-341 (NTIS, AD 844911, 1968).

- [B66] Halford, D., Shoaf, J. H., and Risley, A. S., "Spectral density analysis: frequency domain specification and measurement of signal stability," *Proc. 27th Ann. Symp. on Frequency Control* (U.S. Army Electronics Command, Ft. Monmouth, NJ 07703, June 12-14, 1973), pp. 421-431 (Electron. Ind. Assn., Washington, DC 20006, 1973).
- [B67] Healey, D. J., III, "Flicker of frequency and phase and white frequency and phase fluctuations in frequency sources," *Proc. 26th Ann. Symp. on Frequency Control* (U.S. Army Electronics Command, Ft. Monmouth, NJ 07703, June 6-8, 1972), pp. 43-49 (Electron. Ind. Assn., Washington, DC 20006, 1972).
- [B68] Hellwig, H., "Frequency standards and clocks: a tutorial introduction," *Nat. Bur. Stand. (U.S.) Tech. Note 616*, 69 pages (USGPO, April 1972).
- [B69] Hewlett-Packard Staff, *Frequency and Time Standards*, Application Note 52, 91 pages (Hewlett-Packard, Palo Alto, CA 94304, 1965).
- [B70] Hewlett-Packard Staff, *Precision Frequency Measurements*, Applications Note 116, 12 pages (Hewlett-Packard, Palo Alto, CA 94304, 1969).
- [B71] Hewlett-Packard Staff, *Computing Counter Applications Library*, Nos. 7, 22, 27, 29 (Hewlett-Packard, Palo Alto, CA 94304, 1970).
- [B72] Holman, R. H., and Paciorek, L. J., "Short-term stability measurement techniques and results," *Proc. IEEE-NASA Symp. on the Definition and Measurement of Short-Term Frequency Stability* (Goddard Space Flight Center, Greenbelt, MD 20771, November 23-24, 1964), *NASA SP-80*, pp. 237-252 (USGPO, 1965).
- [B73] Johnson, S. L., Smith, B. H., and Calder, D. A., "Noise spectrum characteristics of low-noise microwave tubes and solid-state devices," *Proc. IEEE*, **54**, No. 2, pp. 258-265 (February 1966).
- [B74] Kartaschoff, P., "Shot-effect influence on the frequency of an oscillator locked to an atomic beam resonator," *Proc. IEEE-NASA Symp. on the Definition and Measurement of Short-Term Frequency Stability* (Goddard Space Flight Center, Greenbelt, MD 20771, November 23-24, 1964), *NASA SP-80*, pp. 303-308 (USGPO, 1965).
- [B75] Kartaschoff, P., and Barnes, J. A., "Standard time and frequency generation," *Proc. IEEE*, **60**, No. 5, pp. 493-501 (May 1972).
- [B76] Lacey, R. F., Helgesson, A. L., and Holloway, J. H., "Short-term stability of passive atomic frequency standards," *Proc. IEEE*, **54**, No. 2, pp. 170-176 (February 1966).
- [B77] Larson, R. W., "Power spectrum of oscillator and frequency multiplier phase jitter," *Proc. IEEE (Lett.)*, **54**, No. 5, pp. 796-799 (May 1966).
- [B78] Leeson, D. B., "A simple model of feedback oscillator noise spectrum," *Proc. IEEE (Lett.)*, **54**, No. 2, pp. 329-330 (February 1966).
- [B79] Leeson, D. B., and Johnson, G. F., "Short-term stability for a Doppler radar: requirements, measurements, and techniques," *Proc. IEEE*, **54**, No. 2, pp. 244-248 (February 1966).
- [B80] Lerner, R. M., "The effect of noise on the frequency stability of a linear oscillator," *Proc. Natl. Electr. Conf.* (Chicago, IL, October 22-24, 1951), **7**, pp. 275-286 (February 1952).
- [B81] Lesage, P., and Audoin, C., "Characterization of frequency stability: Uncertainty due to the finite number of measurements," *IEEE Trans. on Instrum. and Meas.*, **IM-22**, No. 2, pp. 157-161 (June 1973).
- [B82] Malakhov, A. N., "Spectral-correlational analysis of signals with non-integrable spectra," *Izvestiya VUZ. Radiofizika*, **9**, No. 3, pp. 595-607 (1966) (English translation) *Soviet Radiophysics*, **9**, No. 3, pp. 360-366 (Consultants Bureau, New York, NY 10011, May-June 1966).
- [B83] Malakhov, A. N., "Fluctuations in a quartz oscillator," *Izvestiya VUZ. Radiofizika*, **9**, No. 3, pp. 622-624 (1966) (English translation) *Soviet Radiophysics*, **9**, No. 3, pp. 376-377 (Consultants Bureau, New York, NY 10011, May-June 1966).
- [B84] Malakhov, A. N., "Shape and width of the spectral line of oscillations in the presence of nonstationary frequency fluctuations," *Izvestiya VUZ. Radiofizika*, **9**, No. 3, pp. 625-627 (1966) (English translation) *Soviet Radiophysics*, **9**, No. 3, pp. 378-379 (Consultants Bureau, New York, NY 10011, May-June 1966).
- [B85] Malakhov, A. N., and Solin, N. N., "Fluctuations in a quartz oscillator," *Izvestiya VUZ. Radiofizika*, **12**, No. 4, pp. 529-537 (April 1969) (English translation) *Radiophysics and Quantum Electronics*, **12**, No. 4, pp. 419-425 (Consultants Bureau, New York, NY 10011, April 1969).
- [B86] Malling, L., "Phase-stable oscillators for space communications, including the relationship between the phase noise, the spectrum, the short-term stability, and the Q of the oscillator," *Proc. IRE*, **50**, No. 7, pp. 1656-1664 (July 1962).
- [B87] Mandelbrot, B., "Some noises with 1/f spectrum, a bridge between direct current and white noise," *IEEE Trans. on Inform. Theory*, **IT-13**, No. 2, pp. 289-298 (April 1967).
- [B88] McDade, J. C., "Measurement of additive phase noise contributed by the step-recovery diode in a frequency multiplier," *Proc. IEEE (Lett.)*, **54**, No. 2, pp. 292-294 (February 1966).
- [B89] Meyer, D. G., "A test set for measurement of phase noise on high quality signal sources," *IEEE Trans. on Instrum. and Meas.*, **IM-19**, No. 4, pp. 215-227 (November 1970).
- [B90] Morgan, A. H., and Barnes, J. A., "Short-time stability of a quartz-crystal oscillator as measured with an ammonia maser," *Proc. IRE (Corresp.)*, **47**, No. 10, p. 1972 (October 1959).
- [B91] Mullen, J. A., "Background noise in nonlinear oscillators," *Proc. IRE*, **48**, No. 8, pp. 1467-1473 (August 1960).
- [B92] Mullen, J. A., "Background noise in oscillators with rf pushing," *J. Electron. and Control*, **10**, pp. 127-138 (February 1961).
- [B93] Okoshi, T., Hashiguchi, S., and Kotani, M., "A new method of measuring microwave oscillator noises (long-line method)," *Electron. and Commun. in Japan*, **53-B**, No. 8, pp. 80-85 (August 1970).
- [B94] Ondria, J. G., "A microwave system for measurements of AM and FM noise spectra," *IEEE Trans. on Microwave Theory and Techniques*, **MTT-16**, No. 9, pp. 767-781 (September 1968).
- [B95] Paradysz, R. E., and Smith, W. L., "Measurement of FM noise spectra of low-noise VHF crystal controlled oscillators," *IEEE Trans. on Instrum. and Meas.*, **IM-15**, No. 4, pp. 202-211 (December 1966).
- [B96] Peterson, M. E., "The design and performance of an ultra low-noise digital frequency synthesizer for use in VLF receivers," *Proc. 26th Ann. Symp. on Frequency Control*, (U.S. Army Electronics Command, Ft. Monmouth, NJ 07703, June 6-8, 1972), pp. 55-70 (Electron. Ind. Assn., Washington, DC 20006, 1972).
- [B97] Prabhu, V., "Noise performance of abrupt-junction varactor frequency multipliers," *Proc. IEEE (Lett.)*, **54**, No. 2, pp. 285-287 (February 1966).
- [B98] Rarity, J., Saporta, L., and Weizz, G., "Study of short term stability of crystal oscillators," *Tech. Rep. Cont. DA36-039-SE-87450*, (DA 87450), Rep. No. 5, 33 pages (New York University, New York, NY 10003, July 1-September 30, 1961).
- [B99] Reeve, G. R., "Signal detection systems," unpublished report (Sponsored by Army/Navy/Air Force, JTCG-METCAL/CCG on Cont. 69-25b, October 1967).

- [B100] Rihaczek, A. W., "Signal energy distribution in time and frequency," *IEEE Trans. on Inform. Theory*, **IT-11**, No. 3, pp. 369-374 (May 1968).
- [B101] Rutman, J., "Comment on: 'Characterization of frequency stability'," *IEEE Trans. on Instrum. and Meas.*, **IM-21**, No. 1, p. 85 (February 1972).
- [B102] Rutman, J., "Bruit dans les oscillateurs-application à la métrologie des fréquences et à la spectroscopie hertzienne" (Noise in oscillators; applications to metrology of frequencies and Hertzian spectroscopy), *Thèse de Doctorat d'Etat*, Paris, France (March 1972).
- [B103] Rutman, J., "Instabilité de fréquence des oscillateurs" (Frequency instability of oscillators), *L'Onde Electrique*, **52**, No. 11, pp. 480-487 (December 1972).
- [B104] Sann, K. H., "The measurement of near-carrier noise in microwave amplifiers," *IEEE Trans. on Microwave Theory and Techniques*, **MTT-16**, No. 9, pp. 761-766 (September 1968).
- [B105] Saunders, W. K., "Short term frequency stability in coherent radar applications," *Proc. 26th Ann. Symp. on Frequency Control* (U.S. Army Electronics Command, Ft. Monmouth, NJ 07703, June 6-8, 1972), pp. 21-28 (Electron. Ind. Assn., Washington, DC 20006, 1972).
- [B106] Searle, C. L., Posner, R. D., Badesa, R. S., and Bates, V. J., "Computer-aided calculation of frequency," *Proc. IEEE-NASA Symp. on the Definition and Measurement of Short-Term Frequency Stability* (Goddard Space Flight Center, Greenbelt, MD 20771, November 23-24, 1964), *NASA SP-80*, pp. 273-277 (USGPO, 1965).
- [B107] Shields, R. B., "Review of the specification and measurement of short-term stability," *Microwave J.*, **12**, No. 6, pp. 49-55 (June 1969).
- [B108] Shoaf, J. H., Halford, D., and Risley, A., "Frequency stability specification and measurement: high frequency and microwave signals," *Nat. Bur. Stand. (U.S.) Tech. Note 632*, 70 pages (USGPO, January 1973).
- [B109] Smith, W. L., and Spencer, W. J., "Quartz crystal controlled oscillators," *Bell Tele. Lab., Final Report*, Cont. DA 36-039 sc-85373, Dept. of the Army, Proj. 3G-26-05-001-01 (March 15, 1963).
- [B110] Spencer, W. J., and Smith, W. L., "Precision crystal frequency standards," *Proc. 15th Ann. Symp. on Frequency Control* (U.S. Army Signal Res. and Develop. Lab., Ft. Monmouth, NJ 07703, May 31-June 2, 1961), pp. 139-155 (NTIS, AD 265 455, 1961).
- [B111] Stein, S. R., and Turneaure, J. P., "A superconducting-cavity-stabilised oscillator of high stability," *Electron. Lett.*, **8**, No. 13, pp. 321-323 (June 1972).
- [B112] Stewart, J. L., "Frequency modulation noise in oscillators," *Proc. IRE*, **44**, No. 3, pp. 372-376 (March 1956).
- [B113] Stover, H. L., "Theoretical explanation for the output spectra of unlocked driven oscillators," *Proc. IEEE (Lett.)*, **54**, No. 2, pp. 310-311 (February 1966).
- [B114] Stratemeyer, H. P., "The stability of standard-frequency oscillators," *General Radio Experimenter*, **38**, No. 6, pp. 1-16 (June 1964).
- [B115] Sydnor, R., Caldwell, J. J., and Rose, B. E., "Frequency stability requirements for space communications and tracking systems," *Proc. IEEE*, **54**, No. 2, pp. 231-236 (February 1966).
- [B116] Sykes, R. A., Smith, W. L., and Spencer, W. J., "Performance of precision quartz-crystal controlled frequency generators," *IRE Trans. on Instrum.*, **I-11**, No. 3 and 4, pp. 243-247 (December 1962).
- [B117] Tausworthe, R. C., "Convergence of oscillator spectral estimators for counted-frequency measurements," *IEEE Trans. on Comm. (Concise Paper)*, **COM-20**, No. 2, pp. 214-217 (April 1972).
- [B118] Troitskii, V. S., "Certain problems of the theory of fluctuations in oscillators. The influence of flicker noise," *Izv. Vysshikh Uchebn. Zavedenii, Radio-Fizika*, **1**, No. 1, pp. 20-33, (February 1958) (in Russian; English translation available from DOC library, Boulder, CO).
- [B119] Tykulsy, A., "Spectral measurements of oscillators," *Proc. IEEE (Lett.)*, **54**, No. 2, p. 306 (February 1966).
- [B120] Van Duzer, V., "Short-term stability measurements," *Proc. IEEE-NASA Symp. on the Definition and Measurement of Short-Term Frequency Stability* (Goddard Space Flight Center, Greenbelt, MD 20771, November 23-24, 1964), *NASA SP-80*, pp. 269-272 (USGPO, 1965).
- [B121] Vessot, R. F. C., Mueller, L. F., and Vanier, J., "A cross-correlation technique for measuring the short-term properties of stable oscillators," *Proc. IEEE-NASA Symp. on the Definition and Measurement of Short-Term Frequency Stability* (Goddard Space Flight Center, Greenbelt, MD 20771, November 23-24, 1964), *NASA SP-80*, pp. 111-118 (USGPO, 1965).
- [B122] Vessot, R. F. C., Mueller, L., and Vanier, J., "The specification of oscillator characteristics from measurements made in the frequency domain," *Proc. IEEE*, **54**, No. 2, pp. 199-207 (February 1966).
- [B123] Whitwell, A. L., and Williams, N., "A new microwave technique for determining noise spectra at frequencies close to the carrier," *Microwave J.*, **2**, No. 11, pp. 27-32 (November 1959).
- [B124] Zakharov, Yu. S., "Power spectrum analyzer with zero counter for weak periodic signals masked by noise," *Izvestiya VUZ. Radiofizika*, **12**, No. 4, pp. 538-542 (April 1969) (English translation) *Radiophysics and Quantum Electronics*, **12**, No. 4, pp. 426-429 (Consultants Bureau, New York, NY 10011, April 1969).

## ANNEX 8.H

### DETAILED PROCEDURE FOR CALIBRATING MICROWAVE (FREQUENCY-STABILITY) MEASUREMENT SYSTEM

The reader is referred to figure 8.17 in following the step-wise calibration procedure below. Note that a *sinusoidally-modulated* X-band frequency source is used to drive the system to facilitate the calibration. (For a general overview of the method see sec. 8.15.3.)

(a) With the discriminator cavity (M) far off resonance, set the level of the X-band signal (as determined with a dc voltmeter (P) at the detector (N)) to a convenient value and *record* the value. The first variable attenuator (B) should be used for this adjustment. Any convenient level may be chosen provided an equal amount of power also will be available from the signal source which is to be evaluated.

(b) Attenuate the intentional modulation so that no sidebands are visible on the power spectral density analyzer (see sec. 8.15.3).

(c) Adjust the cavity to resonance. The dc voltmeter at the detector is used to determine resonance. Place the dc voltmeter at the output of the mixer (H) and adjust the phase shifter (F) in the reference channel until the dc output at the mixer is zero (phase quadrature). Remove the dc voltmeter and connect the output of the mixer to a spectrum analyzer (Q) tuned to the modulation frequency, 5 kHz. Replace the intentional modulation so that the

carrier is, again, fully suppressed. Record the rms voltage reading ( $V_{\text{rms}}$ ) of the spectrum analyzer.

(d) It is now possible to calculate the calibration factor  $K$ .

$$K = \frac{(\Delta\nu)_{\text{rms}}}{V_{\text{rms}}}, \quad (8H.1)$$

where  $(\Delta\nu)_{\text{rms}}$  is the rms frequency deviation of the carrier due to intentional frequency modulation. This deviation is calculated using the equation

$$(\Delta\nu)_{\text{rms}} = 0.707(\Delta\nu)_{\text{peak}}, \quad (8H.2)$$

where  $(\Delta\nu)_{\text{peak}}$  is the product of the modulation index with the frequency of sinusoidal modulation, i.e.,  $2.405 \times 5 \text{ kHz} = 12.025 \text{ kHz}$ . Therefore the calibration factor in our case is

$$K = \frac{0.707(12.025 \text{ kHz})}{V_{\text{rms}}} = \frac{8.51 \text{ kHz}}{V_{\text{rms}}}. \quad (8H.3)$$

## ANNEX 8.I

### MEASUREMENT PROCEDURE FOR DETERMINING FREQUENCY STABILITY IN THE MICROWAVE REGION

The ensuing detailed steps are given to aid one in determining frequency stability of microwave sources. Referral to figure 8.17 will help in following the sequence of the test procedure. The procedure includes instruction and example on the calculation and presentation of  $S_{\delta\phi}(f)$ .

(a) Be sure the intentional modulation has been completely removed from the X-band source. With the cavity far off resonance, set the level at the

detector to the same value obtained during calibration. Use the variable attenuator (B) for this adjustment. The other variable attenuators (E) and (J) are set to zero.

(b) Adjust the cavity frequency to that frequency of the X-band source. Adjust the phase shifter (F) so that the dc output at the mixer (H) is zero. Attach the spectrum analyzer to the output of the mixer and record rms voltage readings ( $V_{\text{rms}}$ ) for various frequency settings of the spectrum analyzer. A low noise amplifier may be necessary to obtain useful readings at large Fourier frequencies. A second reading ( $V'_{\text{rms}}$ ) should be taken at each value of  $f$  with the signal strongly attenuated in the signal channel. This is to record the residual additive background noise not attributable to actual phase noise on the carrier. This attenuation is accomplished by inserting all ( $> 20 \text{ dB}$ ) of the attenuation in the variable attenuator (J).

(c) In order to calculate values of  $S_{\delta\phi}(f)$  for plotting at various Fourier frequencies, it is convenient to make a tabulation of results. An example of some typical results is given in table 8.I.1. The following relations are used:

$$V_{\text{rms}} = \sqrt{(V'_{\text{rms}})^2 - (V''_{\text{rms}})^2}. \quad (8.I.1)$$

$$\delta\nu_{\text{rms}} = V_{\text{rms}} \times K. \quad (8.I.2)$$

$$S_{\delta\nu}(f) = \frac{(\delta\nu_{\text{rms}})^2}{B}. \quad (8.I.3)$$

where  $B$  is the bandwidth at which the readings were made on the spectrum analyzer, and

$$S_{\delta\phi}(f) = \frac{S_{\delta\nu}(f)}{f^2}. \quad (8.I.4)$$

Values of  $S_{\delta\phi}(f)$  which were calculated this way (table 8.I.1) are plotted in figure 8.18.

TABLE 8.1.1. Tabulation of  $S_{\delta\phi}(f)$  at various Fourier frequencies

$f$ (Hz)	$f^2$ (Hz <sup>2</sup> )	$B$ (Hz)	$v_{rms}$ ( $\mu$ V)	$\delta v_{rms}$ (Hz)	$(\delta v_{rms})^2$ (Hz <sup>2</sup> )	$S_{\delta v}(f)$ (Hz)	$S_{\delta\phi}(f)$ (dB) <sup>a</sup>
$5 \times 10^3$	$2.5 \times 10^7$ (74 dB) <sup>b</sup>	100	660	6.38	40.7	0.41 (-3.9 dB) <sup>c</sup>	-77.9
$2.5 \times 10^3$	$6.2 \times 10^6$ (68 dB)	100	780	7.54	56.9	0.57 (-2.4 dB)	-70.4
$1 \times 10^3$	$1.0 \times 10^6$ (60 dB)	100	1000	9.67	93.5	0.94 (-0.3 dB)	-60.3
640	$4.1 \times 10^5$ (56 dB)	10	1200	11.6	135.0	1.4 (1.5 dB)	-54.5
320	$1.0 \times 10^5$ (50 dB)	10	460	4.45	19.8	2.0 (3.0 dB)	-47.0
210	$4.4 \times 10^4$ (46 dB)	10	580	5.61	31.5	3.2 (5.1 dB)	-40.9
150	$2.2 \times 10^4$ (44 dB)	10	680	6.58	43.3	4.3 (6.3 dB)	-37.7
90	$8.1 \times 10^3$ (39 dB)	1	230	2.22	4.93	4.9 (6.9 dB)	-32.1
40	$1.6 \times 10^3$ (32 dB)	1	300	2.90	8.41	8.4 (9.3 dB)	-22.7
20	400 (26 dB)	1	450	4.35	18.9	19.0 (12.8 dB)	-13.2
10	100 (20 dB)	1	700	6.77	45.8	46.0 (16.6 dB)	-3.4

<sup>a</sup> $S_{\delta\phi}(f)$  is tabulated in decibels relative to 1 radian<sup>2</sup> Hz<sup>-1</sup>

<sup>b</sup>dB relative to 1 Hz<sup>2</sup>

<sup>c</sup>dB relative to 1 Hz<sup>2</sup>Hz<sup>-1</sup>

$$\text{Calibration factor } K = \frac{8.51 \times 10^3 \text{ Hz}}{0.88 \text{ V}} = 9.67 \times 10^3 \text{ Hz/V.}$$

## ANNEX 8.J

### TABLES OF BIAS FUNCTIONS, $B_1$ AND $B_2$ , FOR VARIANCES BASED ON FINITE SAMPLES OF PROC- ESSES WITH POWER LAW SPECTRAL DENSITIES<sup>9</sup>

#### 8.J.1. Description of the Bias Func- tions, $B_1$ and $B_2$

Following Allan [8] consider a random process  $y(t)$  with continuous sample functions. We assume that  $y(t)$  has a spectral density,  $S_y(f)$ , which obeys the law

$$S_y(f) = h|f|^\alpha, f_l < |f| < f_h, \quad (8.J.1)$$

where  $h$  is a constant, the limit frequencies  $f_l$  and  $f_h$  satisfy the relations

$$0 \leq f_l \ll f_h < \infty,$$

and any intervals of time,  $\Delta t$ , of any significance satisfy the relations

$$\frac{1}{f_h} \ll \Delta t \ll \frac{1}{f_l}.$$

In short,  $y(t)$  has a power law spectral density over the entire range of significance.

Consider a measurement process which determines an average value of  $y(t)$  over the interval  $t$  to  $t + \tau$ . That is,

$$\bar{y}(t) = \frac{1}{\tau} \int_t^{t+\tau} y(t') dt'. \quad (8.J.2)$$

One, now, may determine an estimated variance from a group of  $N$  such measurements spaced every  $T$  units of time; that is,

$$\sigma_y^2(N, T, \tau) = \frac{1}{N-1} \sum_{n=1}^N \left\{ \bar{y}(t+nT) - \frac{1}{N} \sum_{k=1}^N \bar{y}(t+kT) \right\}^2 \quad (8.J.3)$$

Allan [8] has shown that under these conditions,

$$\langle \sigma_y^2(N, T, \tau) \rangle \propto \tau^\mu, N \text{ and } T/\tau \text{ constant,}$$

where  $\mu$  is related<sup>10</sup> to  $\alpha$  according to the mapping shown in figure 8.1 (see ref. [8] and [26]). The relation between  $\mu$  and  $\alpha$  may be given as

$$\mu = \begin{cases} -2 & \text{if } \alpha \geq 1 \\ -\alpha - 1 & \text{if } -3 < \alpha \leq 1 \\ \text{not defined} & \text{otherwise.} \end{cases}$$

This mapping involves a simple extension of Allan's work [8] to the range  $0 < \mu < 2$ . This extension was also mentioned in [20].

Allan [8] considered in some detail the case where  $T = \tau$ . This is the case of exactly adjacent sample averages—no "dead time" between measurements. Allan defined a function,  $\chi(N, \mu)$ , as follows

$$\chi(N, \mu) \equiv \frac{\langle \sigma_y^2(N, \tau, \tau) \rangle}{\langle \sigma_y^2(2, \tau, \tau) \rangle}, \quad (8.J.4)$$

where it is again assumed that

$$\langle \sigma_y^2(N, \tau, \tau) \rangle \propto \tau^\mu, N \text{ constant.}$$

Allan shows [8] that experimental evaluations of  $\chi(N, \mu)$  may be used to infer  $\mu$  and hence the spectral type by use of the mapping of figure 8.1.

Since many experiments actually have dead time present, it is of value to make two different extensions of this function,  $\chi(N, \mu)$ . First, define  $B_1(N, r, \mu)$  by the relations

$$B_1(N, r, \mu) \equiv \frac{\langle \sigma_y^2(N, T, \tau) \rangle}{\langle \sigma_y^2(2, T, \tau) \rangle}, \quad (8.J.5)$$

where  $r \equiv T/\tau$  and

$$\langle \sigma_y^2(N, T, \tau) \rangle \propto \tau^\mu, N \text{ and } r \text{ constant.}$$

The second function,  $B_2(r, \mu)$ , is defined according to the relation

$$B_2(r, \mu) \equiv \frac{\langle \sigma_y^2(2, T, \tau) \rangle}{\langle \sigma_y^2(2, \tau, \tau) \rangle}, \quad (8.J.6)$$

where  $r \equiv T/\tau$ . In words,  $B_1$  is the ratio of the expected variance for  $N$  samples to the expected variance for 2 samples (everything else fixed); while  $B_2$  is the ratio of the expected variance with

<sup>9</sup>From Barnes, J. A., Nat. Bur. Stand. (U.S.) Tech. Note 375 (January 1968) [3]; references are identical to those given in the main body of Chapter 8.

<sup>10</sup>It should be noted that in reference [8] the exponent,  $\alpha$ , corresponds to the spectrum of phase fluctuations while variances are taken over average frequency fluctuations. In the present paper,  $\alpha$  is equal to the exponent,  $\alpha$ , in [8] plus two. Thus, in this paper, all considerations are confined to one variable,  $y(t)$  (analogous to frequency in [8]) and the spectral density of  $y$ ,  $S_y(f)$ . This paper does not consider the spectrum of the integral of  $y(t)$ .



dead time to that of no dead time (with  $N=2$  and  $\tau$  held constant). The  $B$ 's, then, reflect bias relative to  $N=2$  rather than  $N=\infty$ . It is apparent that  $B_1(N, r=1, \mu) \equiv \chi(N, \mu)$ .

For the conditions given above and with reference to Allan [8], one may write expressions for both  $B_1$  and  $B_2$ , as follows:

$$B_1(N, r, \mu) = \frac{1 + \sum_{n=1}^{N-1} \frac{N-n}{N(N-1)} \left[ 2|nr|^{\mu+2} - |nr+1|^{\mu+2} - |nr-1|^{\mu+2} \right]}{1 + \frac{1}{2} \left[ 2|r|^{\mu+2} - |r+1|^{\mu+2} - |r-1|^{\mu+2} \right]}; \quad (8.J.7)$$

in particular for  $r=1$ ,

$$B_1(N, 1, \mu) = \frac{N(1-N\mu)}{2(N-1)(1-2\mu)}; \quad (8.J.8)$$

and

$$B_2(r, \mu) = \frac{1 + \frac{1}{2} \left[ 2|r|^{\mu+2} - |r+1|^{\mu+2} - |r-1|^{\mu+2} \right]}{2(1-2\mu)}, \quad (8.J.9)$$

except that by definition,  $B_2(1, \mu) \equiv 1$ . The magnitude bars are essential on the  $r-1$  term when  $r < 1$ , and, indeed, proper. Since Allan was involved with  $r \geq 1$  the magnitude bars were dropped in reference [8].

For  $\mu=0$ , eqs (8.J.7), (8.J.8), and (8.J.9) are indeterminate of form 0/0 and must be evaluated by L'Hospital's rule. Special attention must also be given when expressions of the form  $0^0$  arise.

One may obtain the following results:

$$\begin{aligned} B_1(2, r, \mu) &\equiv 1 \\ B_1(N, r, 2) &= \frac{N(N+1)}{6} \\ B_1(N, 1, 1) &= \frac{N}{2} \\ B_1(N, r, -1) &= 1 \text{ if } r \geq 1 \\ B_1(N, r, -2) &= 1 \text{ if } r \neq 1 \text{ or } 0 \\ B_2(0, \mu) &\equiv 0 \\ B_2(1, \mu) &\equiv 1. \quad B_2(r, 2) = r^2 \\ B_2(r, 1) &= \frac{1}{2}(3r-1) \text{ if } r \geq 1 \\ B_2(r, -1) &= \begin{cases} r & \text{if } 0 \leq r \leq 1 \\ 1 & \text{if } r \geq 1 \end{cases} \\ B_2(r, -2) &= \begin{cases} 0 & \text{if } r = 0 \\ 1 & \text{if } r = 1 \\ 2/3 & \text{otherwise} \end{cases} \end{aligned}$$

Values of the functions  $B_1(N, r, \mu)$  and  $B_2(r, \mu)$  are tabulated on the following pages for values of  $N, r, \mu$  as shown below:

$$\begin{aligned} \mu &= -2.0 \text{ to } 2.0 \text{ in steps of } 0.2; \\ N &= 4, 8, 16, 32, 64, 128, 256, 512, 1024, \infty; \\ r &= 0.001, 0.003, 0.01, 0.03, 0.1, 0.2, 0.4, 0.8, 1, \\ &\quad 1.01, 1.1, 2, 4, 8, 16, 32, 64, 128, 256, 512, \\ &\quad 1024, 2048, \infty. \end{aligned}$$

Figure 8.3 is a graphical representation of  $B_2(r, \mu)$  for  $0 \leq r \leq 2$  and  $-2 \leq \mu \leq 2$ .

### 8.J.1.1. Examples of the Use of the Bias Function

The spectral type, that is, the value of  $\mu$ , may be inferred by varying  $\tau$ , the sample time [8, 26]. Another convenient way, however, of determining the value of  $\mu$  is by using  $B_1(N, r, \mu)$  as follows: calculate an estimate of  $\langle \sigma_y^2(N, T, \tau) \rangle$  and of  $\langle \sigma_y^2(2, T, \tau) \rangle$  and hence  $B_1(N, r, \mu)$ ; then by use of the tables the value of  $\mu$  may be inferred.

Suppose one has an experimental value of  $\langle \sigma_y^2(N_1, T_1, \tau_1) \rangle$  and its spectral type is known—that is,  $\mu$  is known. Suppose also that one wishes to know the variance at some other set of measurement parameters,  $N_2, T_2, \tau_2$ . An unbiased estimate of  $\langle \sigma_y^2(N_2, T_2, \tau_2) \rangle$  may be calculated by the equation:

$$\begin{aligned} &\langle \sigma_y^2(N_2, T_2, \tau_2) \rangle \\ &= \left( \frac{\tau_2}{\tau_1} \right)^\mu \left[ \frac{B_1(N_2, r_2, \mu) B_2(r_2, \mu)}{B_1(N_1, r_1, \mu) B_2(r_1, \mu)} \right] \langle \sigma_y^2(N_1, T_1, \tau_1) \rangle, \end{aligned} \quad (8.J.10)$$

where  $r_1 = T_1/\tau_1$  and  $r_2 = T_2/\tau_2$ .

Obviously one might be interested in  $N_2 = \infty$ . In this case if  $\mu \geq 0$ , the expected value of  $\sigma_y^2(\infty, T_2, \tau_2)$  is also infinite. This is true because,

$$\lim_{N_2 \rightarrow \infty} B_1(N_2, r_2, \mu) = \infty,$$

for  $\mu \geq 0$ .

Also, it should be noted that, for  $\mu=2$ ,  $\langle \sigma_y^2(N, T, \tau) \rangle$  is a function of  $f_1$  for any  $N \geq 2, T, \tau$ , even though  $B_1(N, r, 2)$  and  $B_2(r, 2)$  as determined from eqs (8.J.7), (8.J.8), and (8.J.9) are finite and well behaved [20]. In this region,  $\mu \approx 2$ , the low frequency behavior is critically important.

## 8.J.2. ACKNOWLEDGEMENTS

Acknowledgement is given to Mrs. Bernice Bender who capably assisted in writing the computer programs and evaluated the functions.

TABLE 8.J.1. Functions of  $B_1$  and  $B_2$

The tables are typeset from a computer printout. Each entry for the value of the functions,  $B_1$  and  $B_2$  consists of a decimal number followed by an integer which is the exponent of 10. Ten raised to this power should multiply the decimal number. Thus the table entry "2.752+003" could be written  $2.752 \times 10^3$  or, simply 2752. Similarly, "9.869-001" =  $9.869 \times 10^{-1} = 0.9869$ .

Note for the specific case where  $\mu = -2$ : As can be seen from figure 8.1, the value of  $\alpha$  is ambiguous for this case ( $\alpha \geq +1$ ). The values tabulated for  $\mu = -2$  are for  $\alpha = +2$  (white noise phase modulation). Slight variations occur (of a few percent) in  $B_1(N, r, \mu = -2)$  and  $B_2(r, \mu = -2)$  if  $\alpha = +1$ , and if  $2\pi r f_h$  is not very large compared to 1. If very precise variance information is desired in such a case as  $\alpha = +1$  (flicker noise phase modulation), it is recommended that one use the fundamental equations given in table 8.1.

$B_1(N, r, \mu)$  for  $r=0.001$

$N$										
$\mu$	4	8	16	32	64	128	256	512	1024	$\infty$
2.00	3.333+000	1.200+001	4.533+001	1.760+002	6.933+002	2.752+003	1.097+004	4.378+004	1.749+005	$\infty$
1.80	3.333+000	1.200+001	4.533+001	1.760+002	6.931+002	2.749+003	1.092+004	4.326+004	1.690+005	$\infty$
1.60	3.333+000	1.200+001	4.533+001	1.759+002	6.926+002	2.743+003	1.087+004	4.265+004	1.628+005	$\infty$
1.40	3.333+000	1.200+001	4.532+001	1.758+002	6.916+002	2.734+003	1.078+004	4.187+004	1.560+005	$\infty$
1.20	3.333+000	1.200+001	4.529+001	1.756+002	6.894+002	2.716+003	1.064+004	4.081+004	1.484+005	$\infty$
1.00	3.332+000	1.199+001	4.520+001	1.749+002	6.847+002	2.682+003	1.041+004	3.931+004	1.392+005	$\infty$
0.80	3.328+000	1.195+001	4.497+001	1.733+002	6.743+002	2.617+003	1.001+004	3.708+004	1.276+005	$\infty$
0.60	3.317+000	1.186+001	4.435+001	1.695+002	6.519+002	2.491+003	9.344+003	3.373+004	1.124+005	$\infty$
0.40	3.284+000	1.161+001	4.280+001	1.608+002	6.058+002	2.259+003	8.233+003	2.877+004	9.247+004	$\infty$
0.20	3.200+000	1.101+001	3.943+001	1.435+002	5.220+002	1.875+003	6.563+003	2.200+004	6.786+004	$\infty$
-0.00	3.027+000	9.877+000	3.354+001	1.157+002	3.985+002	1.355+003	4.491+003	1.429+004	4.201+004	$\infty$
-0.20	2.761+001	8.268+000	2.585+001	8.231+001	2.624+002	8.281+002	2.558+003	7.622+003	2.120+004	3.066+005
-0.40	2.450+000	6.549+000	1.837+001	5.269+001	1.520+002	4.365+002	1.235+003	3.399+003	8.860+003	6.507+004
-0.60	2.150+000	5.053+000	1.250+001	3.172+001	8.138+001	2.089+002	5.325+002	1.335+003	3.224+003	1.592+004
-0.80	1.888+000	3.881+000	8.397+000	1.868+001	4.211+001	9.545+001	2.162+002	4.865+002	1.076+003	3.983+003
-1.00	1.667+000	3.000+000	5.667+000	1.100+001	2.167+001	4.300+001	8.567+001	1.710+002	3.417+002	1.000+003
-1.20	1.482+000	2.344+000	3.868+000	6.547+000	1.124+001	1.945+001	3.386+001	5.936+001	1.057+002	2.512+002
-1.40	1.327+000	1.854+000	2.680+000	3.959+000	5.921+000	8.924+000	1.353+001	2.068+001	3.236+001	6.310+001
-1.60	1.198+000	1.487+000	1.890+000	2.442+000	3.185+000	4.179+000	5.511+000	7.317+000	9.946+000	1.585+001
-1.80	1.091+000	1.210+000	1.360+000	1.541+000	1.757+000	2.010+000	2.306+000	2.656+000	3.106+000	3.981+000
-2.00	1.000+000	1.000+000	1.000+000	1.000+000	1.000+000	1.000+000	1.000+000	1.000+000	1.000+000	1.000+000

$B_1(N, r, \mu)$  for  $r=0.003$

$N$										
$\mu$	4	8	16	32	64	128	256	512	1024	$\infty$
2.00	3.333+000	1.200+001	4.533+001	1.760+002	6.933+002	2.752+003	1.097+004	4.378+004	1.749+005	$\infty$
1.80	3.333+000	1.200+001	4.532+001	1.759+002	6.917+002	2.732+003	1.072+004	1.112+004	1.514+005	$\infty$
1.60	3.333+000	1.200+001	4.530+001	1.756+002	6.892+002	2.706+003	1.046+004	3.854+004	1.311+005	$\infty$
1.40	3.333+000	1.199+001	4.526+001	1.752+002	6.853+002	2.671+003	1.015+004	3.596+004	1.132+005	$\infty$
1.20	3.332+000	1.198+001	4.516+001	1.744+002	6.788+002	2.620+003	9.774+003	3.330+004	9.717+004	$\infty$
1.00	3.329+000	1.195+001	4.494+001	1.728+002	6.674+002	2.543+003	9.290+003	3.043+004	8.254+004	$\infty$
0.80	3.321+000	1.189+001	4.446+001	1.696+002	6.473+002	2.425+003	8.645+003	2.721+004	6.875+004	$\infty$
0.60	3.302+000	1.173+001	3.342+001	1.634+002	6.124+002	2.242+003	7.765+003	2.346+004	5.536+004	$\infty$
0.40	3.256+000	1.138+001	4.132+001	1.519+002	5.544+002	1.967+003	6.584+003	1.907+004	4.210+004	$\infty$
0.20	3.157+000	1.069+001	3.753+001	1.330+002	4.667+002	1.589+003	5.103+003	1.414+004	2.927+004	$\infty$
-0.00	2.981+000	9.558+000	3.177+001	1.066+002	3.541+002	1.143+003	3.490+003	9.224+003	1.794+004	$\infty$
-0.20	2.729+000	8.054+000	2.474+001	7.694+001	2.377+002	7.169+002	2.061+003	5.175+003	9.470+003	4.488+004
-0.40	2.435+000	6.454+000	1.790+001	5.052+001	1.425+002	3.955+002	1.058+003	2.511+003	4.330+003	1.142+004
-0.60	2.145+000	5.024+000	1.236+001	3.112+001	7.881+001	1.982+002	4.870+002	1.085+003	1.765+003	3.434+003
-0.80	1.887+000	3.876+000	8.372+000	1.857+001	4.167+001	9.363+001	2.085+002	4.326+002	6.638+002	1.066+003
-1.00	1.667+000	3.000+000	5.667+000	1.100+001	2.167+001	4.300+001	8.567+001	1.637+002	2.368+002	3.333+002
-1.20	1.482+000	2.344+000	3.870+000	6.556+000	1.128+001	1.960+001	3.451+001	6.001+001	8.168+001	1.043+002
-1.40	1.328+000	1.854+000	2.681+000	3.964+000	5.941+000	9.001+000	1.386+001	2.159+001	2.756+001	3.264+001
-1.60	1.199+000	1.487+000	1.890+000	2.443+000	3.191+000	4.205+000	5.623+000	7.711+000	9.174+000	1.021+001
-1.80	1.091+000	1.210+000	1.360+000	1.542+000	1.759+000	2.016+000	2.331+000	2.759+000	3.031+000	3.196+000
-2.00	1.000+000	1.000+000	1.000+000	1.000+000	1.000+000	1.000+000	1.000+000	1.000+000	1.000+000	1.000+000

$B_1(N, r, \mu)$  for  $r=0.010$

$N$										
$\mu$	4	8	16	32	64	128	256	512	1024	$\infty$
2.00	3.333+000	1.200+001	4.533+001	1.760+002	6.933+002	2.752+003	1.097+004	4.378+004	1.749+005	$\infty$
1.80	3.333+000	1.199+001	4.526+001	1.750+002	6.819+002	2.623+003	9.737+003	3.493+004	1.231+005	$\infty$
1.60	3.332+000	1.198+001	4.514+001	1.738+002	6.688+002	2.493+003	8.637+003	2.793+004	8.697+004	$\infty$
1.40	3.330+000	1.196+001	4.494+001	1.720+002	6.530+002	2.359+003	7.640+003	2.234+004	6.169+004	$\infty$
1.20	3.327+000	1.192+001	4.461+001	1.693+002	6.330+002	2.215+003	6.717+003	1.782+004	4.383+004	$\infty$
1.00	3.319+000	1.185+001	4.403+001	1.653+002	6.066+002	2.055+003	5.842+003	1.412+004	3.109+004	$\infty$
0.80	3.302+000	1.170+001	4.303+001	1.590+002	5.708+002	1.869+003	4.991+003	1.104+004	2.189+004	$\infty$
0.60	3.268+000	1.143+001	4.133+001	1.495+002	5.221+002	1.649+003	4.142+003	8.419+003	1.514+004	$\infty$
0.40	3.203+000	1.095+001	3.857+001	1.354+002	4.572+002	1.390+003	3.287+003	6.172+003	1.014+004	$\infty$
0.20	3.089+000	1.018+001	3.448+001	1.162+002	3.763+002	1.097+003	2.446+003	4.263+003	6.453+003	$\infty$
-0.00	2.912+000	9.076+000	2.909+001	9.282+001	2.857+002	7.951+002	1.672+003	2.719+003	3.826+003	$\infty$
-0.20	2.677+000	7.714+000	2.296+001	6.836+001	1.976+002	5.220+002	1.036+003	1.580+003	2.084+003	5.581+003
-0.40	2.407+000	6.279+000	1.703+001	4.655+001	1.247+002	3.106+002	5.814+002	8.357+002	1.043+003	1.715+003
-0.60	2.134+000	4.959+000	1.205+001	2.977+001	7.296+001	1.697+002	2.995+002	4.076+002	4.851+002	6.423+002
-0.80	1.884+000	3.860+000	8.303+000	1.828+001	4.041+001	8.691+001	1.443+002	1.868+002	2.137+002	2.519+002
-1.00	1.667+000	3.000+000	5.667+000	1.100+001	2.167+001	4.255+001	6.628+001	8.190+001	9.064+001	1.000+002
-1.20	1.482+000	2.346+000	3.880+000	6.598+000	1.145+001	2.026+001	2.947+001	3.486+001	3.754+001	3.980+001
-1.40	1.328+000	1.856+000	2.688+000	3.991+000	6.054+000	9.500+000	1.282+001	1.456+001	1.532+001	1.585+001
-1.60	1.199+000	1.487+000	1.893+000	2.455+000	3.239+000	4.440+000	5.505+000	6.002+000	6.198+000	6.309+000
-1.80	1.091+000	1.210+000	1.360+000	1.545+000	1.772+000	2.089+000	2.349+000	2.456+000	2.494+000	2.512+000
-2.00	1.000+000	1.000+000	1.000+000	1.000+000	1.000+000	1.000+000	1.000+000	1.000+000	1.000+000	1.000+000

$B_1(N, r, \mu)$  for  $r=0.030$

$N$										
$\mu$	4	8	16	32	64	128	256	512	1024	$\infty$
2.00	3.333+000	1.200+001	4.533+001	1.760+002	6.933+002	2.752+003	1.097+004	4.378+004	1.749+005	$\infty$
1.80	3.331+000	1.196+001	4.487+001	1.706+002	6.374+002	2.304+003	8.142+003	2.849+004	9.936+004	$\infty$
1.60	3.327+000	1.191+001	4.431+001	1.650+002	5.851+002	1.930+003	6.068+003	1.866+004	5.684+004	$\infty$
1.40	3.320+000	1.184+001	4.360+001	1.588+002	5.352+002	1.615+003	4.535+003	1.228+004	3.276+004	$\infty$
1.20	3.309+000	1.172+001	4.267+001	1.518+002	4.867+002	1.348+003	3.392+003	8.128+003	1.903+004	$\infty$
1.00	3.290+000	1.155+001	4.141+001	1.437+002	4.382+002	1.117+003	2.533+003	5.395+003	1.114+004	$\infty$
0.80	3.257+000	1.128+001	3.966+001	1.339+002	3.887+002	9.152+002	1.879+003	3.580+003	6.554+003	$\infty$
0.60	3.203+000	1.087+001	3.728+001	1.220+002	3.372+002	7.357+002	1.376+003	2.364+003	3.868+003	$\infty$
0.40	3.118+000	1.027+001	3.412+001	1.077+002	2.835+002	5.750+002	9.868+002	1.541+003	2.277+003	$\infty$
0.20	2.992+000	9.460+000	3.013+001	9.127+001	2.286+002	4.324+002	6.856+002	9.834+002	1.328+003	$\infty$
-0.00	2.819+000	8.430+000	2.546+001	7.348+001	1.748+002	3.096+002	4.568+002	6.082+002	7.611+002	$\infty$
-0.20	2.604+000	7.242+000	2.047+001	5.581+001	1.259+002	2.094+002	2.897+002	3.619+002	4.256+002	8.571+002
-0.40	2.362+000	6.005+000	1.566+001	3.993+001	8.524+001	1.335+002	1.744+002	2.066+002	2.314+002	3.099+002
-0.60	2.114+000	4.838+000	1.147+001	2.706+001	5.441+001	8.049+001	9.997+001	1.134+002	1.225+002	1.403+002
-0.80	1.878+000	3.825+000	8.141+000	1.753+001	3.304+001	4.626+001	5.499+001	6.029+001	6.341+001	6.770+001
-1.00	1.667+000	3.000+000	5.667+000	1.100+001	1.928+001	2.560+001	2.929+001	3.127+001	3.229+001	3.333+001
-1.20	1.484+000	2.355+000	3.918+000	6.768+000	1.093+001	1.378+001	1.525+001	1.595+001	1.626+001	1.651+001
-1.40	1.329+000	1.863+000	2.719+000	4.133+000	6.080+000	7.268+000	7.815+000	8.044+000	8.135+000	8.191+000
-1.60	1.199+000	1.491+000	1.910+000	2.532+000	3.341+000	3.782+000	3.963+000	4.030+000	4.053+000	4.064+000
-1.80	1.091+000	1.211+000	1.366+000	1.573+000	1.827+000	1.950+000	1.995+000	2.010+000	2.015+000	2.016+000
-2.00	1.000+000	1.000+000	1.000+000	1.000+000	1.000+000	1.000+000	1.000+000	1.000+000	1.000+000	1.000+000

$B_1(N, r, \mu)$  for  $r=0.100$ 

$N$										
$\mu$	4	8	16	32	64	128	256	512	1024	$\infty$
2.00	3.333+000	1.200+001	4.533+001	1.760+002	6.933+002	2.752+003	1.097+004	4.378+004	1.749+005	$\infty$
1.80	3.315+000	1.174+001	4.252+001	1.517+002	5.330+002	1.858+003	6.467+003	2.250+004	7.830+004	$\infty$
1.60	3.293+000	1.147+001	3.982+001	1.309+002	4.113+002	1.263+003	3.843+003	1.166+004	3.535+004	$\infty$
1.40	3.265+000	1.118+001	3.721+001	1.130+002	3.183+002	8.636+002	2.304+003	6.103+003	1.613+004	$\infty$
1.20	3.230+000	1.084+001	3.463+001	9.728+001	2.470+002	5.943+002	1.394+003	3.232+003	7.453+003	$\infty$
1.00	3.184+000	1.045+001	3.204+001	8.347+001	1.918+002	4.114+002	8.523+002	1.735+003	3.500+003	$\infty$
0.80	3.123+000	9.989+000	2.938+001	7.118+001	1.487+002	2.862+002	5.269+002	9.466+002	1.678+003	$\infty$
0.60	3.043+000	9.445+000	2.663+001	6.014+001	1.149+002	1.999+002	3.295+002	5.265+002	8.254+002	$\infty$
0.40	2.940+000	8.804+000	2.376+001	5.015+001	8.816+001	1.397+002	2.084+002	2.993+002	4.194+002	$\infty$
0.20	2.810+000	8.065+000	2.080+001	4.111+001	6.690+001	9.750+001	1.331+002	1.741+002	2.214+002	$\infty$
-0.00	2.653+000	7.236+000	1.779+001	3.300+001	5.003+001	6.771+001	8.566+001	1.037+002	1.219+002	$\infty$
-0.20	2.472+000	6.344+000	1.481+001	2.585+001	3.673+001	4.664+001	5.542+001	6.314+001	6.989+001	1.156+002
-0.40	2.273+000	5.430+000	1.199+001	1.971+001	2.642+001	3.177+001	3.592+001	3.910+001	4.153+001	4.922+001
-0.60	2.065+000	4.540+000	9.423+000	1.461+001	1.859+001	2.137+001	2.326+001	2.452+001	2.537+001	2.702+001
-0.80	1.860+000	3.720+000	7.204+000	1.055+001	1.281+001	1.419+001	1.502+001	1.550+001	1.577+001	1.616+001
-1.00	1.667+000	3.000+000	5.375+000	7.429+000	8.653+000	9.312+000	9.652+000	9.825+000	9.912+000	1.000+001
-1.20	1.491+000	2.396+000	3.931+000	5.125+000	5.751+000	6.046+000	6.177+000	6.235+000	6.260+000	6.278+000
-1.40	1.337+000	1.907+000	2.832+000	3.477+000	3.772+000	3.892+000	3.938+000	3.954+000	3.960+000	3.962+000
-1.60	1.205+000	1.522+000	2.021+000	2.329+000	2.449+000	2.490+000	2.502+000	2.505+000	2.505+000	2.504+000
-1.80	1.093+000	1.226+000	1.438+000	1.546+000	1.579+000	1.586+000	1.586+000	1.585+000	1.584+000	1.583+000
-2.00	1.000+000	1.000+000	1.000+000	1.000+000	1.000+000	1.000+000	1.000+000	1.000+000	1.000+000	1.000+000

 $|B_1(N, r, \mu)$  for  $r=0.200$ 

$N$										
$\mu$	4	8	16	32	64	128	256	512	1024	$\infty$
2.00	3.333+000	1.200+001	4.533+001	1.760+002	6.933+002	2.752+003	1.097+004	4.378+004	1.749+005	$\infty$
1.80	3.279+000	1.131+001	3.925+001	1.358+002	4.700+002	1.629+003	5.657+003	1.967+004	6.843+004	$\infty$
1.60	3.222+000	1.065+001	3.404+001	1.053+002	3.209+002	9.729+002	2.946+003	8.923+003	2.703+004	$\infty$
1.40	3.162+000	1.002+001	2.955+001	8.204+001	2.208+002	5.868+002	1.552+003	4.096+003	1.081+004	$\infty$
1.20	3.096+000	9.409+000	2.567+001	6.420+001	1.533+002	3.581+002	8.286+002	1.909+003	4.391+003	$\infty$
1.00	3.024+000	8.811+000	2.229+001	5.044+001	1.074+002	2.215+002	4.501+002	9.072+002	1.821+003	$\infty$
0.80	2.942+000	8.219+000	1.933+001	3.977+001	7.593+001	1.392+002	2.496+002	4.420+002	7.771+002	$\infty$
0.60	2.849+000	7.624+000	1.671+001	3.143+001	5.424+001	8.907+001	1.420+002	2.225+002	3.445+002	$\infty$
0.40	2.743+000	7.023+000	1.438+001	2.488+001	3.912+001	5.811+001	8.330+001	1.166+002	1.607+002	$\infty$
0.20	2.622+000	6.414+000	1.229+001	1.969+001	2.847+001	3.870+001	5.054+001	6.421+001	7.994+001	$\infty$
-0.00	2.487+000	5.796+000	1.042+001	1.555+001	2.088+001	2.631+001	3.180+001	3.733+001	4.288+001	$\infty$
-0.20	2.337+000	5.175+000	8.751+000	1.224+001	1.542+001	1.825+001	2.075+001	2.295+001	2.487+001	3.793+001
-0.40	2.176+000	4.558+000	7.262+000	9.581+000	1.143+001	1.287+001	1.399+001	1.484+001	1.550+001	1.757+001
-0.60	2.008+000	3.958+000	5.949+000	7.450+000	8.497+000	9.211+000	9.692+000	1.001+001	1.023+001	1.066+001
-0.80	1.836+000	3.387+000	4.808+000	5.746+000	6.318+000	6.658+000	6.857+000	6.974+000	7.042+000	7.136+000
-1.00	1.667+000	2.857+000	3.833+000	4.395+000	4.692+000	4.845+000	4.922+000	4.961+000	4.980+000	5.000+000
-1.20	1.505+000	2.379+000	3.016+000	3.333+000	3.476+000	3.539+000	3.565+000	3.575+000	3.579+000	3.582+000
-1.40	1.355+000	1.960+000	2.346+000	2.507+000	2.568+000	2.588+000	2.594+000	2.595+000	2.595+000	2.593+000
-1.60	1.221+000	1.601+000	1.805+000	1.873+000	1.890+000	1.892+000	1.890+000	1.889+000	1.888+000	1.886+000
-1.80	1.102+000	1.300+000	1.378+000	1.390+000	1.387+000	1.382+000	1.378+000	1.376+000	1.375+000	1.374+000
-2.00	1.000+000	1.000+000	1.000+000	1.000+000	1.000+000	1.000+000	1.000+000	1.000+000	1.000+000	1.000+000

$B_i(N, r, \mu)$  for  $r=0.400$

$N$										
$\mu$	4	8	16	32	64	128	256	512	1024	$\infty$
2.00	3.333+000	1.200+001	4.533+001	1.760+002	6.933+002	2.752+003	1.097+004	4.378+004	1.749+005	$\infty$
1.80	3.186+000	1.052+001	3.540+001	1.207+002	4.152+002	1.436+003	4.984+003	1.732+004	6.026+004	$\infty$
1.60	3.047+000	9.247+000	2.780+001	8.345+001	2.511+002	7.574+002	2.289+003	6.929+003	2.099+004	$\infty$
1.40	2.915+000	8.151+000	2.197+001	5.825+001	1.536+002	4.046+002	1.066+003	2.810+003	7.412+003	$\infty$
1.20	2.790+000	7.205+000	1.748+001	4.110+001	9.529+001	2.196+002	5.051+002	1.161+003	2.666+003	$\infty$
1.00	2.670+000	6.384+000	1.401+001	2.936+001	6.011+001	1.216+002	2.447+002	4.909+002	9.832+002	$\infty$
0.80	2.555+000	5.670+000	1.131+001	2.126+001	3.868+001	6.908+001	1.221+002	2.144+002	3.752+002	$\infty$
0.60	2.443+000	5.046+000	9.201+000	1.563+001	2.546+001	4.045+001	6.323+001	9.780+001	1.503+002	$\infty$
0.40	2.334+000	4.499+000	7.544+000	1.167+001	1.721+001	2.457+001	3.433+001	4.725+001	6.433+001	$\infty$
0.20	2.227+000	4.017+000	6.232+000	8.870+000	1.196+001	1.556+001	1.973+001	2.454+001	3.009+001	$\infty$
-0.00	2.121+000	3.589+000	5.187+000	6.856+000	8.572+000	1.032+001	1.209+001	1.387+001	1.566+001	$\infty$
-0.20	2.015+000	3.207+000	4.346+000	5.389+000	6.330+000	7.169+000	7.913+000	8.569+000	9.144+000	1.306+001
-0.40	1.909+000	2.864+000	3.664+000	4.305+000	4.811+000	5.208+000	5.516+000	5.753+000	5.936+000	6.518+000
-0.60	1.802+000	2.555+000	3.105+000	3.489+000	3.755+000	3.937+000	4.060+000	4.144+000	4.200+000	4.313+000
-0.80	1.694+000	2.274+000	2.642+000	2.864+000	2.997+000	3.077+000	3.123+000	3.151+000	3.167+000	3.191+000
-1.00	1.583+000	2.018+000	2.254+000	2.376+000	2.438+000	2.469+000	2.484+000	2.492+000	2.496+000	2.500+000
-1.20	1.471+000	1.782+000	1.926+000	1.987+000	2.011+000	2.021+000	2.024+000	2.025+000	2.026+000	2.025+000
-1.40	1.356+000	1.565+000	1.644+000	1.670+000	1.677+000	1.678+000	1.677+000	1.676+000	1.675+000	1.674+000
-1.60	1.240+000	1.363+000	1.401+000	1.408+000	1.408+000	1.406+000	1.404+000	1.403+000	1.402+000	1.402+000
-1.80	1.121+000	1.175+000	1.188+000	1.188+000	1.186+000	1.184+000	1.183+000	1.182+000	1.182+000	1.182+000
-2.00	1.000+000	1.000+000	1.000+000	1.000+000	1.000+000	1.000+000	1.000+000	1.000+000	1.000+000	1.000+000

$B_i(N, r, \mu)$  for  $r=0.800$

$N$										
$\mu$	4	8	16	32	64	128	256	512	1024	$\infty$
2.00	3.333+000	1.200+001	4.533+001	1.760+002	6.933+002	2.752+003	1.097+004	4.378+004	1.749+005	$\infty$
1.80	3.032+000	9.694+000	3.213+001	1.089+002	3.739+002	1.292+003	4.483+003	1.558+004	5.421+004	$\infty$
1.60	2.765+000	7.876+000	2.297+001	6.806+001	2.038+002	6.135+002	1.853+003	5.608+003	1.698+004	$\infty$
1.40	2.529+000	6.441+000	1.658+001	4.305+001	1.125+002	2.953+002	7.770+002	2.047+003	5.398+003	$\infty$
1.20	2.319+000	5.306+000	1.210+001	2.762+001	6.317+001	1.447+002	3.319+002	7.617+002	1.749+003	$\infty$
1.00	2.134+000	4.405+000	8.950+000	1.804+001	3.622+001	7.259+001	1.453+002	2.908+002	5.817+002	$\infty$
0.80	1.969+000	3.688+000	6.718+000	1.203+001	2.132+001	3.753+001	6.579+001	1.150+002	2.008+002	$\infty$
0.60	1.823+000	3.117+000	5.128+000	8.225+000	1.296+001	2.018+001	3.116+001	4.782+001	7.310+001	$\infty$
0.40	1.693+000	2.660+000	3.986+000	5.783+000	8.193+000	1.140+001	1.567+001	2.130+001	2.876+001	$\infty$
0.20	1.578+000	2.293+000	3.160+000	4.196+000	5.416+000	6.840+000	8.492+000	1.040+001	1.260+001	$\infty$
-0.00	1.477+000	1.998+000	2.558+000	3.149+000	3.761+000	4.389+000	5.027+000	5.671+000	6.318+000	$\infty$
-0.20	1.387+000	1.760+000	2.115+000	2.446+000	2.749+000	3.023+000	3.267+000	3.483+000	3.673+000	4.968+000
-0.40	1.308+000	1.568+000	1.786+000	1.966+000	2.112+000	2.229+000	2.321+000	2.392+000	2.447+000	2.624+000
-0.60	1.238+000	1.413+000	1.541+000	1.634+000	1.700+000	1.748+000	1.780+000	1.803+000	1.818+000	1.850+000
-0.80	1.177+000	1.287+000	1.357+000	1.400+000	1.427+000	1.444+000	1.454+000	1.461+000	1.464+000	1.470+000
-1.00	1.125+000	1.187+000	1.219+000	1.234+000	1.242+000	1.246+000	1.248+000	1.249+000	1.250+000	1.250+000
-1.20	1.081+000	1.109+000	1.117+000	1.118+000	1.117+000	1.116+000	1.115+000	1.114+000	1.114+000	1.113+000
-1.40	1.045+000	1.050+000	1.045+000	1.039+000	1.035+000	1.032+000	1.030+000	1.029+000	1.028+000	1.028+000
-1.60	1.017+000	1.010+000	1.000+000	9.922-001	9.872-001	9.843-001	9.827-001	9.819-001	9.814-001	9.809-001
-1.80	1.001+000	9.914-001	9.826-001	9.768-001	9.734-001	9.715-001	9.704-001	9.699-001	9.697-001	9.694-001
-2.00	1.000+000	1.000+000	1.000+000	1.000+000	1.000+000	1.000+000	1.000+000	1.000+000	1.000+000	1.000+000

$B_1(N, r, \mu)$  for  $r=1.00$ 

$N$										
$\mu$	4	8	16	32	64	128	256	512	1024	$\infty$
2.00	3.330+000	1.200+001	4.533+001	1.760+002	6.933+002	2.752+003	1.097+004	4.378+004	1.749+005	$\infty$
1.80	2.988+000	9.490+000	3.138+001	1.063+002	3.646+002	1.260+003	4.372+003	1.519+004	5.286+004	$\infty$
1.60	2.688+000	7.555+000	2.191+001	6.479+001	1.938+002	5.833+002	1.762+003	5.331+003	1.615+004	$\infty$
1.40	2.426+000	6.059+000	1.546+001	3.999+001	1.044+002	2.738+002	7.202+002	1.897+003	5.003+003	$\infty$
1.20	2.198+000	4.900+000	1.104+001	2.506+001	5.717+001	1.308+002	2.999+002	6.881+002	1.580+003	$\infty$
1.00	2.000+000	4.000+000	8.000+000	1.600+001	3.200+001	6.400+001	1.280+002	2.560+002	5.120+002	$\infty$
0.80	1.827+000	3.299+000	5.894+000	1.045+001	1.841+001	3.230+001	5.652+001	9.872+001	1.722+002	$\infty$
0.60	1.677+000	2.750+000	4.424+000	7.006+000	1.096+001	1.698+001	2.614+001	4.005+001	6.114+001	$\infty$
0.40	1.546+000	2.320+000	3.391+000	4.846+000	6.801+000	9.407+000	1.287+001	1.744+001	2.350+001	$\infty$
0.20	1.432+000	1.982+000	2.658+000	3.471+000	4.432+000	5.555+000	6.858+000	8.363+000	1.010+001	$\infty$
0.00	1.333+000	1.714+000	2.133+000	2.581+000	3.048+000	3.528+000	4.016+000	4.509+000	5.005+000	$\infty$
-0.20	1.247+000	1.502+000	1.754+000	1.994+000	2.216+000	2.418+000	2.599+000	2.759+000	2.900+000	3.863+000
-0.40	1.172+000	1.333+000	1.476+000	1.599+000	1.700+000	1.782+000	1.847+000	1.898+000	1.938+000	2.065+000
-0.60	1.107+000	1.197+000	1.271+000	1.327+000	1.370+000	1.401+000	1.422+000	1.438+000	1.448+000	1.470+000
-0.80	1.050+000	1.088+000	1.117+000	1.137+000	1.150+000	1.160+000	1.165+000	1.169+000	1.171+000	1.175+000
-1.00	1.000+000	1.000+000	1.000+000	1.000+000	1.000+000	1.000+000	1.000+000	1.000+000	1.000+000	1.000+000
-1.20	9.569-001	9.284-001	9.105-001	8.997-001	8.933-001	8.897-001	8.877-001	8.866-001	8.860-001	8.854-001
-1.40	9.193-001	8.700-001	8.410-001	8.245-001	8.154-001	8.105-001	8.079-001	8.065-001	8.058-001	8.051-001
-1.60	8.866-001	8.221-001	7.864-001	7.672-001	7.570-001	7.517-001	7.490-001	7.476-001	7.468-001	7.461-001
-1.80	8.581-001	7.827-001	7.431-001	7.226-001	7.122-001	7.068-001	7.042-001	7.028-001	7.021-001	7.014-001
-2.00	8.333-001	7.500-001	7.083-001	6.875-001	6.771-001	6.719-001	6.693-001	6.680-001	6.673-001	6.667-001

 $B_1(N, r, \mu)$  for  $r=1.01$ 

$N$										
$\mu$	4	8	16	32	64	128	256	512	1024	$\infty$
2.00	3.333+000	1.200+001	4.533+001	1.760+002	6.933+002	2.752+003	1.097+004	4.378+004	1.749+005	$\infty$
1.80	2.986+000	9.482+000	3.135+001	1.062+002	3.643+002	1.259+003	4.367+003	1.518+004	5.280+004	$\infty$
1.60	2.685+000	7.542+000	2.187+001	6.466+001	1.934+002	5.822+002	1.758+003	5.321+003	1.611+004	$\infty$
1.40	2.422+000	6.045+000	1.542+001	3.988+001	1.041+002	2.730+002	7.180+002	1.892+003	4.988+003	$\infty$
1.20	2.194+000	4.885+000	1.100+001	2.497+001	5.695+001	1.303+002	2.987+002	6.854+002	1.573+003	$\infty$
1.00	1.995+000	3.985+000	7.966+000	1.593+001	3.185+001	6.369+001	1.274+002	2.547+002	5.095+002	$\infty$
0.80	1.822+000	3.285+000	5.864+000	1.039+001	1.830+001	3.212+001	5.619+001	9.814+001	1.712+002	$\infty$
0.60	1.672+000	2.738+000	4.400+000	6.963+000	1.089+001	1.687+001	2.597+001	3.978+001	6.073+001	$\infty$
0.40	1.541+000	2.309+000	3.371+000	4.814+000	6.754+000	9.340+000	1.277+001	1.731+001	2.332+001	$\infty$
0.20	1.428+000	1.972+000	2.642+000	3.447+000	4.400+000	5.512+000	6.804+000	8.296+000	1.002+001	$\infty$
-0.00	1.329+000	1.706+000	2.120+000	2.563+000	3.025+000	3.500+000	3.984+000	4.472+000	4.963+000	$\infty$
-0.20	1.243+000	1.495+000	1.743+000	1.980+000	2.200+000	2.400+000	2.579+000	2.737+000	2.877+000	3.829+000
-0.40	1.168+000	1.327+000	1.468+000	1.589+000	1.689+000	1.770+000	1.835+000	1.885+000	1.924+000	2.050+000
-0.60	1.104+000	1.193+000	1.265+000	1.321+000	1.362+000	1.393+000	1.414+000	1.429+000	1.440+000	1.461+000
-0.80	1.048+000	1.085+000	1.113+000	1.133+000	1.147+000	1.155+000	1.161+000	1.165+000	1.167+000	1.170+000
-1.00	1.000+000	1.000+000	1.000+000	1.000+000	1.000+000	1.000+000	1.000+000	1.000+000	1.000+000	1.000+000
-1.20	9.599-001	9.331-001	9.160-001	9.056-001	8.995-001	8.960-001	8.940-001	8.929-001	8.924-001	8.917-001
-1.40	9.286-001	8.840-001	8.573-001	8.419-001	8.333-001	8.287-001	8.262-001	8.249-001	8.242-001	8.235-001
-1.60	9.098-001	8.566-001	8.264-001	8.098-001	8.009-001	7.963-001	7.938-001	7.926-001	7.920-001	7.913-001
-1.80	9.156-001	8.682-001	8.425-001	8.288-001	8.217-001	8.181-001	8.162-001	8.153-001	8.148-001	8.143-001
-2.00	1.000+000	1.000+000	1.000+000	1.000+000	1.000+000	1.000+000	1.000+000	1.000+000	1.000+000	1.000+000

$B_1(N, r, \mu)$  for  $r=1.10$

$N$										
$\mu$	4	8	16	32	64	128	256	512	1024	$\infty$
2.00	3.333+000	1.200+001	4.533+001	1.760+002	6.933+002	2.752+003	1.097+004	4.378+004	1.749+005	$\infty$
1.80	2.972+000	9.418+000	3.111+001	1.053+002	3.614+002	1.249+003	4.333+003	1.506+004	5.238+004	$\infty$
1.60	2.660+000	7.443+000	2.154+001	6.366+001	1.904+002	5.730+002	1.731+003	5.237+003	1.586+004	$\infty$
1.40	2.391+000	5.929+000	1.508+001	3.897+001	1.016+002	2.666+002	7.011+002	1.847+003	4.870+003	$\infty$
1.20	2.158+000	4.766+000	1.069+001	2.422+001	5.521+001	1.263+002	2.894+002	6.640+002	1.524+003	$\infty$
1.00	1.957+000	3.870+000	7.696+000	1.535+001	3.065+001	6.126+001	1.225+002	2.449+002	4.898+002	$\infty$
0.80	1.783+000	3.177+000	5.637+000	9.954+000	1.750+001	3.068+001	5.365+001	9.366+001	1.634+002	$\infty$
0.60	1.633+000	2.640+000	4.213+000	6.639+000	1.035+001	1.602+001	2.463+001	3.771+001	5.754+001	$\infty$
0.40	1.504+000	2.223+000	3.219+000	4.575+000	6.398+000	8.828+000	1.205+001	1.632+001	2.197+001	$\infty$
0.20	1.393+000	1.898+000	2.521+000	3.272+000	4.160+000	5.199+000	6.404+000	7.797+000	9.402+000	$\infty$
-0.00	1.298+000	1.643+000	2.026+000	2.435+000	2.863+000	3.304+000	3.752+000	4.205+000	4.661+000	$\infty$
-0.20	1.217+000	1.444+000	1.671+000	1.889+000	2.091+000	2.275+000	2.440+000	2.586+000	2.714+000	3.593+000
-0.40	1.147+000	1.288+000	1.416+000	1.526+000	1.617+000	1.692+000	1.751+000	1.797+000	1.832+000	1.948+000
-0.60	1.088+000	1.166+000	1.230+000	1.281+000	1.319+000	1.346+000	1.366+000	1.379+000	1.389+000	1.408+000
-0.80	1.040+000	1.072+000	1.096+000	1.114+000	1.126+000	1.134+000	1.139+000	1.142+000	1.144+000	1.147+000
-1.00	1.000+000	1.000+000	1.000+000	1.000+000	1.000+000	1.000+000	1.000+000	1.000+000	1.000+000	1.000+000
-1.20	9.696-001	9.482-001	9.341-001	9.254-001	9.201-001	9.171-001	9.154-001	9.145-001	9.140-001	9.134-001
-1.40	9.493-001	9.157-001	8.948-001	8.825-001	8.755-001	8.717-001	8.696-001	8.685-001	8.680-001	8.674-001
-1.60	9.415-001	9.048-001	8.831-001	8.709-001	8.642-001	8.607-001	8.588-001	8.578-001	8.574-001	8.569-001
-1.80	9.527-001	9.243-001	9.082-001	8.994-001	8.948-001	8.924-001	8.911-001	8.905-001	8.902-001	8.898-001
-2.00	1.000+000	1.000+000	1.000+000	1.000+000	1.000+000	1.000+000	1.000+000	1.000+000	1.000+000	1.000+000

$B_1(N, r, \mu)$  for  $r=2.00$

$N$										
$\mu$	4	8	16	32	64	128	256	512	1024	$\infty$
2.00	3.333+000	1.200+001	4.533+001	1.760+002	6.933+002	2.752+003	1.097+004	4.378+004	1.749+005	$\infty$
1.80	2.908+000	9.132+000	3.006+001	1.017+002	3.487+002	1.205+003	4.179+003	1.453+004	5.053+004	$\infty$
1.60	2.552+000	7.012+000	2.014+001	5.935+001	1.773+002	5.334+002	1.611+003	4.874+003	1.476+004	$\infty$
1.40	2.255+000	5.439+000	1.366+001	3.512+001	9.142+001	2.395+002	6.299+002	1.659+003	4.374+003	$\infty$
1.20	2.007+000	4.271+000	9.409+000	2.114+001	4.800+001	1.096+002	2.510+002	5.756+002	1.321+003	$\infty$
1.00	1.800+000	3.400+000	6.600+000	1.300+001	2.580+001	5.140+001	1.026+002	2.050+002	4.098+002	$\infty$
0.80	1.628+000	2.750+000	4.733+000	8.215+000	1.431+001	2.494+001	4.347+001	7.576+001	1.320+002	$\infty$
0.60	1.486+000	2.264+000	3.485+000	5.371+000	8.262+000	1.267+001	1.937+001	2.955+001	4.498+001	$\infty$
0.40	1.369+000	1.901+000	2.644+000	3.659+000	5.025+000	6.847+000	9.267+000	1.247+001	1.670+001	$\infty$
0.20	1.273+000	1.629+000	2.075+000	2.615+000	3.256+000	4.005+000	4.876+000	5.882+000	7.042+000	$\infty$
-0.00	1.195+000	1.427+000	1.688+000	1.971+000	2.267+000	2.573+000	2.884+000	3.198+000	3.515+000	$\infty$
-0.20	1.133+000	1.277+000	1.425+000	1.568+000	1.702+000	1.824+000	1.934+000	2.031+000	2.117+000	2.704+000
-0.40	1.084+000	1.168+000	1.246+000	1.315+000	1.373+000	1.420+000	1.457+000	1.487+000	1.509+000	1.583+000
-0.60	1.046+000	1.090+000	1.126+000	1.156+000	1.178+000	1.195+000	1.207+000	1.215+000	1.221+000	1.233+000
-0.80	1.019+000	1.035+000	1.048+000	1.058+000	1.064+000	1.069+000	1.072+000	1.074+000	1.075+000	1.077+000
-1.00	1.000+000	1.000+000	1.000+000	1.000+000	1.000+000	1.000+000	1.000+000	1.000+000	1.000+000	1.000+000
-1.20	9.886-001	9.799-001	9.738-001	9.699-001	9.675-001	9.661-001	9.653-001	9.648-001	9.646-001	9.643-001
-1.40	9.837-001	9.719-001	9.641-001	9.593-001	9.565-001	9.550-001	9.541-001	9.537-001	9.534-001	9.532-001
-1.60	9.845-001	9.737-001	9.669-001	9.630-001	9.607-001	9.595-001	9.589-001	9.586-001	9.584-001	9.582-001
-1.80	9.901-001	9.836-001	9.796-001	9.774-001	9.761-001	9.755-001	9.752-001	9.750-001	9.749-001	9.748-001
-2.00	1.000+000	1.000+000	1.000+000	1.000+000	1.000+000	1.000+000	1.000+000	1.000+000	1.000+000	1.000+000

$B_1(N, r, \mu)$  for  $r=4.00$

$N$										
$\mu$	4	8	16	32	64	128	256	512	1024	$\infty$
2.00	3.333+000	1.200+001	4.533+001	1.760+002	6.933+002	2.752+003	1.097+004	4.378+004	1.749+005	$\infty$
1.80	2.879+000	9.006+000	2.960+001	1.000+002	3.431+002	1.186+003	4.112+003	1.429+004	4.972+004	$\infty$
1.60	2.504+000	6.819+000	1.952+001	5.745+001	1.715+002	5.160+002	1.558+003	4.714+003	1.428+004	$\infty$
1.40	2.194+000	5.219+000	1.303+001	3.340+001	8.686+001	2.275+002	5.981+002	1.575+003	4.154+003	$\infty$
1.20	1.938+000	4.045+000	8.826+000	1.974+001	4.472+001	1.020+002	2.336+002	5.356+002	1.229+003	$\infty$
1.00	1.727+000	3.182+000	6.091+000	1.191+001	2.355+001	4.682+001	9.336+001	1.865+002	3.726+002	$\infty$
0.80	1.555+000	2.548+000	4.303+000	7.385+000	1.278+001	2.219+001	3.860+001	6.718+001	1.170+002	$\infty$
0.60	1.415+000	2.082+000	3.129+000	4.748+000	7.229+000	1.101+001	1.676+001	2.550+001	3.875+001	$\infty$
0.40	1.303+000	1.742+000	2.356+000	3.196+000	4.326+000	5.834+000	7.837+000	1.049+001	1.399+001	$\infty$
0.20	1.214+000	1.495+000	1.848+000	2.275+000	2.783+000	3.377+000	4.067+000	4.865+000	5.784+000	$\infty$
-0.00	1.144+000	1.318+000	1.514+000	1.726+000	1.949+000	2.179+000	2.414+000	2.651+000	2.890+000	$\infty$
-0.20	1.092+000	1.194+000	1.298+000	1.399+000	1.494+000	1.580+000	1.658+000	1.727+000	1.788+000	2,204+000
-0.40	1.054+000	1.109+000	1.160+000	1.205+000	1.243+000	1.274+000	1.299+000	1.318+000	1.333+000	1.382+000
-0.60	1.027+000	1.053+000	1.075+000	1.093+000	1.107+000	1.117+000	1.124+000	1.129+000	1.132+000	1.140+000
-0.80	1.010+000	1.019+000	1.026+000	1.031+000	1.035+000	1.037+000	1.039+000	1.040+000	1.041+000	1.042+000
-1.00	1.000+000	1.000+000	1.000+000	1.000+000	1.000+000	1.000+000	1.000+000	1.000+000	1.000+000	1.000+000
-1.20	9.953-001	9.916-001	9.890-001	9.873-001	9.862-001	9.856-001	9.853-001	9.851-001	9.850-001	9.849-001
-1.40	9.941-001	9.898-001	9.869-001	9.851-001	9.840-001	9.834-001	9.831-001	9.829-001	9.829-001	9.828-001
-1.60	9.952-001	9.918-001	9.896-001	9.884-001	9.876-001	9.873-001	9.870-001	9.869-001	9.869-001	9.868-001
-1.80	9.974-001	9.957-001	9.946-001	9.940-001	9.936-001	9.935-001	9.934-001	9.933-001	9.933-001	9.933-001
-2.00	1.000+000	1.000+000	1.000+000	1.000+000	1.000+000	1.000+000	1.000+000	1.000+000	1.000+000	1.000+000

$B_1(N, r, \mu)$  for  $r=8.00$

$N$										
$\mu$	4	8	16	32	64	128	256	512	1024	$\infty$
2.00	3.333+000	1.200+001	4.533+001	1.760+002	6.933+002	2.752+003	1.097+004	4.378+004	1.749+005	$\infty$
1.80	2.870+000	8.963+000	2.945+001	9.951+001	3.413+002	1.179+003	4.090+003	1.421+004	4.945+004	$\infty$
1.60	2.486+000	6.751+000	1.930+001	5.678+001	1.695+002	5.099+002	1.540+003	4.658+003	1.411+004	$\infty$
1.40	2.170+000	5.135+000	1.279+001	3.276+001	8.515+001	2.230+002	5.862+002	1.544+003	4.071+003	$\infty$
1.20	1.910+000	3.953+000	8.590+000	1.917+001	4.341+001	9.898+001	2.265+002	5.195+002	1.192+003	$\infty$
1.00	1.696+000	3.087+000	5.870+000	1.143+001	2.257+001	4.483+001	8.935+001	1.784+002	3.565+002	$\infty$
0.80	1.521+000	2.453+000	4.101+000	6.996+000	1.206+001	2.090+001	3.630+001	6.315+001	1.099+002	$\infty$
0.60	1.380+000	1.991+000	2.950+000	4.433+000	6.706+000	1.017+001	1.544+001	2.345+001	3.559+001	$\infty$
0.40	1.268+000	1.657+000	2.202+000	2.946+000	3.949+000	5.286+000	7.062+000	9.414+000	1.252+001	$\infty$
0.20	1.181+000	1.420+000	1.720+000	2.083+000	2.514+000	3.019+000	3.606+000	4.284+000	5.066+000	$\infty$
-0.00	1.116+000	1.255+000	1.413+000	1.584+000	1.763+000	1.969+000	2.137+000	2.328+000	2.520+000	$\infty$
-0.20	1.069+000	1.145+000	1.223+000	1.299+000	1.371+000	1.436+000	1.494+000	1.546+000	1.592+000	1.905+000
-0.40	1.037+000	1.075+000	1.110+000	1.142+000	1.168+000	1.189+000	1.207+000	1.220+000	1.231+000	1.264+000
-0.60	1.017+000	1.033+000	1.047+000	1.058+000	1.067+000	1.073+000	1.078+000	1.081+000	1.083+000	1.088+000
-0.80	1.006+000	1.011+000	1.014+000	1.017+000	1.020+000	1.021+000	1.022+000	1.022+000	1.023+000	1.023+000
-1.00	1.000+000	1.000+000	1.000+000	1.000+000	1.000+000	1.000+000	1.000+000	1.000+000	1.000+000	1.000+000
-1.20	9.980-001	9.963-001	9.952-001	9.945-001	9.940-001	9.938-001	9.936-001	9.935-001	9.935-001	9.934-001
-1.40	9.978-001	9.961-001	9.950-001	9.944-001	9.940-001	9.937-001	9.936-001	9.936-001	9.935-001	9.935-001
-1.60	9.984-001	9.973-001	9.966-001	9.962-001	9.960-001	9.958-001	9.958-001	9.957-001	9.957-001	9.957-001
-1.80	9.993-001	9.988-001	9.985-001	9.983-001	9.982-001	9.981-001	9.981-001	9.981-001	9.981-001	9.981-001
-2.00	1.000+000	1.000+000	1.000+000	1.000+000	1.000+000	1.000+000	1.000+000	1.000+000	1.000+000	1.000+000



$B_i(N, r, \mu)$  for  $r=16.00$

$N$										
$\mu$	4	8	16	32	64	128	256	512	1024	$\infty$
2.00	3.333+000	1.200+001	4.533+001	1.760+002	6.933+002	2.752+003	1.097+004	4.378+004	1.749+005	$\infty$
1.80	2.866+000	8.949+000	2.940+001	9.934+001	3.406+002	1.177+003	4.083+003	1.419+004	4.936+004	$\infty$
1.60	2.480+000	6.727+000	1.923+001	5.654+001	1.688+002	5.077+002	1.533+003	4.639+003	1.405+004	$\infty$
1.40	2.161+000	5.104+000	1.270+001	3.251+001	8.450+001	2.213+002	5.817+002	1.532+003	4.039+003	$\infty$
1.20	1.898+000	3.914+000	8.491+000	1.894+001	4.285+001	9.769+001	2.236+002	5.127+002	1.177+003	$\infty$
1.00	1.681+000	3.043+000	5.766+000	1.121+001	2.211+001	4.389+001	8.747+001	1.746+002	3.489+002	$\infty$
0.80	1.504+000	2.404+000	3.997+000	6.794+000	1.169+001	2.023+001	3.512+001	6.106+001	1.062+002	$\infty$
0.60	1.360+000	1.939+000	2.848+000	4.254+000	6.409+000	9.696+000	1.469+001	2.228+001	3.379+001	$\infty$
0.40	1.247+000	1.606+000	2.108+000	2.794+000	3.717+000	4.950+000	6.587+000	8.754+000	1.162+001	$\infty$
0.20	1.160+000	1.372+000	1.637+000	1.958+000	2.340+000	2.787+000	3.307+000	3.907+000	4.599+000	$\infty$
-0.00	1.097+000	1.214+000	1.346+000	1.489+000	1.639+000	1.794+000	1.952+000	2.112+000	2.273+000	$\infty$
-0.20	1.054+000	1.113+000	1.174+000	1.233+000	1.289+000	1.339+000	1.385+000	1.425+000	1.461+000	1.705+000
-0.40	1.026+000	1.053+000	1.078+000	1.101+000	1.119+000	1.135+000	1.147+000	1.157+000	1.164+000	1.188+000
-0.60	1.011+000	1.021+000	1.030+000	1.037+000	1.043+000	1.047+000	1.050+000	1.052+000	1.053+000	1.056+000
-0.80	1.003+000	1.006+000	1.008+000	1.010+000	1.011+000	1.012+000	1.012+000	1.013+000	1.013+000	1.013+000
-1.00	1.000+000	1.000+000	1.000+000	1.000+000	1.000+000	1.000+000	1.000+000	1.000+000	1.000+000	1.000+000
-1.20	9.991-001	9.984-001	9.979-001	9.976-001	9.974-001	9.973-001	9.972-001	9.972-001	9.972-001	9.971-001
-1.40	9.992-001	9.985-001	9.981-001	9.979-001	9.977-001	9.976-001	9.976-001	9.976-001	9.975-001	9.975-001
-1.60	9.995-001	9.991-001	9.989-001	9.987-001	9.987-001	9.986-001	9.986-001	9.986-001	9.986-001	9.986-001
-1.80	9.998-001	9.997-001	9.996-001	9.995-001	9.995-001	9.995-001	9.995-001	9.995-001	9.995-001	9.995-001
-2.00	1.000+000	1.000+000	1.000+000	1.000+000	1.000+000	1.000+000	1.000+000	1.000+000	1.000+000	1.000+000

$B_i(N, r, \mu)$  for  $r=32.00$

$N$										
$\mu$	4	8	16	32	64	128	256	512	1024	$\infty$
2.00	3.333+000	1.200+001	4.533+001	1.760+002	6.933+002	2.752+003	1.097+004	4.378+004	1.749+005	$\infty$
1.80	2.865+000	8.945+000	2.938+001	9.928+001	3.405+002	1.176+003	4.081+003	1.418+004	4.934+004	$\infty$
1.60	2.478+000	6.719+000	1.920+001	5.646+001	1.685+002	5.070+002	1.531+003	4.632+003	1.403+004	$\infty$
1.40	2.158+000	5.091+000	1.266+001	3.242+001	8.425+001	2.206+002	5.799+002	1.527+003	4.027+003	$\infty$
1.20	1.893+000	3.898+000	8.448+000	1.883+001	4.261+001	9.714+001	2.223+002	5.097+002	1.170+003	$\infty$
1.00	1.674+000	3.021+000	5.716+000	1.111+001	2.188+001	4.344+001	8.656+001	1.728+002	3.453+002	$\infty$
0.80	1.494+000	2.378+000	3.940+000	6.685+000	1.149+001	1.986+001	3.447+001	5.992+001	1.042+002	$\infty$
0.60	1.348+000	1.908+000	2.787+000	4.147+000	6.231+000	9.408+000	1.424+001	2.158+001	3.270+001	$\infty$
0.40	1.233+000	1.572+000	2.046+000	2.693+000	3.565+000	4.729+000	6.275+000	8.320+000	1.102+001	$\infty$
0.20	1.146+000	1.338+000	1.579+000	1.871+000	2.218+000	2.625+000	3.097+000	3.643+000	4.272+000	$\infty$
-0.00	1.083+000	1.184+000	1.297+000	1.420+000	1.550+000	1.683+000	1.819+000	1.957+000	2.095+000	$\infty$
-0.20	1.043+000	1.090+000	1.139+000	1.186+000	1.230+000	1.271+000	1.307+000	1.339+000	1.368+000	1.563+000
-0.40	1.019+000	1.039+000	1.057+000	1.073+000	1.087+000	1.098+000	1.107+000	1.114+000	1.119+000	1.136+000
-0.60	1.007+000	1.014+000	1.019+000	1.024+000	1.028+000	1.030+000	1.032+000	1.033+000	1.034+000	1.036+000
-0.80	1.002+000	1.003+000	1.005+000	1.006+000	1.006+000	1.007+000	1.007+000	1.007+000	1.007+000	1.008+000
-1.00	1.000+000	1.000+000	1.000+000	1.000+000	1.000+000	1.000+000	1.000+000	1.000+000	1.000+000	1.000+000
-1.20	9.996-001	9.993-001	9.991-001	9.990-001	9.989-001	9.988-001	9.988-001	9.988-001	9.988-001	9.988-001
-1.40	9.997-001	9.994-001	9.993-001	9.992-001	9.991-001	9.991-001	9.991-001	9.991-001	9.991-001	9.991-001
-1.60	9.998-001	9.997-001	9.996-001	9.996-001	9.996-001	9.995-001	9.995-001	9.995-001	9.995-001	9.995-001
-1.80	9.999-001	9.999-001	9.999-001	9.999-001	9.999-001	9.998-001	9.998-001	9.998-001	9.998-001	9.998-001
-2.00	1.000+000	1.000+000	1.000+000	1.000+000	1.000+000	1.000+000	1.000+000	1.000+000	1.000+000	1.000+000

$B_1(N, r, \mu)$  for  $r=64.00$

$N$										
$\mu$	4	8	16	32	64	128	256	512	1024	$\infty$
2.00	3.333+000	1.200+001	4.533+001	1.760+002	6.933+002	2.752+003	1.097+004	4.378+004	1.749+005	$\infty$
1.80	2.865+000	8.943+000	2.938+001	9.927+001	3.404+002	1.176+003	4.080+003	1.418+004	4.933+004	$\infty$
1.60	2.477+000	6.716+000	1.919+001	5.644+001	1.685+002	5.067+002	1.530+003	4.630+003	1.402+004	$\infty$
1.40	2.156+000	5.087+000	1.265+001	3.238+001	8.415+001	2.204+002	5.793+002	1.526+003	4.022+003	$\infty$
1.20	1.890+000	3.891+000	8.429+000	1.879+001	4.251+001	9.690+001	2.218+002	5.085+002	1.167+003	$\infty$
1.00	1.670+000	3.010+000	5.691+000	1.105+001	2.177+001	4.322+001	8.611+001	1.719+002	3.435+002	$\infty$
0.80	1.489+000	2.363+000	3.909+000	6.624+000	1.137+001	1.966+001	3.411+001	5.929+001	1.031+002	$\infty$
0.60	1.341+000	1.889+000	2.749+000	4.080+000	6.119+000	9.229+000	1.396+001	2.114+001	3.203+001	$\infty$
0.40	1.224+000	1.548+000	2.003+000	2.624+000	3.461+000	4.578+000	6.060+000	8.023+000	1.062+001	$\infty$
0.20	1.135+000	1.313+000	1.536+000	1.808+000	2.129+000	2.506+000	2.944+000	3.450+000	4.033+000	$\infty$
-0.00	1.073+000	1.161+000	1.261+000	1.369+000	1.482+000	1.600+000	1.719+000	1.840+000	1.961+000	$\infty$
-0.20	1.035+000	1.073+000	1.112+000	1.151+000	1.187+000	1.220+000	1.249+000	1.275+000	1.298+000	1.456+000
-0.40	1.014+000	1.028+000	1.042+000	1.054+000	1.064+000	1.072+000	1.078+000	1.083+000	1.087+000	1.100+000
-0.60	1.005+000	1.009+000	1.013+000	1.016+000	1.018+000	1.020+000	1.021+000	1.022+000	1.022+000	1.024+000
-0.80	1.001+000	1.002+000	1.003+000	1.003+000	1.004+000	1.004+000	1.004+000	1.004+000	1.004+000	1.004+000
-1.00	1.000+000	1.000+000	1.000+000	1.000+000	1.000+000	1.000+000	1.000+000	1.000+000	1.000+000	1.000+000
-1.20	9.998-001	9.997-001	9.996-001	9.995-001	9.995-001	9.995-001	9.995-001	9.995-001	9.995-001	9.995-001
-1.40	9.999-001	9.998-001	9.997-001	9.997-001	9.997-001	9.997-001	9.997-001	9.996-001	9.996-001	9.996-001
-1.60	9.999-001	9.999-001	9.999-001	9.999-001	9.999-001	9.999-001	9.998-001	9.998-001	9.998-001	9.998-001
-1.80	1.000+000	1.000+000	1.000+000	1.000+000	1.000+000	1.000+000	1.000+000	1.000+000	1.000+000	1.000+000
-2.00	1.000+000	1.000+000	1.000+000	1.000+000	1.000+000	1.000+000	1.000+000	1.000+000	1.000+000	1.000+000

$B_1(N, r, \mu)$  for  $r=128.00$

$N$										
$\mu$	4	8	16	32	64	128	256	512	1024	$\infty$
2.00	3.333+000	1.200+001	4.533+001	1.760+002	6.933+002	2.752+003	1.097+004	4.378+004	1.749+005	$\infty$
1.80	2.865+000	8.943+000	2.938+001	9.926+001	3.404+002	1.176+003	4.080+003	1.418+004	4.932+004	$\infty$
1.60	2.477+000	6.715+000	1.919+001	5.643+001	1.684+002	5.067+002	1.530+003	4.629+003	1.402+004	$\infty$
1.40	2.156+000	5.085+000	1.265+001	3.237+001	8.411+001	2.203+002	5.790+002	1.525+003	4.021+003	$\infty$
1.20	1.889+000	3.887+000	8.421+000	1.877+001	4.246+001	9.680+001	2.215+002	5.079+002	1.166+003	$\infty$
1.00	1.668+000	3.005+000	5.679+000	1.103+001	2.172+001	4.311+001	8.589+001	1.714+002	3.426+002	$\infty$
0.80	1.486+000	2.354+000	3.891+000	6.589+000	1.131+001	1.955+001	3.391+001	5.893+001	1.025+002	$\infty$
0.60	1.336+000	1.877+000	2.725+000	4.037+000	6.048+000	9.115+000	1.378+001	2.086+001	3.160+001	$\infty$
0.40	1.217+000	1.532+000	1.973+000	2.576+000	3.388+000	4.471+000	5.909+000	7.813+000	1.033+001	$\infty$
0.20	1.127+000	1.294+000	1.504+000	1.759+000	2.062+000	2.416+000	2.827+000	3.303+000	3.851+000	$\infty$
-0.00	1.065+000	1.144+000	1.232+000	1.329+000	1.430+000	1.534+000	1.640+000	1.748+000	1.856+000	$\infty$
-0.20	1.029+000	1.060+000	1.092+000	1.124+000	1.153+000	1.181+000	1.205+000	1.226+000	1.245+000	1.375+000
-0.40	1.010+000	1.021+000	1.031+000	1.040+000	1.047+000	1.053+000	1.058+000	1.062+000	1.065+000	1.074+000
-0.60	1.003+000	1.006+000	1.008+000	1.010+000	1.012+000	1.013+000	1.014+000	1.014+000	1.015+000	1.015+000
-0.80	1.001+000	1.001+000	1.002+000	1.002+000	1.002+000	1.002+000	1.002+000	1.002+000	1.002+000	1.002+000
-1.00	1.000+000	1.000+000	1.000+000	1.000+000	1.000+000	1.000+000	1.000+000	1.000+000	1.000+000	1.000+000
-1.20	9.999-001	9.999-001	9.998-001	9.998-001	9.998-001	9.998-001	9.998-001	9.998-001	9.998-001	9.998-001
-1.40	1.000+000	9.999-001	9.999-001	9.999-001	9.999-001	9.999-001	9.999-001	9.999-001	9.999-001	9.999-001
-1.60	1.000+000	1.000+000	1.000+000	1.000+000	1.000+000	1.000+000	9.999-001	9.999-001	9.999-001	9.999-001
-1.80	1.000+000	1.000+000	1.000+000	1.000+000	1.000+000	1.000+000	1.000+000	1.000+000	1.000+000	1.000+000
-2.00	1.000+000	1.000+000	1.000+000	1.000+000	1.000+000	1.000+000	1.000+000	1.000+000	1.000+000	1.000+000

$B_1(N, r, \mu)$  for  $r=256.00$

$N$										
$\mu$	4	8	16	32	64	128	256	512	1024	$\infty$
2.00	3.333+000	1.200+001	4.533+001	1.760+002	6.933+002	2.752+003	1.097+004	4.378+004	1.749+005	$\infty$
1.80	2.865+000	8.943+000	2.938+001	9.926+001	3.404+002	1.176+003	4.080+003	1.418+004	4.932+004	$\infty$
1.60	2.477+000	6.715+000	1.919+001	5.642+001	1.684+002	5.066+002	1.530+003	4.629+003	1.402+004	$\infty$
1.40	2.156+000	5.084+000	1.264+001	3.236+001	8.410+001	2.202+002	5.789+002	1.525+003	4.020+003	$\infty$
1.20	1.889+000	3.886+000	8.418+000	1.876+001	4.244+001	9.675+001	2.214+002	5.077+002	1.165+003	$\infty$
1.00	1.668+000	3.003+000	5.673+000	1.101+001	2.169+001	4.305+001	8.578+001	1.712+002	3.421+002	$\infty$
0.80	1.484+000	2.350+000	3.881+000	6.570+000	1.127+001	1.948+001	3.380+001	5.873+001	1.022+002	$\infty$
0.60	1.333+000	1.869+000	2.709+000	4.010+000	6.003+000	9.042+000	1.366+001	2.068+001	3.132+001	$\infty$
0.40	1.212+000	1.520+000	1.952+000	2.541+000	3.335+000	4.394+000	5.800+000	7.662+000	1.012+001	$\infty$
0.20	1.121+000	1.280+000	1.479+000	1.722+000	2.009+000	2.346+000	2.737+000	3.189+000	3.710+000	$\infty$
-0.00	1.059+000	1.130+000	1.210+000	1.296+000	1.388+000	1.482+000	1.577+000	1.674+000	1.772+000	$\infty$
-0.20	1.024+000	1.050+000	1.077+000	1.103+000	1.127+000	1.150+000	1.170+000	1.188+000	1.204+000	1.311+000
-0.40	1.008+000	1.016+000	1.023+000	1.029+000	1.035+000	1.039+000	1.043+000	1.046+000	1.048+000	1.055+000
-0.60	1.002+000	1.004+000	1.005+000	1.007+000	1.008+000	1.008+000	1.009+000	1.009+000	1.010+000	1.010+000
-0.80	1.000+000	1.001+000	1.001+000	1.001+000	1.001+000	1.001+000	1.001+000	1.001+000	1.001+000	1.001+000
-1.00	1.000+000	1.000+000	1.000+000	1.000+000	1.000+000	1.000+000	1.000+000	1.000+000	1.000+000	1.000+000
-1.20	1.000+000	9.999-001	9.999-001	9.999-001	9.999-001	9.999-001	9.999-001	9.999-001	9.999-001	9.999-001
-1.40	1.000+000	1.000+000	1.000+000	1.000+000	1.000+000	1.000+000	1.000+000	9.999-001	9.999-001	9.999-001
-1.60	1.000+000	1.000+000	1.000+000	1.000+000	1.000+000	1.000+000	1.000+000	1.000+000	1.000+000	1.000+000
-1.80	1.000+000	1.000+000	1.000+000	1.000+000	1.000+000	1.000+000	1.000+000	1.000+000	1.000+000	1.000+000
-2.00	1.000+000	1.000+000	1.000+000	1.000+000	1.000+000	1.000+000	1.000+000	1.000+000	1.000+000	1.000+000

$B_1(N, r, \mu)$  for  $r=512.00$

$N$										
$\mu$	4	8	16	32	64	128	256	512	1024	$\infty$
2.00	3.333+000	1.200+001	4.533+001	1.760+002	6.933+002	2.752+003	1.097+004	4.378+004	1.749+005	$\infty$
1.80	2.865+000	8.943+000	2.938+001	9.926+001	3.404+002	1.176+003	4.080+003	1.418+004	4.932+004	$\infty$
1.60	2.477+000	6.714+000	1.919+001	5.642+001	1.684+002	5.066+002	1.530+003	4.628+003	1.402+004	$\infty$
1.40	2.156+000	5.084+000	1.264+001	3.236+001	8.410+001	2.202+002	5.789+002	1.525+003	4.020+003	$\infty$
1.20	1.889+000	3.885+000	8.416+000	1.876+001	4.243+001	9.673+001	2.214+002	5.076+002	1.165+003	$\infty$
1.00	1.667+000	3.001+000	5.670+000	1.101+001	2.168+001	4.303+001	8.572+001	1.711+002	3.419+002	$\infty$
0.80	1.483+000	2.347+000	3.875+000	6.558+000	1.125+001	1.945+001	3.373+001	5.862+001	1.020+002	$\infty$
0.60	1.331+000	1.864+000	2.699+000	3.992+000	5.973+000	8.994+000	1.359+001	2.056+001	3.114+001	$\infty$
0.40	1.209+000	1.512+000	1.936+000	2.516+000	3.296+000	4.338+000	5.721+000	7.553+000	9.973+000	$\infty$
0.20	1.116+000	1.268+000	1.460+000	1.692+000	1.967+000	2.290+000	2.665+000	3.098+000	3.598+000	$\infty$
-0.00	1.054+000	1.118+000	1.191+000	1.270+000	1.353+000	1.438+000	1.526+000	1.614+000	1.703+000	$\infty$
-0.20	1.020+000	1.042+000	1.064+000	1.086+000	1.107+000	1.125+000	1.142+000	1.157+000	1.170+000	1.261+000
-0.40	1.006+000	1.012+000	1.017+000	1.022+000	1.026+000	1.030+000	1.032+000	1.034+000	1.036+000	1.041+000
-0.60	1.001+000	1.003+000	1.004+000	1.004+000	1.005+000	1.006+000	1.006+000	1.006+000	1.006+000	1.007+000
-0.80	1.000+000	1.000+000	1.001+000	1.001+000	1.001+000	1.001+000	1.001+000	1.001+000	1.001+000	1.001+000
-1.00	1.000+000	1.000+000	1.000+000	1.000+000	1.000+000	1.000+000	1.000+000	1.000+000	1.000+000	1.000+000
-1.20	1.000+000	1.000+000	1.000+000	1.000+000	1.000+000	1.000+000	1.000+000	1.000+000	1.000+000	1.000+000
-1.40	1.000+000	1.000+000	1.000+000	1.000+000	1.000+000	1.000+000	1.000+000	1.000+000	1.000+000	1.000+000
-1.60	1.000+000	1.000+000	1.000+000	1.000+000	1.000+000	1.000+000	1.000+000	1.000+000	1.000+000	1.000+000
-1.80	1.000+000	1.000+000	1.000+000	1.000+000	1.000+000	1.000+000	1.000+000	1.000+000	1.000+000	1.000+000
-2.00	1.000+000	1.000+000	1.000+000	1.000+000	1.000+000	1.000+000	1.000+000	1.000+000	1.000+000	1.000+000

$B_1(N, r, \mu)$  for  $r=1024.00$ 

$N$										
$\mu$	4	8	16	32	64	128	256	512	1024	$\infty$
2.00	3.333+000	1.200+001	4.533+001	1.760+002	6.933+002	2.752+003	1.097+004	4.378+004	1.749+005	$\infty$
1.80	2.865+000	8.943+000	2.938+001	9.926+001	3.404+002	1.176+003	4.080+003	1.418+004	4.932+004	$\infty$
1.60	2.477+000	6.714+000	1.919+001	5.642+001	1.684+002	5.066+002	1.530+003	4.628+003	1.402+004	$\infty$
1.40	2.156+000	5.084+000	1.264+001	3.236+001	8.409+001	2.202+002	5.789+002	1.525+003	4.020+003	$\infty$
1.20	1.889+000	3.885+000	8.416+000	1.876+001	4.243+001	9.672+001	2.213+002	5.075+002	1.165+003	$\infty$
1.00	1.667+000	3.001+000	5.668+000	1.100+001	2.167+001	4.301+001	8.569+001	1.711+002	3.418+002	$\infty$
0.80	1.482+000	2.345+000	3.872+000	6.552+000	1.124+001	1.942+001	3.369+001	5.855+001	1.018+002	$\infty$
0.60	1.330+000	1.860+000	2.693+000	3.980+000	5.953+000	8.963+000	1.354+001	2.049+001	3.102+001	$\infty$
0.40	1.206+000	1.505+000	1.924+000	2.497+000	3.268+000	4.297+000	5.663+000	7.472+000	9.862+000	$\infty$
0.20	1.112+000	1.259+000	1.444+000	1.668+000	1.934+000	2.245+000	2.607+000	3.025+000	3.507+000	$\infty$
-0.00	1.049+000	1.108+000	1.175+000	1.248+000	1.324+000	1.402+000	1.483+000	1.564+000	1.645+000	$\infty$
-0.20	1.017+000	1.035+000	1.054+000	1.073+000	1.090+000	1.106+000	1.120+000	1.132+000	1.144+000	1.220+000
-0.40	1.004+000	1.009+000	1.013+000	1.017+000	1.020+000	1.022+000	1.024+000	1.026+000	1.027+000	1.031+000
-0.60	1.001+000	1.002+000	1.003+000	1.003+000	1.003+000	1.004+000	1.004+000	1.004+000	1.004+000	1.004+000
-0.80	1.000+000	1.000+000	1.000+000	1.000+000	1.000+000	1.000+000	1.000+000	1.000+000	1.000+000	1.000+000
-1.00	1.000+000	1.000+000	1.000+000	1.000+000	1.000+000	1.000+000	1.000+000	1.000+000	1.000+000	1.000+000
-1.20	1.000+000	1.000+000	1.000+000	1.000+000	1.000+000	1.000+000	1.000+000	1.000+000	1.000+000	1.000+000
-1.40	1.000+000	1.000+000	1.000+000	1.000+000	1.000+000	1.000+000	1.000+000	1.000+000	1.000+000	1.000+000
-1.60	1.000+000	1.000+000	1.000+000	1.000+000	1.000+000	1.000+000	1.000+000	1.000+000	1.000+000	1.000+000
-1.80	1.000+000	1.000+000	1.000+000	1.000+000	1.000+000	1.000+000	1.000+000	1.000+000	1.000+000	1.000+000
-2.00	1.000+000	1.000+000	1.000+000	1.000+000	1.000+000	1.000+000	1.000+000	1.000+000	1.000+000	1.000+000

 $B_1(N, r, \mu)$  for  $r=2048.00$ 

$N$										
$\mu$	4	8	16	32	64	128	256	512	1024	$\infty$
2.00	3.333+000	1.200+001	4.533+001	1.760+002	6.933+002	2.752+003	1.097+004	4.378+004	1.749+005	$\infty$
1.80	2.865+000	8.943+000	2.938+001	9.926+001	3.404+002	1.176+003	4.080+003	1.418+004	4.932+004	$\infty$
1.60	2.477+000	6.714+000	1.919+001	5.642+001	1.684+002	5.066+002	1.530+003	4.628+003	1.402+004	$\infty$
1.40	2.156+000	5.084+000	1.264+001	3.236+001	8.409+001	2.202+002	5.789+002	1.525+003	4.020+003	$\infty$
1.20	1.889+000	3.885+000	8.415+000	1.875+001	4.243+001	9.672+001	2.213+002	5.075+002	1.165+003	$\infty$
1.00	1.667+000	3.000+000	5.667+000	1.100+001	2.167+001	4.301+001	8.568+001	1.710+002	3.417+002	$\infty$
0.80	1.482+000	2.345+000	3.870+000	6.548+000	1.123+001	1.941+001	3.367+001	5.851+001	1.018+002	$\infty$
0.60	1.329+000	1.858+000	2.688+000	3.972+000	5.941+000	8.942+000	1.351+001	2.044+001	3.095+001	$\infty$
0.40	1.204+000	1.501+000	1.916+000	2.483+000	3.247+000	4.266+000	5.620+000	7.412+000	9.780+000	$\infty$
0.20	1.108+000	1.251+000	1.431+000	1.648+000	1.906+000	2.209+000	2.560+000	2.966+000	3.434+000	$\infty$
-0.00	1.045+000	1.100+000	1.162+000	1.229+000	1.299+000	1.372+000	1.446+000	1.521+000	1.596+000	$\infty$
-0.20	1.014+000	1.030+000	1.046+000	1.061+000	1.076+000	1.089+000	1.101+000	1.112+000	1.122+000	1.186+000
-0.40	1.003+000	1.007+000	1.010+000	1.012+000	1.015+000	1.017+000	1.018+000	1.019+000	1.020+000	1.023+000
-0.60	1.001+000	1.001+000	1.002+000	1.002+000	1.002+000	1.002+000	1.003+000	1.003+000	1.003+000	1.003+000
-0.80	1.000+000	1.000+000	1.000+000	1.000+000	1.000+000	1.000+000	1.000+000	1.000+000	1.000+000	1.000+000
-1.00	1.000+000	1.000+000	1.000+000	1.000+000	1.000+000	1.000+000	1.000+000	1.000+000	1.000+000	1.000+000
-1.20	1.000+000	1.000+000	1.000+000	1.000+000	1.000+000	1.000+000	1.000+000	1.000+000	1.000+000	1.000+000
-1.40	1.000+000	1.000+000	1.000+000	1.000+000	1.000+000	1.000+000	1.000+000	1.000+000	1.000+000	1.000+000
-1.60	1.000+000	1.000+000	1.000+000	1.000+000	1.000+000	1.000+000	1.000+000	1.000+000	1.000+000	1.000+000
-1.80	1.000+000	1.000+000	1.000+000	1.000+000	1.000+000	1.000+000	1.000+000	1.000+000	1.000+000	1.000+000
-2.00	1.000+000	1.000+000	1.000+000	1.000+000	1.000+000	1.000+000	1.000+000	1.000+000	1.000+000	1.000+000

$B_1(N, r, \mu)$  for  $r = \infty$ 

$N$										
$\mu$	4	8	16	32	64	128	256	512	1024	$\infty$
2.00	3.333+000	1.200+001	4.533+001	1.760+002	6.933+002	2.752+003	1.097+004	4.378+004	1.749+005	$\infty$
1.80	2.865+000	8.943+000	2.938+001	9.926+001	3.404+002	1.176+003	4.080+003	1.418+004	4.932+004	$\infty$
1.60	2.477+000	6.714+000	1.919+001	5.642+001	1.684+002	5.066+002	1.530+003	4.628+003	1.402+004	$\infty$
1.40	2.156+000	5.084+000	1.264+001	3.236+001	8.409+001	2.202+002	5.789+002	1.525+003	4.020+003	$\infty$
1.20	1.889+000	3.885+000	8.415+000	1.875+001	4.243+001	9.672+001	2.213+002	5.075+002	1.165+003	$\infty$
1.00	1.667+000	3.000+000	5.667+000	1.100+001	2.167+001	4.300+001	8.567+001	1.710+002	3.417+002	$\infty$
0.80	1.482+000	2.343+000	3.867+000	6.543+000	1.123+001	1.940+001	3.364+001	5.846+001	1.017+002	$\infty$
0.60	1.327+000	1.854+000	2.680+000	3.958+000	5.916+000	8.903+000	1.344+001	2.034+001	3.080+001	$\infty$
0.40	1.198+000	1.487+000	1.890+000	2.441+000	3.184+000	4.174+000	5.489+000	7.231+000	9.533+000	$\infty$
0.20	1.091+000	1.210+000	1.360+000	1.541+000	1.757+000	2.009+000	2.303+000	2.642+000	3.033+000	$\infty$
-0.00	1.000+000	1.000+000	1.000+000	1.000+000	1.000+000	1.000+000	1.000+000	1.000+000	1.000+000	1.000+000
-0.20	1.000+000	1.000+000	1.000+000	1.000+000	1.000+000	1.000+000	1.000+000	1.000+000	1.000+000	1.000+000
-0.40	1.000+000	1.000+000	1.000+000	1.000+000	1.000+000	1.000+000	1.000+000	1.000+000	1.000+000	1.000+000
-0.60	1.000+000	1.000+000	1.000+000	1.000+000	1.000+000	1.000+000	1.000+000	1.000+000	1.000+000	1.000+000
-0.80	1.000+000	1.000+000	1.000+000	1.000+000	1.000+000	1.000+000	1.000+000	1.000+000	1.000+000	1.000+000
-1.00	1.000+000	1.000+000	1.000+000	1.000+000	1.000+000	1.000+000	1.000+000	1.000+000	1.000+000	1.000+000
-1.20	1.000+000	1.000+000	1.000+000	1.000+000	1.000+000	1.000+000	1.000+000	1.000+000	1.000+000	1.000+000
-1.40	1.000+000	1.000+000	1.000+000	1.000+000	1.000+000	1.000+000	1.000+000	1.000+000	1.000+000	1.000+000
-1.60	1.000+000	1.000+000	1.000+000	1.000+000	1.000+000	1.000+000	1.000+000	1.000+000	1.000+000	1.000+000
-1.80	1.000+000	1.000+000	1.000+000	1.000+000	1.000+000	1.000+000	1.000+000	1.000+000	1.000+000	1.000+000
-2.00	1.000+000	1.000+000	1.000+000	1.000+000	1.000+000	1.000+000	1.000+000	1.000+000	1.000+000	1.000+000

 $B_2(r, \mu)$ 

$r$									
$\mu$	0.001	0.003	0.010	0.030	0.100	0.200	0.400	0.800	
2.00	1.000-006	9.000-006	1.000-004	9.000-004	1.000-002	4.000-002	1.600-001	6.400-001	
1.80	1.072-006	9.645-006	1.072-004	9.642-004	1.070-002	4.263-002	1.686-001	6.525-001	
1.60	1.152-006	1.037-005	1.152-004	1.036-003	1.147-002	4.547-002	1.776-001	6.652-001	
1.40	1.245-006	1.120-005	1.244-004	1.118-003	1.233-002	4.860-002	1.871-001	6.781-001	
1.20	1.356-006	1.221-005	1.355-004	1.216-003	1.333-002	5.207-002	1.972-001	6.910-001	
1.00	1.500-006	1.349-005	1.495-004	1.337-003	1.450-002	5.600-002	2.080-001	7.040-001	
0.80	1.698-006	1.524-005	1.683-004	1.493-003	1.593-002	6.052-002	2.196-001	7.170-001	
0.60	2.001-006	1.788-005	1.955-004	1.708-003	1.773-002	6.583-002	2.321-001	7.299-001	
0.40	2.530-006	2.228-005	2.381-004	2.020-003	2.006-002	7.219-002	2.457-001	7.426-001	
0.20	3.594-006	3.048-005	3.100-004	2.494-003	2.316-002	7.996-002	2.607-001	7.549-001	
-0.00	6.065-006	4.745-005	4.404-004	3.250-003	2.742-002	8.962-002	2.773-001	7.667-001	
-0.20	1.260-005	8.606-005	6.921-004	4.507-003	3.340-002	1.018-001	2.959-001	7.775-001	
-0.40	3.174-005	1.809-004	1.204-003	6.664-003	4.195-002	1.175-001	3.168-001	7.869-001	
-0.60	9.231-005	4.280-004	2.288-003	1.047-002	5.438-002	1.379-001	3.407-001	7.944-001	
-0.80	2.949-004	1.101-003	4.662-003	1.735-002	7.271-002	1.646-001	3.682-001	7.992-001	
-1.00	1.000-003	3.000-003	1.000-002	3.000-002	1.000-001	2.000-001	4.000-001	8.000-001	
-1.20	3.525-003	8.489-003	2.225-002	5.362-002	1.410-001	2.472-001	4.371-001	7.954-001	
-1.40	1.276-002	2.467-002	5.081-002	9.828-002	2.032-001	3.104-001	4.808-001	7.832-001	
-1.60	4.708-002	7.306-002	1.183-001	1.836-001	2.979-001	3.956-001	5.324-001	7.606-001	
-1.80	1.762-001	2.195-001	2.793-001	3.479-001	4.431-001	5.107-001	5.936-001	7.236-001	
-2.00	6.667-001	6.667-001	6.667-001	6.667-001	6.667-001	6.667-001	6.667-001	6.667-001	

$B_2(r, \mu)$ 

$r$								
$\mu$	1.00	1.01	1.10	2.00	4.00	8.00	16.00	32.00
2.00	1.000+000	1.020+000	1.210+000	4.000+000	1.600+001	6.400+001	2.560+002	1.024+003
1.80	1.000+000	1.019+000	1.198+000	3.642+000	1.289+001	4.513+001	1.574+002	5.485+002
1.60	1.000+000	1.018+000	1.186+000	3.316+000	1.039+001	3.188+001	9.706+001	2.947+002
1.40	1.000+000	1.017+000	1.174+000	3.018+000	8.389+000	2.259+001	6.008+001	1.590+002
1.20	1.000+000	1.016+000	1.162+000	2.747+000	6.784+000	1.607+001	3.741+001	8.644+001
1.00	1.000+000	1.015+000	1.150+000	2.500+000	5.500+000	1.150+001	2.350+001	4.750+001
0.80	1.000+000	1.014+000	1.138+000	2.275+000	4.475+000	8.297+000	1.495+001	2.653+001
0.60	1.000+000	1.013+000	1.126+000	2.071+000	3.658+000	6.051+000	9.673+000	1.516+001
0.40	1.000+000	1.012+000	1.114+000	1.886+000	3.007+000	4.473+000	6.404+000	8.951+000
0.20	1.000+000	1.011+000	1.102+000	1.718+000	2.489+000	3.364+000	4.365+000	5.514+000
-0.00	1.000+000	1.010+000	1.089+000	1.566+000	2.078+000	2.581+000	3.082+000	3.582+000
-0.20	1.000+000	1.009+000	1.075+000	1.429+000	1.752+000	2.027+000	2.265+000	2.472+000
-0.40	1.000+000	1.007+000	1.060+000	1.304+000	1.494+000	1.633+000	1.738+000	1.817+000
-0.60	1.000+000	1.006+000	1.043+000	1.192+000	1.290+000	1.351+000	1.392+000	1.418+000
-0.80	1.000+000	1.004+000	1.024+000	1.091+000	1.128+000	1.148+000	1.159+000	1.166+000
-1.00	1.000+000	1.000+000	1.000+000	1.000+000	1.000+000	1.000+000	1.000+000	1.000+000
-1.20	1.000+000	9.929-001	9.693-001	9.181-001	8.990-001	8.912-001	8.879-001	8.865-001
-1.40	1.000+000	9.776-001	9.281-001	8.446-001	8.192-001	8.103-001	8.071-001	8.058-001
-1.60	1.000+000	9.429-001	8.708-001	7.787-001	7.561-001	7.494-001	7.472-001	7.465-001
-1.80	1.000+000	8.614-001	7.883-001	7.196-001	7.062-001	7.028-001	7.018-001	7.015-001
-2.00	1.000+000	6.667-001	6.667-001	6.667-001	6.667-001	6.667-001	6.667-001	6.667-001

 $B_2(r, \mu)$ 

$r$							
$\mu$	64.00	128.00	256.00	512.00	1024.00	2048.00	$\infty$
2.00	4.096+003	1.638+004	6.554+004	2.621+005	1.049+006	4.194+006	$\infty$
1.80	1.910+003	6.653+003	2.317+004	8.067+004	2.809+005	9.783+005	$\infty$
1.60	8.937+002	2.710+003	8.215+003	2.490+004	7.550+004	2.288+005	$\infty$
1.40	4.201+002	1.109+003	2.928+003	7.727+003	2.039+004	5.381+004	$\infty$
1.20	1.991+002	4.579+002	1.052+003	2.418+003	5.555+003	1.277+004	$\infty$
1.00	9.550+001	1.915+002	3.835+002	7.675+002	1.536+003	3.071+003	$\infty$
0.80	4.669+001	8.179+001	1.429+002	2.493+002	4.346+002	7.570+002	$\infty$
0.60	2.348+001	3.609+001	5.521+001	8.418+001	1.281+002	1.946+002	$\infty$
0.40	1.231+001	1.674+001	2.260+001	3.031+001	4.050+001	5.395+001	$\infty$
0.20	6.834+000	8.351+000	1.009+001	1.209+001	1.439+001	1.704+001	$\infty$
-0.00	4.082+000	4.582+000	5.082+000	5.582+000	6.082+000	6.582+000	$\infty$
-0.20	2.652+000	2.809+000	2.945+000	3.064+000	3.167+000	3.258+000	3.863+000
-0.40	1.877+000	1.923+000	1.957+000	1.983+000	2.003+000	2.018+000	2.065+000
-0.60	1.436+000	1.447+000	1.455+000	1.460+000	1.463+000	1.465+000	1.470+000
-0.80	1.170+000	1.172+000	1.173+000	1.174+000	1.174+000	1.174+000	1.175+000
-1.00	1.000+000	1.000+000	1.000+000	1.000+000	1.000+000	1.000+000	1.000+000
-1.20	8.859-001	8.856-001	8.855-001	8.854-001	8.854-001	8.854-001	8.854-001
-1.40	8.053-001	8.052-001	8.051-001	8.851-001	8.051-001	8.051-001	8.051-001
-1.60	7.462-001	7.462-001	7.461-001	7.461-001	7.461-001	7.461-001	7.461-001
-1.80	7.015-001	7.014-001	7.014-001	7.014-001	7.014-001	7.014-001	7.014-001
-2.00	6.667-001	6.667-001	6.667-001	6.667-001	6.667-001	6.667-001	6.667-001

## CHAPTER 9

### THE NATIONAL BUREAU OF STANDARDS ATOMIC TIME SCALE: GENERATION, STABILITY, ACCURACY AND ACCESSIBILITY\*●

David W. Allan,<sup>†</sup> James E. Gray,<sup>†</sup> and Howard E. Machlan<sup>†</sup>

#### Contents

	Page
9.1. Introduction.....	207
9.2. Basic Time and Frequency Considerations.....	208
9.3. Clock Modeling.....	208
9.3.1. Deterministic Properties.....	208
9.3.2. Random Perturbation of a Clock's Time.....	209
9.3.3. Clock Noise Characterization and Data Simulation.....	212
9.4. The AT (NBS) Time Scale System.....	214
9.4.1. The NBS Primary Frequency Standard and Measurement System.....	214
9.4.2. The Clock Ensemble and Time Difference System.....	215
9.4.3. Atomic Time Scale Algorithms.....	215
9.5. The UTC (NBS) Coordinated Scale.....	220
9.6. UTC (NBS) Accessibility.....	221
9.7. The International Atomic Time Scale (TAI).....	223
9.8. Conclusions.....	223
9.9. References.....	224
Annex 9. A. Optimum Filters for Various Noise Processes (Eq (9.19)).....	225
Annex 9. B. Time Dispersion with Recursive Filter Applied to Flicker Noise FM.....	226
Annex 9. C. Mini-Computer Program for First Order Time Scale Algorithm.....	227
Annex 9. D. Selected Bibliography on Time Scales and Their Formation.....	230

\*Manuscript received January 15, 1973; revised May 15, 1973.

● This chapter was presented in part as a paper at the Precision Electromagnetic Measurements Conference (CPEM), Boulder, CO, June 1972. A small part of the chapter includes material from "The National Bureau of Standards atomic time scales: generation, dissemination, stability and accuracy," published in *IEEE Trans. on Instrum. and Meas.*, November 1972 (see ref. B6). Material is republished at concurrence of the IEEE.

<sup>†</sup> Time and Frequency Division, Institute for Basic Standards, National Bureau of Standards, Boulder, CO 80302.

“Go wond’rous creature, mount where science guides,  
Go, measure earth, weigh air and state the tides;  
Instruct the planets in what orbs to run,  
Correct old time, and regulate the sun,”

Pope’s *Essay on Man*

The atomic time scale at the National Bureau of Standards, AT(NBS), depends upon an ensemble of continuously operating cesium clocks calibrated occasionally by an NBS primary frequency standard. The data of frequency calibrations and interclock comparisons are statistically processed to provide near-optimum time stability and frequency accuracy. The noise spectrum of each clock is represented by a simple mathematical model, with parameters determined by the behavior of that clock. These noise parameters are used in a nearly optimum procedure for periodically recalibrating the frequency of each clock and for combining the clock readings to produce AT(NBS). The long-term fractional frequency stability of AT(NBS) is estimated to be a few parts in  $10^{13}$ , and the accuracy is inferred to be 1 part in  $10^{12}$ .

A small coordinate rate is added to the rate of AT(NBS) to generate UTC(NBS); this small addition is for the purpose of maintaining synchronization within a few microseconds of other international timing centers. Today, UTC(NBS) is operationally available over a large part of the world via; WWV, WWVH, WWVB, and telephone; some time transfer systems, e.g., Loran-C and the TV line-10 system; and experimental systems such as the ATS-3 satellite. We indicate the precision and accuracy of these dissemination systems.

The clocks composing AT(NBS) provide part of the input into the International Atomic Time scale (TAI). The TAI scale is described and new proposals for improvement of this time scale are discussed. Many of the concepts and algorithms developed in this chapter may be directly applicable to the construction of a TAI scale in conformity to the SI unit of time.

Key words: AT(NBS); atomic clock; atomic time scale; clock ensemble; primary frequency standard; SI second; TAI; time/frequency dissemination; time scale; time scale algorithms; UTC(NBS).



## 9.1. INTRODUCTION

Although the atomic definition of the Système International (SI) Second has been accepted internationally, several differing techniques have been advanced for the construction and maintenance of atomic time scales. These varied techniques capitalize to different degrees on such factors as accuracy, stability, modeling and simulation of atomic clocks, availability and cost and, to a large extent, where developed within particular circumstances of given laboratories. Such techniques include a time scale averaged over a multiplicity of selected commercial cesium beam clocks [1],<sup>1</sup> continuous use of a long-beam, primary cesium standard (laboratory) for generation of a time scale more nearly in conformity with SI [2], maintenance of a time scale generated by an ensemble of statistically weighted cesium atomic clocks which are periodically compared to an evaluable primary frequency standard (laboratory) [3, 4], and establishment of a statistically weighted atomic time scale based on some 7 International atomic time scales (International Atomic Time—TAI) [5]. The independent atomic time scale at the National Bureau of Standards, AT(NBS), depends upon an ensemble of continuously operating cesium clocks calibrated occasionally by an NBS primary frequency standard from which the AT(NBS) scale derives its accuracy. The stability of the ensemble between calibrations is of fundamental importance.

The instabilities of each clock in the ensemble may be bicategorized: First, there are deterministic processes that should be considered for each clock; e.g., frequency and time offsets, changes in these offsets, and frequency drift. Changes or drifts in frequency may be estimated by referring to the definition of time across the ensemble and/or with reference to a primary standard. Second, there are random fluctuations (nondeterministic). The noise spectrum of these random fluctuations for each clock is deduced by comparing each clock with all the others. A simple mathematical model reasonably represents this noise spectrum with parameters determined by the random behavior of each clock. These noise parameters provide near optimum filtering of each clock's noise and give a best estimate (in the sense of minimum squared error of prediction) of the apparent time and frequency of each clock with respect to the clock ensemble. Knowledge of the noise spectrum for each clock allows an estimate of the noise of the ensemble; the long-term random fluctuation of the fractional frequency of AT(NBS) are estimated to be a few parts in  $10^{14}$ , whereas, the instability due to deterministic process are estimated to be less than about  $2 \times 10^{-13}$ /year.

The inaccuracy of a primary frequency standard may also be bicategorized. In an evaluation of the parameters which affect the frequency of the primary standard, there are two factors associated with each parameter; i.e., a bias (possibly zero) and a random uncertainty in our knowledge of its effect. If the time scale has excellent stability, one can average the random portion (in an appropriate weighted sense) of all the frequency calibrations with a primary frequency standard.

The AT(NBS) scale in overview is an ensemble of eight commercial cesium beam clocks maintained independently. The clocks are statistically weighted (i.e., filtered) to generate a time scale, AT(NBS), with nearly optimum stability. This scale is used as a memory for frequency in utilizing all of the frequency calibrations with respect to an NBS primary frequency standard. These calibrations are then used after appropriate weighting and filtering to determine the proper<sup>2</sup> rate and the accuracy of the AT(NBS) scale. This scale, along with the atomic time scales of six other laboratories, is used to generate the International Atomic Time Scale, TAI, at the Bureau International de l'Heure (BIH)[5].

In conjunction with the AT(NBS) proper time scale, we also generate the coordinate time scale, UTC(NBS). This latter scale is both synchronized (coordinated) to within a few microseconds of the UTC(BIH) scale and mutually coordinated with the UTC(USNO) scale. This coordination is accomplished by small discrete rate changes (of the order of  $10^{-13}$ ) in UTC(NBS) and in UTC(USNO). One second time jumps are made as announced by the BIH for keeping these scales within 0.7s of the UT1 scale [6] (see chap. 1).

The UTC(NBS) scale is used as the reference for time and frequency broadcasts of the National Bureau of Standards. The time of this scale and frequencies derived therefrom are currently made available via sundry methods: e.g., the two radio transmitters at Ft. Collins, Colo., WWV and WWVB [7, 8]; the radio transmitters at Kekaha, Kauai, Hawaii, WWVH; portable clocks [9]; both the television color subcarrier and line-10 time transfer systems [10, 11]; telephone (303) 499-7111; and the experimental ATS-3 satellite [12], which broadcasts time and frequency information with a format similar to that of WWV and WWVH. The future holds many possibilities of providing time and frequency information including an active TV line-21 system, a relay satellite system, and a time code on the Omega transmissions.

The chapter discusses basic ideas inherent in consideration of an atomic time scale including terminology, statistical clock modeling, and realization of a near optimum atomic time scale. The discussion includes topics such as deterministic

<sup>1</sup> Figures in brackets indicate the literature references at the end of this chapter.

<sup>2</sup> Proper is used here in the relativistic sense.

properties, random perturbations of a clock's time, and atomic time scale algorithms. There is a detailed description of the NBS atomic time scales including their derivation and stability. Also, there is a brief discussion of the TAI and its stability; the ensemble analysis has relevance to the composite International Atomic Time (TAI) scale. The chapter includes a description of the UTC(NBS) time scale, its accessibility, and a comparison of accuracy, coverage, cost, etc. for different methods of access. The annexes at the end of the chapter give detailed derivations and an example of a computer program of a time scale algorithm.

## 9.2. BASIC TIME AND FREQUENCY CONSIDERATIONS

At this point we will review some basic time and frequency ideas described in other chapters of this monograph. Time—as a fundamental parameter in physics—almost always appears as an independent variable in any of the physical laws involving time. In contrast; it is our intent to derive *time*, i.e., we will express time as a dependent variable. Explicitly, time will be a function of how a particular clock ensemble and frequency standard are utilized. (A *clock* is a frequency standard coupled to a divider or counter.) This functional dependence may clearly be formalized by introducing some fundamental concepts of time.

First is the concept of *time interval*. Currently, the SI unit of time, the second, “is the duration of 9 192 631 770 periods of the radiation corresponding to the transition between the two hyperfine levels of the ground state of the cesium-133 atom” as defined by the General Conference of Weights and Measures [13]. Since the frequency of the radiation corresponding to the above transition,  $\nu$ , has also been defined as 9 192 631 770 Hz, we retain the convenient relationship that  $\nu_I = 1/\tau_I$ , and we see simply how a frequency standard is also a time interval standard. The second concept is that of *date*, clock reading, or clock time which often has been called epoch.<sup>3</sup> Date is simply the counting or accumulation—starting from some predetermined origin—of unit time intervals.

Explicitly, the date,  $t$ , is a counting of the periods of the above defined cesium transition; i.e.,

$$t = N_I \tau_I + t_0, \quad (9.1)$$

where  $t_0$  denotes some defined and/or agreed upon date of an event when the counting started,  $N_I$  is the number of periods that have occurred since  $t_0$ , and  $\tau_I$  is the ideal period given by the defined cesium resonance. The ideal proper time of a clock is, therefore, given by  $t$  in eq (9.1).

<sup>3</sup> See discussion of date and epoch in Chapter 1.

A third concept is *simultaneity*: Two events are simultaneous if equivalent signals, propagating in a given media arrive coincidentally at a common point in space which is geometrically an equal distance from the source of each event. In practice a much broader definition is often used for clock synchronization; i.e., two clocks have the same reading in a specific reference frame.

In any discussion of an atomic time scale it is essential that there be understanding as to the basic terms of reference and terminology. Such terms include *accuracy*, *stability*, *precision*, and *reproducibility*. The reader is referred to Chapter 8 for comprehensive definitions of these expressions.

## 9.3. CLOCK MODELING

In this section we will assume that we have a perfect clock reference denoted by  $t$ . In theory when we assume certain clock models and simulate data based on those models the above assumption is totally valid. In practice we make an effort to approach its total validity.

As it is often much easier to deal with residuals, we will refer to a clock's time difference from the ideal (or its estimation of the ideal in practice). This section describes deterministic properties, random perturbations of a clock's time, and clock noise characterization and data simulation.

### 9.3.1. Deterministic Properties

Deterministic properties indicate frequency offset or time drift, frequency or time jumps and other kinds of clock aging. We consider various aspects of such factors below:

a. *Accuracy and precision of synchronization*. The apparent time of the  $i$ th clock is:

$$t_i = N_i \tau_i + T_i(t_0) + t_0, \quad (9.2)$$

where  $T_i(t_0)$  denotes the difference from ideal time of its reading at  $t_0$ ,  $N_i$  is the number of its periods that have transpired since  $t_0$  and  $\tau_i$  is the period of the  $i$ th clock (the number of seconds per cycle). The accuracy of its reading at a particular time  $t$  is given by the actual value of  $T_i(t) = t_i - t$  (how well it is synchronized); whereas, the time precision is given by the uncertainties in how well the value of  $T_i(t)$  is known. If the rate of the  $i$ th clock is correct ( $\tau_i = \tau_I$ ), then the accuracy and precision at any time  $t$  are limited only by the accuracy and precision at the origin,  $T_i(t_0)$ —essentially unrealizable in practice.

b. *Accuracy and precision of clock rate or frequency*. If the frequency of the  $i$ th clock is not correct ( $\tau_i \neq \tau_I$ ) but is constant then the reading of the clock will diverge from the ideal reference. The residual time difference  $T_i(t) = t_i - t$  will be

given by:

$$T_i(t) = N_i\tau_i - N_i\tau_I + T_i(t_0), \quad (9.3)$$

which may be rewritten as

$$T_i(t) = R_i \times [t - t_0] + T_i(t_0). \quad (9.4)$$

$R_i$  denotes the relative rate offset of the  $i$ th clock; e.g., a particular clock may differ in frequency such that it runs fast + 8.64 nanoseconds per day (86400s). This relative rate offset is equivalent to the fractional frequency which we will denote by  $y_i$  (in this case  $y_i = 10^{-13}$ ), where

$$y_i = \frac{\nu_i - \nu_I}{\nu_I}. \quad (9.5)$$

The accuracy of the fractional frequency of the  $i$ th clock is given by an estimate of  $y_i$ ; whereas, the precision of its fractional frequency is given by the uncertainties in how well the value of  $y_i$  is known.

c. *Frequency drift of a clock.* Essentially, all quartz crystal oscillators and rubidium gas cell frequency standards exhibit nonzero linear frequency drift [14]. Recently there has been documentation of the same phenomena in some commercial cesium beam frequency standards [2], and we will give additional documentation later in this chapter. Obviously, in this case the rate does not remain constant and we must modify eq (9.4) to give the following model:

$$T_i(t) = \frac{1}{2}D_i \times [t - t_0]^2 + R_i(t_0) \times [t - t_0] + T_i(t_0), \quad (9.6)$$

where  $D_i$  is the fractional frequency drift per unit time and is here assumed constant. Note, the rate is now specified at a particular date.

d. *Other deterministic perturbations.* Occasionally—due to some perturbation either external or internal—a clock will manifest a different drift rate, a step change in its rate, or a step in its time. Mechanisms and/or methods to detect these kinds of perturbations should therefore be employed in order to affect a uniform time scale. In Section 9.4.3 we will discuss some possible methods of detection.

### 9.3.2. Random Perturbation of a Clock's Time

After the deterministic processes are properly assessed and accounted for in a clock, there will still remain a time deviation from this deterministic model, e.g., see eq (9.6). These deviations or fluctuations will be classified as random. Later, a causal relationship may be found which will account for some part of these deviations, but until such time, it is useful to use statistical techniques to categorize

these random processes. This section describes the random (nondeterministic) fluctuations in a time scale; it gives statistical tools for modeling frequency stability and time dispersion.

a. *Statistical Models for Frequency Stability.* As a general model of clock behavior, let  $x(t)$  denote these random deviations, and we will add this term to (9.6) to give:

$$T_i(t) = \frac{1}{2}D_i \times [t - t_0]^2 + R_i(t_0) \times [t - t_0] + T_i(t_0) + x_i(t). \quad (9.7)$$

Dr. James A. Barnes has conducted some tests on the distribution of  $x(t)$  for cesium and quartz clocks, and in those cases it was found to be normal. If we can assume normality, and know the spectral density or the auto-correlation function for  $x(t)$ , we would then have a complete statistical description of this process. Most high performance clocks can be well modeled statistically with a power law spectral density; i.e.

$$S_y(f) = h_\alpha |f|^\alpha, \quad (9.8)$$

where  $f$  is the Fourier frequency,  $h_\alpha$  is the amplitude of the spectral density for a particular power law  $\alpha$ , and  $S_y(f)$  denotes the one-sided spectral density of the fractional frequency fluctuations  $y$ , and  $y$  is normally distributed [15, 16]. It should be noted that equation (9.5) for  $y_i$  is a fractional frequency offset, where  $y$  denotes fluctuations. The two designations differ only by a delta function at zero Fourier frequency, which is uninteresting and has caused little or no confusion in the past.

Typically, clock data (time or phase points) are taken in the time-domain; and time-domain stability measures involving auto-correlation functions are useful. In particular, we have employed the Allan variance [15, 16]:

$$\langle \sigma_y^2(N, T, \tau, f_h) \rangle = \left\langle \frac{1}{N-1} \left[ \sum_{j=1}^N y_j^2 - \frac{1}{N} \left( \sum_{j=1}^N y(j) \right)^2 \right] \right\rangle, \quad (9.9)$$

where  $y(j)$  is the  $j$ th data point in a sequence of fractional frequency data samples each of which is averaged over a nominal time  $\tau$  and at a sampling rate  $1/T$ ;  $f_h$  is the high frequency cutoff (the measurement system's effective bandwidth), and the angle brackets denote infinite time average. Two convenient relations may quickly be shown by setting  $N=2$  and  $T=\tau$  in eq (9.9), and we then have,

$$\langle \sigma_y^2(2, \tau, \tau, f_h) \rangle \equiv \sigma_y^2(\tau) = \left\langle \frac{[y(j+1) - y(j)]^2}{2} \right\rangle, \quad (9.10)$$

or

$$\sigma_y^2(\tau) = \frac{1}{2\tau^2} [4U_x(\tau) - U_x(2\tau)], \quad (9.11)$$

where

$$U_x(\tau) = \langle [x(t) - x(t+\tau)]^2 \rangle. \quad (9.12)$$

Note, that  $f_h$  is not explicitly indicated as a variable in eqs (9.10)–(9.12), because typically it is held constant for a given experiment; none-the-less, its value should be stated. Though the data may have been taken with  $T \neq \tau$ , it is often possible to convert eq (9.9) for any  $N$ ,  $T$ , and  $\tau$  to that given by eq (9.10) (see ref. [17], also chap. 8). This particular auto-correlation function  $U_x(\tau)$  is useful in dealing with some of the low frequency divergent power law spectral densities; viz., flicker noise frequency modulation [18]. Using the appropriate Fourier transform relationships one can write the following:

$$\sigma_y^2(\tau) = \frac{2h_\alpha}{(\pi\tau)^2} \int_0^{f_h} df f^{\alpha-2} \sin^4(\pi\tau f), \quad (9.13)$$

where the spectral density is given by eq (9.8) and  $\alpha$  is greater than  $-3$  [16]. Equation (9.10) is a very simple time-domain calculation (the infinite time average is normally well approximated with a few hundred data points in a sequence). Equation (9.13) gives a convenient relationship between these frequency-domain and time-domain measures of stability. For further details see Chapter 8 or reference [16].

b. *Statistical Models for Time Dispersion.* Typically the greatest contribution to the time dispersion in a clock comes from the first two terms on the right of eq (9.7); i.e., frequency drift and frequency offset. If, however, these can be measured to first order and accounted for, then the last term  $x(t)$  becomes the primary contribution to the time dispersion. In practice, of course, the first three terms of eq (9.7) are observed only in the presence of the noise,  $x(t)$ . If the spectral character of the noise is known, then in principle one could design an optimum filter in some sense to best examine the signal for frequency drift, frequency offset, and time residual through the noise. In contrast, improper use of the time data from a clock may result in much larger errors than from optimal usage of the statistical data. In such sense, this is a fairly classical problem in signal detection in the presence of noise.

We will illustrate the above using the simple case of white noise frequency modulation [ $S_y(f) = h_0$ ]. For this case eq (9.12) takes the form  $U_x(\tau) = \frac{h_0}{2}\tau$ ,

and therefore:

$$\sigma_y^2(\tau) = \frac{h_0}{2\tau}. \quad (9.14)$$

It is easily shown that for this kind of noise the optimum estimate of a clock's rate (i.e., the signal) over a calibration interval  $\tau_c$  is obtained by simply using the time of the clock at the beginning and end of the interval; i.e.,

$$\hat{R}_i \left( t - \frac{\tau_c}{2} \right) = \frac{T_i(t) - T_i(t - \tau_c)}{\tau_c}, \quad (9.15)$$

where the “ $\hat{\phantom{R}}$ ” over the  $R_i$  indicates an estimate. The mean-square time error realized by using this equation is given by

$$\langle \epsilon_i^2(\tau) \rangle = \langle [\hat{T}_i(t+\tau) - T_i(t+\tau)]^2 \rangle, \quad (9.16)$$

where  $\hat{T}_i(t+\tau)$  denotes the time residual calculated from the rate given by eq (9.15), linear prediction rather than the exact rate. Equation (9.16), after substitutions and time averages are taken, becomes

$$\langle \epsilon_i^2(\tau) \rangle = \frac{1}{\tau_c^2} [\tau_c(\tau_c + \tau)U_{x_i}(\tau) + \tau(\tau_c + \tau)U_{x_i}(\tau_c) - \tau_c\tau U_{x_i}(\tau_c + \tau)]. \quad (9.17)$$

After substituting the above value of  $U_x(\tau)$  for white noise frequency modulation (FM), eq (9.17) becomes

$$\langle \epsilon_i^2(\tau) \rangle = [\sigma_{y_i}^2(\tau_c)] [\tau_c + \tau]\tau. \quad (9.18)$$

Let us examine three cases for eq (9.18); viz.,

$$\langle \epsilon_i^2(\tau) \rangle \cong \tau_c \sigma_{y_i}^2(\tau_c) \tau, \quad \tau < \tau_c. \quad (9.18a)$$

$$\langle \epsilon_i^2(\tau) \rangle = 2\sigma_{y_i}^2(\tau_c) \tau_c^2, \quad \tau = \tau_c. \quad (9.18b)$$

$$\langle \epsilon_i^2(\tau) \rangle \cong \sigma_{y_i}^2(\tau_c) \tau^2, \quad \tau \gg \tau_c. \quad (9.18c)$$

Note two things: first, the squared error is twice as large if the calibration interval is only equal to  $\tau$ , the prediction interval, (eq (9.18b)) as compared to having a very long calibration interval relative to the size of  $\tau$  (eq (9.18a)); second, the squared error disperses as  $\tau^2$  if the calibration interval is much shorter than  $\tau$  (eq (9.18c)), which points out that the dispersion is not due to the noise after the calibration, but rather to the noise during the calibration causing an

TABLE 9.1. Frequency-Domain and Time-Domain Characteristics of Various Power Laws

Power Laws	Characterization			
	$S_v(f)$	$\sigma_y^2(\tau)$	$U_x(\tau)$	$\langle \epsilon_{opt}^2(\tau) \rangle$
White Noise PM	$h_2 f^2$	$\frac{3h_2 f_h}{(2\pi)^2 \tau^2}$	$\frac{2h_2 f_h}{(2\pi)^2}$	$\sim \text{Constant}$
Flicker Noise PM	$h_1 f$	$\frac{h_1}{(2\pi)^2 \tau^2} [9/2 + 3 \ln(2\pi f_h \tau) - \ln(2)]$	$\frac{2h_1}{(2\pi)^2} [9/2 + 3 \ln(2\pi f_h \tau) - \ln(2)]$	$\sim \text{Constant} + \ln(\tau)$
Random Walk PM or White Noise FM	$h_0$	$\frac{h_0}{2\tau}$	$\frac{h_0}{2} \tau$	$\sim \tau$
Flicker Noise FM	$h_{-1} f^{-1}$	$2h_{-1} \ln(2)$	$\lim_{\alpha \rightarrow -1} \frac{2h_{-1} \ln(2) \tau^{-\alpha+1}}{2-2^{-\alpha}}$	$\sim \tau^2$
Random Walk FM	$h_{-2} f^{-2}$	$\frac{(2\pi)^2}{6} h_{-2} \tau$	$-\frac{(2\pi)^2}{12} h_{-2} \tau^3$	$\sim \tau^3$

PM = Phase Modulation; FM = Frequency Modulation; for White Noise PM and Flicker Noise PM we assume  $\tau f_h \gg 1$ .

error in determining the clock's rate,  $\hat{R}_i\left(t - \frac{\tau_c}{2}\right)$ , over too short a calibration interval. Data can be and often are misused in this manner—yielding a much greater time dispersion than would be necessary.

It is useful to tabulate some of the common kinds of power law noise processes which perturb the outputs of the high performance clocks currently available. In table 9.1 these power laws are listed along with their frequency-domain and time-domain characterization. The equation for  $U_x(\tau)$  and the basic behavior for the mean square time dispersion after optimal data usage are also listed in table 9.1. It should be clearly noted that the time dispersion is dependent upon how the data are utilized, and in some cases it is highly dependent, as illustrated above for white noise FM, where for too short a calibration interval the mean square time dispersion goes as  $\tau^2$  rather than as  $\tau$ .

White noise PM and Flicker noise PM are typically the predominant noise processes for values of  $\tau$  less than 1 second; e.g., in quartz crystal oscillators and hydrogen maser frequency standards. For longer than one second, the predominant noise processes are usually white noise FM, flicker noise FM, and in some cases random walk FM. One or more of these last three noise processes are applicable in many frequency standards; e.g., cesium beam, hydrogen maser, rubidium gas cell, quartz crystal oscillator, and probably any oscillator

stabilized by a passive frequency resonance as in the methane stabilized helium-neon laser.

Figure 9.1, showing some time-domain stability characteristics of various frequency standards measured at NBS, illustrates most of the above kinds of noise processes. As a stability plot is analyzed, it is useful to note and it may be shown [15, 16, 19] that if:  $\sigma_y^2(\tau) \sim \tau^\mu$ , then

$$\mu = \begin{cases} -2, & \text{for } \alpha \geq 1 \text{ and } |\tau f_h| \gg 1; \\ -\alpha - 1, & \text{for } -3 > \alpha \leq 1. \end{cases} \quad (9.19)$$

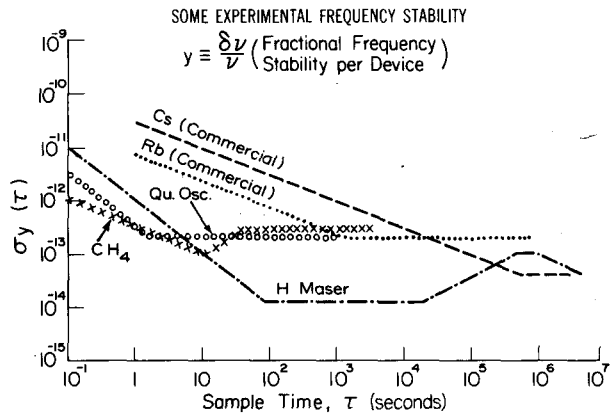

FIGURE 9.1. Fractional frequency stability of several types of oscillators as a function of sample time.

Annex 9.A considers an optimum filter (optimum in the sense of giving a minimum squared error of time prediction  $\langle \epsilon_{\text{opt}}^2(\tau) \rangle$ ) in detail for each of the above kinds of noise processes. If a process can be reduced to that of white noise through linear transformation, then the simple mean of the transformation gives the optimum predictor for this white noise process. By taking the inverse transform, one can generate the optimum filtered output for minimum squared error time prediction for the process itself [20].

At this point we will illustrate a very simple recursive relationship which yields near optimum time prediction for some important practical instances. Consider specifically the noise process for  $\alpha = -1$ ; this is a noise type commonly observed in long term in high performance clocks. In this case  $\sigma_y^2(\tau)$  is independent of  $\tau$ . (We will not treat the case where  $\alpha = 1$  as it has much less relevance for timekeeping; however, the same principles apply to both flicker noise FM and flicker noise PM).

Consider a sequence of measurements of the fractional frequency on the  $i$ th clock,  $y_i(j)$ , where the  $j$  denotes the particular member of the sequence as in eq (9.9). An exponential weighting of the past measurements to yield a near optimum estimate for the current frequency of an  $\alpha = -1$  noise process is given approximately by the following recursion relationship [21];

$$\hat{y}(j) = \frac{1}{m+1} [y_i(j) + m\hat{y}_i(j-1)]. \quad (9.20)$$

The time constant of the exponential weighting filter is given by  $m$ . The general expression for the squared error of prediction is given by:

$$\begin{aligned} \langle \epsilon^2(\tau) \rangle = & U_x(\tau) + \frac{U_x(\tau)}{m^2} \sum_{k=1}^{\infty} \left( \frac{m}{m+1} \right)^{2k} \\ & - \frac{2}{m} \sum_{k=1}^{\infty} \left( \frac{m}{m+1} \right)^k \left\{ \frac{1}{2} [U_x((k+1)\tau) \right. \\ & \left. + U_x((k-1)\tau)] - U_x(k\tau) \right\} \\ & + \frac{2}{m^2} \sum_{kl}^{\infty} \left( \frac{m}{m+1} \right)^k \left( \frac{m}{m+1} \right)^l \\ & \left\{ \frac{1}{2} [U_x((l-k-1)\tau) + U_x((l-k+1)\tau)] \right. \\ & \left. - U_x((l-k)\tau) \right\}. \end{aligned} \quad (9.21)$$

For a given noise process and a given prediction interval  $\tau$ , there exists a value of  $m$  which will give a minimum squared error for eq (9.21).

Substituting the equation for  $U_x(\tau)$  for flicker noise FM ( $\alpha = -1$ ) from table 9.1 into eq (9.21) and choosing the optimum value of  $m$  ( $m = 0.6$  for  $\alpha = -1$ ) yields the result that the root-mean-squared error given by eq (9.21) is only a factor of 1.13 times larger than that for an optimum prediction routine. The residual time calculation is based on the operationally very simple recursion relationship for the rate given in eq (9.20).

### 9.3.3. Clock Noise Characterization and Data Simulation

Once the deterministic and random properties of a clock have been estimated, then it is possible to simulate a clock's behavior. The simulation of the deterministic part is, of course, very straightforward using, step, ramp, and quadratic functions. The random portion, characterized by power law spectral densities ( $S_y(f) = h_\alpha f^\alpha$ ), may be simulated using Gaussian white noise generators and the white noise to flicker noise filters, including integrals of the same [22]. The deterministic part of a clock's behavior is usually well modeled by eq (9.6). Quite commonly we find that the random part,  $x(t)$ , is well modeled by the following equation (see fig. 9.1):

$$S_y(f) = h_0 + h_{-1} f^{-1}, \quad (9.22)$$

or in the time-domain:

$$\sigma_y^2(\tau) = \frac{h_0}{2} \tau^{-1} + h_{-1} 2 \ln(2), \quad (9.23)$$

where

$$y(t) = \frac{dx(t)}{dt}. \quad (9.23a)$$

Assuming the statistical model of eqs (9.22) and (9.23), we will calculate the mean-squared time error for an interval  $\tau$  for the two useful time calculation techniques discussed above, viz., linear prediction and exponential prediction. First, consider the calibration interval  $\tau_c$  with the residual rate of a clock being calculated using eq (9.15). Then using the appropriate equation for  $U_x(\tau)$  from table 9.1 and substituting these into eq (9.17) gives:

$$\begin{aligned} \langle \epsilon^2(\tau) \rangle = & \frac{h_0}{2\tau_c} (\tau_c + \tau) \cdot \tau \\ & + h_{-1} \tau^2 \left[ \frac{\tau}{\tau_c} \left( \frac{\tau_c}{\tau} + 1 \right)^2 \ln \left( \frac{\tau_c}{\tau} + 1 \right) - \left( \frac{\tau_c}{\tau} + 1 \right) \ln \left( \frac{\tau_c}{\tau} \right) \right]. \end{aligned} \quad (9.24)$$

For a given set of noise levels  $h_0$  and  $h_{-1}$  and for a particular prediction interval  $\tau$ , there is a value of  $\tau_c$  that will give a minimum for eq (9.24). Let us examine the following special cases:

$$\langle \epsilon^2(\tau) \rangle \approx \frac{h_0}{2} \tau + h_{-1} \left( 1 + \ln \left( \frac{\tau_c}{\tau} \right) \right) \tau^2, \quad \tau \ll \tau_c. \quad (9.24a)$$

$$\langle \epsilon^2(\tau) \rangle = h_0 \tau + 4h_{-1} \ln(2) \cdot \tau^2, \quad \tau = \tau_c. \quad (9.24b)$$

$$\langle \epsilon^2(\tau) \rangle \approx \frac{h_0}{2\tau_c} \tau^2 + h_{-1} \left( 1 - \ln \left( \frac{\tau_c}{\tau} \right) \right) \tau^2, \quad \tau \gg \tau_c. \quad (9.24c)$$

Note in eq (9.24a) that as the calibration interval grows even longer, the error deteriorates only very slowly for the flicker noise FM contribution (second term on right), and the error approaches a minimum (optimum) for the white noise FM contribution (first term on right). Note, in eq (9.24c) that the mean squared time error goes as  $\tau^2$  for both terms, and which one predominates depends not only on the intensity of each kind of noise ( $h_0$  and  $h_{-1}$ ), but also on the calibration interval ( $\tau_c$ ).

In figure 9.2 we have plotted the root-mean-square time error given by eq (9.24) for two atomic clocks with different levels of noise. The time fluctuations are assumed to follow the model in eqs (9.22) or (9.23), and the values for the noise intensity were chosen to nominally cover most of the commercial cesium beam clocks presently being used in the field. This illustration assumes that the deterministic terms in eq (9.7) are accounted for, and the time dispersion is due primarily to  $x(t)$  at the noise intensities indicated.

Second, for exponential prediction, consider the mean-square time error in calculating time based on eq (9.20) and assuming the same statistical model; viz., that given in eqs (9.22) or (9.23). Again taking the appropriate value of  $U_x(\tau)$  from table 9.1 and substituting into eq (9.21) gives:

$$\langle \epsilon^2(\tau) \rangle = \frac{h_0(m+1)}{2m+1} \tau + \frac{h_{-1}\tau^2}{m^2(2m+1)} \sum_{k=1}^{\infty} \left( \frac{m}{m+1} \right)^k k^2 \ln(k). \quad (9.25)$$

It is again worth noting that the value of  $m$  (the exponential frequency-weighting time constant) which gives a minimum for eq (9.25) will depend upon the level of white noise FM ( $h_0$ ) and flicker noise FM ( $h_{-1}$ ). For convenience we have tabu-

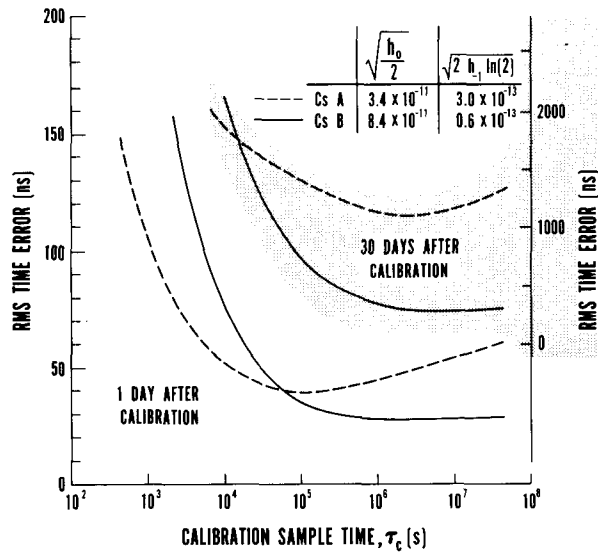

FIGURE 9.2. Root-mean-square time error of two cesium clocks as a function of calibration sample time.

lated in table 9B.1 (ann. 9.B) some useful values of the infinite sum in the second term on the right of eq (9.25). Note, as  $m$  becomes large, the first term on the right of eq (9.25) approaches the optimum.

Assuming that  $\frac{\tau_c}{\tau} = m$  in eq (9.24), it can be shown that eq (9.25) always gives at least a slightly smaller value for the error than does eq (9.24). For  $m \ll 1$ , both terms on the right of eq (9.25) become significantly less than in eq (9.24); and specifically, comparison of the terms due to white noise FM show that eq (9.24) gives a squared error which is  $1/(2m)$  larger than in eq (9.25).

A comparison of the squared error due to the flicker noise FM terms (second term on right) in eqs (9.24) and (9.25) is shown in figure 9.3.

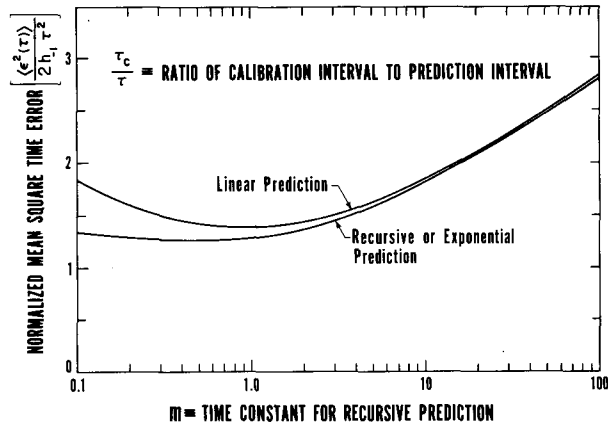

FIGURE 9.3. Comparison of mean-square time error of linear and exponential predictors for flicker noise FM.

Note, the minimums occur at  $m=1$  for the term from eq (9.24) and for  $m=0.6$  for the term from eq (9.25).

Although there may be any number of time prediction algorithms their efficiency and accuracy may be determined by applying certain tests; e.g., by processing simulated data; comparing with optimum prediction for the models assumed; and making sure that the algorithm is not highly model dependent. (In other words, the kinds of noise and the levels of noise don't have to be critically determined.) The two prediction algorithms whose frequencies are given by eqs (9.15) (linear) and (9.20) (exponential) pass these tests as long as  $m$  is approximately equal to or larger than its optimum value. They are both very easy to implement; eq (9.20) is easier to employ and is more nearly optimum. We have developed a first order time scale algorithm based in part on eq (9.20).

#### 9.4. THE AT(NBS) TIME SCALE SYSTEM

Figure 9.4 is a functional diagram of the NBS Atomic Time Scale system (AT(NBS)). The theory of operation is as follows: Block A represents a device which will accurately produce the SI second or a known fraction thereof. Block B denotes a precise measurement of the frequency ( $\nu_i$ ) or rate ( $R_i$ ) and hence of the period ( $\tau_i$ ) of each of  $n$  clocks. Block C represents a set of  $n$  independent clocks with fail-safe power supplies, where  $n$  is large enough to do individual clock characterization and to provide sufficient redundancy to guarantee that clocks will always be running. Each clock serves as an independent memory of  $\nu_0$  or  $\tau_0$ ; and together they evaluate each other. Block D denotes a precise and accurate measurement of the time differences between the clocks and indicates the mechanism for this evaluation. The time differences and the rate information are optimally used in a time scale algorithm to produce a time as shown in block E. This time is as near synchronous as possible with ideal time as discussed earlier. The time derived from the primary frequency standard, had it been running continuously at its correct (evaluated) rate, is also an approach to ideal time, but in practice there are two reasons that make this difficult to achieve. We will discuss these reasons and the functions indicated by each block in figure 9.4 in detail.

##### 9.4.1. The NBS Primary Frequency Standard and Measurement System

Historically, the primary frequency standard at NBS has been a very elaborate laboratory cesium beam device which cannot reasonably be operated continuously. In fact the decision for non-

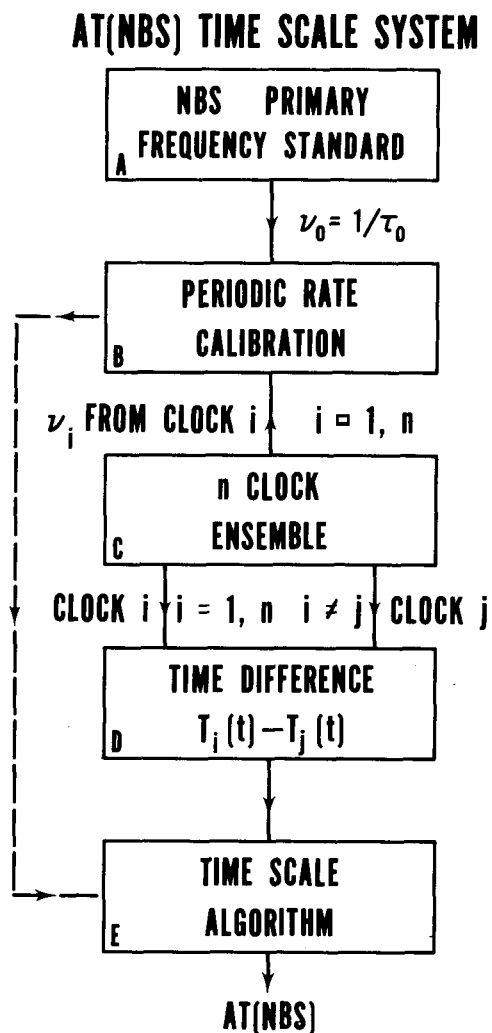

FIGURE 9.4. Block diagram of the AT(NBS) time scale system.

continuous operation was made so that we could properly evaluate all known parameters which may affect the accuracy realizing  $\nu_0$ . The last full evaluation and calibration of the NBS-III primary frequency standard (May 1969 [23]) indicated an accuracy of  $5 \times 10^{-13}$  ( $1\sigma$ ). Two new state-of-the-art primary standards have been constructed at NBS, viz., NBS-X4 and NBS-5. A preliminary



evaluation of NBS-5 has been made in late 1972 and early 1973, and the estimated frequency of NBS-III via the AT(NBS) clock ensemble is within 1 part in  $10^{13}$  ( $1\sigma$  confidence of 1 part in  $10^{12}$ ) with respect to the best estimate of frequency given by NBS-5.

NBS-X4 is still to be evaluated, and the final evaluation on NBS-5 is proceeding at the time of this writing. When the primary frequency standard is operating, a 5-MHz signal,  $\nu_0$ , is synthesized from this standard and compared with a 5-MHz source from each of the clocks in the ensemble. The prime on  $\nu_0$  in this text denotes a known frequency offset between the synthesized signal and the best estimate of a 5-MHz signal based on the primary cesium beam standard. The comparison is performed in a low noise double-balanced Schottky barrier diode mixer. The mixer provides the difference (beat) frequency ( $\Delta\nu_i = \nu_i - \nu_0$ ) between the primary standard and the  $i$ th clock. The equation for the precision of such a measurement system is given by:

$$\sigma_y(\tau) = \frac{\delta\tau_b}{\tau} \frac{\Delta\nu}{\nu}, \quad (9.26)$$

where  $\delta\tau_b$  is the precision with which the beat period ( $\tau_b = 1/\Delta\nu$ ) is known, and  $\tau$  is the time interval over which the beat signal is sampled; i.e., sample time.

The AT(NBS) rate measurement system is called a chronograph; the chronograph data, occurrence times of the zero crossings of the beat frequency ( $\Delta\nu$ ) on an arbitrary scale, are measured to a precision of  $10\mu\text{s}$ . In a typical situation we may have a value of  $\tau_b$  of 100s, which gives  $\sigma_y(\tau) \approx 2 \times 10^{-14}/\tau$  ( $T \geq 100\text{s}$ ).

A chronograph system has the theoretical potential of an extremely precise time interval device: e.g., in the above example one could measure time (phase) fluctuations between two clocks to a precision of 20 femtoseconds ( $20 \times 10^{-15}\text{s}$ ) since, from eq (9.25), we may derive:

$$\delta(\Delta t) = \frac{\delta\tau_b}{\tau_b \nu}, \quad (9.27)$$

where  $\delta(\Delta t)$  denotes the uncertainty of the change in the time (phase) difference measurement.

In practice dc drifts and component delay variations will prohibit achieving the precision given by eq (9.27). Some tests have been conducted on the chronograph which have indicated that its contribution to the instabilities of a measurement are usually negligible—consistent with eq (9.26).

#### 9.4.2. The Clock Ensemble and Time Difference System

There are currently eight commercial cesium beam frequency standards in the AT(NBS) clock

ensemble. Six of these units are located at the NBS/Boulder, CO laboratories in an environmental chamber which is controlled in temperature to better than 0.1 degree C at a nominal ambient temperature of about 23 degrees C. Each of these six units is also electrically isolated and shock mounted with an independent fail-safe power supply. The whole system is backed up with an emergency generator power source. Each of these six standards drives two frequency dividers—one from 5 MHz to 1 pulse per second (pps) and the other from 100 kHz to 1 pps. The latter divider is a redundant backup. The 5-MHz dividers are classically called “window” dividers and have pulses which are stable to subnanosecond with 6 ns rise times. The other two atomic frequency standards are at the WWV radio station near Ft. Collins, CO in a shielded and temperature controlled room. They are similarly followed by dividers from 5 MHz to 1 pps and the occurrence times of these clocks are communicated to Boulder, CO via the TV line-10 time transfer system [7, 9].

Time differences are measured to an accuracy of 2 ns and a precision of 0.5 ns with a commercial time interval counter. The time differences between one specific clock and all the others are measured automatically at the same time each day; an on-line computer is available for processing and diagnosing the data. In practice the 1 pps signal from clock  $i$  starts the counter and at a time  $\tau$  later the 1 pps signal from clock  $j$  stops the counter; this gives:

$$T_i(t) - T_j(t + \tau) = T_i(t) - T_j(t) + \tau \bar{y}_j^i(t). \quad (9.28)$$

The third term on the right of eq (9.28),  $\tau \bar{y}_j^i(t)$ , denotes  $\tau$  times the average fractional frequency offset of the  $j$ th clock over the interval from  $t$  to  $t + \tau$ . This term is usually negligible since  $\tau < 1$  s and  $\bar{y}^i(t) < 10^{-11}$ . However, caution should be used if one has a clock with a large fractional frequency offset, since this third term usually is ignored in practice.

#### 9.4.3. Atomic Time Scale Algorithms

In theory one could perform a complete characterization of both the random and the deterministic properties of each member of a set of clocks in a given ensemble. After such a characterization, favorable processors could be applied to the data to yield a theoretically optimum time scale. The obvious problem with this approach is that optimum time cannot be known during any part of the characterization interval until after all the data have been processed which may require weeks, months or years.

Another problem is—even though eqs (9.7) and (9.8) are believed to be good models for high per-

formance clock data—occasionally a change may occur in one of the coefficients, i.e.,  $D_i$ ,  $R_i(t_0)$ ,  $T_i(t_0)$ ,  $h_{0i}$ , or  $h_{-1i}$ , (e.g., the cesium getters saturate in the clock causing  $h_0$  to increase). The changes may occur discretely or gradually. Methods of detection should, therefore, be incorporated to sense such changes. One has the additional theoretical complication that a gradual change in  $T_i(t_0)$ , starting at some date  $t$ , cannot be separated from a discrete change in  $R_i(t_0)$ , at that same date; a similar situation exists for  $R_i(t_0)$  and  $D_i$  respectively. In practice, however, it is immaterial as to which assignment is made, and one is prone to choose the most convenient.

In light of the above we take the following approach for the AT(NBS) scale. With a very small sacrifice in accuracy of dating we maintain an on-line clock which constantly predicts the date that would be given by the clock ensemble (first order processed), and which is updated after each periodic ( $\sim$  once per day) ensemble processing. This first order time scale algorithm has dynamic sensing qualities; i.e., after the data are processed through a near optimum filtering routine, the algorithm senses and compensates for any changes in  $R_i(t_0)$ ,  $T_i(t_0)$ , and in the noise intensity. After a sufficient amount of data has been collected (over months or years), a second order time scale algorithm is applied to the data to give a best estimate of dating from the ensemble and primary frequency standard, and to update the coefficients for the first order algorithm. We will discuss the first order algorithm in some detail, but only some aspects of the second order algorithm as it is still being developed and tested.

a. *Clock Characterization.* In order to best estimate the deterministic coefficients (signal) for eq (9.7), we first estimate the noise characteristics so that suitable data filtering can be employed to yield near optimum signal to noise. The noise characteristics of the  $i$ th clock can be estimated by comparing it with a clock whose noise is less than its own noise over the stability region of interest (the values of  $\tau$ ). An example of this is shown in figure 9.5, where an NBS clock is compared with a Hydrogen Maser. It is highly desirable to use the "best" clock in the ensemble, and hence a different technique needs to be employed to estimate its stability. If the three clocks  $i$ ,  $j$ , and  $k$  are independent, then we may use the following as an estimate of the  $i$ th clock's stability:

$$\sigma_i^2(\tau) = \frac{1}{2} [(\sigma_{ij}^2(\tau) - \sigma_{n_{ij}}^2(\tau)) + (\sigma_{ik}^2(\tau) - \sigma_{n_{ik}}^2(\tau)) - (\sigma_{jk}^2(\tau) - \sigma_{n_{jk}}^2(\tau))], \quad (9.29)$$

where  $\sigma_{ij}^2(\tau)$ , etc., are the measured stabilities between  $i$  and  $j$ , etc., and the  $\sigma_n^2(\tau)$  are the measurement noise contributions respectively. If the

Fractional Frequency Stability (clock 2 vs. NP3)

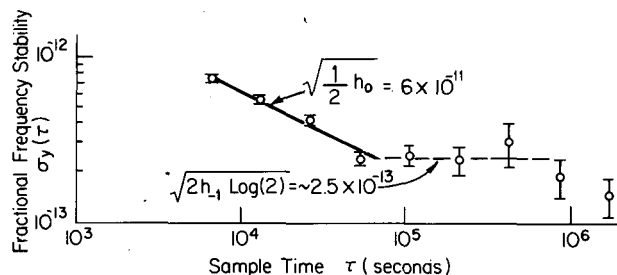

FIGURE 9.5. Hydrogen Maser (NP3), cesium beam (clock 2) comparison, showing the fractional frequency stability as a function of sample time.

measurement noise,  $\sigma_n^2(\tau)$ , is the same for each measurement pair, then eq (9.29) may be approximated by:

$$\sigma_i^2(\tau) = \frac{1}{2} [\sigma_{ij}^2(\tau) + \sigma_{ik}^2(\tau) - \sigma_{jk}^2(\tau) - \sigma_n^2(\tau)]. \quad (9.29a)$$

Of course,  $\sigma_n^2(\tau)$  needs to be measured as a separate experiment or calculated from known pertinent parameters.

Given  $n$  clocks in an ensemble there will be  $(n-1)!/(2!(n-3)!)$  different, but not all independent, estimates of  $\sigma_i^2(\tau)$ . By taking an appropriate weighted combination—recognizing that some estimates will have much better confidences than others—we get a best estimate along with the confidence of the estimate for the stability of each clock in the ensemble.

During the winter of 1969 and 1970 we had the advantage of using the National Aeronautics and Space Administration's (NASA) NP3 hydrogen maser, for study of the above method of clock stability estimation [24]. Figures 9.6 and 9.7 are  $\sigma_y(\tau)$  versus  $\tau$  plots of NBS clocks 1 and 3, which show the estimated stabilities. After the stabilities of each clock were estimated, an approximation of the ensemble stability can be made by taking the appropriate weighted combination of the stability plots for each clock. These weighting factors are discussed below. Figure 9.8 shows such a stability plot for the NBS clock ensemble. By taking the stability estimate for the clock ensemble and combining it with the stability estimate for the NP3 hydrogen maser, we compared the estimated stability of the combination with that which was actually measured. Figure 9.9 shows the excellent agreement of this comparison.

b. *Calculation of Ensemble Time.* Assume that an optimal rate,  $\hat{R}_i(t_0)$ , calibration has occurred for each clock using the clock ensemble and/or

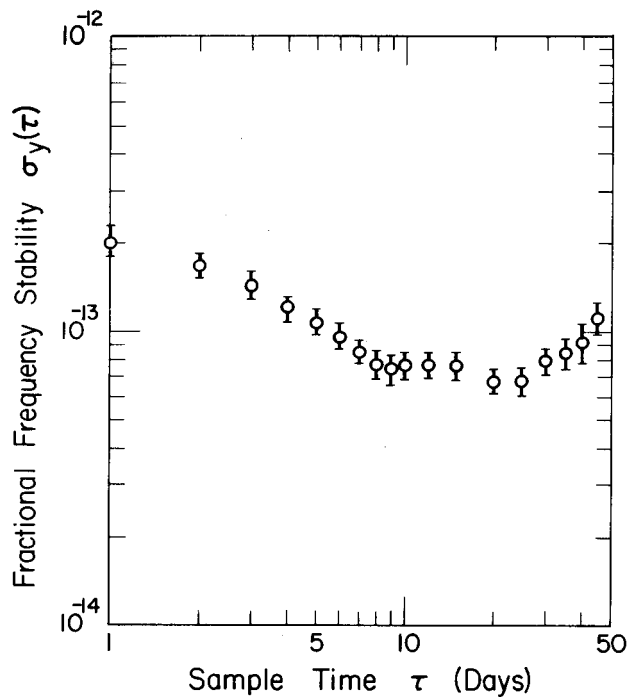

FIGURE 9.6. Fractional frequency stability of clock 1 estimated by comparison with all other clocks in the AT(NBS) clock ensemble.

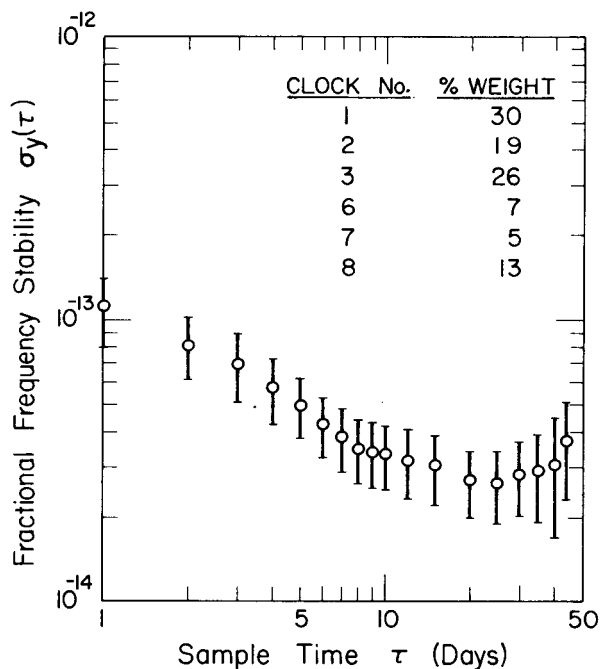

FIGURE 9.8. Fractional frequency stability of weighted 6 clock ensemble as determined from individual clock-estimates.

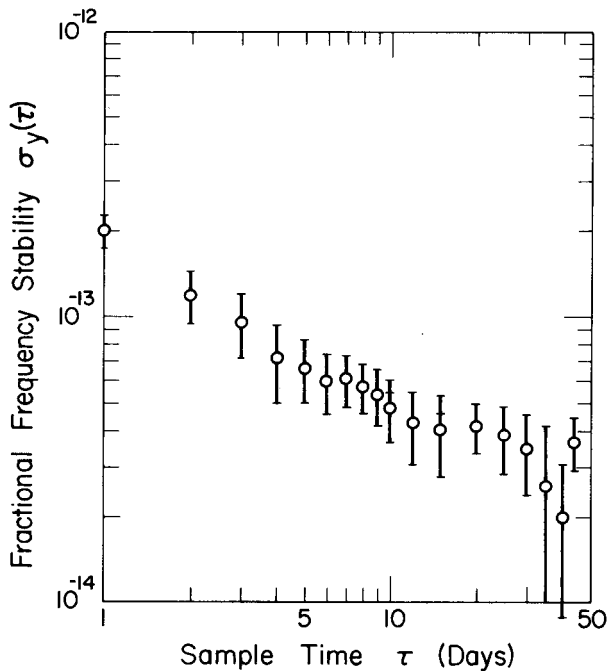

FIGURE 9.7. Fractional frequency stability of clock 3 estimated by comparison with all other clocks in the AT(NBS) clock ensemble.

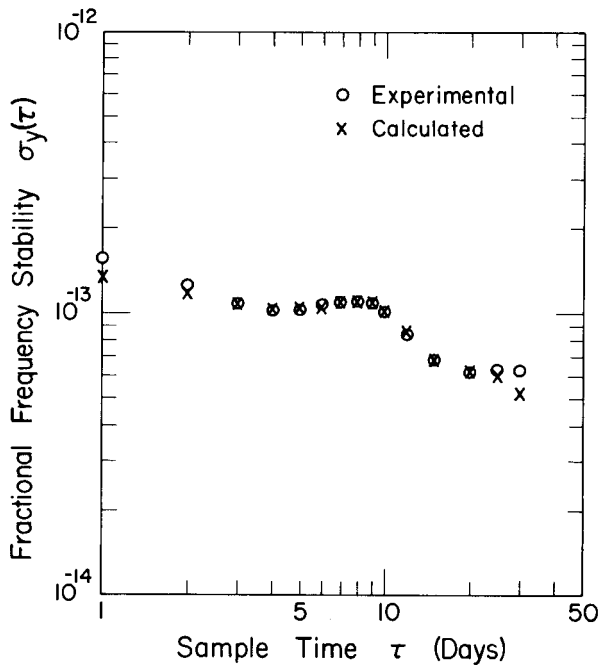

FIGURE 9.9. Hydrogen Maser (NP3) AT(NBS) clock ensemble (6 clocks) comparison showing experimental and calculated values of fractional frequency stability as a function of sample time.

the primary frequency standard, and assume further that the residual time difference between each clock and that time given by the ensemble at an agreed upon date  $t_0$  is known,  $T_i(t_0)$ . We have had insufficient data to determine the  $D_i$  coefficients which require, ideally, fairly frequent and precise calibrations with an accurate primary standard whose intrinsic reproducibility is sufficiently good so that undue noise is not added to the stability of the clock ensemble. We know the  $D_i$  coefficients are usually small, but their quadratic time dispersion rate is probably not insignificant. We will assume that they are negligible for the first order algorithm, and give proper accounting for them in the second order algorithm. For the first order algorithm, we may then optimally predict the following residual time for clock  $i$ :

$$\hat{T}_i(t_0 + \tau) = \hat{R}_i(t_0) \cdot \tau + T_i(t_0), \quad (9.30)$$

neglecting second order terms.

Now we may combine the measured time difference data,

$$T_{ij}(t_0 + \tau) \equiv T_i(t_0 + \tau) - T_j(t_0 + \tau),$$

with eq (9.30) for all the clocks to give:

$$T_j(t_0 + \tau) = \sum_{i=1}^n w_i(\tau) [\hat{T}_i(t_0 + \tau) - T_{ij}(t_0 + \tau)], \quad (9.31)$$

where the  $w_i$  are appropriate weighting factors depending upon the quality of each clock. In order to have a minimum squared error of the weighted ensemble from ideal time, it may be shown that:

$$w_i(\tau) = \frac{\langle \epsilon_i^2(\tau) \rangle}{\langle \epsilon_i^2(\tau) \rangle} \quad (9.32)$$

where  $\langle \epsilon_i^2(\tau) \rangle$  is the estimated squared error of the ensemble and is given by

$$\langle \epsilon_i^2(\tau) \rangle = \left[ \sum_{i=1}^n \frac{1}{\langle \epsilon_i^2(\tau) \rangle} \right]^{-1} \quad (9.33)$$

From eq (9.33) one can see that *all* clocks *contribute positively* to the stability of the ensemble; i.e., a poor clock does not degrade the stability. Further, the stability of the clock ensemble is better than that of the most stable clock in the ensemble.

For reasons given in the previous section we currently use an exponential prediction routine in our first order algorithm. Therefore, we may calculate the mean-squared clock error using eq (9.25)—having estimated the noise characteristics using eq (9.29). We may also experimentally esti-

mate the time dispersion of a clock if we have several time measurements with respect to the ensemble over equally spaced intervals. A bias is introduced when measuring a clock's time against the time of the ensemble of which it is a member since it would not, then, be statistically independent. An estimate of the unbiased error of the  $j$ th clock accumulated over the interval  $\tau$  is given by:

$$|\epsilon_j(\tau)| = |\hat{T}_j(t_0 + \tau) - T_j(t_0 + \tau)| + \frac{0.8 \langle \epsilon_j^2(\tau) \rangle}{\langle \epsilon_i^2(\tau) \rangle^{1/2}}, \quad (9.34)$$

where the 0.8 arises from the assumption of a normal distribution of errors. The average square of eq (9.34) then gives an experimental estimate of eq (9.25). We have tested both methods of clock error estimation and obtained reasonable agreement between them.

Equation (9.31) gives the time of the  $j$ th clock with respect to ideal time, estimated by a procedure which minimizes the squared error; hence a working clock can be made to read "correctly" by adjusting its tick to be  $T_j(t_0 + \tau)$  later than that of the  $j$ th clock. Once the residual time of each clock has been calculated, we have in effect a new origin and in general we may replace  $t_0$  by  $t$  in eqs (9.30) and (9.31). Generalizing these latter two equations for any time  $t$ , one has the advantage of both sensing and accounting for the previously mentioned dynamic changes in a clock's characterization.

All that is required to confidently sense rate changes or time jumps in a clock is a stable reference. Since the primary frequency standard is not continuously available, we simply use the clock ensemble, which in principle is better than the best clock in the ensemble, as our stable reference between calibrations. Equation (9.20) is used as a near optimal update for the rate  $\hat{R}_i(t)$  of each clock. Figure 9.10 shows the rates (converted to fractional frequency,  $y_i(t)$ ) for some of the clocks composing the AT(NBS) scale ensemble. These rates were determined with respect to the ensemble, not the primary standard. The ordinate was arbitrarily and conveniently chosen for each clock. Annex C gives a computer program written for a mini-computer, covering some aspects of our first order time scale algorithm which generated the rates shown in figure 9.10.

Whereas the weighting factors which give a minimum mean squared time error are given by eq (9.32), the time constant  $m_i\tau$  ( $m$  as in eq (9.20)), coupled with  $w_i$  determine the weighting factors which give the near optimum frequency stability for the clock ensemble. A classic illustration of the above weightings is a quartz crystal clock as compared to a commercial cesium beam clock (see fig. 9.1). If the interval  $\tau$  between time interval measurements were short (a few seconds) then a

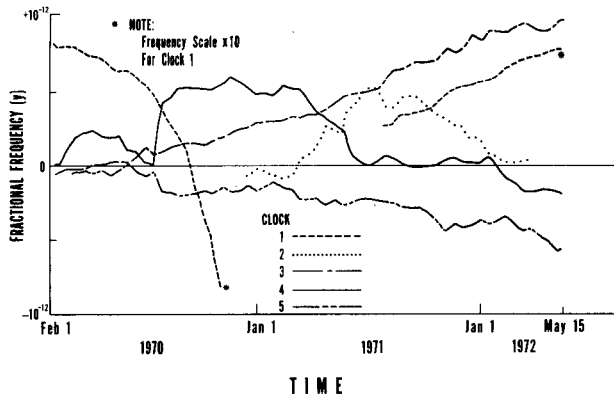

FIGURE 9.10. Relative fractional frequencies of five selected cesium clocks in the AT(NBS) scale as a function of time with the AT(NBS) scale used as the reference (note the arbitrary origin).

larger weight would be given to the quartz crystal clock (per eq (9.32)) than to the commercial cesium clock—yielding a very stable time scale in short-term. However, in long-term the superior frequency stability of the atomic clock shows an optimum value of  $m$  much larger than for the quartz crystal clock and yields a very stable time scale, as the composite rate would be determined by the commercial cesium beam clock.

For the above particular exponential time prediction algorithm, we have conducted tests to see how variations in the value of  $\tau$  (the interval between time difference measurements) affects the overall stability characteristics of the ensemble. A small effect was observed; e.g., increasing  $\tau$  by about a factor of 10 improved the long-term stability by a few percent. This is a direct indication that this particular algorithm is only near optimum. For practical applications, however, where clocks can only be characterized to confidences of a few percent, the ease of implementation of this exponential prediction routine has proved to be efficient and adequate for our first order time scale algorithm. The value of  $\tau$  can be chosen pretty much for the convenience of data acquisition and analysis without any significant degradation of the time scale stability.

We currently measure the time differences between the clocks each day; such measurements are done automatically in our time scale automation system. Figure 9.11 is a plot of the accumulated time errors summed from the errors determined after each day's measurement for the more important clocks in the NBS clock ensemble. Currently for  $\tau = 1$  day the experimental ensemble error given by eq (9.33) is about 5 ns. If we may assume that the ensemble stability plot shown in figure 9.8 is representative for longer values of  $\tau$ , then we can use eq (9.25) to estimate the time dispersion of the clock

ensemble for the 2 years and 3 months period shown for some of the individual clocks in figure 9.11. Assuming  $m\tau$  for the clock ensemble is about 8 days, we derive a time dispersion for the clock ensemble of about  $4\mu\text{s}$ , which appears conservative in comparison with the time dispersion of the individual clocks. Note, that this is the time dispersion due to the random error predominantly, and does not account for non-random dispersion such as may be caused by steps and drifts in frequency.

c. *Rate Accuracy of AT(NBS) Scale.* Ultimately the accuracy of the rate of an atomic time scale must depend upon the accuracy of one or more evaluable primary frequency (rate) standards. In our case a primary reference was NBS - III in the past, and is now NBS - 5 and NBS - X4. The primary function of a clock ensemble as regards rate accuracy is to serve as a memory of past calibrations. The better the clock ensemble stability the more nearly perfect the memory of the proper rate given by a primary standard from which the clock ensemble derives its accuracy.

In any given evaluation of a primary rate standard there are associated inaccuracies. Each of these inaccuracies arises from the uncertainty in knowing how much a particular parameter biases the frequency of the primary standard. It is convenient to categorize these bias uncertainties: first are those uncertainties  $\sigma_{\text{ruc}}(l)$ , which will be random and uncorrelated in their inaccuracy contribution from one evaluation to the next; second are those which are otherwise,  $\sigma_b(l)$ ; these are typically constant for a given device. The overall accuracy may then be written for the  $l$ th evaluation:

$$\sigma(l) = [\sigma_{\text{ruc}}^2(l) + \sigma_b^2(l)]^{1/2} \quad (9.35)$$

If we had a time scale with perfect memory the first inaccuracy contribution would average as the square root of the number of calibrations. In such a

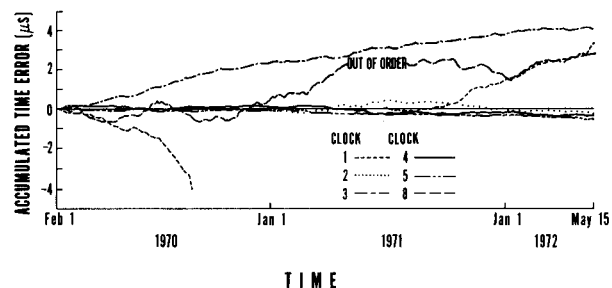

FIGURE 9.11. Long-term accumulated time errors of 6 selected cesium clocks in the AT(NBS) time scale.

case we could have a time scale with an accuracy of rate better than that from a single evaluation of the primary standard, given a sufficient number of calibrations. In practice, of course, there is some frequency dispersion in the time scale memory as well as the possibility of some deterministic drifts,  $D_i \neq 0$  (see fig. 9.10). Assuming that the deterministic aspects such as  $D_i$  can be properly accounted for in the second order time scale algorithm and assuming that each calibration is optimally weighted, we may then write the following for the squared accuracy of the calibrated clock ensemble,  $\sigma_e^2(l)$ , after the  $l$ th calibration:

$$\sigma_e^2(l) = \sigma_b^2(l) + \left[ \frac{1}{\sigma_{\text{ruc}}^2(l)} + \frac{1}{\langle \sigma_{y_e}^2(2, T, \tau, f_h) \rangle + \sigma_e^2(l-1) - \sigma_b^2(l-1)} \right]^{-1}, \quad (9.36)$$

where  $\langle \sigma_{y_e}^2(2, T, \tau, f_h) \rangle$  is the clock ensemble frequency stability (see eq (9.9); ( $T$  is the time from the beginning of one calibration to the next, and  $\tau$  is the calibration sample time). We have also implicitly assumed that the same primary standard is employed and that  $\sigma_b^2(l)$  remains the same or improves with experience. If either or both of these assumptions are not true, one can improve on eq (9.36) through techniques to be published in the future.

From eq (9.36), we see that with an adequately stable clock ensemble, the accuracy of the clock ensemble approaches that of  $\sigma_b(l)$ . In the case of AT(NBS) the last calibration was May 1969, and  $\sigma_e^2(l-1)$  was  $5 \times 10^{-13}$  [23]. Our first preliminary calibration of AT(NBS) with NBS-5 occurred over the period 13-22 January 1973 with preparatory measurements being made during November and December of 1972. This calibration measured AT(NBS) too high in rate by 6.9 parts in  $10^{13}$ . The use of eq (9.36) and weighting of the two above mentioned calibrations inversely proportional to their accuracies indicated that we should decrease the rate of AT(NBS) by 4.5 parts in  $10^{13}$ ; this change was made at 0000 hours AT on 1 February 1973. Between 27 January 1973 and 6 April 1973 we performed four more preliminary calibrations, and again the application of eq (9.36) for each of these indicated that we should increase the rate of AT(NBS) by 5.1 parts in  $10^{13}$ .

These experimental results give direct evidence for the second reason we believe it is not best to use a primary frequency standard as a clock; i.e., the biases which need to be taken into account in order to obtain an accurate frequency estimate are not always constant from one calibration to the next. Hence, if the clock ensemble is more stable than the changes in these biases, an appropriate filter may be applied to the calibration values so that both

accuracy and stability are preserved for the atomic time scale. Incorporating this philosophy we increased the rate of AT(NBS) by 0.5 parts in  $10^{13}$ —a frequency step which is the order of the time scales frequency instability—at 0000 hours AT, 1 May 1973. The frequency of these steps will be kept small enough so that they are essentially masked by the long-term dispersion of the clock ensemble.

At this writing the accuracy rate of AT(NBS) using eq (9.36) is 5.2 parts in  $10^{13}$ ,  $\sigma_b(l)$  is estimated at about 5 parts in  $10^{13}$ , and the best estimate of the rate of AT(NBS) is too low by 4.6 parts in  $10^{13}$  with respect to NBS-5.

## 9.5. THE UTC(NBS) COORDINATED SCALE

The atomic time scale AT(NBS) is an independent and proper<sup>4</sup> time scale. The readings of any two such scales will have a comparative dispersion for two fundamental reasons: first, from deterministic differences; and second, from the random noise inherent in any time scale system. The first reason for dispersion may be caused by differences in accounting for the biases affecting the primary frequency standards of each scale; these differences should fall within the ascertained accuracy limits. Or it may be caused by the difference in gravitational potential at which the two scales are running ( $-gH/c^2$ ;  $H$  is the differential height). The second reason for dispersion may be caused by fundamental noise processes in the clocks and/or by noise inserted by the measurement system or while the data are being processed in a particular time scale algorithm; i.e., different algorithms will have different amounts of dispersion.

Because of the above mentioned dispersion, if two different time scales are to be kept synchronized, it becomes necessary to insert a rate and a time correction in one or the other or in both time scales. Starting on 1 October 1968 a mutual coordination agreement was made with the United States Naval Observatory (USNO) to keep the UTC(USNO) and UTC(NBS) scales synchronized to within about 5  $\mu$ s by making equal and opposite coordinated rate corrections [25].

More recently the philosophy that NBS has adopted is to generate a nonindependent coordinated time scale UTC(NBS) which is kept synchronous with the internationally adopted time scale maintained at the Bureau International de l'Heure (BIH)—denoted UTC [6]. This is accomplished as indicated in figure 9.12 with slight rate and leap second additions to AT(NBS). The constant  $C$  was chosen so that at 00 h 00 min 00 s UTC on 1 January 1972 the UTC(NBS) scale was synchronous to within about 3  $\mu$ s of UTC. Because of similar direc-

<sup>4</sup> Proper is here used in the relativistic sense.

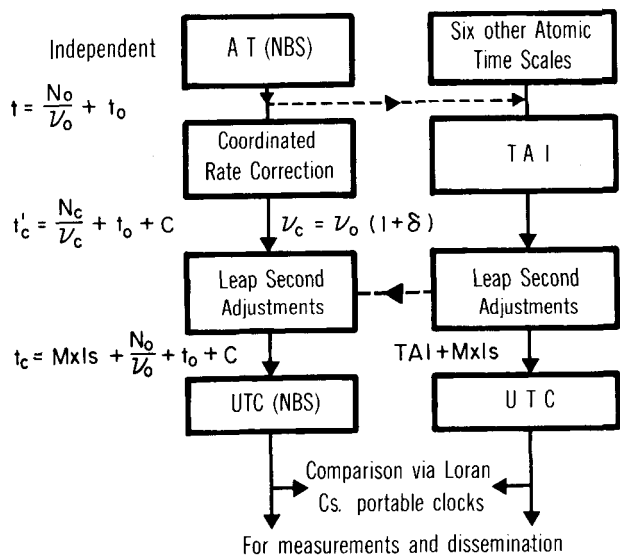

FIGURE 9.12. Block diagram showing the derivation of UTC(NBS) from AT(NBS) and its coordinated relationship to UTC(TAI).

tions taken by the USNO to keep their UTC(USNO) scale synchronized to UTC after 1 January 1972 the above agreement to keep nominal synchronization will continue to be maintained to within a few microseconds.

The insertion of leap second adjustments is determined by the BIH following CCIR regulations [25]. The insertion usually occurs on 30 June and/or 31 December for the purpose of keeping the time difference  $|UTC - UT1|$  nominally less than 0.7s. M was set to minus 10 on 1 January 1972, minus 11 on 30 June 1972, minus 12 on 31 December 1972, and minus 13 on 31 December 1973.

The equation relating AT(NBS) and UTC(NBS) as of 1 May 1973 is given by:

$$AT(NBS) - UTC(NBS) = 12.045153000s - (129.6 \text{ ns/day}) \cdot (MJD - 41803 \text{ days}), \quad (9.37)$$

where MJD is the Modified Julian Day number. Equation (9.37) does not account for second order terms; i.e., atomic days are not used. (Recent investigations indicate that we need to define an Atomic Julian Day count or its modified equivalent for consistency so that eq (9.37) can be made exact.) It is anticipated that the  $\delta_{NBS}$  coordinate rate corrections will be made on 1 January of each year in order to keep the time difference  $|UTC - UTC(NBS)|$  as small as practicable while also maintaining close coordination with UTC(USNO).

## 9.6. UTC(NBS) ACCESSIBILITY

The determination of a date on the AT(NBS) scale or on the coordinated UTC(NBS) scale requires some method of accessibility. Figure 9.13 gives a fractional frequency stability,  $\sigma_y(\tau)$  versus  $\tau$  plot for the main methods of communicating the time and/or frequency of these two scales. The stability data for figure 9.13 were taken from references [9, 26-29] or were measured and computed by the authors. Typically, the UTC(NBS) scale is the one disseminated and eq (9.37) or its updated version, which is published in reference [30], is required to compute AT(NBS). For comparison purposes the estimated stability of AT(NBS), which will be essentially the same as the stability for UTC(NBS), and the calculated and measured stability of NBS-X4 and of NBS-5 respectively are also plotted in figure 9.13. It is anticipated that the stability of NBS-5 will improve from further advancements in both its electronic servo system and its beam optics.

The date on the UTC(NBS) scale is communicated from NBS/Boulder, CO to the NBS radio stations (WWV, WWVB, and WWVL) near Ft. Collins, CO via the TV line-10 time transfer system [7, 9, 11]. Notice the excess noise (day to day) on the accumulated time error plot for clock 8 in figure 9.11. This is one of the three cesium clocks at WWV which is used in the AT(NBS) clock ensemble. This excess noise is in the TV line-10 time transfer system and amounts to  $\langle \sigma_x^2(2, T=1d, \tau=1/f_h, f_h) \rangle^{1/2} \approx 30 \text{ ns}$ . Time and/or frequency are communicated to WWVH at Kekaha, Kauai, Hawaii via WWVB transmissions and portable clocks.

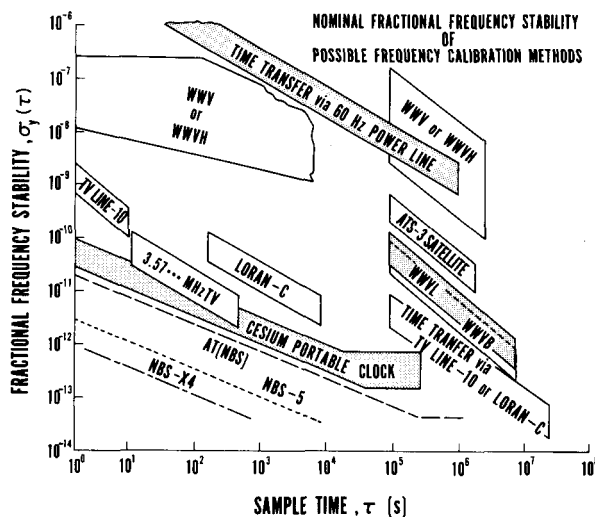

FIGURE 9.13. Fractional frequency stability as a function of sample time for several UTC(NBS) dissemination techniques.

Note that the signals from Loran-C, 60-Hz power line, as well as TV line-10 need to be used in the time transfer mode; i.e., the date of arrival of the signal on the UTC(NBS) scale must be differenced with the date of arrival of the signal ascertained with the user's clock in order to determine if a change has occurred in the user's clock time since the last measurement. In the case of the latter two the path delay has to be calibrated for time transfer (not frequency transfer), e.g., with a portable clock.

The following relationship allows the conversion from the fractional frequency stability to the time stability for most of the methods shown in figure 9.13 (see ref. [18]):

$$\langle \sigma_x^2(2, T, \tau_x, f_h) \rangle^{1/2} = \frac{\tau}{\sqrt{4 - 2^{\mu+2}}} \sigma_y(\tau), \quad (9.38)$$

where  $2 < \mu < 0$ ,  $T = \tau$ ,  $\tau_x \ll T$ , and it will be remembered that  $\sigma_y(\tau) \sim \tau^{\mu/2}$ . Applying eq (9.38) to the long-term stability data for Loran-C and TV line-10 as an example yields  $\sim 2.5 \text{ ns } \tau^{1/3} \text{ s}^{-1/3}$  over the range  $1 \text{ day} \leq \tau \leq 100 \text{ days}$ .

Table 9.2 has been compiled to show characteristics of methods of obtaining data on the UTC(NBS) scale. There are additional factors that need to be considered from the users point of view such as reliability, greater skill required, and number of users that can be served (see chap. 10, sec. 10.6 or ref. [26]). In addition to the techniques listed in table 9.2, personnel at NBS/Boulder, CO also monitor other radio stations (NAA, GBR, NLK), and these may be used in the time transfer mode to communicate UTC(NBS) date as the readings are published monthly [30].

The users' cost effectiveness for the precision and accuracy achieved by the techniques of TV line-10 and the ATS-3 satellite, respectively, is very good. Insertion of an active time code on a line in the blanking interval of the TV transmissions has been experimentally tested [31, 32] and the method has the potential of being extremely cost effective for the excellent precisions ( $< 1 \mu\text{s}$ ) achievable; in addition, it shows accuracy of maintaining the date once the path has been calibrated. The ATS-3 date transfer method was experimental and terminated

TABLE 9.2. UTC(NBS) Accessibility

Method of access	Coverage	Times available	Nominal accuracy for date transfer	Additional equipment cost to user
WWV and WWVH.....	hemisphere.....	continuously.....	$\leq 1 \text{ ms}$ .....	$\sim$ \$200 to \$2,000.
WWVB.....	North America.....	continuously.....	$\sim 50 \mu\text{s}$ .....	$\sim$ \$400 to \$4,000.
WWVL.....	global.....	experimental.....	envelope $\sim 500 \mu\text{s}$ ...	$\sim$ \$4,000.
ATS-3 Satellite.....	hemisphere.....	experimental 1700 to 1715 UTC 2300 to 2345 UTC daily (terminated late 1973).	10 to 50 $\mu\text{s}$ .....	$\sim$ \$150.
Telephone (303) 499-7111.....	North America.....	continuously.....	$\leq 0.03 \text{ s}$ .....	price of phone calls.
Portable Cs. Clock.....	global.....	per user's desire.....	$\sim 0.1 \mu\text{s}$ .....	$\sim$ \$19,000.
Portable Rb. Clock.....	global.....	per user's desire.....	$\sim 1 \mu\text{s}$ .....	$\sim$ \$12,000.
Loran-C (ground wave).....	east of Rocky Mtns. (N. Am.), through Europe.	1500 UTC each work day.	$\leq 3 \mu\text{s}$ .....	$\sim$ \$5,000 to \$10,000.
Line-10 Television.....	requires common reception of east USA network programs.	$\sim$ 1330 local time (Boulder) each work day.	need to calibrate path; precision $\sim 1 \text{ ns } \tau^{1/2} \tau > 33 \text{ ms}$	$\sim$ \$100 to \$500.
60-Hz Power Line.....	USA and some adjacent areas. (Verified between CO and CA.)	proposed.....	need to calibrate path; precision $\leq 1 \text{ ms } \tau_0 17 \text{ ms}$ $\leq \tau \leq 10^5 \text{ s}$ .	$\sim$ \$10 to \$100.
Omega Navigation System.....	global.....	proposed.....	$< 10 \mu\text{s}$ .....	$\sim$ \$16,000.



late 1973; however, the tests have proven successful [12]. There are plans for an NBS experiment which would provide time from UTC-(NBS) continuously, using a Department of Commerce satellite.

The direct signal from the 60-Hz power line is not very stable;  $\sigma_y(\tau) \approx 5 \times 10^{-5}$  for  $17 \text{ ms} \leq \tau \leq 10^5 \text{ s}$ . However, the stability of the differential delay between two points has much greater stability. The 60-Hz power line stability data shown in figure 9.13 represent the differential path delay between Santa Clara, CA and Boulder, CO. A similar study was performed for the path between Ft. Collins, CO and Boulder, CO, and the stability was about 5 times better. This very inexpensive time transfer system has significant potential for users needing synchronization to about 1 ms [33].

An exotic time and frequency dissemination system of the future with a potential of nanosecond precision and accuracy of date transfer may employ a belt of geostationary satellites around the globe. Each satellite may have an rf communications transponder and a triggerable infrared pulsed laser radiating the earth. Using trilateration with a grid of synchronous ground station clocks the position of the satellite could be determined to a few centimeters, and thence communicated, along with the dates of occurrence of the laser's pulses, to the appropriate receiving equipment. The infrared seems desirable because of available bandwidth, accurately calculable path delay, less problems with cloud cover than with the visible, and some comparative cost considerations.

## 9.7. THE INTERNATIONAL ATOMIC TIME SCALE (TAI)

The TAI scale is constructed at the BIH using the input via Loran-C and TV time transfer techniques of several cesium standards located in many of the time and frequency laboratories throughout the world—including the standards used to generate AT(NBS) (see fig. 9.12). There is reason to believe that the TAI is stable to about  $1 \times 10^{-13}$  for  $\sigma_y$  ( $\tau \sim 1 \text{ year}$ ) and is probably the most stable reference time scale available [3], hence its use as a reference may provide reasonable comparisons among the primary frequency standards of these laboratories. The fractional frequency of TAI with respect to four of the evaluable primary frequency standards in the world are as follows: for PTB (Germany), CS1 [ $+ 12 \pm 4 (1\sigma) \times 10^{-13}$ , March–July 1970 [34]; for NRC, Cs III [ $+ 8 \pm 15 (2\sigma) \times 10^{-13}$ , July 2–November 9, 1970 [2, 35]; for NBS, NBS-III [ $+ 10 \pm 5 (1\sigma) \times 10^{-13}$ ,<sup>5</sup> May 1969 [23], and NBS-5 [ $+ 12 \pm 5 (1\sigma) \times 10^{-13}$ ,<sup>5</sup> January–April 1973 [36].

<sup>5</sup>These values account for  $\sim 1.8$  parts in  $10^{13}$  gravitational red shift due to the elevation of Boulder, Colorado.

AT(NBS) was in rate agreement to within  $1 \times 10^{-13}$  of the NBS primary frequency standard NBS-III in May 1969. Since that date NBS-III has been disassembled; parts were used in the construction of NBS-5. The rate of TAI with respect to AT(NBS) as of January 1, 1973 was about  $+11 \times 10^{-13}$  via Loran-C [37]. If TAI were perfect the preceding would imply a decrease in the rate of AT(NBS) of about  $\sim 2 \times 10^{-13}$  in approximately 4 years.

Such a rate drift singularly considered would cause a time dispersion of about  $25 \mu\text{s}$  over this same period. However, if in eq (9.7)  $D_{\text{AT(NBS)}}$  is assumed zero and  $R_{\text{AT(NBS)}}$  is  $-75 \text{ ns/day}$  as was estimated in 1969 by Dr. Guinot (The Director of the BIH), then the calculated value using eq (9.7) differs only by about  $5 \mu\text{s}$  from that measured over the same 4 years. (Note: AT(NBS) is not totally independent of TAI.)

In the past the primary consideration for the TAI has been uniformity, with accuracy of secondary importance. With the adoption of TAI scale by the 14th General Conference of Weights and Measures (CGPM) in 1971 [38], conforming to the definition of the SI second, there is added emphasis upon accuracy. A recent study by the BIH has shown that the TAI scale has a 50 percent probability of an annual frequency drift of about  $[0.5 \times 10^{-13}]$  [5]. "Except through the participation of NRC the scale unit of TAI is not anchored to the Système International d'Unites (SI) second and may diverge indefinitely from it. Recalibration is necessary." [5] There is a general awareness of this problem, and recommendations have been made by Dr. Guinot and others for reasonable corrective procedures (see sec. 1.5 of chap. 1) [39, 5]. Principally, the BIH is seeking individual clock data in place of a constructed time scale of an individual laboratory; this obviates some errors from individual clock and/or time scale equipment failures, as well as differences in method of calculating the individual laboratory time,  $\text{TA}(i)$ , used in the construction of TAI. Dr. Guinot also recommends frequent comparison of the TAI second with that generated by evaluable primary frequency standards. After initial calibration, it will probably be necessary to make a frequency adjustment to the TAI scale and thereafter apply an intentional frequency drift ( $\sim \pm 1.0 \times 10^{-13}/\text{year}$ ) so that TAI agrees with evaluations of the SI second [5]. It is hoped that many of the concepts and algorithms developed in this chapter may be of help to the BIH staff in their important task of constructing a TAI scale in conformance with the SI unit of time.

## 9.8. CONCLUSIONS

The rate of the AT(NBS) (proper) scale serves as a memory of the rate of the NBS primary frequency standard. The stability of the statistically weighted eight clock ensemble making up AT(NBS) deter-

mines the quality of the memory. The random fractional frequency fluctuations have been estimated and are reasonably modeled by:

$$\sigma_{y_e}^2(\tau) = (5 \times 10^{-12})^2 \tau^{-1} + (3 \times 10^{-14})^2, \quad (9.39)$$

where  $1 \text{ s} \leq \tau \leq 10^7 \text{ s}$ . Some relative frequency drift has been observed between the members of the commercial cesium beam frequency standards composing the clock ensemble, and an estimate of the possible drift of the ensemble indicates that it should be  $|D_e| \leq 2 \times 10^{-13}$  per year. The accuracy ( $1\sigma$ ) of the rate of AT(NBS) is currently estimated to be  $5.2 \times 10^{-13}$ .

The method employed for generating the AT(NBS) scale is based on a particular clock model. This model assumes that a linear frequency drift, a frequency offset, a time offset, and random noise can all perturb the time of a clock. A convenient recursive filter has been employed to process the data in a near optimum way, and to properly filter the perturbations introduced by all but the frequency drift; this drift can be measured over a sustained period with a primary frequency standard and can then be properly taken into account.

The UTC(NBS) scale differs in rate from the independent AT(NBS) scale by coordinated rate corrections; such corrections keep UTC(NBS) in nominal synchronization (to within a few  $\mu\text{s}$ ) with UTC (the international Coordinated Universal Time scale maintained at the BIH). The clocks composing the AT(NBS) scale provide some of the input data for the time scale algorithm which generates TAI (UTC is kept within about 0.7 s of the UT1 scale by making leap second adjustments of UTC with respect to TAI).

Time and frequency are accessible from the UTC(NBS) scale via sundry dissemination and time communication methods; e.g., HF and LF radio (WWV, WWVH, WWVB, WWVL), telephone, portable clocks, Loran-C, line-10 TV and network TV color subcarrier frequency. These differ in accuracy of date transfer from  $\sim 50 \text{ ms}$  to a few nanoseconds, and in the precision of a frequency calibration from parts in  $10^7$  to a few parts in  $10^{14}$ . Nominally, the quality of precision is commensurate with equipment cost; i.e., higher precision requires increased equipment cost to the user. (TV and some satellite methods give the minimum cost per precision and accuracy achievable.)

The fractional frequencies of the TAI have been determined with respect to four of the world's evaluable primary frequency standards. TAI is probably the most stable time scale in the world with a stability of about  $1 \times 10^{-13}$  for  $\sigma_y(\tau \sim 1 \text{ year})$  [3]; it has been reported that this scale shows frequency drifting of some  $|0.5 \times 10^{-13}|$  per year [5]. The BIH is proposing several solutions for improving this free running scale and making it more nearly in agreement with the SI unit of time. Some of the techniques discussed in the chapter could aid

conceivably in the evaluation and construction of the TAI. Possible means for comparing time scales include portable clocks [9], aircraft flyover [40], satellite/television techniques [41], and Loran-C [9].

AT(NBS) was in rate agreement to within  $1 \times 10^{-13}$  of NBS-III in May 1969. The rate of TAI with respect to AT(NBS) as of January 1973 was about  $11 \times 10^{-13}$  via Loran-C. If TAI were perfect this implies a decrease in the rate of AT(NBS) of  $\sim 2 \times 10^{-13}$  over approximately 4 years; this is well within the uncertainties internally assigned to the AT(NBS) system. The accuracy goal for NBS-5 is  $1 \times 10^{-13}$ . Attainment of this goal obviously will allow a significant improvement in the accuracy of the AT(NBS) rate. A preliminary calibration with NBS-5 of AT(NBS) was made during January-April 1973; the rate measured for AT(NBS) was within  $1 \times 10^{-13}$  of NBS-5's rate. As of March 1973, TAI appeared to be too high in rate by  $12 \times 10^{-13} \pm 5 \times 10^{-13}$  (the current accuracy estimate for AT(NBS) and NBS-5) with respect to NBS-5 and via a filtered estimate using Loran-C data as a time transfer mechanism.

## 9.9. REFERENCES

- [1] Winkler, G. M. R., Hall, R. G., and Percival, D. B., "The U.S. Naval Observatory clock time reference and the performance of a sample of atomic clocks," *Metrologia*, **6**, No. 4, pp. 126-134 (October 1970).
- [2] Mungall, A. G., "Atomic time scales," *Metrologia*, **7**, No. 4, pp. 146-153 (October 1971).
- [3] Allan, D. W., "Statistical modeling and filtering for optimum atomic time scale generation," *Proc. Frequency Standards and Metrology Seminar* (Quebec, Canada, August 30, 31-September 1, 1971) H. Hellwig (Ed.), pp. 388-410 (Dept. Elec. Eng., Laval Univ., Quebec, Canada, June 1972).
- [4] Yoshimura, K., "The generation of an accurate and uniform time scale with calibrations and prediction," *Nat. Bur. Stand. (U.S.) Tech. Note 626*, 64 pages (USGPO, November 1972).
- [5] Guinot, B. and Granveaud, M., "Atomic time scales," *IEEE Trans. on Instrum. and Meas.*, **IM-21**, No. 4, pp. 396-400 (November 1972).
- [6] CCIR, "Detailed instructions by Study Group 7 for the implementation of Recommendation 460 concerning the improved coordinated universal time (UTC) system, valid from 1 January 1972," in *XIIth Plenary Assembly CCIR* (New Delhi, India, 1970), **III**, pp. 258a-d (ITU: Geneva, Switzerland, 1970) (see chap. 1-ann. 1.B.2).
- [7] Milton, J. B., "Standard time and frequency: its generation, control, and dissemination from the National Bureau of Standards Time and Frequency Division," *Nat. Bur. Stand. (U.S.) Tech. Note 379*, 27 pages, (USGPO, August 1969) (see future updates).
- [8] Viezbicke, P. P. (Ed.), "NBS frequency and time broadcast services, radio stations WWV, WWVH, WWVB, WWVL," *Nat. Bur. Stand. (U.S.) Misc. Pub. 236*, 19 pages (USGPO, May 1973). Note: A new edition is published annually.
- [9] Allan, D. W., Blair, B. E., Davis, D. D. and Machlan, H. E., "Precision and accuracy of remote synchronization via network television broadcasts, Loran-C and portable clocks," *Metrologia*, **8**, No. 2, pp. 64-72 (April 1972).
- [10] Davis, D. D., "Frequency standard hides in every color set," *Electronics*, **44**, No. 10, pp. 96-98 (May 10, 1971).
- [11] Davis, D. D., Blair, B. E., and Barnaba, J. F., "Long term continental U.S. timing system via television network," *IEEE Spectrum*, **8**, No. 8, pp. 41-52 (August 1971).

- [12] Hanson, D. W., Hamilton, W. F., and Gatterer, L. E., "The NBS frequency and time satellite experiment using ATS-3, *Proc. 3rd Ann. Precise Time and Time Interval (PTTI) Strategic Planning Meeting* (Washington, DC 20390, November 16-18, 1971), pp. 155-165 (USNO, Washington, DC 20390, January 1972). (NTIS, AD 758739)
- [13] CGPM, *Comptes Rendus des Séances de la Treizième Conférence Générale des Poids et Mesures* (Proceedings of the Sessions of the 13th General Conference of Weights and Measures) (Paris, France, October 1968), p. 103 (Gauthier-Villars, Paris, France 1968) (in French—see chap. 1-ann. 1.A.1.).
- [14] Hellwig, H., "Frequency standards and clocks: a tutorial introduction," *Nat. Bur. Stand. (U.S.) Tech. Note 616*, 69 pages (USGPO, April 1972).
- [15] Allan, D. W., "Statistics of atomic frequency standards," *Proc. IEEE*, **54**, No. 2, pp. 221-230 (February 1966).
- [16] Barnes, J. A., Chi, A. R., Cutler, L. S., Healey, D. J., Leeson, D. B., McGunigal, T. E., Mullen, J. A., Jr., Smith, W. L., Snyder, R., Vessot, R. F. C., and Winkler, G. M. R., "Characterization of frequency stability," *IEEE Trans. on Instrum. and Meas.*, **IM-20**, No. 2, pp. 105-120 (May 1971) (see chap. 8).
- [17] Barnes, J. A., "Tables of bias functions,  $B_1$  and  $B_2$ , for variances based on finite samples of processes with power law spectral densities," *Nat. Bur. Stand. (U.S.) Tech. Note 375*, 37 pages (USGPO, January 1969) (see chap. 8).
- [18] Barnes, J. A., "Atomic timekeeping and the statistics of precision signal generators," *Proc. IEEE*, **54**, No. 2, pp. 207-220 (February 1966).
- [19] Vessot, R. F. C., Mueller, L. F., and Vanier, J., "The specification of oscillator characteristics from measurements made in the frequency domain," *Proc. IEEE*, **54**, No. 2, pp. 199-207 (February 1966).
- [20] Barnes, J. A. and Allan, D. W., "A statistical model of flicker noise," *Proc. IEEE*, **54**, No. 2, pp. 176-178 (February 1966).
- [21] Becker, G., "Mathematische Filterung von Messwerten; Anwendungen im Bereich von Zeit und Frequenz" (Mathematical filtering of measuring values; applications in the area of time and frequency), *PTB-MITT*, **79**, No. 4, pp. 247-252 (August 1969) (in German).
- [22] Barnes, J. A., and Jarvis, S. J., Jr., "Efficient numerical and analog modeling of flicker noise processes," *Nat. Bur. Stand. (U.S.) Tech. Note 604*, 22 pages (USGPO, June 1971).
- [23] Glaze, D. J., "Improvements in atomic cesium beam frequency standards," *IEEE Trans. on Instrum. and Meas.*, **IM-19**, No. 3, pp. 156-160 (August 1970) (see chap. 5A).
- [24] Risley, A. S., Allan, D. W., Gray, J. E., Shoaf, J. H., Machlan, H. E., Glaze, D. J., Peters, H. E., Johnson, E. H., Vessot, R. F. C., and Levine, M. W., "Long term frequency stability of a NASA prototype hydrogen maser" (Summary), *CPEM Digest* (1970 Conf. on Precision Electromagnetic Meas., Boulder, CO 80302, June 2-5, 1970), pp. 74-75 (IEEE, New York, NY 10017, 1970).
- [25] Allan, D. W. and Gray, J. E., "Comments on the October 1970 *Metrologia* Paper 'The U.S. Naval Observatory clock time reference and the performance of a sample of atomic clocks'," *Metrologia*, **7**, No. 2, pp. 79-82 (April 1971).
- [26] Jespersen, J. E., Blair, B. E., and Gatterer, L. E., "Characterization and concepts of time-frequency dissemination," *Proc. IEEE*, **60**, No. 5, pp. 502-521 (May 1972) (see chap. 10).
- [27] Watt, A. D., Plush, R. W., Brown, W. W., and Morgan, A. H., "Worldwide VLF standard frequency and time signal broadcasting," *J. Research Nat. Bur. Stand. (U.S.) (Radio Propagation)*, **65D**, No. 6, pp. 617-627 (November/December 1961).
- [28] Morgan, A. H., "Distribution of standard frequency and time," *Proc. IEEE*, **55**, No. 6, pp. 827-836 (June 1967).
- [29] Winkler, G. M. R., "Path delay, its variations, and some implications for the field use of precise frequency standards," *Proc. IEEE*, **60**, No. 5, pp. 522-529 (May 1972).
- [30] Viezbicke, P. P. (Ed.), "NBS time and frequency services bulletin" (Published monthly by the Frequency-Time Broadcast Services Section, NBS, Boulder, CO 80302).
- [31] Davis, D. D., Jespersen, J. L., and Kamas, G., "The use of television signals for time and frequency dissemination," *Proc. IEEE (Lett.)*, **58**, No. 6, pp. 931-933 (June 1970).
- [32] Howe, D. A., "Nationwide precise time and frequency distribution utilizing an active code within network television broadcasts," *IEEE Trans. on Instrum. and Meas.*, **IM-21**, No. 3, pp. 263-276 (August 1972).
- [33] Allan, D. W., Machlan, H. E., and Marshall, J., "Time transfer using nearly simultaneous reception times from a common transmitter," *Proc. 26th Ann. Symp. on Frequency Control* (U.S. Army Electronics Command, Ft. Monmouth, NJ 07703, June 6-8, 1972), pp. 309-316 (Electron. Ind. Assn., Washington, DC 20006, 1972).
- [34] Becker, G., Fischer, B., Kramer, G., and Muller, E. K., "Wissenschaftliche Abhandlungen der Physikalisch-Technischen Bundesanstalt" (Scientific Trans. of the PTB), **22**, pt. 1, pp. 41-42 (1970) (in German).
- [35] Mungall, A. G., "The second order Doppler shift in cesium beam atomic frequency standards," *Metrologia*, **7**, No. 2, pp. 49-56 (April 1971).
- [36] Allan, D. W., Glaze, D. J., Machlan, H. E., Wainwright, A. E., Hellwig, H., Barnes, J. A., and Gray, J. E., "Performance, modeling, and simulation of some cesium beam clocks," *Proc. 27th Ann. Symp. on Frequency Control* (U.S. Army Electronics Command, Ft. Monmouth, NJ 07703, June 12-14, 1973), pp. 334-346 (Electron. Ind. Assn., Washington, DC 20006, 1973).
- [37] Computed from the Bureau International de l'Heure, Cir. D. Bull. (BIH, Paris, France, 1972).
- [38] CGPM, *Comptes Rendus des Séances de la Quatorzième Conférence Générale des Poids et Mesures* (Proceedings of the Sessions of the 14th General Conference of Weights and Measures) (Paris, France, October 4-8, 1971), pp. 49-52; 77-78 (BIPM, Sevres, France, 1972) (in French—see chap. 1-ann. 1.A.3).
- [39] Smith, H. M., "International time and frequency coordination," *Proc. IEEE*, **60**, No. 5, pp. 479-487 (May 1971).
- [40] Besson, J., "Comparison of national time standards by simple overflight," *IEEE Trans. on Instrum. and Meas.*, **IM-19**, No. 4, pp. 227-232 (November 1970).
- [41] Pali, G. N. and Fedorov, Y. F., "Method of relating time scales with the aid of a satellite link and terrestrial television networks" (translated from *Izmeritel'naya Tekhnika*, No. 3, pp. 23-26, March 1972), *Meas. Tech. (USSR)*, **15**, No. 3, pp. 380-384 (Consultants Bureau, New York, NY 10017, March 1972).

## ANNEX 9.A.

### OPTIMUM FILTERS FOR VARIOUS NOISE PROCESSES (Eq (9.19))

This Annex considers in detail optimum filters for noise processes in eq (9.19) as follows:

$$\mu = \begin{cases} -2, & \text{for } \alpha \geq 1 \text{ and } \tau_f \gg 1; \\ -\alpha - 1, & \text{for } -3 < \alpha < 1. \end{cases} \quad (9.19)$$

(Optimum, as used here, gives a minimum squared error of time prediction  $\langle \epsilon_{\text{opt}}^2(\tau) \rangle$ .)

The cases for  $\alpha = 2, 0, -2$  are straightforward. For  $\alpha = 2$ , white noise PM, the time fluctuations are already a white noise process; hence, the simple mean of the residual time fluctuations is the optimum predictor, and the standard deviation of the

## ANNEX 9.B.

### TIME DISPERSION WITH RECURSIVE FILTER APPLIED TO FLICKER NOISE FM

The second term on the right of eq (9.25) gives the mean-squared time error after an interval  $\tau$  when a recursive filter, as in eq (9.20), is applied to a flicker noise FM process of intensity  $h_{-1}$ . Such a filter is approximately equal to an exponential filter having a time constant  $m\tau$ . Since from table 9.1 we have the following

$$\sigma_y^2(\tau) = 2h_{-1} \ln(2), \quad (9.B.1)$$

the mean-squared time error due to  $h_{-1}$  in eq (9.25) may be rewritten as:

$$\langle \epsilon^2(\tau) \rangle = \sigma_y^2(\tau) F(m) \cdot \tau^2, \quad (9.B.2)$$

where

$$F(m) = \frac{1}{2 \ln(2) m^2 (2m+1)} \sum_{k=1}^{\infty} \left( \frac{m}{m+1} \right)^k k^2 \ln k. \quad (9.B.3)$$

Table 9.B.1 is a list of some pertinent values for  $F(m)$ . The time dispersion due to flicker noise FM over an interval  $\tau$  may be easily calculated (the square root of eq (9.B.2)) by use of table 9.B.1 once we know the stability  $\sigma_y(\tau)$ , and the value of  $m$ .

TABLE 9.B.1. Correspondence of Values  $m$  and  $F(m)$  in eq (9.B.3)

$$F(m) = \frac{1}{2 \ln(2) m^2 (2m+1)} \sum_{k=1}^{\infty} \left( \frac{1}{m+1} \right)^k k^2 \ln k \quad (9.B.3)$$

$m$	$F(m)$	$m$	$F(m)$
0	2.00	10	2.60
0.1	1.93	20	2.99
0.2	1.89	30	3.23
0.3	1.86	40	3.42
0.4	1.85	50	3.56
0.5	1.85	60	3.69
0.6	1.84	70	3.79
0.7	1.85	80	3.88
0.8	1.85	90	3.96
0.9	1.86	100	4.03
1.0	1.87	200	4.51
2	1.97	300	4.80
3	2.08	400	5.00
4	2.18	500	5.16
5	2.27	600	5.29
6	2.35	700	5.40
7	2.42	800	5.49
8	2.48	900	5.59
9	2.54	1000	5.65

mean is an estimate of  $\langle \epsilon^2(\tau) \rangle$ . In timekeeping practice this predictor has not been very useful since white noise PM usually predominates in high performance clocks for times only much shorter than 1 second.

For  $\alpha=0$ —white noise FM or random walk of phase (time)—the random walk time fluctuations may be reduced easily to a white noise process by taking the first finite difference for discrete data ( $\Delta x(j)$ ) or the time derivative  $\left( \frac{dx(t)}{dt} \right)$  for the continuous case. The simple mean of either of these over the data set is the optimum predictor. This is equivalent to predicting the time from the residual rate given in eq (9.15), i.e., using the residual times at the beginning and end of the data set. The mean-square time dispersion is given by eq (9.18) where  $\tau_c$  is the time interval over the data set. Obviously  $\tau_c$  should be kept much larger than  $\tau$ , the prediction interval, for optimum data usage where white noise FM is the predominate random perturbation. This noise process predominates in many frequency standards and in most cesium beam frequency standards for values of  $\tau$  at least in the range  $1 \text{ s} \leq \tau \leq 10^5 \text{ s}$ —see figure 9.1. Hence, this noise process is fundamental in atomic timekeeping.

For  $\alpha = -2$ —random walk FM reduces to a white noise process by taking the second finite difference for equally spaced discrete data ( $\Delta^2 x(j)$ ) or the second time derivative  $\left( \frac{d^2 x(t)}{dt^2} \right)$  for the continuous case. For the discrete case the optimum time prediction at  $t + \tau$  for the random fluctuations would then be given by:

$$\hat{x}(t + \tau) = \overline{\Delta^2 x} + 2x(t) - x(t - \tau), \quad (9.A.1)$$

where  $\overline{\Delta^2 x}$  is the average over the data set. The mean-square time error is given by:

$$\langle \epsilon^2(\tau) \rangle = 2\tau^2 \sigma_y^2(\tau), \quad (9.A.2)$$

which is also equal to  $\langle (\Delta^2 x)^2 \rangle$ .

For  $\alpha=1$  and  $\alpha=-1$ —flicker noise PM and its integral flicker noise FM—the optimum prediction problem is more sophisticated. Recently some work has been done showing how flicker noise can be efficiently generated from white noise [21]; Barnes and Jarvis have pointed out that such a filter could be used in reverse to transform flicker noise into white noise. Once the appropriate averaging and inverse transformations were taken, one would have, in principle, an optimum flicker filter over an arbitrary number of decades of  $\tau$ . We are studying this technique at the present time; however, in the past we have investigated some very simple recursion relationships which yield near optimum time prediction (see sec. 9.3.2, eq (9.20)).

## ANNEX 9.C.

### MINI-COMPUTER PROGRAM FOR FIRST ORDER TIME SCALE ALGORITHM

This program is written in a Fortran dialect compatible with a mini-computer which has a 4k twelve-bit word memory. The computation has been simplified with Fortran variables redefined, in an effort to work within the capabilities of the mini-computer. The program of computation is explained by the Fortran listing with its comment statements. In these statements the computed time scale is often called the "paper clock."

Input required by the computer program:

- DAY2 If initial values are to be supplied, DAY2 is 9, otherwise it is the date on which the clock readings were taken, i.e., the modified Julian day number.
- FN(I) is the number of measurement intervals to be used as a time constant when computing a new rate for clock I.
- R(I) is the rate of clock I with respect to that of the paper clock in nanoseconds per day.
- D(I) is the time of clock I with respect to the paper clock in nanoseconds;  $D(I) = \text{clock I} - \text{paper clock}$ .
- SIG(I) is  $\langle \epsilon_I^2(\tau=1d) \rangle^{1/2}$  for clock I in nanoseconds.
- SUME(I) is the total time error (nanoseconds) accumulated by clock I, with respect to the paper clock, since sum error was last set equal to zero.

DAY1 is the date on which the last set of readings were taken.

$T$  is the hour at which the readings were taken. In this program,  $T$  is not used in the computation, the readings being taken at the same time each day.

D31 is the time interval, in nanoseconds, between the 1 pps of clock 3 and that of clock 1, etc. for all the other clock differences entered into the program.

D3S is the time interval, in nanoseconds, between the 1 pps of clock 3 and that of clock S. Clock S is the on-line clock which approximates UTC(NBS)—often called the working standard.

Interpretation of the computer printout:

- (1) Modified Julian day: The date.
- (2) Clock number: The clocks of the ensemble are numbered 1 through 8.
- (3) Error: The error in nanoseconds, accumulated by clock I during the measurement interval, with respect to the paper clock.
- (4) Frequency: The frequency of clock I with respect to that of the paper clock, in parts in  $10^{14}$ , averaged over the measurement interval.
- (5) Sigma of the set: Corresponds to  $\langle \epsilon_I^2(\tau=1d) \rangle^{1/2}$  in eq (9.25).
- (6) Time of the working standard: The time of clock S with respect to the paper clock in nanoseconds.

The remaining output is data that is to be put back into the computer for computation on the next day.

In case of clock reset, the following are unchanged: sum error, rate, and sigma. The "Error" printout has the same significance as usual, and the rate is unadjusted.

Fortran listing follows:

```

C;      TIME SCALE PROGRAM (15 MARCH 71). A MINUS (-) INDICATES THAT
C;      THE CLOCK IS EITHER LOW IN FREQUENCY OR LATE IN TIME.
1;      FORMAT(I,E,E,E,E,/)
2;      FORMAT("CLOCK ",I,"RESET",/)
3;      FORMAT(//,"SMPL AVG RATE          TIME          SIGMA
4;      FORMAT(E)
5;      FORMAT(I,E,E,/)
6;      FORMAT(//,"MODIFIED JULIAN DAY ",E,/)
7;      FORMAT(/////)
8;      FORMAT("TIME OF WORKING STANDARD IS ",E,/)
9;      FORMAT(//,"SIGMA OF SET ",E,/)
        DIMENSION R(8), D(8), SIG(8), ER(8), DP(8), IRJT(8), SUME(8), FN(8
11;     FORMAT(//,"CLOCK      ERROR      FREQ X 10 TO 14",/)
        N1=1
        N8=8
10;     ACCEPT 4, DAY2
        IF (DAY2-9.) 30,30,40
30;     DO 39 I=N1,N8
        ACCEPT 4, FN(I), R(I), D(I), SIG(I), SUME(I)
39;     CONTINUE
        ACCEPT 4, DAY1
        GO TO 10
40;     ACCEPT 4, T, D31, D32, D34, D35, D84, D86, D37, D3S
        T=DAY2-DAY1
        DO 49 I=N1,N8
        DP(I)=R(I)*T + D(I)
        IRJT(I)=0
49;     CONTINUE
        N=0
50;     ER(1)=DP(1)-D3S+D31
        ER(2)=DP(2)+D32-D3S
        ER(3)=DP(3)-D3S
        A=D34-D3S
        ER(4)=DP(4)+A
        ER(5)=DP(5)+D35-D3S
        ER(6)=DP(6)+A-D84+D86
        ER(7)=DP(7)-D3S+D37
        ER(8)=DP(8)+A-D84
        ANRM=0.
        DS=0.
        DO 69 I=N1,N8
        IF (IRJT(I)-N) 68,68,69

```

```

68; DS=DS+ER(I)/SIG(I)**2
ANRM=ANRM+1./SIG(I)**2
69; CONTINUE
DS=DS/ANRM
DAY1=0.
DO 79 I=N1,N8
ER(I)=DS-ER(I)
DAY1=DAY1+ER(I)*ER(I)
79; CONTINUE
M=0
DO 89 I=N1,N8
A=ER(I)*ER(I)-.2*DAY1-4.E4
IF (A) 86,87,87
86; A=(ER(I)/T)*(ER(I)/T) - 9.*SIG(I)**2
IF (A) 88, 85, 85
87; IRJT(I)=9
GO TO 84
88; IRJT(I)=0
GO TO 89
85; IRJT(I)=N8
84; M=M+1
89; CONTINUE
IF (M-N) 60,90,60
60; N=M
GO TO 50
90; TYPE 6, DAY2
TYPE 11
ANRM=SQTF(1./ANRM)
DO 98 I=N1,N8
DAY1=DP(I) + ER(I)
IF (IRJT(I)) 10,91,96
91; SUME(I)=SUME(I)+ER(I)
A=(DAY1-D(I))/(T*.864)
R(I)=(R(I)*FN(I)+.864*A)/(FN(I)+1.)
ERNM=SQTF(ER(I)*ER(I))/T+.8*ANRM**2/SIG(I)
C=(31.*SIG(I)**2+ERNM**2)/32.
SIG(I)=SQTF(C)
GO TO 97
96; TYPE 2, I
97; D(I)=DAY1
TYPE 5, I, ER(I), A
98; CONTINUE
TYPE 9, ANRM
TYPE 8, DS
TYPE 3
DO 119 I=N1,N8
TYPE 1, FN(I), R(I), D(I), SIG(I), SUME(I)
119; CONTINUE
TYPE 7
DAY1=DAY2
GO TO 10
END

```

## ANNEX 9.D.

### SELECTED BIBLIOGRAPHY ON TIME SCALES AND THEIR FORMATION

- [B1] Allan, D. W., "Statistics of atomic frequency standards," *Proc. IEEE*, **54**, No. 2, pp. 221-230 (February 1966).
- [B2] Allan, D. W., "Statistical modeling and filtering for optimum atomic time scale generation," *Proc. Frequency Standards and Metrology Seminar* (Laval University, Quebec, Canada, August 30, 31, September 1, 1971), H. Hellwig (Ed.), pp. 388-410 (Dept. Elec. Eng., Laval Univ., Quebec, Canada, June 1972).
- [B3] Allan, D. W., Fey, R. L., Machlan, H. E., and Barnes, J. A., "An ultra-precise time synchronization system designed by computer simulation," *Frequency*, **6**, No. 1, pp. 11-14 (January 1968).
- [B4] Allan, D. W., Gray, J. E., and Machlan, H. E., "The NBS atomic time scale system: AT(NBS), SAT(NBS), and UTC(NBS)," (summary) *Proc. 24th Ann. Symp. on Frequency Control* (U.S. Army Electronics Command, Ft. Monmouth, NJ 07703, April 27-29, 1970), p. 361 (Electron. Ind. Assn., Washington, DC 20006, 1970).
- [B5] Allan, D. W., and Gray, J. E., "Comments on the October 1970 Metrologia Paper The U.S. Naval Observatory clock time reference and the performance of a sample of atomic clocks," *Metrologia*, **7**, No. 2, pp. 79-82 (April 1971).
- [B6] Allan, D. W., Gray, J. E., and Machlan, H. W., "The National Bureau of Standards atomic time scales: generation, dissemination, stability, and accuracy," (*Proc. of the 1972 Conf. on Precision Electromagnetic Meas. (CPEM)*, Boulder, CO 80302, June 26-29, 1972); *IEEE Trans. on Instrum. and Meas.*, **IM-21**, No. 4, pp. 388-391 (November 1972).
- [B7] Barnes, J. A., "The development of an international atomic time scale," *Proc. IEEE*, **55**, No. 5, pp. 822-826 (June 1967).
- [B8] Barnes, J. A., and Allan, D. W., "An approach to the prediction of coordinated universal time," *Frequency*, **5**, No. 6, pp. 15-20 (November-December 1967).
- [B9] Barnes, J. A., Andrews, D. H., and Allan, D. W., "The NBS-A time scale—its generation and dissemination," *IEEE Trans. on Instrum. and Meas.*, **IM-14**, No. 4, pp. 228-232 (December 1965).
- [B10] Barnes, J. A., Chi, A. R., Cutler, L. S., Healey, D. J., Leeson, D. B., McGunigal, T. E., Mullen, J. A., Jr., Smith, W. L., Sydnor, R. L., Vessot, R. F. C., and Winkler, G. M. R., "Characterization of frequency stability," *IEEE Trans. on Instrum. and Meas.*, **IM-20**, No. 2, pp. 105-120 (May 1971) (see chap. 8).
- [B11] Barnes, J. A., and Fey, R. L., "Synchronization of two remote atomic time scales," *Proc. IEEE (Corresp.)*, **51**, No. 11, p. 1665 (November 1963).
- [B12] Barnes, J. A., and Jarvis, S., Jr., "Efficient numerical and analog modeling of flicker noise processes," *Nat. Bur. Stand. (U.S.) Tech. Note 604*, 22 pages (USGPO, June 1971).
- [B13] Becker, G., "Von der Astronomischen zur Atomphysikalischen Definition der Sekunde." (From the astronomical to the atomic definition of the second), *PTB-Mitt.*, **76**, No. 4, pp. 315-323 and No. 5, pp. 415-419 (August and October 1966) (in German).
- [B14] Becker, G., "Mathematische Filterung von Messwerten; Anwendungen im Bereich von Zeit und Frequenz," (Mathematical filtering of measuring values; applications in the area of time and frequency), *PTB-Mitt.*, **79**, No. 4, pp. 247-252 (August 1969) (in German).
- [B15] Becker, G., "Über die Begriffe Phase, Phasenzeit und Phasenwinkel bei Zeitabhängigen Vorgängen," (About the terms phase, phase time, and phase angle in time dependent processes), *PTB-Mitt.*, **81**, No. 5, pp. 348-352 (October 1971) (in German).
- [B16] Becker, G., "Was ist eine Zeitskala?," (What is a time scale?), *PTB-Mitt.*, **81**, No. 6, pp. 405-411 (December 1971) (in German).
- [B17] Besson, J., "Comparison of national time standards by simple overflight," *IEEE Trans. on Instrum. and Meas.*, **IM-19**, No. 4, pp. 227-232 (November 1970).
- [B18] BIPM (International Bureau of Weights and Measures), "Changement de la définition de la seconde," (Change of the definition of the second), *Comptes Rendus des Séances de la Trièzième Conférence Générale des Poids et Mesures*, (Proc. Meet. of 13th General Conf. of Weights and Measures, October 10-16, 1967; October 15, 1968, Paris, France), pp. 58-60; Unit of time (second) resolution, p. 103 (Gauthier-Villars & Cie, Paris, France, 1969) (in French—see chap. 1-ann. I.A.1).
- [B19] Bodily, L. N., and Hyatt, R. C., "'Flying clock' comparisons extended to east Europe, Africa, and Australia," *Hewlett-Packard J.*, **19**, No. 4, pp. 12-20 (HP Co., Palo Alto, CA 94304, December 1967).
- [B20] Bonanomi, J., Kartaschoff, P., Newman, J., Barnes, J. A., and Atkinson, W. R., "A comparison of the TA<sub>1</sub> and the NBS-A atomic time scales," *Proc. IEEE (Corresp.)*, **52**, No. 4, p. 439 (April 1964).
- [B21] CCDS, "Recommandations du comité consultatif pour la définition de la seconde . . ." (Recommendations of the Consultative Committee for the definition of the second . . .), *Comité consultatif pour la Définition de la Seconde* (CIPM, 5<sup>e</sup> Session, Paris, France, June 18-19, 1970), pp. S21-S23 (CIPM, Sèvres, France, 1971) (in French—see chap. 1-ann. I.A.2).
- [B22] CCIR, "Comparisons of time scales by various methods," CCIR Study Group 7, Doc. 7/8-E, Rep. 363-, *XIIIth Plenary Assembly CCIR* (New Delhi, India, 1970), **III**, pp. 249a-b (ITU: Geneva, Switzerland, 1970).
- [B23] CGPM, *Comptes Rendus des Séances de la Quatorzième Conférence Générale des Poids et Mesures* (Proc. of the Sessions of the 14th General Conference of Weights and Measures) (Paris, France, October 4-8, 1971), pp. 49-52; 77-78 (BIPM, Sèvres, France, 1972) (in French—see chap. 1-ann. I.A.3).
- [B24] CIPM (International Committee of Weights and Measures), *Comité Consultatif pour la Définition de la Seconde* (Consultative Committee for the Definition of the Second), 3<sup>e</sup> Session-1963, 72 pages; 4<sup>e</sup> Session-1967, 29 pages (Gauthier-Villars & Cie, Paris, France, 1964; 1968) (in French).
- [B25] Essen, L., "Time scales," *Metrologia*, **4**, No. 4, pp. 161-165 (October 1968).
- [B26] Essen, L., "A revolution in time-keeping," *Proc. of Conf. on Freq. Generation and Control for Radio Syst.* (C. E. Tate, Chairman, London, England, May 22-24, 1967), *Inst. Elec. Eng. (London) Conf. Publ. No. 31*, pp. 11-15 (Savoy Place, London, England, 1967).
- [B27] Fey, R. L., Barnes, J. A., and Allan, D. W., "An analysis of low information rate time control unit," *Proc. 20th Ann. Symp. on Frequency Control* (U.S. Army Electronics Command, Ft. Monmouth, NJ 07703, April 19-21, 1966), pp. 620-635 (NTIS, AD 800 523, 1966).
- [B28] Ganter, W. A., "Modeling of atomic clock performance and detection of abnormal clock behavior," *Nat. Bur. Stand. (U.S.) Tech. Note 636*, 30 pages (USGPO, March 1973).
- [B29] Guinot, B., "Characteristics of a scale of time," *Alta. Frequenza*, **40**, No. 8, pp. 320E-322E (August 1971) (in English).
- [B30] Guinot, B., Feissel, M., and Granveaud, M., *Bureau International de l'Heure Annual Report for 1970* (BIH, Paris, France, 1971).
- [B31] Guinot, B., "Sixième rapport due comité consultatif pour de la définition de la seconde au comité international des poids et mesures," (*Minutes of the 6th Session Consulta-*



- tive Committee for the Definition of the Second) (CIPM, 6<sup>e</sup> Session, Paris, France, July 6-7, 1972) (CIPM, Sèvres, France, 1972) (in French—see chap. 1-ann. 1.C.1.).
- [B32] Guinot, B., and Granveaud, M., "Atomic time scales," *IEEE Trans. on Instrum. and Meas.*, **IM-21**, No. 4, pp. 396-400 (November 1972).
- [B33] Hudson, G. E., "Some characteristics of commonly used time scales," *Proc. IEEE*, **55**, No. 6, pp. 815-921 (June 1967).
- [B34] Kartaschoff, P., and Brandenberger, H., "A digital servo for frequency and time scale conversion," *Proc. 20th Ann. Symp. on Frequency Control* (U.S. Army Electronics Command, Ft. Monmouth, NJ 07703, April 19-21, 1966), pp. 577-586 (NTIS, AD 800 523, 1966).
- [B35] Kovalevsky, J., "Astronomical time," *Metrologia*, **1**, No. 4, pp. 169-180 (October 1965).
- [B36] Leschiutta, S., "The IEN time scale as an application of some ideas on timekeeping," *Proc. Frequency Standards and Metrology Seminar* (Laval University, Quebec, Canada, August 30, 31-September 1, 1971), H. Hellwig (Ed.), pp. 411-430 (Dept. Elec. Eng., Laval Univ., Quebec, Canada, June 1972).
- [B37] Markowitz, W., "The atomic time scale," *IRE Trans. on Instrum.*, **1-11**, Nos. 3 and 4, pp. 239-242 (December 1962).
- [B38] Milton, J. B., "Standard time and frequency: its generation, control and dissemination from the National Bureau of Standards Time and Frequency Division," *Nat. Bur. Stand. (U.S.) Tech. Note 379*, 27 pages (USGPO, August 1969) (see future updates).
- [B39] Morris, D., Daams, H., Mungall, A. G., Bailey, R., Miller, L. G., and Thompson, M. M., "Atomic frequency standards and timekeeping at the National Research Council," *Proc. Frequency Standards and Metrology Seminar* (Laval University, Quebec, Canada, August 30, 31-September 1, 1971), H. Hellwig (Ed.) pp. 119-146 (Dept. Elec. Eng., Laval Univ., Quebec, Canada, June 1972).
- [B40] Mungall, A. G., "Atomic time scales," *Metrologia*, **7**, No. 4, pp. 146-153 (October 1971).
- [B41] Mungall, A. G., Daams, H., and Bailey, R., "Note on atomic timekeeping at the National Research Council," *Metrologia*, **5**, No. 3, pp. 73-76 (July 1969).
- [B42] NBS, "Nation gets unified time system" *Nat. Bur. Stand. (U.S.) Tech. News Bull.*, **53**, No. 2, p. 34 (USGPO, February 1969).
- [B43] Newman, J., Fey, R. L., and Atkinson, W. R., "A comparison of two independent atomic time scales," *Proc. IEEE(Corresp.)*, **51**, No. 3, pp. 498-499 (March 1963).
- [B44] Putkovich, K., "Automated timekeeping," *IEEE Trans. on Instrum. and Meas.*, **IM-21**, No. 4, pp. 401-405 (November 1972).
- [B45] Winkler, G. M. R., "Explanation and requirements for universal time," *Proc. PTTI (Precise Time and Time Interval Strategic Planning Meeting)*, (USNO, Washington, DC 20390, December 10-11, 1970), **1**, pp. 152-155 (NTIS, AD 881 014-L, 1970).
- [B46] Winkler, G. M. R., Hall, R. G., and Percival, D. B., "The U.S. Naval Observatory clock time reference and the performance of a sample of atomic clocks," *Metrologia*, **6**, No. 4, pp. 126-134 (October 1970).
- [B47] Yoshimura, K., "The generation of an accurate and uniform time scale with calibrations and predictions," *Nat. Bur. Stand. (U.S.) Tech. Note 626*, 64 pages (USGPO, November 1972).

## CHAPTER 10

# TIME AND FREQUENCY DISSEMINATION: AN OVERVIEW OF PRINCIPLES AND TECHNIQUES\*●

Byron E. Blair†

### Contents

	Page
10.1. Introduction.....	235
10.2. Dissemination Concepts.....	235
10.2.1. Basic Considerations Inherent in Transfer of Time and Frequency.....	235
10.2.2. Frequency from Time Measurements.....	237
10.2.3. Elements that Characterize the Dissemination System.....	237
10.2.4. Basic Techniques Common to a Clock Synchronization System.....	238
10.3. Radio Dissemination of Time and Frequency.....	239
10.3.1. Radio Propagation Factors.....	240
10.3.2. Radio Dissemination Techniques.....	240
a. Standard Frequency and Time Broadcasts.....	240
b. Very Low Frequency (VLF) Time and Frequency Systems.....	241
c. Low Frequency (LF) Time and Frequency Dissemination.....	245
d. High Frequency (HF) Time and Frequency Dissemination.....	247
e. Radio Navigation Systems for TFD.....	251
(1) Omega navigation system for TFD.....	251
(2) Loran-C navigation system for TFD.....	253
(3) Loran-A navigation system for TFD.....	257
f. Television TFD Techniques.....	259
g. TFD via Earth Satellites.....	269
h. Microwave Time and Frequency Transfer (SHF).....	281
i. Commercial Radio TFD Techniques.....	282
j. TFD from VHF Signals Reflected from Meteor Trails.....	283
10.3.3. Advanced T/F Systems Using Radio Techniques.....	284
a. Very Long Baseline Interferometry (VLBI) Time Synchronization.....	284
b. Moon Bounce Time Synchronization (MBTS).....	286
c. Aircraft Collision Avoidance System (ACAS).....	288
10.4. Dissemination of Time and Frequency via Portable Clock.....	290
10.4.1. On-Site Visits.....	292
10.4.2. Aircraft Flyover.....	293
10.5. TFD via Other Means.....	294
10.5.1. Time Transfer via Optical Pulsar Signals.....	294
10.5.2. TFD in Telephone Line and Coax Cable Transmission.....	296
10.5.3. Power Line (60-Hz) Signals as a Time Transfer Technique.....	298
10.6. T/F User and System Evaluation.....	299
10.6.1. Classification of T/F Users.....	299
10.6.2. Evaluation of T/F Systems.....	300

\*Manuscript received April 1, 1973.

●Parts of this chapter have been modified from "Characterization and concepts of time-frequency dissemination" published in *Proc. IEEE*, May 1972 (see reference [16]). Publication herein is at concurrence of the IEEE.

†Time and Frequency Division, Institute for Basic Standards, National Bureau of Standards, Boulder, CO 80302. ●

	Page
10.7. Conclusions.....	302
10.8. References.....	303
Annex 10.A. Characteristics of Radio Frequency Bands 4 through 10.....	310a
Annex 10.B. Characteristics of Standard Frequency and Time Signals in Allocated Bands...	311
Annex 10.C. Characteristics of Stabilized Frequency and Time-Signal Emissions Outside Allocated Frequency Assignments.....	312
Annex 10.D. Characteristics of Frequency Stabilized Navigation Systems Useful for Time/Frequency Comparisons.....	313

"In any observation process there must be a signal coming from the observed system to the recording apparatus, and since the propagation of any signal requires a finite time interval, this gives the possibility of defining the arrival of the signal to be 'later' than the time of emission."

L. Rosenfeld, *Study of Time*, p. 479

This chapter reviews basic concepts and common elements that characterize time and frequency dissemination. The means by which time and frequency can be disseminated fall into four main categories: radio broadcasts, on-site comparisons, events in nature, and hardline wire systems. Interrelated elements include active and passive transfer methods and supplementary techniques available from systems with differing primary objectives (piggyback operations). Three categories of time and frequency users are classified according to accuracy needs, and means of providing these needs are shown. Various characteristics of time and frequency dissemination systems are charted and evaluated in terms of such factors as accuracy, ambiguity, geographical coverage, reliability, cost of user equipment, etc. Appraisal of these factors reveals many interrelationships and limitations to be functions of nature, economics, need, and availability. Annexes give descriptions of radio frequency propagation in various bands as well as characteristics of stabilized radio broadcasts useful for time and frequency dissemination.

The most accurate means of time and frequency dissemination today is through portable clocks, such as on-site visits and/or aircraft flyover; accuracy needs of the majority of time and frequency users can be met in a variety of ways; and existing or planned navigation and communication systems show excellent potential for time-frequency dissemination at little or no additional cost. We conclude that (1) no one system will satisfy all user needs, (2) any general purpose timing system should cost the user in proportion to his accuracy requirements, and (3) existing or proposed electronic systems with a time-frequency dissemination capability should be utilized to the fullest extent to realize frequency/spectrum conservation.

Key words: AC power lines; Aircraft Collision Avoidance System (ACAS); aircraft flyover; characteristics of stabilized broadcasts; commercial radio; HF radio; LF radio; line-10 TV; Loran-A; Loran-C; meteor trails; microwave systems; moonbounce; navigation systems; Omega; portable clocks; pulsars; radio propagation; satellite; standard frequency broadcast; telephone; television; TIMATION; time-frequency accuracy; time-frequency dissemination; time-frequency evaluation; time-frequency user needs; timekeeping; TRANSIT; very long base interferometry (VLBI); VLF radio.

## 10.1. INTRODUCTION

In recent years, advances in technologies of communication, transportation/navigation, time-keeping, and space tracking have placed stringent requirements on time and frequency information. In general, one might consider that optimum comparison of frequency standards or time scales to be through side by side measurements in a laboratory. Many needs of time and frequency, however, are at great distances from a standard time and frequency center. In this chapter we consider what means are available to bridge the distance gap between a standard-time and frequency source and a remotely located user. The concept of our presentation is graphically shown in figure 10.1, with a standard time and frequency source at the center of a circle and segments of larger concentric circles portraying various independent means of transferring this standard to a diverse group of users. The majority of dissemination methods employ some type of radio transmission, either in dedicated time and frequency emissions or established systems such as navigation and television. The most accurate means of time and frequency dissemination today is through portable clocks, such as on site visits and aircraft flyover. Looking into the future, one foresees that satellite systems and microwave communication networks will play a large part in providing time and frequency information to many users.

This chapter reviews some of the basic characteristics and limitations shared by most time and frequency dissemination (TFD) systems. Some systems, such as radio stations CHU and WWV, were built specifically for TFD while others, such as the Loran-C navigation system, can be adapted for TFD; in a few cases it even is possible to use a natural event such as a pulsar for time transfer. A user of a TFD system is generally trying to establish one or more of the following: time of day or date; frequency or time interval; and synchronism. The degree to which he can achieve these objectives will depend upon a number of elements which characterize the system, e.g., accuracy, ambiguity, repeatability, coverage, cost, etc. These various factors are interrelated; they are limited by nature, as well as the users' resources and skill. Such characteristics form a common base which permit evaluation of both new and old systems in similar terms of reference. Classification of timing needs into low, medium, and high-accuracy users gives one an overview of the general time and frequency community. From the discussion it is apparent that no one system will satisfy all user needs; that any general purpose timing system should cost the user proportionately to his accuracy requirement; and that actual or proposed electronic systems, having a potential for dissemination of time and frequency at additional modest cost, should be employed to stem a proliferation of limited-scope, special purpose timing systems. The dissemination techniques are

adaptable to a great variety of user needs and these should be properly weighed in any evaluation, consideration, or application of specific methods.

The intent of this chapter is to give a broad overview of various ways of disseminating time and frequency. Because of the scope and breadth of such an objective, one cannot give complete details for a given system; however, we have attempted to include adequate references for further study of specific dissemination techniques. Excellent publications exist which describe general aspects of time and frequency [1, 2, 3, 4].<sup>1</sup> (Our approach does not consider detailed system-receiving techniques; these will be detailed in later NBS publications.) Section 10.2 of the chapter defines and describes basic concepts inherent in time and frequency dissemination. This is followed by a section discussing aspects and techniques of radio dissemination of time and frequency. The final sections of the chapter discuss portable clock techniques, dissemination by other than radio means, and classification of users and evaluation of the various dissemination techniques. Annexes briefly describe radio propagation in various bands and give characteristics of stabilized broadcasts useful for TFD.

## 10.2. DISSEMINATION CONCEPTS

This section touches on basic considerations inherent in the transfer of time and frequency information; discusses elements that characterize the dissemination system; and describes utilization of a transfer standard. The section sets a foundation for comparative insight into the various techniques of time and frequency dissemination. It is taken for granted that the desirability of transferring time and/or frequency from a prime standard to a user as depicted in figure 10.1 is paramount. Frequency/time standards are not discussed in detail in this chapter; for such information the reader is referred to Chapters 2, 3, 4, 5, 6, and 9. We base our discussion on the following clock concepts. A clock is the fundamental component of timekeeping; it consists of a frequency standard, a means for counting and keeping track of oscillations, and a readout device for displaying the count. Often an interpolation device is added for use between counts. In essence, a clock is a device which accumulates the cycles of an oscillator (frequency standard) and presents the result in some convenient form.

### 10.2.1. Basic Considerations Inherent in Transfer of Time and Frequency

There are several basic concepts implicit in the transfer of time and frequency information, including date, frequency or time interval, and time/frequency (T/F) synchronization. By *date* we mean time of day

<sup>1</sup>Figures in brackets refer to the references at end of this chapter.

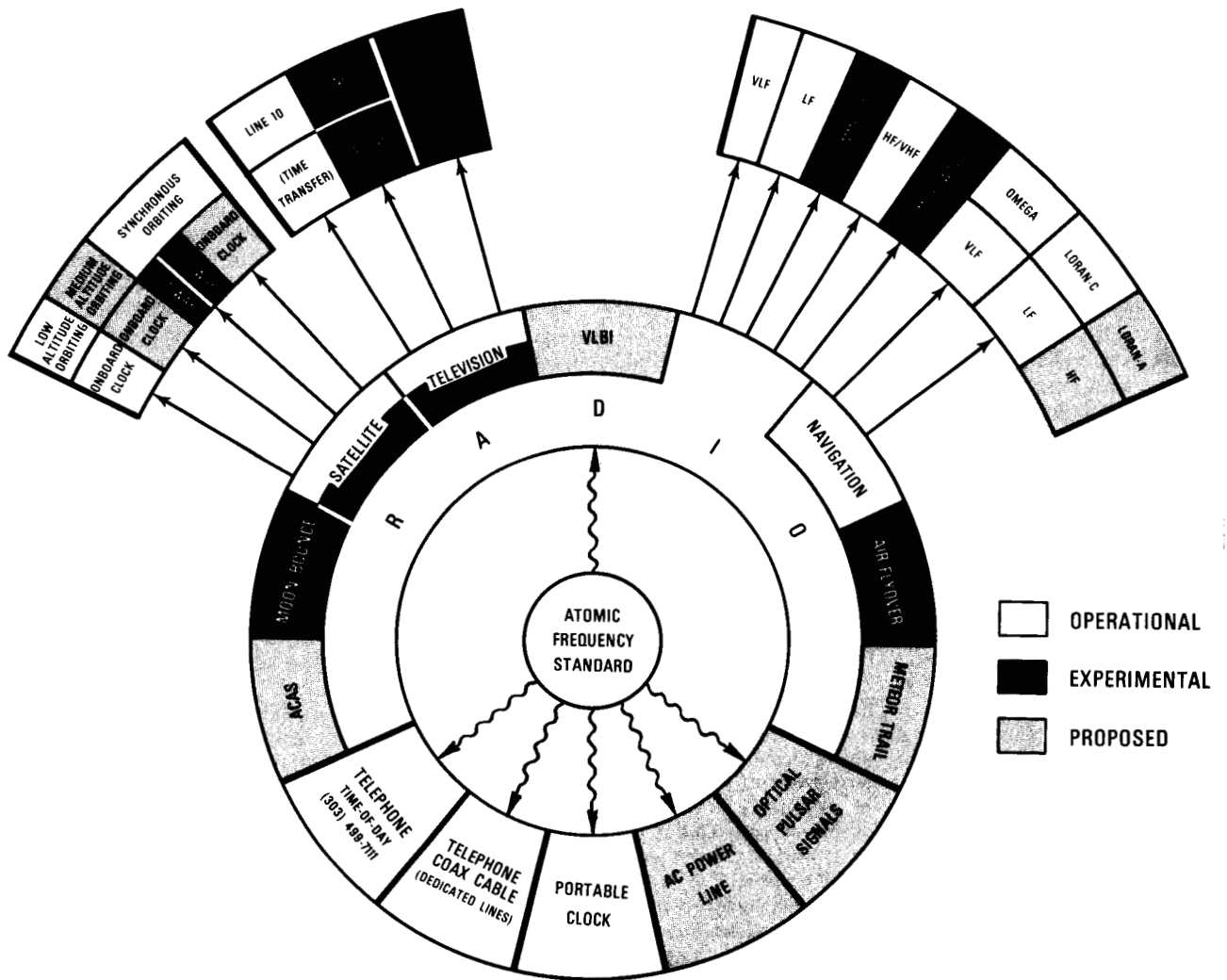

FIGURE 10.1. Concept and methods of time and frequency dissemination.

such as 1965, July 12th, 12h, 24m, 43.010 . . . s. In other words the time of an event reckoned from some consensual origin. *Time interval* refers to duration—the difference in time between two dates. Note that a time interval of 1h can be shown by a clock that is not on time, although running at the correct rate. Also, time interval and frequency are closely related concepts; the frequency of some phenomenon can be determined by the number of occurrences within a measured time interval. Synchronized clocks read the same time at a given point in time, although not necessarily on the basis of an absolute time scale. A coherent communications system is a good example of showing a requirement for synchronization. High rate messages, perhaps of 10  $\mu$ s duration, are transmitted, to an addressee who must be synchronized in time with the sender to obtain the message. For further discussions of these basic concepts the reader is referred to Chapter 1.

Time is a basic dimension that, apart from physical aspects, influences everyone. History has shown man attempting to keep time by various crude and sundry instruments such as water buckets, candles, sundials, and pendulum clocks [5]. In today's world, time indicators vary from wristwatches, chronometers, wall clocks, and radio signals to crystal oscillator and atomic clocks. Each of these timing devices shows varying degrees of accuracy and precision; a wristwatch meets a casual need, whereas exact time may require an atomic clock. For any particular event to occur, within some accuracy framework, it is important that all devices maintaining time indicate the same time of day; but since all time pieces are less than perfect, they gradually “drift” and must be continually set to a standard. The time standard has evolved through the years as pointed out by Humphrey Smith [6], and today the second is defined in terms of the resonance of cesium (see chap. 1). However, the cesium standard is much more stable than a time standard based on the earth movement, i.e., the lengths of atomic seconds are nearly identical. On the other hand, atomic time is essentially independent of that time required by navigators, geodesists, astronomers, and others requiring time based on earth rotation. Thus, a time scale called UT1 (universal time corrected for polar motion of earth) is also necessary; UT1 is referenced to the 0 meridian at Greenwich.

Many people today depend upon the electric wall clock whose rate is fixed by the power company's generator. In the United States the power utilities synchronize their generators to the National Bureau of Standards' low frequency broadcast, WWVB [7]. Thus, the U.S. clocks generally run at the same rate. The U.S. citizenry normally set such clocks through time announcements, either by radio or telephone.

Radio timing signals can be used either to perform a clock function or to set clocks. When one uses a radio wave instead of a clock, however, new considerations evolve. One is the delay time of approximately 3 $\mu$ s per km (propagation delay) it takes the

radio wave to propagate and arrive at the reception point. Thus, a user 1000 km from a transmitter receives the time signal 3 ms later than the on-time transmitted signal. If time is needed to better than 3 ms, correction must be made for the travel delay. An additional allowance must be made for the signal to pass through the antenna/receiver (receiver delay). Other problems related to radio wave propagation will be discussed later on.

In most cases the standard time and frequency emissions such as CHU, JJY, WWV, and WWVH are more than adequate for everyday needs. The launching of earth satellites during the late 1950's, however, required synchronization of worldwide tracking networks to better than 1 ms. In addition, the appearance of portable atomic frequency standards initiated planning of new navigational and communication systems requiring microsecond timing.

Today, many systems exist which are able to disseminate standard frequencies and time signals with sufficient convenience and accuracy for most users in metrology. These same systems may be used someday to disseminate other standard units of measurement, including those for electromagnetic force (volt), length (meter), and attenuation (decibel), among others. These dissemination systems, together with the inherently high precision of frequency standards and of frequency/time metrology, may help to establish a unified standard for measurement [8]. The progress and feasibility for a unified standard is discussed also in Chapter 7.

### 10.2.2. Frequency from Time Measurements

Dimensionally, frequency is the reciprocal of time interval. Frequency implies periodic motion or oscillation such as cycles per second (Hz). Its unit can be given as the period of one cycle, i.e.,  $1/60$  Hz  $\approx$  17 ms. It is no surprise, then, that a frequency dissemination service can be useful for timekeeping and that frequency information can be obtained from a time broadcast. Any “time dissemination” service can be used as a frequency reference. If the time difference between a user's clock and the reference clock increases between measurements, the user knows that the oscillator in his clock is running at a different rate than that of the reference clock, and he can compute his frequency offsets.

### 10.2.3. Elements that Characterize the Dissemination System

A number of common elements characterize most time/frequency dissemination systems. Among the most important are: accuracy, ambiguity, repeatability, coverage, availability of time signal, reliability, ease of use, cost to the user, and the number of users served. There does not now appear to be any single system which incorporates all desired characteristics. The relative importance of these

characteristics will vary from one user to the next, and the kind of compromise solution for one user may not be satisfactory to another. We will introduce these common elements through detailed examination of a possible radio signal.

Consider a very simple system consisting of an unmodulated 10-kHz signal as shown in figure 10.2.

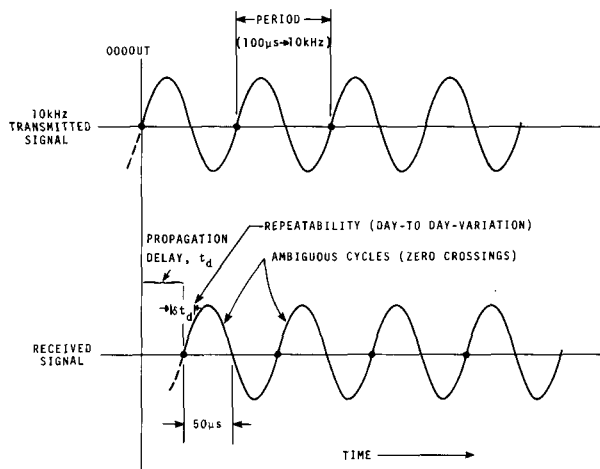

FIGURE 10.2. Single tone time dissemination.

A positive going zero-crossing of this signal, leaving the transmitter at 0000 UT, will reach the receiver at a later time equivalent to the propagation delay. The user must know this delay because the accuracy of his knowledge of time can be no better than the degree to which this delay is known. (By accuracy we mean the degree of conformity to some specified value or definition.) Since all cycles of the signal are identical, the signal is *ambiguous* and the user must somehow decide which cycle is the "on time" cycle. This means, in the case of our hypothetical 10-kHz signal, that the user must know the time to  $\pm 50\mu\text{s}$  (half the period of the signal). Further, the user may desire to use this system, say once a day, for an extended period of time to check his clock or frequency standard. However, it may be that the delay will vary from one day to the next, and if the user is unaware of this variation, his accuracy will be limited by the lack of *repeatability* of the signal arrival time.

Many users, geophysicists and seismologists for example, are interested in making time coordinated measurements over large geographic areas. They would like all measurements to be referenced to one time system to eliminate corrections for different time systems used at scattered and/or remote locations. This is a very important practical consideration when measurements are undertaken in the field. In addition, a one reference system, such as a single time broadcast, increases confidence that all measurements can be related to each other in some known way. Thus, the *coverage* of a system is an important concept. Another

important characteristic of a timing system is the *percent of time available*. The man on the street who has to keep an appointment needs to know the time perhaps to a minute or so. Although he requires only coarse time information, he wants it on demand so he carries a wrist watch that gives the time to him 24 hours a day. On the other hand, a user who needs time to a few microseconds employs a very good clock which only needs an occasional update, perhaps only once or twice a day. An additional characteristic of time/frequency dissemination is *reliability*, i.e., the likelihood that a time signal will be available when scheduled. Propagation fadeout can sometimes prevent reception of HF signals. The characteristics discussed so far are for the most part related to the design of the signal and to the propagation characteristics of the medium. However, there are some important economic and human considerations.

Economic and human factors in a TFD system include (1) the cost of establishing and maintaining the service; (2) the number of users to be served by the system; (3) the cost of equipment investment to meet a given need; (4) the operator skill required for operation; and (5) data analysis required for timekeeping.

These factors are interrelated such that various combinations can determine accuracy levels, number of users served, and ultimate costs to both TFD sender as well as receiver. It appears to be an important corollary that the cost to the user for a particular time service should be proportional to the level of need. It is also true that as the accuracy needs become more stringent the number of potential users decrease.

#### 10.2.4. Basic Techniques Common to a Clock Synchronization System

*Identification, synchronization, and delay calibration* are three operations that are common to all time dissemination schemes. In a standard time emission an event such as the transition from the zero to the one state in a binary system, or the beginning of a tone or a particular zero-crossing of a continuous tone in an analog system, is chosen to represent the time mark. This event must be identified unambiguously at the time reference transmitting station, and synchronized with the reference clock. The equipment delay is calibrated and the transmitted time adjusted accordingly. In order to recover the time from the received signal, a user must unambiguously identify the time mark in the signal format and synchronize his clock to it after accounting for the delay both in propagation and the receiving equipment. Thus identification, synchronization, and calibration operations must be performed at both the master and the user time stations. In the case of a standard time broadcast service these operations are being performed simultaneously by many users, while they are being performed only once at the reference station.

The dissemination "system" should be construed to include the equipment of all users as well as that of the reference station. The costs of the standard time broadcast service "system" are allocated such that the investment in user equipment at a single user station is vastly less than the investment in equipment at the reference station. Thus a standard time broadcast service is designed along the lines of a public utility, where a great many customers require the availability of similar services at all times. It is convenient, but not necessary in principle, for time or frequency information to be transferred from the reference station to the user station by a radio emission originating at the reference station.

Let us now consider the concepts of a time-transfer system as shown in figure 10.3. Assume that the reference station A and the user station B both have receivers tuned to monitor some electromagnetic event that is going to occur at a remote location TS. The coordinates of locations A, B, and TS are not known but are fixed. Both points A and B have monitoring devices that will record the time displayed by their clocks at the reception of the electromagnetic disturbance associated with the event. Finally, assume that clocks A and B are on time with each other. At  $t_A$  seconds after the event occurs, the time  $T_A$  displayed by clock A will be recorded, where  $t_A$  is the propagation delay from TS to point A. (This clock reading will depend on both the propagation delay and when the event occurred.) The time  $T_B$ , displayed in clock B, will be recorded  $t_B$  seconds after the event occurs. Since the time at which the event occurred is not known, and since the distances of points A and B from the source TS are not known,  $t_A$  and  $t_B$  are not predictable. But if the time readings  $T_A$  and  $T_B$  are compared (i.e., subtracted), one can learn the difference in  $\tau_{d1}$  in the propagation delay time along the two fixed paths. If a second event is monitored at some later time the new readings,  $T'_A$  and  $T'_B$ , recorded at A and B will obviously be different from the first set. But the time difference  $\tau_{d1}$  will be the same as before (provided that the clocks are still synchronized).

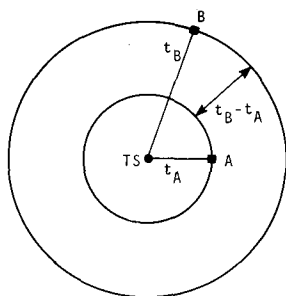

DIFFERENTIAL TIME BETWEEN STATIONS A AND B,  $\tau_{d1} = t_B - t_A$

FIGURE 10.3. Time transfer system.

A change in this difference,  $\tau_{d1}$ , could only be explained by a loss of coordination or change in path delay between clocks A and B. If clock B is adjusted by an amount equal to the change in  $\tau_{d1}$  then it will once again be synchronized with clock A, since we had assumed initially that clocks A and B were synchronized. If no further loss of synchronization occurs,  $\tau_{d1}$  computed for yet another event will be identical to its initial value. Thus the time difference between a reference clock and a user's clock can be determined by comparing each in turn to an independent "tick" available to both, and then differencing the comparisons. It resembles comparisons with a portable standard known to be operating at the correct rate but not necessarily on time. The time is "transferred" by a standard which is not, itself, on time; hence the term "time-transfer" technique.

The example used was chosen to emphasize the following aspects of the transfer standard technique:

- (1) The coordinates of the reference station, the user station, and the source of the transfer standard need not be known although they must not change.
- (2) The "event" monitored contains no time information, and the time of its occurrence need not be known; it must only be unambiguously identifiable.
- (3) If the "transfer standard" is a radio broadcast, as it normally is, the transmitting station plays no active part in the process and need not even be aware that it is being so used.

The requirement that the event must be unambiguously identifiable implies that the time separation between "events" must be greater than the uncertainty associated with the knowledge of both the user's clock time, and the propagation delays. If other means are employed to maintain gross clock coordination and the "transfer" technique is being used to keep track of short-term drifts, then the time separation of events need only be greater than the peak-to-peak drifts involved. Synchronization pulses from commercial television transmitters serve nicely for this purpose; Loran-C is also commonly used.

If a user wishes to initiate this technique to transfer time to a location having a clock not known to be on time, he may begin making comparisons and bring in a portable clock to "calibrate" the link at his convenience. He can then reconstruct the time history of his clock prior to the portable clock visit as well as maintain an "on time" clock.

### 10.3. RADIO DISSEMINATION OF TIME AND FREQUENCY

This chapter attempts to delineate distinguishing features of both present and future means of dis-



seminating time and frequency information to a distant user. Radio waves are essential to most dissemination techniques. Although different radio frequency bands show characteristic and relevant traits, and a multitude of techniques have emerged in these bands within the last 40 years, the words of NBS scientists in 1932 still hold true; "radio waves of which the frequency is carefully controlled and accurately known furnish a standard of frequency which is simultaneously available everywhere that the waves can be received." [9]. In 1932 the *transmitted* accuracy of WWV, based on the primary frequency standard was about  $1 \times 10^{-6}$ ; this accuracy could readily be obtained from received signals. Today the accuracy of the *transmitted* signal has been improved some five or six orders of magnitude, but the accuracy of the received signal has lagged considerably behind.

### 10.3.1. Radio Propagation Factors

Radio has offered attractive means of transferring standard time and frequency signals since the early 1900's [10]. As opposed to the physical transfer of time via portable clocks, the transfer of information by radio entails propagation of electromagnetic radiation through some transmission medium from a transmitter to a distant receiver. Let's consider a typical standard frequency and time emission.

In such broadcasts the signals are directly related to some master clock and are transmitted with little or no degradation in accuracy. In a vacuum, and noise free background, one should be able to receive such signals at a given point essentially as transmitted, except for a constant path delay with the wave propagating near the speed of light (i.e., 299,773 km/s). The propagation media, including the earth, atmosphere, and ionosphere, as well as physical and electrical characteristics of transmitters and receivers, influence the stability and accuracy of received radio signals, dependent upon the frequency of transmission and length of signal path. Variation and anomalies in propagation delays are affected in varying degrees by extraneous radiations in the propagation media, solar disturbances, diurnal effects and weather conditions, among others.

It is possible to classify radio dissemination systems in a number of different ways; one could divide those carrier frequencies low enough to be reflected by the ionosphere (below 30 MHz) from those sufficiently high to penetrate the ionosphere (above 30 MHz). The former may be observed at great distances from the transmitter but suffer from ionospheric propagation anomalies that limit accuracy; the latter are restricted to line-of-sight applications but show little or no signal deterioration caused by propagation anomalies. The most accurate systems tend to be those which use the higher, line-of-sight, frequencies, while broadcasts of the lower carrier frequencies show the greatest number of users.

A complete evaluation of propagation characteristics of the various bands used for time and frequency dissemination is beyond the scope of this chapter. (Frequency bands 4 through 10 are used and include VLF through SHF (3 kHz to 30 GHz)).<sup>2</sup> A summary description of propagation factors and general experience in these bands is given in the table of Annex A. Descriptions and mathematical models of the propagation medium useful for designing and understanding time/frequency dissemination systems are given by Wait, Budden, Crombie and others [11, 12], Johler [13], Davies [14], and Thompson et al. [15], among others. Various noise processes, such as additive and multiplicative, and considerations in signal design for TFD systems have been discussed by Jespersen et al. [16]. Basic understanding of radio propagation in the various frequency bands should permit one to optimize a choice for either dissemination or reception of time/frequency information.

### 10.3.2. Radio Dissemination Techniques

Referring to figure 10.1, one sees the variety of radio means for disseminating time and frequency information. This section gives pertinent characteristics of the various techniques, including advantages and limitations, and refers the reader to in-depth studies of various aspects. These techniques include dedicated systems as well as those outside the allocated bands; included are VLF, LF, and HF broadcasts; navigation systems; and methods using television, satellites, and microwave signals. Passing mention is made of techniques of limited potential such as meteor burst and commercial radio broadcasts. In this cursory survey lack of space prevents comprehensive analyses of various systems; some of the newer and more promising techniques are described at some length.

#### a. Standard Frequency and Time Broadcasts

The World Administrative Radio Council (WARC) has allocated certain frequencies in five bands for standard frequency and time signal emission as shown in table 10.1. For such dedicated standard frequency transmissions the CCIR recommends that carrier frequencies be maintained so that the average daily fractional frequency deviations from the internationally designated standard for measurement of time interval should not exceed  $\pm 1 \times 10^{-10}$ . Annex B gives characteristics of standard frequency and time signals that are assigned to allocated bands, as reported by the CCIR. Annex C gives characteristics of stabilized frequency and time signals that are broadcast outside the allocated frequencies which can, however, provide

<sup>2</sup>By international agreement, frequency band "N" is the frequency range between  $0.3 \times 10^6$  Hz and  $3.0 \times 10^6$  Hz. Thus, band 6 lies between 300 kHz and 3 MHz. See Annex 10.A.

TABLE 10.1. *International standard time and frequency radio assignments*

Band No.	Designation	Frequency Range
4	VLF (Very Low Frequency).	20.0 kHz $\pm$ 50 Hz.
6	MF (Medium Frequency).	2.5 MHz $\pm$ 5 kHz.
7	HF (High Frequency)	$\left\{ \begin{array}{l} 5.0 \text{ MHz} \pm 5 \text{ kHz.} \\ 10.0 \text{ MHz} \pm 5 \text{ kHz.} \\ 15.0 \text{ MHz} \pm 10 \text{ kHz.} \\ 20.0 \text{ MHz} \pm 10 \text{ kHz.} \\ 25.0 \text{ MHz} \pm 10 \text{ kHz.} \end{array} \right.$
9	UHF (Ultra High Frequency).	400.1 MHz $\pm$ 25 kHz (satellite).
10	SHF (Super High Frequency).	$\left\{ \begin{array}{l} 4.202 \text{ GHz} \pm 2 \text{ MHz} \\ \text{(satellite-space to earth).} \\ 6.427 \text{ GHz} \pm 2 \text{ MHz} \\ \text{(satellite-earth to space).} \end{array} \right.$

useful time and frequency information. Information contained in Annexes B and C includes transmitter coordinates, frequency, radiated power, and accuracy of transmitted signals. The map in figure 10.4 shows the location of many radio stations used for TFD.

**b. Very Low Frequency (VLF) Time and Frequency Systems**

TFD systems in the VLF band nominally operate at frequencies from 10 to 30 kHz. The 10–13 kHz band is used by the Omega Navigation system and is described later in Section 10.3.2.e.(1). In this section we describe briefly the development and uses of VLF apart from the Omega system. VLF and the related LF transmissions are not new; they were used in the early 1900's for long range communications between colonial empires, by various navies, and for general transoceanic services [17, 18]. Even at that time VLF transmissions showed

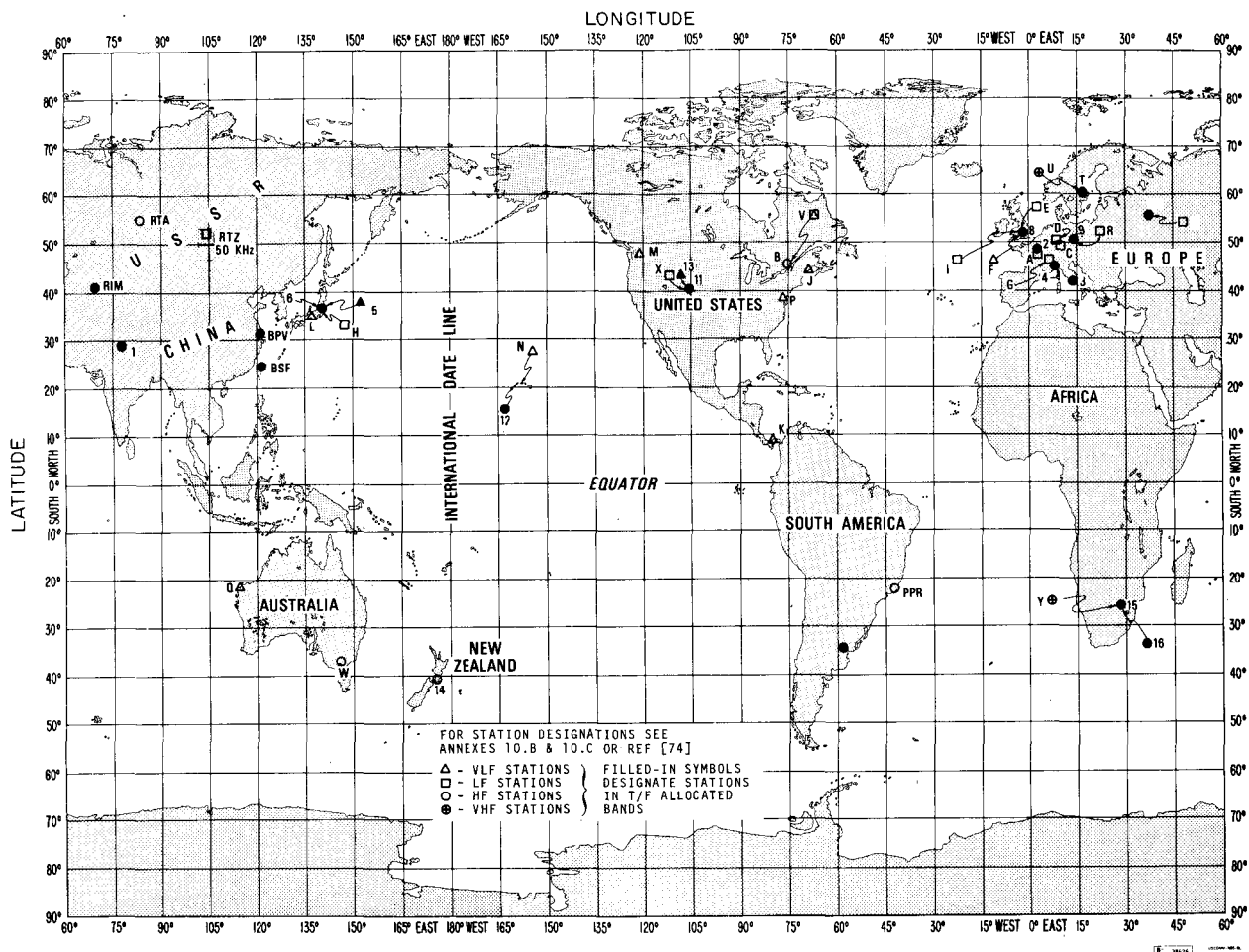

FIGURE 10.4. Worldwide location of broadcasting stations useful for TFD. (annexes 10.B and 10.C give additional information to keyed broadcast stations.)

good reliability with relatively low signal attenuation over large distances [19]. Many of these transmissions were replaced later by the lower-cost high frequency (HF) broadcasts which employed much smaller antennas, at increased efficiency over VLF antennas. Many different VLF antenna configurations have been built, e.g., long cables have been strung several km across volcano craters and valleys or from towers several hundred meters in height [18]. The present NAA antenna at Cutler, Maine (radiated power 1 Megawatt) is a top hat system supported by 26 masts  $\sim 300$  m in height, covering an area  $\sim 2.2$  km<sup>2</sup>; its radial ground system consists of  $\sim 3.3 \times 10^6$  m of buried copper wire.

During World War II and shortly thereafter, attention was directed again to the low frequency band for navigation and communication. From such interest evolved the "Radux" navigation system [20, 21], where the low frequency carriers showed the excellent stability required for navigation systems. From the mid-1950's onward, there have been great strides in worldwide frequency and time comparisons via low frequency broadcasts. Methods used by Pierce, Mitchell, and Essen [22]; Pierce [23]; and Crombie et al. [24], among others showed improvement in frequency comparisons of two to three orders of magnitude better than those of HF techniques. It is particularly noteworthy that the more stable atomic frequency standards were replacing the crystal oscillator control of many of the VLF transmissions about this same time; thus in 1960, Pierce, Winkler and Corke showed that transatlantic phase comparisons of a 16-kHz carrier frequency could be made to about 2  $\mu$ s in a 24h period using atomic cesium standards [25]. Attention thus was directed towards VLF standard frequency broadcasts [23, 26, 27], and the VLF method has proven advantageous for comparing atomic frequency standards at global distances [28-32]. Today most VLF transmissions used for TFD are controlled by atomic frequency standards referenced to a coordinated international time base (UTC—see chap. 1). This has resulted in a reasonably economic and reliable means of disseminating frequency to several parts in  $10^{11}$  or better in a 24h period.

The characteristics of various VLF broadcasts (outside the Omega band) useful for TFD are given in Annex 10.C. The propagation of VLF signals is described in Annex 10.A. Of particular significance are the diurnal phase shifts which are somewhat frequency dependent but quite distance related. Typically, these predictable shifts range from  $\sim 20$  to 80  $\mu$ s for distances of 2000 to 10,000 km at frequencies of  $\sim 14$  to 20 kHz [33, 34].

Within the last decade a variety of VLF techniques have been developed for time and frequency comparison. These methods have confirmed the

excellent stability shown in the 1950's and even today there is evidence that the limiting precision of VLF measurements has not been reached [35, 36]. We will briefly review several VLF time and frequency techniques.

(1) *VLF Single Frequency Comparison.* A common and economical VLF method utilizes single frequency phase comparison, such as shown in figure 10.5 [37]. In such an electromechanical system the servo-driven phase shifter continuously phase locks a synthesized signal from the local standard to the received VLF signal. A linear potentiometer output, connected to a constant direct voltage, generates a voltage signal and permits an analog recording of the phase shifter position. In other words, the recording shows the amount of phase shift the local synthesized signal experiences to agree with the phase of the received signal. A very narrow bandwidth ( $\sim 0.01$  to 0.001 Hz) is required for extraction of the coherent VLF signal level from characteristic higher noise levels  $> 20$  to 40 dB. (Electronic-servo VLF comparators with internal calibrator-signal generators are now available; these units are more stable than the electromechanical type and provide improved control for clock synchronization.)

Measurements are made on the phase records generally at 24h intervals and at times when the propagation path is sunlit and phase fluctuations are minimal. The duration of such a quiet period varies with the seasons, reception path, and the path direction. (The standard deviation of phase fluctuations in NBA signals received and compared at NBS, Boulder—4300 km—were several tenths of a  $\mu$ s for a series of 20 min measurements taken over a 7h period [38].) The single VLF comparison technique does not permit initial clock

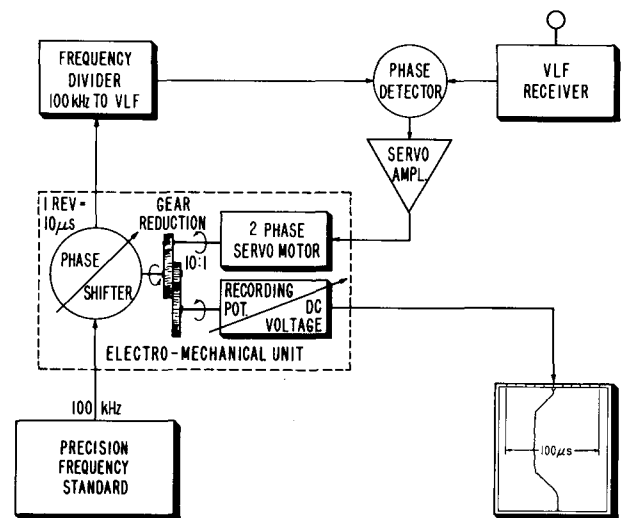

FIGURE 10.5. Typical VLF single-frequency comparator.

synchronization; it does, however, give day to day comparisons of a local clock to microseconds [2, 39–41]. Corrections to many VLF broadcasts can be made after the fact from periodic publications of various laboratories such as NBS [42], the USNO [43], and the Research Institute of the Swedish National Defense [44].

(2) *Multiple-Frequency VLF Techniques.* Another VLF approach is the so-called multiple-frequency technique which uses two or more coherently related, closely spaced signals which are transmitted sequentially [45, 46]. The method is based on similar principles as the Radux-Omega Navigation system [21]. It is the hope that this method might permit initial synchronization of clocks at remote sites and/or resynchronization of interrupted clocks. There is a distinction between such synchronization; i.e., initial synchronization, via a radio signal, requires accurate knowledge of the propagation delay. Initial synchronization along with direct measure of the propagation delay, however, can be performed by transportation of a portable clock to the site. On the other hand, clocks can be resynchronized through the multiple frequency technique by adjusting for the known propagation delay. There is evidence that theoretical predictions of propagation delay compare favorably with experimental results [47].

The multiple carrier VLF method extracts timing information in the difference frequencies, allowing individual *cycle identification* of one of the carrier frequencies. The method has been used with WWVL and is applicable to the Omega frequencies [48, 49]. The technique demands extreme stability in the signals as transmitted, the transmission medium, and the receiving/comparison equipment. In a typical synchronization, coarse time would be set initially via HF radio transmissions to several ms to resolve the difference frequency ambiguity ( $< 1/2$  of the difference frequency period; i.e.  $\sim 2.5$  ms for the dual Omega frequencies of 12.5 and 12.7 kHz). In using Omega frequencies of 12.5 and 12.7 kHz, it is necessary that the residual phase error (differential propagation delay corresponding to one cycle offset  $= \pm 1.26 \mu\text{s}$ ) be less than  $0.6 \mu\text{s}$  for resolving cycle ambiguity at 12.5 kHz [49]. That is, each cycle of 12.5 kHz (individual cycle period of  $80 \mu\text{s}$ ) shows a differential phase offset of  $1.26 \mu\text{s}$  at an appropriate comparison point of the 12.7 kHz signal. The number of error cycles within the difference frequency interval depends upon the so called *magnification factor*,  $f_2/f_2 - f_1$ , or 63.5 in the example of the 12.5 and 12.7-kHz signals ( $f_1$  and  $f_2$  respectively). Thus, the product of the magnification factor and the  $f_2$  period gives the period of the difference frequency. A lower magnification factor places lesser demands on the measurement sensitivity.

The multiple carrier VLF method includes a local calibration signal for simulating the frequency

of the received signal to relate the local time scale to that of the transmitter. Agreement between the received and calibrated VLF phases is made systematically and the local clock phase-shifter adjusted until all simulated signal phases are identical to the actual received signal phases for a single setting of the phase shifter. This phase relationship remains essentially unchanged (except for clock interruption and phase loss), and the VLF receiver can be turned off and on without affecting the calibration.

A basic paradox in using 2 VLF signals for clock synchronization is that an increase in the spacing of the frequencies improves the cycle resolution problem but places more stringent requirements on the coarse timing. Reception of three or more VLF signals, such as provided by Omega, gives a combination of both narrow and wide separation of frequency pairs, thus insuring cycle identification of the prime carrier; the stability, after synchronization, should be equivalent to that of the single frequency system. Several laboratories have used the multifrequency VLF techniques in combination with other systems for resynchronization timing [40, 48].

(3) *VLF Time Transfer Techniques.* A time transfer VLF technique has been demonstrated by Becker [31]. This method also uses a simulated carrier calibration which obtains a daily time difference between the local time scale and the received signal. The USNO simultaneously each day makes identical measurements. The daily differences of these  $\Delta t$ 's gives a time difference of the time scales of the PTB and USNO via given VLF transmissions. These measurements, confirmed by Loran-C data, averaged over an 18 month period (NSS to PTB path  $\sim 6000$  km) show an uncertainty of  $\sim 1 \times 10^{-13}$ . Becker also asserts that filtering and averaging techniques used at the PTB for analysis of VLF data could be employed profitably by the BIH in formation of the International Time Scale (TAI).

(4) *VLF Pulse Methods.* Several VLF transmitters periodically broadcast time signals (see ann. 10.C). Time pulses transmitted at VLF show a slow rise time (15 ms at NBA – 18 kHz in 1960) because of the high Q of the antennas and a resultant large time delay. Stone determined time from the NBA transmitted pulses at Summit, Canal Zone to a receiver at NRL in Washington, DC to a precision of  $\sim 500 \mu\text{s}$  [50]. While such time determinations might be resolved to higher precision, limiting factors include the difficulty in fixing the start of the pulse and the uncertainty of the transmitter, propagation, and receiver delays.

(5) *Statistical Smoothing of VLF Data.* Allan and Barnes [51] and Guétrot et al. [52] have shown means for statistically reducing phase fluctuations on long term data. Guétrot applied optimum smoothing techniques to differential VLF data of NSS (21.4 kHz) and WWVL (20.0 kHz) over reciprocal paths in a study with the USNO. The results were compared

with portable clock measurements and showed day to day deviations of 70 ns over this 2400 km path.

(6) *Time Comparison via Frequency Shift Keying (FSK) of VLF Carriers.* Frequency Shift Keying (FSK) of VLF stabilized communication transmissions has been proposed for TFD [53]. This method shifts two carrier frequencies either plus or minus 50 Hz with bit lengths of 20 ms and a transition time between shifts of 2 ms. At such rates, phase coincidence of the two carrier frequencies occurs at a point within each transition time. The 20 ms time markers will occur nearly continuously and permit coarse timing to such a level. The transition points are "on time" within  $\pm 1 \mu\text{s}$  of the station clocks. FSK transmissions are planned in 1973, and it is believed that the mid-point transition times can be resolved at a receiving site to  $\pm 10 \mu\text{s}$  since the VLF signal periods range from  $\sim 30$  to  $60 \mu\text{s}$  a particular cycle can be identified and time extracted from the cycle zero crossing to  $\sim 1 \mu\text{s}$ . It is proposed also to transmit time-code pulses once an hour, possibly the last five minutes before the hour. Stone et al. [53] give results of two techniques for resolving FSK signals at a receiving station to about  $\pm 10 \mu\text{s}$ ; e.g., through frequency discriminator techniques and/or those of a synchronous detector as used in many VLF tracking receivers. A signal averager is used for optimum resolution. The method shows promise for precise timing although receiving equipment is somewhat complex and costly.

(7) *Summary Statement of VLF Use in TFD.* The stability and reliability of VLF standard frequency transmissions during the last decade is attested to by their use for international comparisons of atomic frequency standards as previously mentioned; for control of HF standard frequency emissions [54]; for navigation [55]; for propagation studies [56–58]; and for adjustment of rubidium frequency standards which control the frequency of color TV broadcasts [59]. The Sperry report on methods for synchronizing remote clocks states in its conclusions: "Do not overlook the possibilities of obtaining both accuracy and low cost in the combination of a clock stabilized by reference to VLF signals and set once by a master clock" [2].

#### *Advantages of VLF systems for TFD*

- VLF phase comparisons can be made to several  $\mu\text{s}$  continuously at continental distances from a transmitter up to  $\sim 10,000$  km and with low signal attenuation and stable propagation. This is an improvement of several orders of magnitude over HF techniques.
- Generally continuous transmission (24h per day) and many stations located at widely separated points.
- Single frequency comparisons can be made with relatively low-cost receiving equipment.
- Most VLF transmitters today are stabilized with atomic frequency standards, which, in part, accounts for VLF signal stability.

- Many VLF transmissions are monitored by national laboratories which publish corrections and permit reference to their time scales (after the fact).
- Although VLF signals are subject to diurnal phase variations, such changes are both predictable and repeatable.
- Once a propagation path is calibrated, multiple frequency VLF techniques can permit resynchronization of clocks at a remote site.

#### *Limitations of VLF Systems Used for TFD*

- Atmospheric noise at VLF is quite high and coherent signals often must be detected well below the noise. Noise from lightning strokes is a maximum at these frequencies, and the low attenuation rates of atmospheric noise at VLF allows worldwide propagation of such static.
- VLF propagation is subject to many phase anomalies such as diurnal variations, cycle slips, strong attenuation over ice fields, solar disturbances (Sudden Ionospheric Disturbances-SID's), long versus short path interference, nuclear blast effects, seasonal changes, and nighttime irregularities. In many cases, however, these are easily recognizable and can be accounted for. Some reduction in phase anomalies can be realized through composite wave analysis suggested by Pierce [60].
- For best results, phase measurements should be made when the transmitter-receiver path is sunlit. Some paths at high latitude can show limited sunlit conditions, however.
- Maximum success in VLF measurements requires atomic frequency standards at both the transmitter and receiver; good temperature control of equipment; back up battery supply for AC power; periodic phase and amplitude calibration for detection of phase drifts or jumps in the local equipment; and periodic checks of antenna connections, circuit board and chassis contacts [58].
- VLF transmissions received at distances of 1000 km or less from a transmitter are difficult to interpret because of the interference between ground and sky waves. There are also sensitive path distances at which modal interference critically destruct a received VLF signal, particularly during sunset and sunrise.
- VLF techniques alone are not now capable for initial clock setting at a remote site. Generally, propagation delay is determined and initial clock setting is performed by a portable clock visit.
- VLF signals experience dispersion (different phase velocities) and this can result in prohibitive variation in received signals for cycle identification in the multiple frequency technique.
- VLF techniques, although simple in concept and design, require experienced personnel to

properly interpret and analyze the signals as transmitted, propagated and received at a remote site.

### c. Low Frequency (LF) Time and Frequency Dissemination

LF signals are transmitted in the band between 30 and 300 kHz. Today, at least 10 LF broadcasts (shown in annexes 10.B. and C.) are frequency stabilized in the accuracy range of  $\pm 0.1$  to 10 parts in  $10^{10}$  and are useful for TFD. As the development of LF transmissions paralleled the VLF broadcasts, no attempt will be made to trace its history. Also, the Loran-C navigation system (100 kHz) is described separately in Section 10.3.2.e.(2).

Although the LF band also has long been known for its stability and reliable propagation to long distances, it was not until the late 1940's that Pierce showed the value of LF transmissions for navigation [20]. In 1950 the British commenced standard frequency broadcasts at 60-kHz (MSF) at daily short intervals of time [61]. In 1956 NBS also commenced low power 60-kHz broadcasts (KK2SEI later changed to WWVB) [62]. From limited broadcasts of these two stations, Pierce was able to predict daily measurement accuracies of 1 or 2 parts in  $10^{11}$  for LF comparisons [63]. He was limited to a large extent by the variable crystal oscillator control of most transmissions at that time. As Pierce's predictions proved true, especially with the advent of atomic frequency control of transmitters, many frequency stabilized LF transmitters were constructed and are used for time/frequency dissemination today.

At this point we will discuss certain low frequency and time measurements in terms of the National Bureau of Standards WWVB broadcasts at 60 kHz. The NBS low-power LF station was moved to Ft. Collins, CO in mid-1963; today its radiated power is  $\sim 13$  kw [64], and it generally can be received as a stable frequency source anywhere in the continental USA. Three types of LF time and frequency comparisons are considered:

(1) *Single-Frequency Phase Tracking at LF.* This method is quite similar to the VLF procedure [65].

LF signals usually propagate with greater attenuation than VLF, although perhaps at improved stability at distances up to  $\sim 2500$  km. Ground wave LF signals provide a very stable reference at distances up to about 500 km. A typical WWVB phase record for the Ft. Collins, CO to Greenbelt, MD path ( $\sim 2400$  km) is shown in figure 10.6. This 50  $\mu$ s full scale record shows (a) the excellent phase stability during the sunlit portion of the path; (b) the repeatable diurnal phase shift at both sunset and sunrise when the effective ionosphere rises and lowers; (c) a typical cycle slip or fadeout at sunrise (Greenbelt); and (d) the somewhat irregular phase pattern when the path is in darkness. It is of particular note that WWVB transmitted with a radiated power of about 2 W at this time with frequency control via a rubidium atomic frequency standard. As previously pointed out, WWVB was used together with WWVL to remotely control the frequency of WWV in Maryland prior to its move to Ft. Collins, CO, to several parts in  $10^{11}$  over a 21-month period [54]. The construction of a simple and economical receiver (cost  $\sim$  \$100) has been described for local WWVB comparisons [66].

(2) *WWVB Time Code.* Although the WWVB antenna shows a relatively high Q, its transmission characteristics are such as to support time code modulation. Since 1965 WWVB has broadcast time information continuously via a 10-dB level-shift carrier code. This binary coded decimal (BCD) code is synchronized with the 60-kHz carrier which, in turn, is referenced to the UTC(NBS) time scale [64]. Figure 10.7 shows the format of the WWVB pulse-width code which is repetitive and updated at one minute intervals. Basically, the code consists of one second markers, generated by reduction of the carrier power by 10 dB at the start of each corresponding second; power is restored 200 ms later for an uncoded marker or binary 0; 500 ms later for a binary 1, and 800 ms later for either a 10-s position marker or minute reference marker. Thus, the leading edge of each negative going pulse is on time; each minute frame contains coded information within 12 groups which includes complete UTC(NBS) time-of-year data in minutes, hours and day-of-year, the estimated difference of UT1 minus UTC (called DUT1), and the positive or negative relationship of the UT1 scale with respect to the UTC scale. The

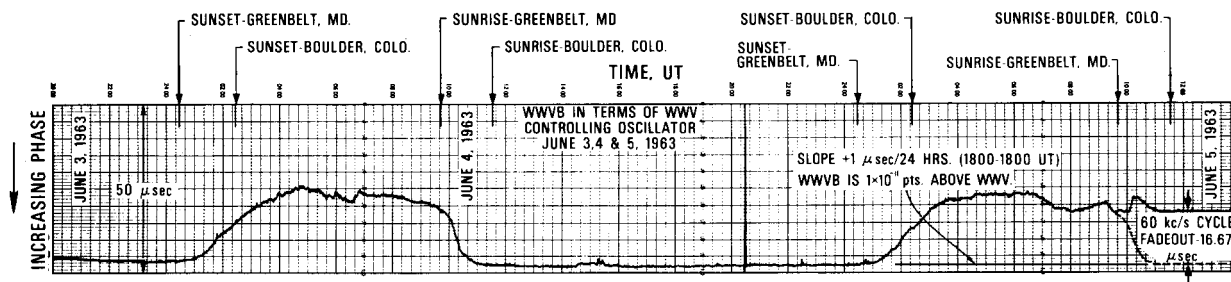

FIGURE 10.6. Typical LF phase record (WWVB transmission from NBS, Boulder, CO and received at Greenbelt, MD).

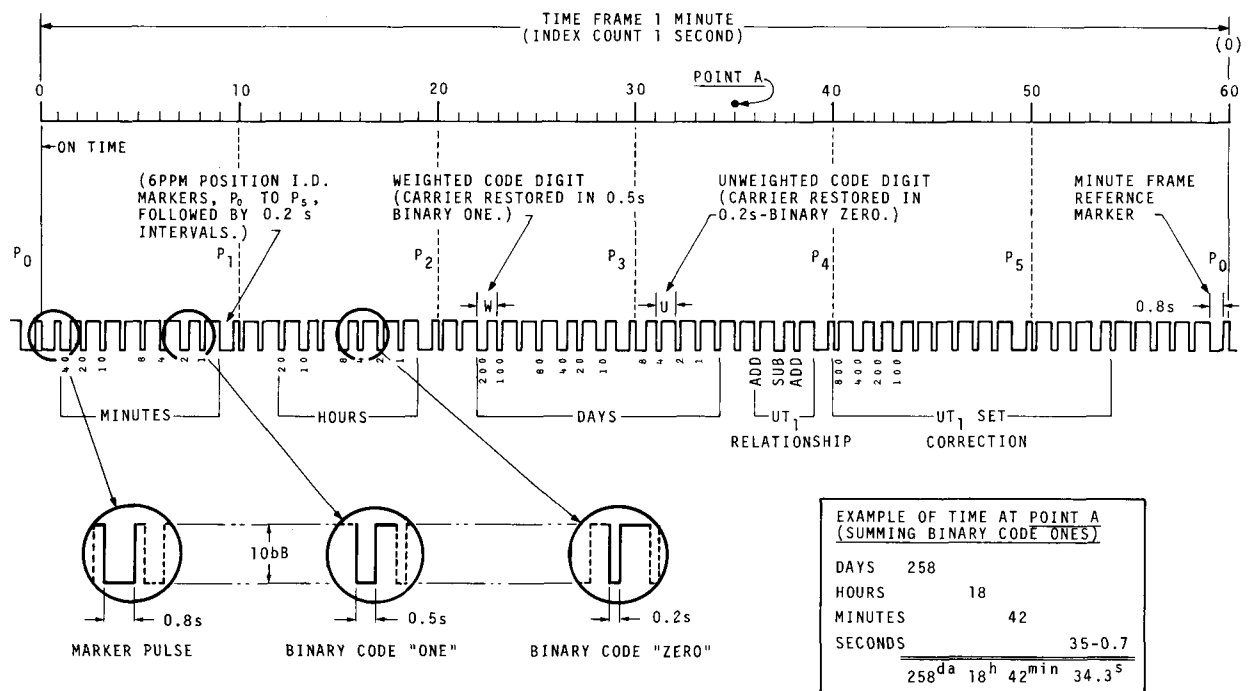

FIGURE 10.7. Format of WWVB one-minute time code.

individual pulses yields seconds information; the minute reference marker begins at zero seconds. Complete details of the WWVB time code are given in reference [64].

Equipment is available for automatically decoding the WWVB time code, and it has been stated that the time information is available to 50  $\mu$ s over a wide geographical area with the provision that propagation delay corrections are made from station WWVB [68]. The WWVB standard frequency and time code broadcasts are used to maintain synchronization of interconnected power grids in the continental U.S. [7]. Improved system control, using these low frequency broadcasts, has been proposed to attain frequency and time agreements between North American power areas of  $\pm 0.001$  Hz at 60 Hz and better than 50 ms respectively [69]. The code is used also for time reference of seismic recordings [70, 71]; and the WWVB 60-kHz signal is used as a standard for the telephone company [72].

(3) *LF Pulse Decay Time Measurements.* Andrews, Chaslain, and DePrins reported on time pulses emitted by HBG (75 kHz) and WWVB (60 kHz) at distances  $\sim 80$  to 1000 km and obtained time to an accuracy of  $\pm 40$   $\mu$ s or better from measurements of the arrival time of an LF pulse [67]. Basically, they selected a point on the decay curve of the pulse (essentially transmitted as a square wave) and, through photographic integration, determined that

the minimum overall error occurs when the amplitude point selected for measurement on the decay envelope is between 75 and 90 percent. The timing error is directly related to the amplitude point chosen and depends also on (a) changes in pulse shape caused by variations in the transmitting antenna; (b) variations in propagation conditions and; (c) amplitude measurement errors of the received pulse envelope. During the measurements it is important that the phase between the received signal and the local reference remain unchanged during the integration time. In Brussels, Belgium the method has been used for time synchronization with  $\sim 40$   $\mu$ s accuracy and for frequency measurements with an error less than 7 parts in  $10^{12}$  over periods of a year [67].

The advantages and limitations of LF transmissions for TFD are quite similar to those shown for VLF. Some additional characteristics might include the following:

#### *Advantages of LF Signals for TFD*

- Stable results are obtained within groundwave distance of an LF transmitter because ground wave and skywave signal interference is not present at such ranges.
- Time pulse modulation, which is possible at LF, permits time synchronization to  $\sim 100$   $\mu$ s or better, provided the propagation delay is known.

- The WWVB time code has proven of value in timing of seismic events, and coordinating North American power grids.
- Single LF phase comparisons can be made at accuracies of parts in  $10^{11}$  per day with reasonably simple and economical receiving equipment.

#### Limitations of LF systems for TFD

- Automated decoding of LF time codes requires relatively expensive equipment.
- Because of attenuation factors LF signals are generally less useful than VLF at large distances from a transmitter ( $> 2500$  km).
- Ionospheric anomalies degrade reception of WWVB in some geographic areas of the United States.
- LF propagation is subject to ionospheric variations; phase changes occur from diurnal effects, solar disturbances, and modal interference. (This latter factor can cause "cycle slippage" at critical propagation distances.)
- As for VLF comparisons, extreme care is required of LF receiving equipment for optimum results. Proper interpretation of data requires experienced personnel.
- It is not now possible to initially set remote clocks to high accuracy via LF radio techniques alone.

#### d. High Frequency (HF) Time and Frequency Dissemination

Today there are some 20 countries broadcasting stabilized HF standard time and frequency signals [73, 74]. Characteristics of many of the international stations, broadcasting in the frequency band between 3 and 30 MHz, are listed in Annex 10.B and 10.C. The ease of usage and worldwide reception capability of HF signals for TFD attests to their acceptance and value. In the U.S. the Navy first broadcast spot-time signals about 1904 [10]; in 1923 the NBS station WWV, commenced standard frequency broadcasts from the Washington, D.C. area. These transmissions were improved and later included standard time signals; in 1948 coverage of such T&F information was extended to the Pacific area with the WWVH emissions from Hawaii. The accuracy of the WWV signals as transmitted and received initially was about a part in  $10^5$ . Improvements in equipment and frequency control raised this to parts in  $10^7$  during the 1950's. Further progress, principally through use of atomic frequency standards as reference oscillators, improved the transmitted accuracy several orders of magnitude to today's value of a few parts in  $10^{12}$  [64]. Unfortunately, ionospheric propagation of HF signals via skywaves generally restricts the accuracy of received standard frequencies to a few parts in  $10^7$  and received time signals to  $\sim 1$

ms. (Long term refinements can improve these accuracies as described later).

Accuracy of signals received beyond groundwave range of an HF transmitter ( $\sim 160$  km) has not improved since World War II. This is shown graphically in figure 10.8 where the frequency accuracy of WWV transmissions is plotted for a 50-year period since 1923. Most of the restrictive ionospheric effects at HF are described in Annex 10.A. These uncontrollable ionospheric factors dictate the accuracy levels of HF time and frequency dissemination via skywaves and would preclude frequency accuracy improvements in the NBS high frequency transmitting equipment. At the receiving end, systems using diversity techniques for automatically and continuously locking on the optimum signal of several WWV or WWVH frequencies may provide some improvement in accuracy of received signals [75]. Also other diversity techniques such as separation of antennas in space, frequency separation and antenna polarization might be beneficial [76].

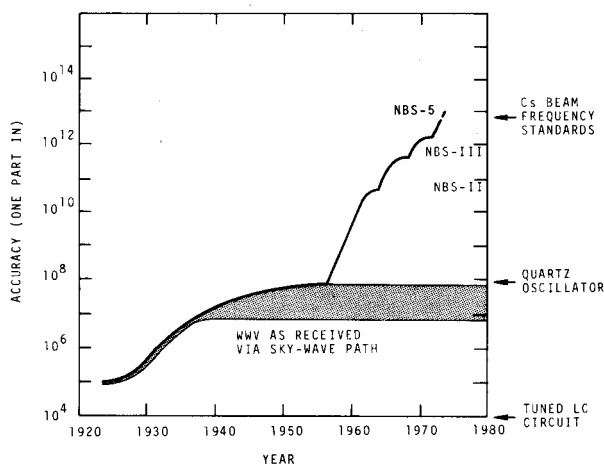

FIGURE 10.8. Accuracy of WWV transmissions from 1923 to 1973. Shaded area shows WWV as received via sky-wave path.

Many excellent HF broadcasts exist for TFD such as CHU, JJY, and MSF; various HF emission formats for TFD are illustrated in reference [73]. At this point we will describe briefly the WWV/WWVH formats to show the composition of a typical HF standard time and frequency transmission.

Station WWV now broadcasts from Ft. Collins, CO at the international allocated frequencies of 2.5, 5.0, 10.0, 15.0, 20.0, and 25.0 MHz [64, 77, 78]; station WWVH transmits from Kauai, Hawaii on the same frequencies with the exclusion of 25.0 MHz.





FIGURE 10.9. WWV transmitter building and antennas at Ft. Collins, CO.

The WWV transmitter building is shown in figure 10.9. The hourly broadcast formats of both WWV and WWVH are shown in figure 10.10; the broadcast signals include standard time and frequencies and various voice announcements. Complete details of these broadcasts are given in reference [64]. Both HF emissions are directly controlled by Cs beam frequency standards with periodic reference to the NBS atomic frequency and time standards [79]; corrections are published monthly [42].

Besides the standard carrier frequencies, an important part of the WWV and WWVH emissions includes audio tones and time ticks as shown in figure 10.10. The 1-second UTC markers are transmitted continuously by WWV and WWVH, except for omission of the 29th and 59th marker each minute. With the exception of the beginning tone at each minute (800 ms) all 1-second markers are of 5-ms duration; these WWV and WWVH pulses consist of 5 cycles of 1000 Hz and 6 cycles of 1200 Hz respec-

tively as shown in figure 10.11; this figure shows also the spectra of the WWV and WWVH pulses. Each pulse is preceded by a 10-ms period of silence and followed by 25 ms of silence; time voice announcements are given also at 1-minute intervals. All time announcements are Greenwich Mean Time and the actual reference time scale is the Universal Coordinated Time Scale UTC(NBS) (see chap. 1 for time zone changes from Greenwich).

WWV and WWVH also continuously emit a 100-Hz time code. This is an IRIG-H type of code with a 1-minute time frame; it uses the BCD system, includes 60 markers per second, and the leading edge of each pulse coincides with a positive zero-axis of the 100-Hz modulating frequency. The code contains similar information to the WWVB time code and 10-ms resolution should be obtainable. For details of the WWV/VH time code see reference [64].

There are various means of using the HF standard frequency and time emissions; they include the

**WWV BROADCAST FORMAT**

VIA TELEPHONE (303) 499-7111  
(NOT A TOLL-FREE NUMBER)

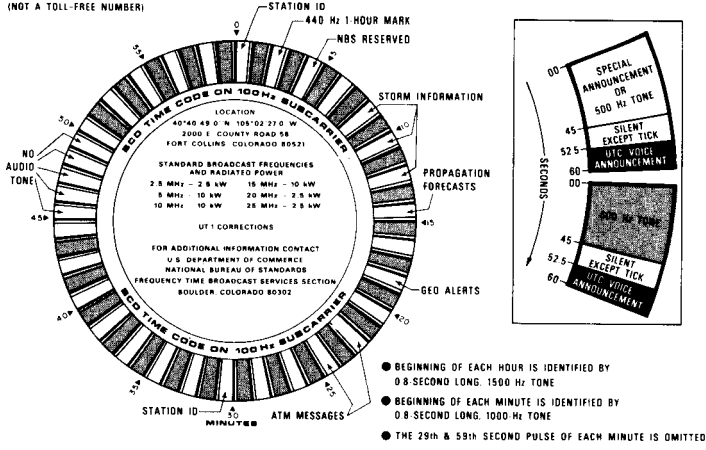

- BEGINNING OF EACH HOUR IS IDENTIFIED BY 0.8 SECOND LONG, 1500 Hz TONE
- BEGINNING OF EACH MINUTE IS IDENTIFIED BY 0.8 SECOND LONG, 1000 Hz TONE
- THE 29th & 59th SECOND PULSE OF EACH MINUTE IS OMITTED

(a)

**WWVH BROADCAST FORMAT**

VIA TELEPHONE (808) 335-4363 (NOT A TOLL-FREE NUMBER)

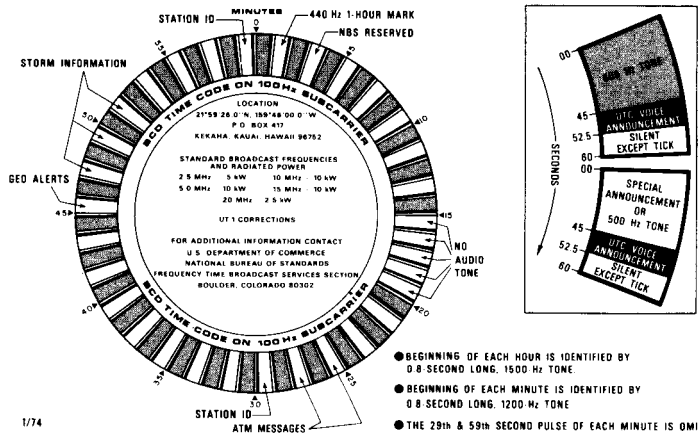

- BEGINNING OF EACH HOUR IS IDENTIFIED BY 0.8 SECOND LONG, 1500 Hz TONE
- BEGINNING OF EACH MINUTE IS IDENTIFIED BY 0.8 SECOND LONG, 1200 Hz TONE
- THE 29th & 59th SECOND PULSE OF EACH MINUTE IS OMITTED

(b)

FIGURE 10.10. Hourly broadcast format of WWV (a) and WWVH (b).

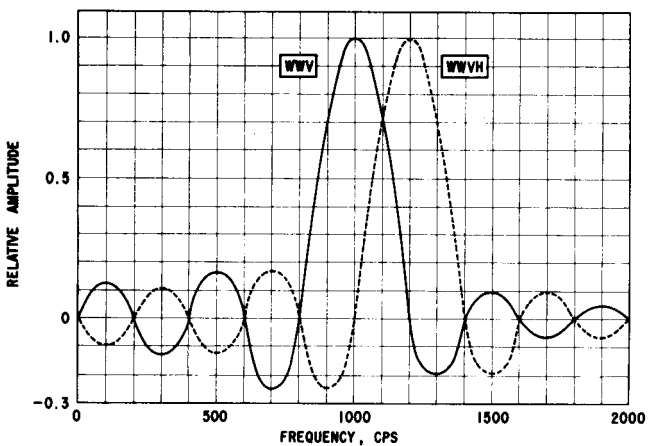

**WWV AND WWVH SECONDS PULSES**

THE SPECTRA ARE COMPOSED OF DISCRETE FREQUENCY COMPONENTS AT INTERVALS OF 1.0 CPS. THE COMPONENTS AT THE SPECTRAL MAXIMA HAVE AMPLITUDES OF 0.005 VOLT FOR A PULSE AMPLITUDE OF 1.0 VOLT. THE WWV PULSE CONSISTS OF FIVE CYCLES OF 1000 CPS. THE WWVH PULSE CONSISTS OF SIX CYCLES OF 1200 CPS.

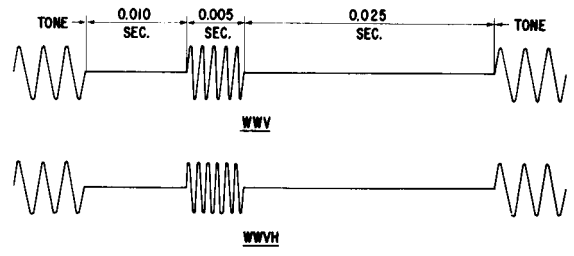

FIGURE 10.11. Characteristics of time-pulse emission from NBS radio stations WWV and WWVH.

zero-beat method of comparing frequencies (employing either multiplication or division to obtain a suitable frequency), time comparisons for either time or frequency information, and decoders for the IRIG-H time code [1, 4, 80, 81]. Although the previously stated accuracies for HF comparisons generally hold, Watt et al., have shown that improvements in precision can be obtained through averaging [27]. Their results are plotted in figure 10.12; frequency measurements are less precise than those by time pulse. They used a running 10-day average technique to obtain precisions of several parts in  $10^{10}$  for a 30-day period. Angelotti and Leschiutta studied the MSF 10-MHz signals (path length 1040 km from Rugby, England to Torino, Italy) and for 3500 independent daily measurements over a 10-year period obtained a yearly mean average time difference of  $200 \mu\text{s}$  between received signals and local clocks. Winkler also reports that WWV can be received at the USNO (15 MHz at the same time each day) to about  $200 \mu\text{s}$  [83].

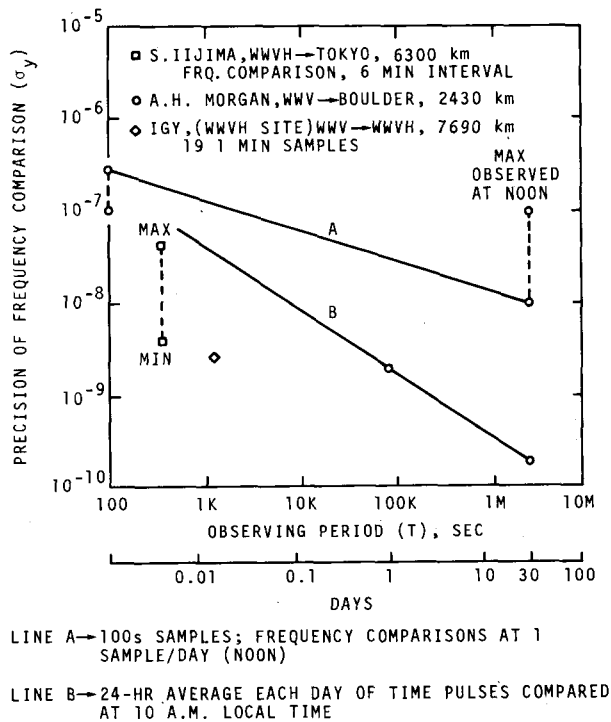

FIGURE 10.12. WWV/WWVH frequency comparison precision (10 MHz).

Optimum HF radio measurements can be obtained by following the below named procedures:

- (a) Make measurements at the same time each day when the radio path is in full daylight or darkness;

- (b) record no measurements when an ionospheric disturbance is in progress;
- (c) use the highest reception frequency which gives consistent results;
- (d) avoid radio paths that pass over or near either auroral zone;
- (e) use a good quality communications or special timing receiver with directional antenna oriented to provide shortest propagation path.

As with all radio systems, the determination of propagation delay limits the usefulness of HF signals for timing. An approximation for propagation delay for one hop skywaves, reflected from the E and F layers of the ionosphere, can be determined from a graph developed by Morgan and shown in figure 10.13 [84]. (E-layer exists during daytime only.) This graph shows an error of about  $400 \mu\text{s}$  for a variation of 200 km in ionospheric height at a 3000 km single hop distance. HF methods are critical, especially at distances where transitions between dominant modes may occur; also in the determination of the existence of one-hop, two-hop, etc., conditions. With consideration of error sources, one can probably estimate HF propagation delay to about 1 ms. Barghausen et al., have

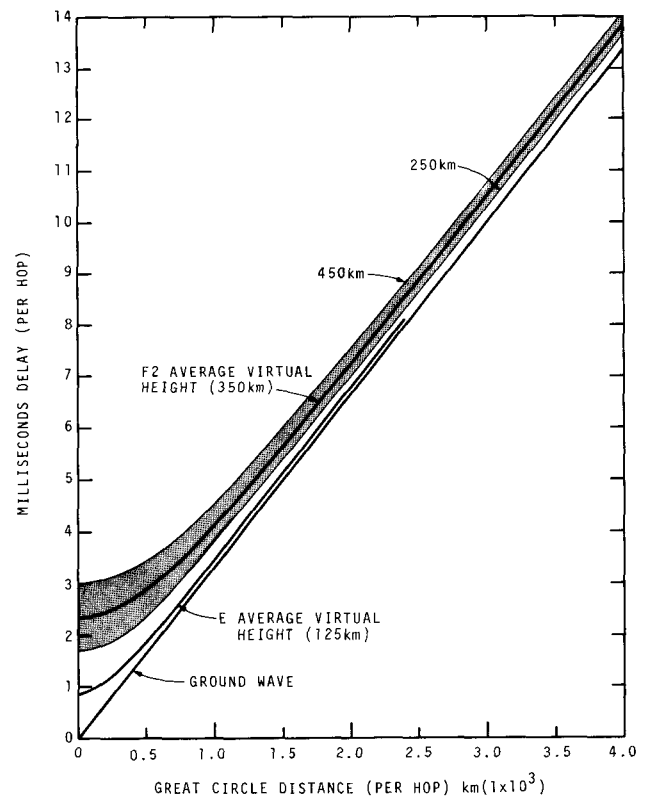

FIGURE 10.13. HF propagation delay versus distance for several ionospheric heights of reflection.

developed methods and techniques for predicting long-term performance of HF telecommunication systems [85]. Their computer programs can yield much useful information on given frequencies and propagation paths as described in Annex 10.A.

*Advantages of High Frequency TFD*

- Receiving equipment and antennas are simple and economical for time accuracies of ~ 1 ms.
- The widespread location of HF time and frequency transmitters, broadcasting UTC signals, enables reception of at least one of these transmissions almost anywhere in the world; they also serve an unlimited number of users simultaneously.
- HF transmitters and antennas are smaller, simpler, and of less cost than the low frequency broadcasting stations.
- Long-term averaging of HF data can remove some propagation anomalies, approaching precisions of parts in  $10^{10}$  over 30-day periods.
- Groundwave signals (~ 160 km from transmitter) can be received with about the same accuracy as transmitted.
- Sufficient bandwidth is available at these frequencies to enable time pulse modulation.

*Limitations of High Frequency TFD*

- Received HF skywave signals suffer erratic excursions in time delay from ionospheric irregularities; this both degrades time and frequency comparisons and causes unreliability of reception.
- Propagation delays of HF skywaves are difficult to determine to better than 1 ms because of ionospheric variability from sunspot activity, time of day, seasons, distance, Doppler shifts, etc.
- The transmission modes (number of hops propagated) are difficult to predict for HF radio paths exceeding ~ 3500 km.
- Atomic frequency control of HF broadcasts give instantaneous frequency stabilities in the transmitted signal some four orders of magnitude greater than that realized at a receiver via skywave propagation; it appears that no equipment improvement can overcome this limitation of nature.

**e. Radio Navigation Systems for TFD**

Radio navigation systems have much in common with standard time and frequency radio emissions [86]. Both depend upon the constancy of the speed of light for their concept of operation and both employ some type of periodic format. Because of some nearly identical requirements in timing, communication, and navigation, various radio transmissions of precisely controlled frequency can serve multiple roles.

As one example of how standard time transmissions can be used for navigation consider the idea of range-range or rho-rho navigation. Refer to figure 10.14; assume that a time signal transmitted from  $T_1$  is received at a ship located at A. If the coordinates of the transmitter are known, and the ship has an on-time clock, one could readily determine the propagation delay,  $t_d$ , of the received signal. This value would enable one to compute the distance,  $d_1$  (since  $t_d \cdot c = d_1$ , where  $c =$  velocity of light). It is thus determined that the ship is somewhere on a circle of radius  $d_1$ . If one receives another time signal from  $T_2$ , whose coordinates are also known, such information would also place the ship on another circle of radius  $d_2$ , either at point A or B, the intersection points of the two circles. Such a position ambiguity could be resolved by other navigation means or by measuring a time signal from a third transmitter of known coordinates.

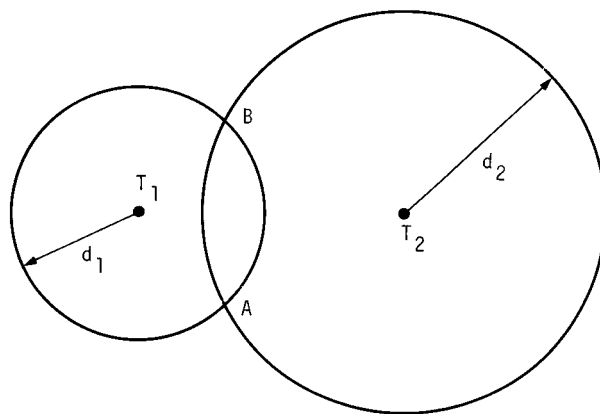

FIGURE 10.14. Concept of range-range navigation.

A corollary to this example is the use of navigation systems for time and frequency dissemination; it would be necessary that the signal format generator be frequency stabilized and that some recognizable character within the format be synchronized with the time tick. The accuracy of ranging and timing capability of some systems are graphed in figure 10.15.

Characteristics of some navigation systems useful for TFD are given in Annex 10.D. The following subsections give details of the radio navigation systems; Omega, Loran-C and Loran-A.

*(1) Omega Navigation System for TFD*

This system was originally conceived as a VLF radio navigation system for ships, submerged submarines, and aircraft [87, 88]. It is expected that both civilian and military craft of many nations eventually

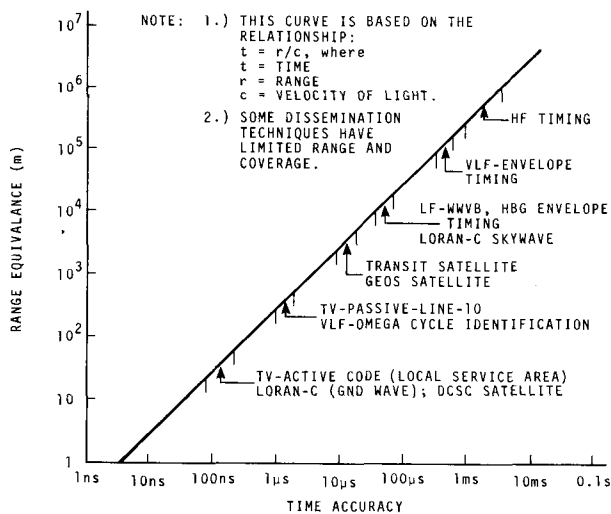

FIGURE 10.15. Relationships between ranging (navigation) and timing (clock) accuracy.

will navigate by Omega. For the past decade the system has been operating experimentally, using only four of the proposed eight transmitters broadcasting at low power and showing potential in both navigation and timekeeping [89, 90]. On October 1, 1968 the U.S. Defense Department approved an eight-station, 10-kW, Omega system with an operational target date in early 1970. (Now scheduled for the mid-1970's.) System implementation will involve capital expenditures of about \$100 million. Four cesium beam clocks will be installed at each of the eight transmitting stations. The eight-station system will provide reliable and near-global coverage. Figure 10.16 gives the proposed worldwide location of the eight-station network. (The Omega station at La Moure, North Dakota (USA) is now operational at full power.)

In the Omega system, each transmitter broadcasts several time-shared carrier frequencies between 10 and 14 kHz. The primary navigation frequency is 10.2 kHz. The basic Omega pattern consists of an eight-element 10-second format, within which the fundamental signals are of about 1-second duration [59] (see fig. 10.17 as an example of one proposed format). At a receiver, phase differences between 10.2-kHz signals from pairs of transmitters define hyperbolic lines of position. Since the observed phase differences of one frequency as received from two transmitters show multiple ambiguities (repeat at intervals of one-half wave length—about 29 km at 10.2 kHz) submultiple frequencies are employed in stages to permit observer location or so-called lane identification (equivalent to cycle identification in the timekeeping sense). Stated accuracies are about 1 km in the daytime and double that at night, and the VLF Omega frequencies can be received adequately at ranges up to about 13,000 km. After an initial fix (and barring unforeseen instrumental or transmitter difficulties), a ship's receiver system will automatically keep track of lane position while the ship is underway. Although the Omega signals are sensitive to propagation vagaries such as diurnal variations, solar activity, and polar cap attenuation [91], compensating factors such as the provision of multiple frequencies can overcome many of these degrading influences.

Conversely, in terms of TFD, frequency comparisons via Omega signals can be made now to a few parts in  $10^{11}$  per day with commercially available equipment; extraction of timing information is similar to VLF techniques previously described. Daily phase values of currently-operating Omega transmissions are published weekly in terms of UTC (USNO) [43]. In this way corrections can be made after the fact. With the new Omega system, it is anticipated that one can continuously maintain phase to 3  $\mu$ s or less per day and/or make frequency comparisons to several parts in  $10^{12}$  at global distances [59]. Lead-edge envelope timing measurements can be made with a precision of about 100  $\mu$ s

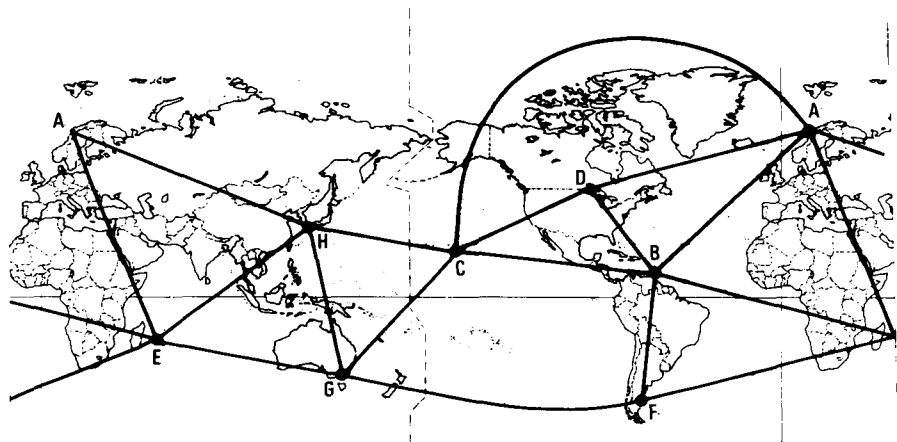

FIGURE 10.16. Proposed worldwide location of eight-station navigation Omega (VLF) network [59].

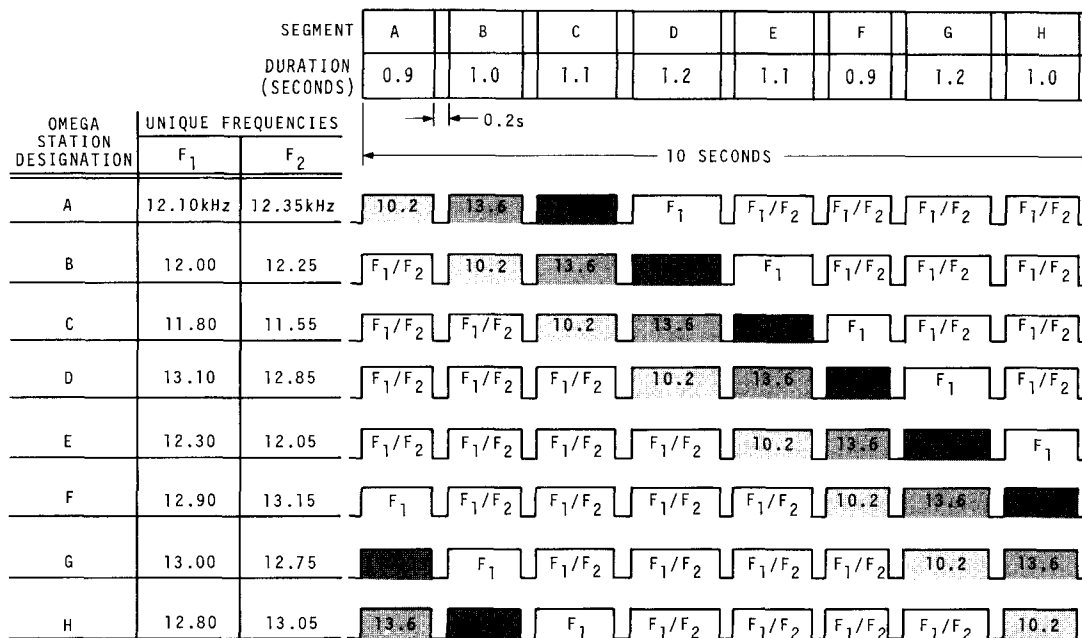

FIGURE 10.17. Proposed Omega eight-element 10-second format [92].

[59]. Since the phases of all the transmitted frequencies are closely synchronized, there is opportunity to employ the multiple VLF carrier technique such as NBS used with the WWVL broadcasts [46]. This method should resolve the basic timing ambiguities inherent in VLF techniques and permit identification of a specific cycle, thus allowing resynchronization of remote clocks. An experimental Omega precise timing receiver has been developed recently and is now being evaluated [92]. The Omega format also offers an excellent opportunity for disseminating time information such as day/hours/minutes in a low-bit-rate time code using two unique frequencies assigned to each station [93]. Such timing would not be required in the navigation function; it does, however, illustrate the significant potential of operational systems providing alternate functions to diverse user groups at negligible cost and inconvenience.

Civilian direction of the operational Omega system will be under the Department of Transportation (DOT) with control of non-U.S. stations provided by the foreign country furnishing the transmitter site. Such an arrangement, subject to international agreement, should insure some degree of permanency and reliability to both civilian and military users.

#### Advantages of the Omega system for TFD

- Transmitted frequencies of each station are based on consensus of four commercial cesium beam standards, and assure both reliability and stability of the Omega transmitted signals.
- The eight-station network will be synchronized to about 1  $\mu$ s and can provide VLF signals from 3 to 5 separate stations to global receiving sites.

- Day to day phase maintenance of several  $\mu$ s appears feasible with corresponding frequency measurements to several parts in  $10^{12}$ .
- System offers a strong potential for disseminating a time code at small additional costs.
- Nearly continuous operation of 24h/day.
- Some propagation factors are predictable, and time is traceable to UTC(USNO) through U.S. Naval Observatory monitoring and reporting.
- Omega system has potential for providing simultaneous timing and navigation information without interference to either.

#### Limitations of Omega TFD include the following:

- Repeated measurements at various frequencies or an external time source may be required to initially set the date or periodically verify coarse time.
- Modal or long-path/short-path interference can adversely affect reception, especially at critical ranges.
- Stable phase periods are generally restricted to certain times of the day, and the VLF signals are subject to degradation in accuracy from propagation factors, such as SID's, diurnal effects, SPA's, etc. (see VLF limitations—sec. 10.3.2.b.)
- The Q of the transmitter antenna limits the accuracy to which pulse transmission can be accomplished at VLF.

#### (2) Loran-C Navigation System for TFD

Loran-C (Long Range Navigation) is a navigation system which evolved from World War II

technology to provide precise position for ships, submarines, and aircraft. In the early 1960's NBS explored the timing potential of this navigation system and found encouraging results [94, 95]. Since then many studies have verified its usefulness for timekeeping [96-98].

Loran-C uses an LF 100-kHz carrier frequency (20 kHz bandwidth) and pulse transmission to form hyperbolic lines of position. The U.S. Coast Guard now operates and manages the system with close synchronization to the U.S. Naval Observatory time scale [UTC(USNO)]. The basic Loran-C unit is a chain, consisting of a master station and two or more slave stations located within ground-wave range of the master transmitter. There are now eight worldwide chains in operation, which, together with slave stations, comprise a total of about 34 stations. These stations are listed in table 10.2. Note that four chains, with details given in

Annex 10.D, are time synchronized and phase controlled within  $\pm 15 \mu\text{s}$  of UTC(USNO). The other four chains employ Cs standards for frequency control but are not maintained within the limits of  $\pm 15 \mu\text{s}$  of UTC. Synchronization of stations within a chain is held usually within  $\pm 0.2 \mu\text{s}$ . The coverage of the multicontinental Loran-C system is shown in figure 10.18.

Loran-C uses a pulse-coded format with rates assigned to (a) separate and identify chains and its members, (b) eliminate stray interference that is coherent, and (c) provide the optimum SNR for given geographic chain coverage. Pulse transmissions enable users to separate multipath (skywave) signals from the earlier arriving and more stable groundwave signals. Within a chain, a master station transmits exactly spaced groups of nine pulses and slave stations eight pulses, within the Group Repetition Period (GRP) assigned to the particular chains.

TABLE 10.2. Characteristics of Loran-C stations

Chain	Rate	Stations	Emission Delay ( $\mu\text{s}$ )	Power (kW)
U.S. East Coast	SS7	M Carolina Beach, NC.....		1,000
		W Jupiter, FL.....	13,695.48	400
		X Cape Race, NF.....	36,389.56	2,500
		Y Nantucket Is., MA.....	52,541.27	400
		Z Dana, IN.....	68,560.68	400
Mediterranean	SL1	M Simeri Crichi, Italy.....		300
		X Lampedusa, Italy.....	*12,757.12	400
		Y Targabarun, Turkey.....	32,273.28	300
		Z Estartit, Spain.....	50,999.68	300
Norwegian Sea	SL3	M Ejde, Faroe Is.....		400
		W Sylt, Germany.....	30,065.69	400
		X Bo, Norway.....	15,048.16	300
		Y Sandur, Iceland.....	48,944.47	1,500
Z Jan Mayen, Norway.....	63,216.20	300		
North Atlantic	SL7	M Angissoq, Greenland.....		500
		W Sandur, Iceland.....	15,068.10	1,500
		X Ejde, Faroe Is.....	27,803.80	400
		Z Cape Race, NF.....	48,212.80	2,500
North Pacific	SH7	M St. Paul, Pribiloff Is.....		400
		X Attu, AK.....	14,875.30	400
		Y Port Clarence, AK.....	31,069.07	1,800
		Z Sitkinak, AK.....	45,284.39	400
Central Pacific	S1	M Johnston Is.....		400
		X Upolo Pt., HI.....	15,972.44	400
		Y Kure, Midway Islands.....	34,253.02	400
Northwest Pacific	SS3	M Iwo Jima, Bonin Islands.....		3,000
		W Marcus Island.....	15,283.94	3,000
		X Hokkaido, Japan.....	36,684.70	400
		Y Gesashi, Okinawa.....	59,463.34	400
		Z Yap, Caroline Islands.....	80,746.78	3,000
Southeast Asia	SH3	M Sattahip, Thailand.....		400
		X Lampang, Thailand.....	13,182.87	400
		Y Con Son, South Vietnam.....	29,522.12	400
		Z Tan My, South Vietnam.....	43,807.30	400

\*Approximate value, station operation scheduled to begin fall, 1972.

LORAN-C COVERAGE DIAGRAM

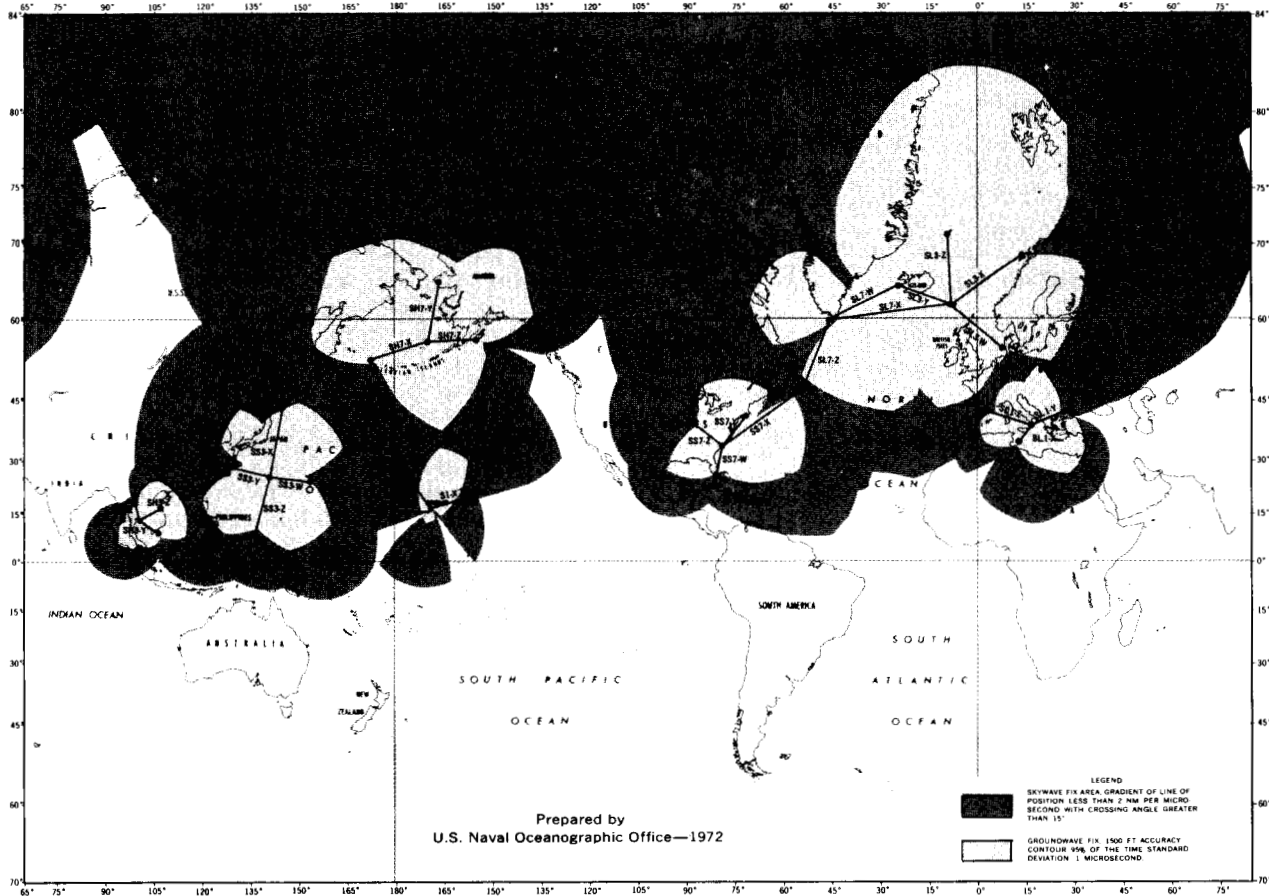

FIGURE 10.18. Coverage of Loran-C navigation system.

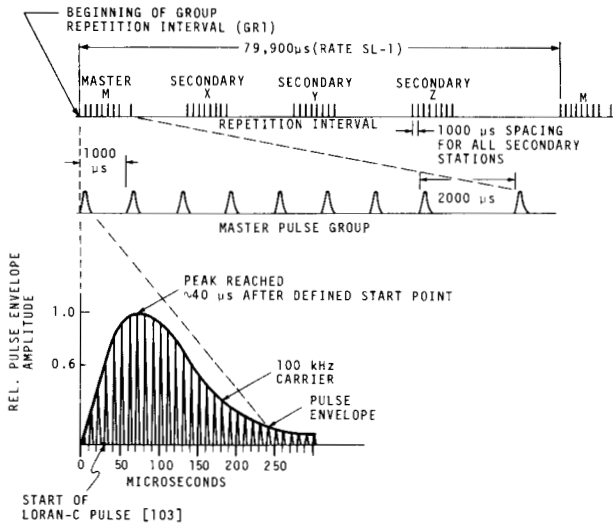

FIGURE 10.19. Loran-C pulse group format.

The Loran-C pulse group format is shown in figure 10.19. This figure also shows a typical pulse with a rise time near  $30 \mu\text{s}$  (following first 3 cycles) for reaching about 60 percent of peak value; a feature permitted by the relatively wide bandwidth of  $\pm 20 \text{ kHz}$ .

For timing it is important to know the time of coincidence (TOC) of Loran-C signals relative to a universal time second on the UTC scale. Since these signals are transmitted by each station once during the GRP, only a particular pulse coincides with the UTC second, followed by periodic coincidence. Times of coincidence vary for the different rates; for example a repetition period of  $59,600 \mu\text{s}$  gives a coincident interval of 149 whole seconds, whereas a rate of  $49,600 \mu\text{s}$  repeats every 30 s. The basic rates and specific times of coincidence for Loran-C signals are shown in table 10.3. Generally, a Loran-C pulse coincides with a UTC second at least once after each 10,000 repetition periods [98]. The USNO devised a null ephemeris table which provides specific coincidences for the master Loran chains in operation. Coincidence measurements using slave



TABLE 10.3.a. *Loran-C basic and specific rates*<sup>1</sup>

Specific	Basic→S	SH	SL	SS
0	50,000	60,000	80,000	100,000
1	49,900	59,900	79,900	99,900
2	49,800	59,800	79,800	99,800
3	49,700	59,700	79,700	99,700
4	49,600	59,600	79,600	99,600
5	49,500	59,500	79,500	99,500
6	49,400	59,400	79,400	99,400
7	49,300	59,300	79,300	99,300

<sup>1</sup> Pulse group repetition interval— $\mu$ s.

TABLE 10.3.b. *Period of time between UTS<sup>2</sup> and Loran rate coincidences (seconds)*

Specific	Basic→S	SH	SL	SS
0	1	3	2	1
1	499	599	799	999
2	249	299	399	499
3	497	597	797	997
4	31	149	199	249
5	99	119	159	199
6	247	297	397	497
7	493	593	793	993

<sup>2</sup> UTS=Universal Time Second or UTC second.

stations must account for corresponding emission delays. The initial date (epoch) for all Loran-C master stations has been set arbitrarily at 00<sup>h</sup>00<sup>m</sup>00<sup>s</sup>, 1 January 1958. The USNO publishes the periodic coincidence from this origin in null ephemeris tables for each calendar year in the Series 9 of the Time Service Announcements [99].

The accuracy of timekeeping via Loran-C depends upon (a) the propagation delay and its variation between the transmitter and receiving antenna, (b) the delay through receiving equipment, and (c) operator skill in cycle selection. (The daily relative phase values are published by the USNO [43] and corrections can be made later.) In addition, synchronizations should be made at TOC seconds and time of the local clock must be known to better than one-half of the period of the appropriate chain repetition rate to eliminate GRP ambiguity ( $\sim 25$  to 50 ms).

The propagation delays depend upon such factors as all sea-water paths, mixed land and sea-water paths, groundwave or skywave propagation, and irregular terrain effects. Propagation delays can be computed using methods devised by Jöhler [100], Jöhler and Berry [101], and Wieder [102], with fair success. Potts and Wieder [103] point out that a single portable clock visit to a user site can calibrate propagation delay for skywave propagation and reduce the error to within an order of magnitude of that observed in groundwaves. If signals are embedded in noise, special procedures are required to enhance the Loran-C pulses. Stetina and Zufall give useful details for obtaining time synchronization of remote clocks from Loran-C signals [98]. Their report pre-

sents a description of Loran-C techniques for clock synchronization of the Manned Space Flight Network (MSFN) and illustrates use of the USNO Time of Coincidence (TOC) charts.

Pakos [97] has assessed the various errors involved in Loran-C timing and has devised some qualitative error budgets for different categories of synchronization; e.g., synchronizing to the same Loran-C station, two stations within a chain, stations in different chains, or "real" time or "after the fact" synchronization. Based on such estimates he obtains an rms error of about 0.35  $\mu$ s for two users within groundwave distance of the same station, wishing to synchronize with each other but not with the UTC time scale. Typically, much larger errors occur when synchronizing to stations in different chains. Shapiro [104] reports microsecond timing capability for Loran-C signals received at groundwave ranges of 1500 km landward and at twice this range over water. (The groundwave range is limited or effected by transmitter power, ground conductivity, noise, interference and signal averaging time.)

Users outside the normal groundwave range of the LF Loran-C signals can obtain useful timing information from skywave propagation but at reduced accuracy. Stone [105] has reported skywave synchronization accuracies at night of  $\pm 50$   $\mu$ s over mixed land and sea paths of 8000-km length. (This experiment was a visual technique requiring synchronous detection.) Doherty [106] has shown carrier phase stabilities of  $\pm 1$  and  $\pm 4$   $\mu$ s for daytime and nighttime, respectively, at ranges to 3200 km for single hop skywaves. Mazur recently reported time synchronization to better than 25  $\mu$ s using nighttime skyway reception of Loran-C at distances of  $\sim 15,400$  km [107]. He points out that such results are demanding of both receiver performance and operator technique.

#### *Advantages of Loran-C for TFD*

- A fully operational system with firm implementation plans for equal status chains (i.e., UTC synchronization) will provide coverage to a large percentage of the world.
- Redundant cesium frequency standards are used for frequency and time control with monitoring and referencing to USNO(UTC) in most cases; phase corrections for six chains are published weekly by the USNO.
- Groundwave stability of Loran-C signals show microsecond precision capability with accuracies limited to about a  $\mu$ s because of propagation effects. Skywave capabilities, depending upon hops, can give  $\pm 10$ -50- $\mu$ s synchronization accuracy. TOC for time coordinated chains are published in advance by USNO.
- Depending upon user requirements, equipment costs are reasonable but increase as timing needs become more stringent.
- The accuracy and stability of the Loran-C

system enable comparison of frequency standards and time scales of many nations and provide a highly rated input to the International Atomic Time (TAI) scale at the BIH in France.

- As with the Omega system, timing and navigational functions can coexist in one system with minimum interference, thus conserving electromagnetic spectrum.

#### *Limitations of Loran-C for TFD*

- The timing accuracies are limited to how well both propagation and equipment delays can be determined. Mixed ground and land paths, coupled with terrain effects, can limit accuracy.
- The local clock time must be known to better than half the chain repetition period to eliminate GRP ambiguity.
- Cycle selection is difficult and requires high operator skill.
- Coverage is not global and many areas in the southern Hemisphere are unable to receive Loran-C signals.

#### *(3) Loran-A Navigation System for TFD*

Loran-A is an MF radio navigation system, developed during World War II, to operate in the frequency range of 1.750 to 1.950 MHz [108, 109]. In this frequency range, coverage is limited to a typical station service area of radius 1800 km (groundwave range over land is reduced considerably); however, installations are worldwide (essentially in the northern Hemisphere) and are located at or near coastal areas. Some 60 pairs of Loran-A stations border the Atlantic and Pacific Oceans. Figure 10.20 gives a projected coverage map for the wide spread Loran-A stations. The U.S. Coast Guard maintains operation of the system, and it is used extensively for navigational purposes. Within certain restrictions, Loran-A is capable of microsecond relative timing or synchronization within moderate coverage areas of particular stations [2].

Loran-A stations operate in pairs using pulse transmissions on three frequency channels as follows:

Channel 1	1.950 MHz
Channel 2	1.850 MHz
Channel 3	1.900 MHz

Specific pulse repetition rates (PRR) are assigned a given Loran-A pair and each station transmits one pulse per Loran-A sequence [2]. The three basic repetition rate are 20, 25, and  $33\frac{1}{3}$  pulses per second coded as S, L, and H respectively. Repetition periods for given PRR's are coded zero through seven; each integer represents 100 microseconds to be subtracted from the basic repetition period of  $\sim 40,000\ \mu\text{s}$ . Thus a Loran-A pair is designated by frequency channel, pulse repetition rate, and specific repetition period; e.g., 1S4 denotes a pair oper-

ating on the Channel 1 frequency (1.950 MHz), a PRR of 20 pulses per second and a specific repetition period of  $39,500\ \mu\text{s}$ . Pulses from two transmitters of a Loran-A pair are radiated with a fixed delay to ensure identification of the master and slave signals within the coverage areas. Baselines of Loran-A pairs range from about 300 to 1200 km and specific repetition rates are chosen to minimize interference from other pairs. Sometimes a third station is provided to form a Loran-triad. This station can operate on both specific repetition rates and perform mixed functions. The Loran-A pulse envelope has a cosine square shape; the pulse envelope rise time at the 50 percent amplitude point is about  $20\ \mu\text{s}$  and the width at this point is about  $40\ \mu\text{s}$ . A typical Loran-A pulse is shown in figure 10.21.

Limited clock synchronization via Loran-A is feasible. Since each pair transmits independently, synchronization can be accomplished only within the coverage area of a particular pair. There is no UTC time base for Loran-A stations; each pair has its independent time base. Reception of these sky signals is limited by propagation effects [110]. Propagation of these MF signals over land paths is extremely limited. The groundwave signal strength of a 100-kW transmitter at 2 MHz received over an  $\sim 200$ -km land path is about equivalent to that received over a 1200-km seawater path. On the other hand, the propagation of skywave signals is about equivalent for water and land paths. Skywave signals, via one-hop E-nighttime transmissions, are usable to about 2500 km, but with reduced accuracy. The ambient noise level experienced at MF also effects the usable range of Loran-A. A typical signal level of  $5\ \mu\text{V/m}$  is required during the day in the middle latitudes to provide a maximum range of about 1200 km.

#### *Advantages of Loran-A for TFD*

- The system provides a means for synchronization to several  $\mu\text{s}$  within coverage range of pairs of stations (in the sense of a transfer standard) within groundwave proximity to the transmitters. Synchronization to  $5\ \mu\text{s}$  is claimed for nighttime skywaves received in an area of over 3000-km radius about the transmitter [2].
- Ultimate system precision, through application of corrections for propagation effects, is predicted at  $0.1\ \mu\text{s}$  over seawater [110].
- Receiving equipment and antenna requirements are minimal, however, commercial Loran-A receiving systems are not available solely for purposes of T/F comparison.
- System employs many worldwide stations in northern hemisphere with signals available to many coastal areas.
- All Loran-A transmitters are accurately located to within about 30 m (equivalent to less than  $0.1\ \mu\text{s}$  error).

# LORAN-A COVERAGE DIAGRAM

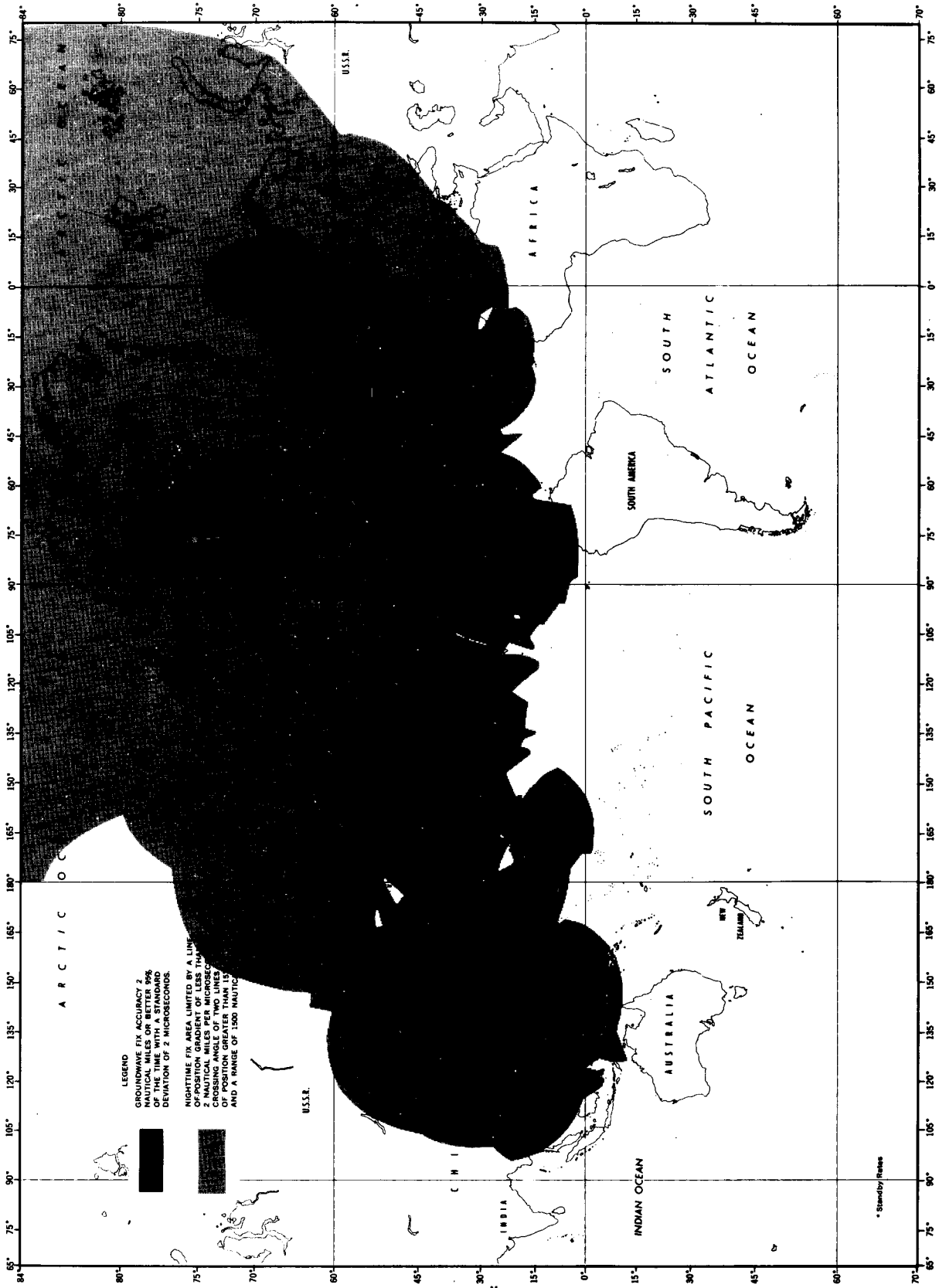

FIGURE 10.20. Coverage diagram of Loran-A navigation stations.

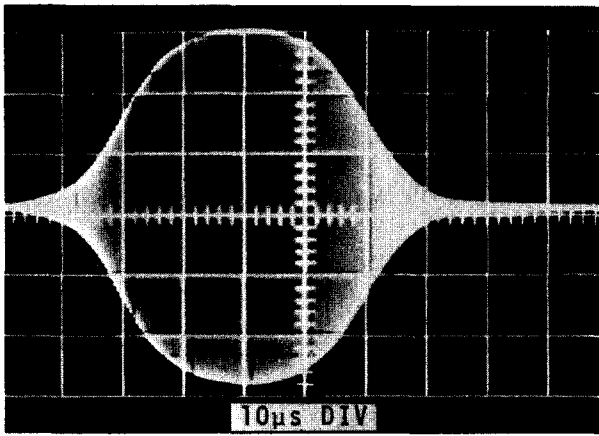

FIGURE 10.21. Typical Loran-A pulse envelope.

#### *Disadvantages of Loran-A for TFD*

- Pairs of stations in the Loran-A network are not linked together in time and repetition rates; they have no relation to the UTC time scale and are essentially 60 independent broadcasting systems.
- The area over which Loran-A time measurements could be made is limited to that in which signals from either of a pair of Loran-A transmitters can be received.
- Frequency generators are crystal oscillators which show aging effects relative to time; phase corrections are not published.
- Reception of Loran-A signals is limited to relatively short ranges and is subject to fluctuations inherent in MF propagation.
- The altitude of a receiving site above the surface is a factor that must be corrected for in precise time measurement; i.e. in an aircraft.
- Range of transmission coverage is affected by ambient noise level and is related to location on the earth, season, and day or night transmission.
- Land masses in the course of signal path adversely affect propagation.

#### **f. Television TFD Techniques**

Time and frequency comparisons via television signals have become a valuable and useful technique in many countries during the past 5 or 6 years [111–120]. Tolman et al., first demonstrated the utility of synchronizing remotely located clocks with television pulses transmitted over many microwave links; VHF television signals from one transmitter also provided clock synchronization to the same accuracy within the local TV broadcast service area [111]. A primary concern in long-term TV comparisons is the constancy of the propagation path delay between a multiplicity of microwave relays. Many studies have substantiated that such

path stability is in the range of 0.1 to 1.0  $\mu\text{s}$  [112, 113, 116, 119]. For “on time” synchronization it is necessary to know the propagation path delay between the transmitter and receiver. This can be calibrated by a portable clock visit. Tolman et al., [111] reported that measured path delays agreed well with calculated values based on geographical distances and assumption of speed of light propagation. Leschiutta recently compared geographical delay computations for the Rome to Turin path in Italy ( $\sim 745$  km) with both round trip TV measurements and Loran-C data [120]. Geographical delay was determined by an ellipsoid computer program using established coordinates for transmitters, microwave relay stations, and receiving points. The calculated differential path delay agreed with the Loran-C data to less than 1  $\mu\text{s}$  and with the round trip TV values to about 6  $\mu\text{s}$ . Uncertainties in coordinates account for variation in these data. Such computed delays could prove useful to TV clock comparisons, dependent upon the accuracy required.

At this point we will consider the mechanism of various TV techniques for TFD. The following four categories have been investigated and will be discussed in terms of experience in the U.S.:

- (1) Time dissemination. TV transmissions can be utilized without auxiliary coding as a “transfer standard” (passive) for clock coordination [111, 112, 117].
- (2) Time and frequency dissemination. Sync pulse trains can be stabilized in frequency, then aligned in some fashion with a time scale [121].
- (3) Frequency dissemination. Frequencies contained in the TV transmission can be stabilized, providing accurate frequency information directly, or they can be used in a “transfer standard” application [116, 122].
- (4) Time and frequency dissemination. Time and frequency information can be injected into unused portions of the TV format for dissemination (active) [116, 119, 123, 124].

(1.a) *Sync Pulse “Transfer Standard” Clock Coordination.* The method was first demonstrated in 1965 when synchronization via TV microwave links was accomplished between Prague, Czechoslovakia and Potsdam, Germany [111]. The method has since gained wide acceptance. In 1968, NBS began using TV sync pulses from a common transmitter to synchronize the time broadcasts from Fort Collins, Colorado, to the UTC(NBS) Time Scale at NBS, Boulder [79]. The accuracy of such measurements is better than 1  $\mu\text{s}$  with an rms day-to-day deviation of about 30 ns.

(1.b) *NBS Line-10 “Transfer Standard” Time Dissemination.* Following the work of Tolman and others, NBS developed the TV line-10 system as a passive means of comparing geographically-separated precision clocks [116, 125]. Figure 10.22 gives

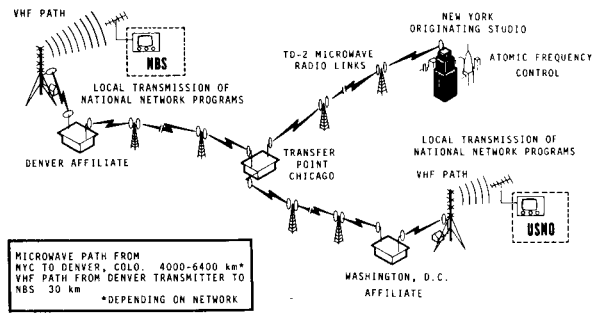

FIGURE 10.22. Overview showing routing of TV signals for time/frequency comparisons.

an overview of the system which permits periodic comparison of clocks throughout the U.S. via commonly received network broadcasts at a specified time. The broadcasts used by NBS originate from the New York City studios of three commercial TV networks (ABC, CBS, and NBC).<sup>3</sup> These originating networks stabilize their transmissions with independent atomic frequency standards (rubidium gas cells). The New York signals, broadcast without auxiliary time coding, traverse varied and long paths using relays at microwave frequencies. This relay system is a chain of broadband radio links encom-

<sup>3</sup> The results of this report are not to be used for advertising or promotional purposes, or to indicate endorsement or disapproval of the product(s) and/or services of any commercial institutions by the National Bureau of Standards.

passing the continental United States at line-of-sight distances of 40 to 60 km between repeaters. The routing of such networks in NBS experiments is shown in figure 10.23. The microwave relay system carrying over 95 percent of intercity television programs is known as the TD-2 system [126]. At a terminating station, such as an affiliate local transmitter, the microwave signal from the applicable repeater station is converted to a video signal and retransmitted by VHF or UHF (commercial TV) to a local service area. Reception points for typical line-10 experiments included the USNO at Washington, DC and NBS at Boulder, CO.

This version of TV timing uses the pulse identifying line-10 of the odd field in the 525-line system M (FCC standard for the U. S. and one of some 12 worldwide system [127]), as a passive transfer pulse. This pulse occurs during the blanking retrace interval between successive fields as shown in figure 10.24. The line-10 pulse, as the *transfer standard* element, is easy to identify with simple logic circuits. Figure 10.25 shows a typical equipment configuration for line-10 clock synchronization at a receiver site. Clock comparison occurs through differential measurements of TV line-10 data. Basic data are taken simultaneously from a common TV broadcast at given receiving sites; the differences between clock-counter output readings remain essentially unchanged within a few microseconds from day to day except for infrequent reroutes of microwave signals and/or instability or relative frequency offsets among the reference clocks [125].

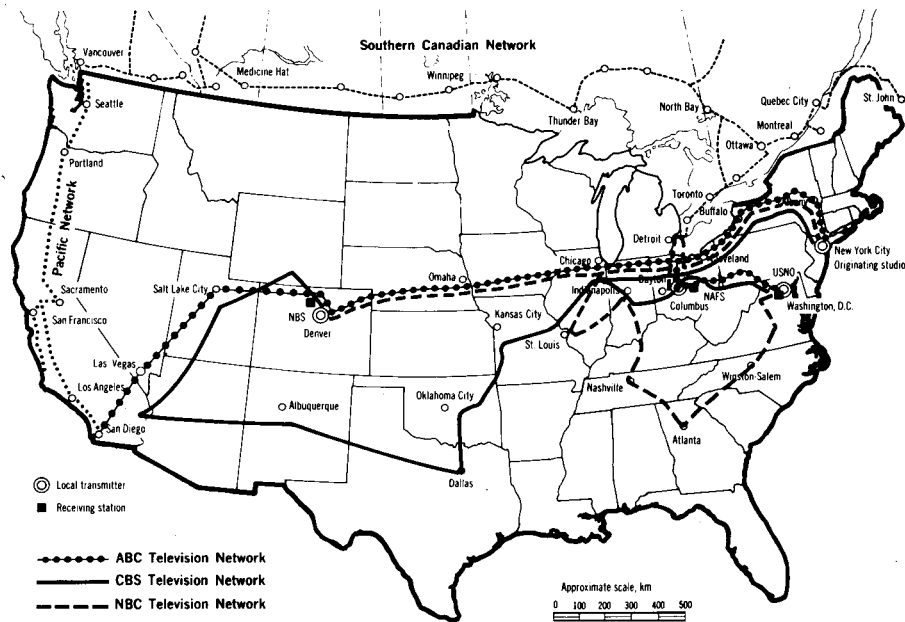

FIGURE 10.23. Microwave relay routing of different networks across continental U.S. used for NBS television experiments.

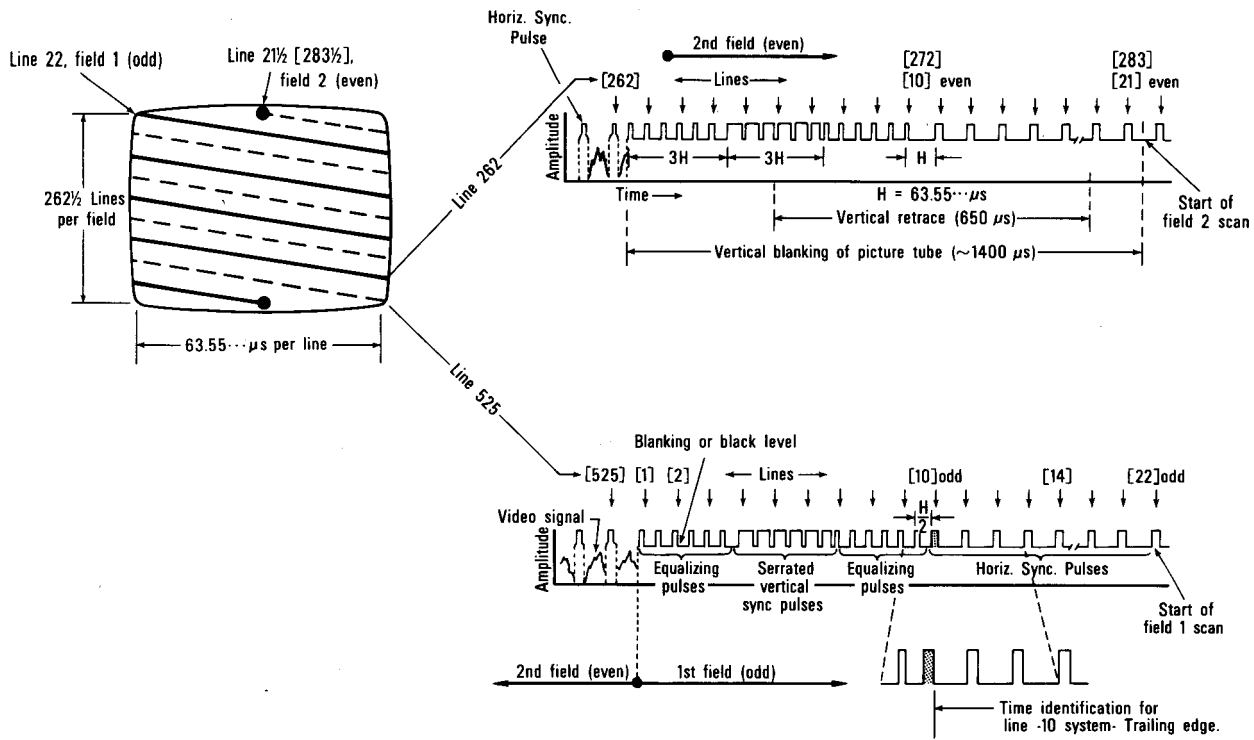

FIGURE 10.24. Pulses in vertical blanking interval of TV format.

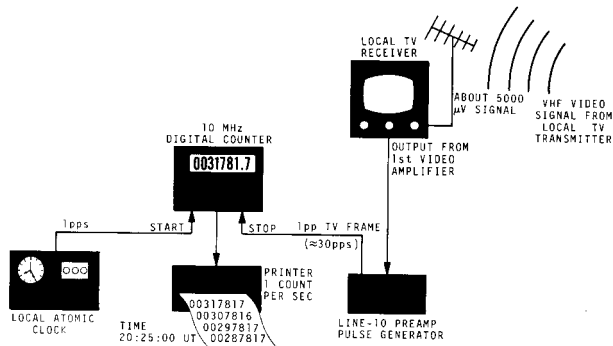

FIGURE 10.25. Typical equipment configuration for line-10 clock synchronization at a receiving site.

Likewise, other clocks in the U.S. can be related to the UTC(USNO) and UTC(NBS) scales through a similar reception and data processing technique. Comparisons can be made with daily line-10 measurements made at the USNO and NBS and published periodically [42, 43]. If the system is to be used to accurately set the clock's date, the delay of the propagation paths involved must be known; e.g., calibrated with a portable clock. Since the period of one TV frame is 33.3 . . . ms, it is also necessary to resolve this ambiguity at the receiving site to ~ 16 ms.

Typical TV signals in the U.S. may be routed over paths two to four thousand kilometers in length. The occasional network reroutes mentioned previously will produce an effective change in the propagation path delay. If the rerouting is not common to all clock comparison links it will adversely affect the results; consequently, it is highly advantageous to use all three networks to enable identification of any such changes in one link.

A detailed analysis was made of TV line-10 data for the period June 1969 to December 1970 [128]. Figure 10.26 gives a plot of fractional frequency stability  $\Delta\sigma_y(\tau)$ <sup>4</sup> versus the sample time  $\tau$  in days for the microwave paths between Washington, DC and Boulder, CO for each of the three networks; the instabilities of the reference time scales are assumed negligible. The time fluctuations were analyzed directly, and it was determined that the TV noise was reasonably modeled with an  $\alpha = 1$  process, i.e., flicker noise phase modulation for this path [129, 130]. The dashed line in figure 10.26 corresponds to a noise process with  $\alpha \geq 1$ . The fractional frequency between AT(USNO)<sup>5</sup> and

<sup>4</sup>The symbols used in Chapter 10 are defined in the glossary in Annex 8.A of Chapter 8.

<sup>5</sup>The designation AT(USNO) parallels our designation AT(NBS); it follows the New Delhi CCIR Recommendation 458 of Study Group 7 for Standard Frequency and Time Signals. USNO (Mean) or A.1 (Mean) in reference [131] is identical to AT(USNO) as used herein.

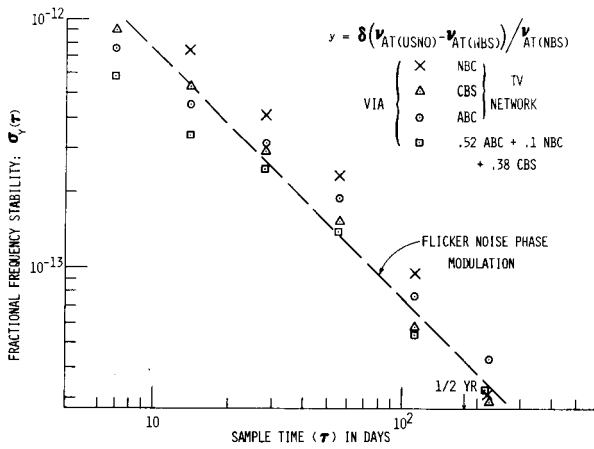

FIGURE 10.26. Fractional frequency stability  $\sigma_y(\tau)$  versus sample time of AT(USNO)-AT(NBS) time scales compared by three-network TV line-10 technique.

AT(NBS) [131, 132] calculated over the period of analysis was:

$$\frac{\nu_{AT(USNO)} - \nu_{AT(NBS)}}{\nu_{AT(NBS)}} = \begin{cases} 4.48 \times 10^{-13} & \text{via ABC} \\ 4.43 \times 10^{-13} & \text{via CBS.} \\ 4.56 \times 10^{-13} & \text{via NBC} \end{cases} \quad (10.1)$$

The precision of these measurements is  $\pm 3 \times 10^{-14}$  as indicated by the stability shown at  $\tau = 224$  days.

The three essentially independent networks enables one to optimally combine the data by weighting each network set inversely proportional to its variance. The squares in figure 10.26 represent the combined network stability using such an optimum weighting procedure. Figure 10.27 gives a

plot of relative time differences (average rate removed) of the AT(NBS)-AT(USNO) time scales for the 1969-71 test period in terms of three-network TV line-10 (weighted), Loran-C, and cesium portable clocks. Good agreement is shown with portable clock measurements, and the maximum spread is well within  $\pm 2 \mu\text{s}$ . The results of the TV line-10 study indicated that this three-network TV system (properly filtered) could be used in major portions of the United States to maintain clock synchronization within an RMS precision of about:

$$\tau \sigma_y(\tau) = 5 \text{ ns } \tau^{1/3} \text{ s}^{-1/3}, \quad (10.2)$$

where  $\tau$  ranges from 86400 s to about  $2 \times 10^7$  s (1 to 224 days). Equation (10.2) is based on the assumption that the clocks were synchronized previously [128].

(2) *Real Time Synchronization from Stabilized TV Sync Pulses.* The USNO recently proposed a modification of the TV line-10 passive time synchronization technique [121]; in this method the TV color subcarrier frequency (3.57 . . . MHz) is stabilized with a cesium atomic standard [122] and phase shifted so that sync pulses in the vertical interval coincide with 1-pps signals referenced to the USNO master clock (MC). The method can be used to set remotely located clocks in a TV local service area within several nanoseconds of an absolute time scale. In a particular experiment the USNO stabilized the color subcarrier frequency of a local TV station in the Washington, DC area and maintained coincidence between the line-10 pulse marker (odd field) with a one-second pulse of the USNO-MC. Coincidence occurs at exactly 1001 seconds (16 min 41 s) intervals because of the unique TV frame repetition rate (33.366, 667 ms per frame—see refer-

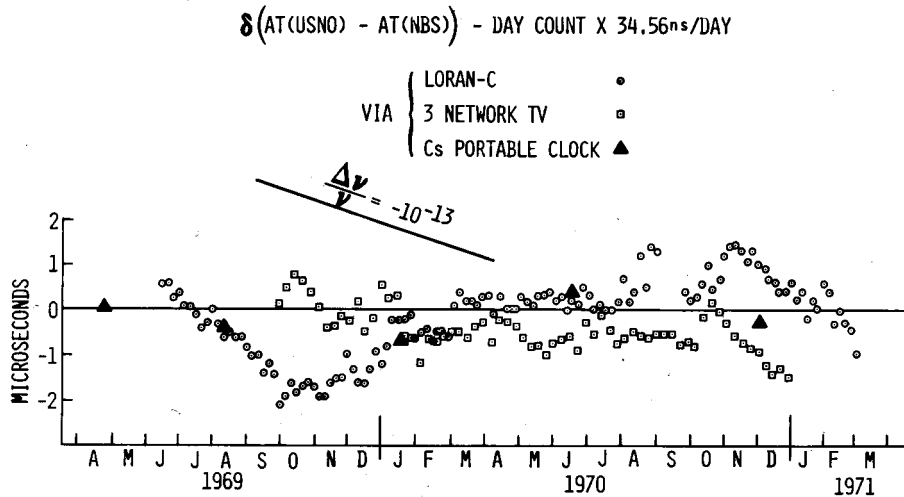

FIGURE 10.27. Relative time differences of the AT(NBS)-AT(USNO) time scales compared by the Loran-C, three-network TV line-10, and cesium portable clock techniques (plus arbitrary constants).

ence [125]). Such a relationship permits calculation of time of coincidence (TOC) dates or times, months in advance, referenced to some arbitrary initial TOC. The USNO has set an initial coincidence as 0000 UT January 1, 1958 and computed 3 time of coincidence Ephemeris Reference Tables similar to those used in Loran-C (see sec. 10.3.2.e(2)). An example of TOC table use for "on time" clock comparison is shown in table 10.4.

The USNO line-10 TV measurements at a receiving site are identical to those discussed previously in the NBS line-10 section. In the USNO experiment [121] the cesium oscillator controlling the local TV transmitter was not maintained in synchronism with the USNO Master Clock; however, over a 2-month period only a small drift of about 1  $\mu$ s was recorded between the two frequency standards. Absolute frequency stabilization of a TV transmission, together with TOC charts, offers an economical and accurate synchronization technique for referencing clocks in local TV service areas at any convenient time and completely independent of contact with the time referencing laboratory.

Certain advantages and limitations of passive television time synchronization techniques are outlined in table 10.5.

(3) *Stabilization of TV Color Subcarrier.* In the U.S. the major TV networks provide a means for precise frequency measurements in their color broadcasts. In such broadcasts a color subcarrier of 63/88 of 5 MHz (3.57 . . . MHz) is derived from a rubidium oscillator/synthesizer (stable to  $\sim 1$  part in  $10^{12}$  per day) at the originating station in New York City and transmitted on each horizontal sync pulse, together with the picture information. It is used as a reference to phase-lock the crystal oscillator in the home color TV receiver for demodulating the chrominance sidebands and maintaining color shades. Frequency stability measurements of the color subcarriers of the three major networks (originating in New York City) have been made at NBS, Boulder, Colorado [122]. The received subcarrier is compared in frequency to the NBS standard, and the networks are advised of their frequency offset so that they can adjust their oscillators. The rubidium oscillator frequencies are measured

TABLE 10.4. Example of using USNO Time of Coincidence (TOC) Ephemeris Reference Tables for frequency stability-TV, line-10 [121]

(a) Assume a clock synchronization was desired at about 1930 UT on September 19, 1971 in a local TV service area. Measurements between the local clock and the received line-10 signals gave the following printout:

h	min	s	
19	30	02	19 987.67 $\mu$ s
19	30	01	18 987.67
19	30	00	17 987.67
19	29	59	16 987.67
19	29	58	15 987.67

(b) TOC table values:

Table 1 First TOC each Day			Table 2 All TOC's per Day			TOC—Sept. 1971 Near 1930 UT (Addition Tables 1 and 2)			Table 3 Interpolation of Seconds Between TOC's		
h	min	s	h	min	s	h	min	s	h	min	s
9/19/71	00	12	26			19	23	35	19 <sup>h</sup>	29 <sup>m</sup>	60 <sup>s</sup>
				near	19	11	09		19	23	35
				1930 UT	19	27	50		19	23	35
					19	44	31		19	23	35
									6	25	

(c)  $\therefore$  The TV line-10 odd pulse following the 19<sup>h</sup>30<sup>m</sup>00<sup>s</sup> UT 1-pps will be transmitted at 19<sup>h</sup>30<sup>m</sup>0.017966.67<sup>s</sup>.

(d) Calculation of clock differences:

Local clock difference with received TV line-10 pulse (19 <sup>h</sup> 30 <sup>m</sup> 00 <sup>s</sup> —September 19, 1971)	17 987.67 $\mu$ s
Propagation time	— 18.00
	<hr/>
	17 969.67
TOC chart time of transmission	— 17 966.67
	<hr/>
Clock difference	3.00 $\mu$ s.

Thus UTC(local clock)—UTC(TV<sub>ref</sub>)=3.00  $\mu$ s (1930 UT September 19, 1971).



TABLE 10.5. *Advantages and limitations of passive television techniques for TFD*

Television Technique	Advantages	Limitations
(1. a) Transfer standard (differential) using a TV sync pulse received in a TV transmitter local service area.	<ol style="list-style-type: none"> <li>1. Precise clock comparisons can be made to better than 100 ns.</li> <li>2. Comparisons can be made at any time during transmission without modification or influence on network programming.</li> <li>3. Method is independent of microwave network routing.</li> <li>4. Comparison equipment at a receiving station is relatively inexpensive.</li> <li>5. Measurement methods are simple.</li> <li>6. Simultaneous clock measurements can be made at an unlimited number of stations within a local service area.</li> </ol>	<ol style="list-style-type: none"> <li>1. Clock readings must be taken simultaneously by timing centers requiring synchronization.</li> <li>2. Data must be exchanged between participating stations after the fact of measurement.</li> <li>3. Technique gives only comparative clock differences. Calibrated path delays between stations is required for absolute time comparison.</li> <li>4. Coverage is limited to line of sight VHF or UHF signals which may be subject to multipath interference within a local TV service area.</li> </ol>
(1. b) Transfer standard (differential) using received TV line-10 throughout continental U.S.	<ol style="list-style-type: none"> <li>1. Precise clock comparisons can be made to about several microseconds nearly anywhere throughout continental U.S.</li> <li>2. Three television networks with atomic clock references (Rb) provide redundancy and enable cross synchronization; system has no effect on network programming.</li> <li>3. The required instrumentation is simple, easy to use, and reasonably inexpensive. (The line-10 pulse code generator costs less than \$200.)</li> <li>4. One-a-day measurements are adequate for precise frequency standards.</li> <li>5. Users can compare TV line-10 measurements with published NBS and USNO values and relate time scales if propagation path is calibrated.</li> <li>6. Modular frame intervals can permit advance predicted TV delays.</li> </ol>	<ol style="list-style-type: none"> <li>1. Microwave paths can be interrupted or networks rerouted without notice.</li> <li>2. Clock readings must be made simultaneously by all stations requiring synchronization.</li> <li>3. Measurements require simultaneous viewing of "live" broadcasts originating from New York City studios for near-continental coverage; present network distribution system uses a delay tie-in with West Coast transmission lines which limits coverage of West Coast area; also there is limited availability of simultaneous viewing of nationwide network programs.</li> <li>4. System will not work with tape delays.</li> <li>5. NBS and USNO measurements are not made on weekends and reference data at these times are unavailable.</li> <li>6. Line-10 TV system ambiguity is ~33 ms.</li> <li>7. Propagation anomalies may limit system's usefulness in some areas of the continental U.S.</li> </ol>
(2) Real time transfer from time-scale-related transmissions (line-10 in local TV service area).	<ol style="list-style-type: none"> <li>1. System can set or synchronize clocks within the local TV service area to a few nanoseconds of a reference clock.</li> <li>2. The stabilized modular frame intervals permit prediction of TOC between 1 pps of an atomic time scale and emitted line-10 odd pulses, months in advance. This allows construction of TOC charts and independent clock synchronizations.</li> <li>3. System will operate with existing line-10 TV receivers.</li> <li>4. Operation is without interference or effect on regular programming.</li> <li>5. Measurement methods are simple.</li> </ol>	<ol style="list-style-type: none"> <li>1. Requires installation of atomic cesium clock and phase shifting synthesizer at local TV transmitter.</li> <li>2. Absolute clock calibrations require knowledge of delay between the transmitter atomic standard and local standard at TV receiving site.</li> <li>3. Clock time must be known to half the system ambiguity or ~16 ms.</li> <li>4. Same as item 4 for technique (1. a) previously given.</li> </ol>

regularly at Boulder in terms of the rate of AT(NBS), and the average weekly data are published for the benefit of users throughout the country [42]; representative data are given in table 10.6. Note the agreement in offset frequency among the three networks during the week of January 22-26, 1973. Such agreement was intentional to permit interchange and split screen synchronization of the three network TV cameras during President Nixon's inauguration; the AT(NBS) scale was used as a common reference for such adjustment. (TV color

subcarrier frequencies are still offset from nominal by about  $-300$  parts in  $10^{10}$ .)

NBS designed instrumentation both to synthesize the output of a 1- or 5-MHz local frequency standard to 3.57 . . . MHz and to compare phases of the local synthesized signals to the received subcarrier frequency [122]. Figure 10.28 gives a block diagram of such a calibration system. Frequency stability measurements of the color subcarriers received at Boulder indicated resolution of the phase difference between the subcarrier and local 3.57 . . . -

TABLE 10.6. U.S. television network atomic standard frequencies in terms of AT(NBS)

Dates of Measurement Period 1973	Average Fractional Frequency Offset (parts in 10 <sup>10</sup> )		
	NBC	CBS	ABC
2 Jan.- 5 Jan.	-302.85	-295.87	-305.18
8 Jan.-12 Jan.	-301.27	-295.85	-305.25
15 Jan.-18 Jan.	-301.21	-295.89	-299.23
22 Jan.-26 Jan.	-299.27	-299.04	-299.37
28 Jan.- 2 Feb.	-299.26	-295.84	-299.36

From NBS Time and Frequency Services Bulletin, February 1973. See reference [42].

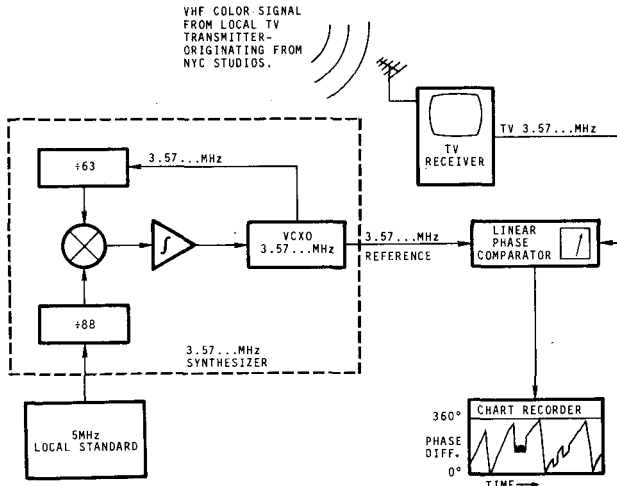

FIGURE 10.28. Equipment configuration for TV color subcarrier frequency comparisons.

MHz signal to less than 10 ns; this corresponds to a frequency resolution of about one part in 10<sup>11</sup> in ~ 17 minutes. A plot of relative fractional frequency stability versus sample time is given for the following data in figure 10.29: CBS TV color subcarrier; weighted three-network TV line-10; cesium portable clock and Loran-C [128]. An estimate of the time dispersion of the color subcarrier data plotted in figure 10.29 is as follows:

$$\tau\sigma_y(\tau) = 0.3\text{ns } \tau^{1/3}\text{s}^{-1/3}, \quad (10.3)$$

with  $\tau$  in the range  $125 \leq \tau \leq 384$  s. The measured frequency stability of the color subcarrier gave a  $\tau\sigma_y(\tau)$  of 1 nanosecond in the range  $1 \mu\text{s} \leq \tau \leq 1$  s. Figure 10.29 permits comparison of relative stabilities (precision) of the several techniques; e.g., at  $\tau = 200$  s the values of  $\sigma_y(\tau)$  for Loran-C, TV color subcarrier, and cesium portable clock are  $1 \times 10^{-10}$ ,  $1 \times 10^{-11}$ , and  $4 \times 10^{-12}$  respectively [128].

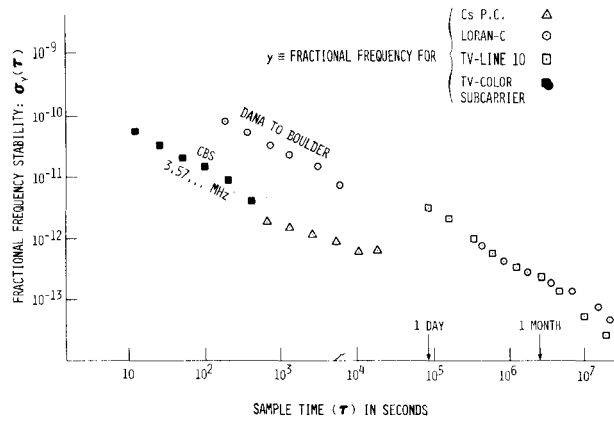

FIGURE 10.29. Relative fractional frequency stability,  $\sigma_y(\tau)$  versus sample time for CBS TV color subcarrier; Loran-C; three-network TV line-10; and cesium portable clock.

Some advantages and limitations of the TV color subcarrier technique (3) of comparing frequency standards are as follows:

#### Advantages

- Provides resolution of frequency differences to about one part in 10<sup>11</sup> in less than 30 minutes; excellent short term stability is shown.
- TV color subcarrier comparisons can be made to the NBS(UTC) time scale through periodically published data [42].
- Comparison equipment is relatively inexpensive and simple to use (parts cost for the 5.0 to 3.57 . . . -MHz synthesizer and linear phase comparator is about \$100).
- The several independent networks allow both flexibility and redundancy of measurement.

#### Limitations

- Requires TV color transmission referenced to atomic frequency standard (originating network in New York City).
- Microwave relay links can fail or be rerouted causing disruption of signal.
- West coast tie-in to "live" programming from New York City is limited and the networks give minimal coverage to West coast areas of the U.S.
- Taped programs with local low grade oscillator control is unsatisfactory for color subcarrier comparisons.
- Propagation anomalies can limit usefulness of TV color subcarrier comparisons in some areas of the U.S.

(4) *Injection of Time and Frequency Information into TV Format (Active).* Techniques for transmitting time and frequency information within the broadcast TV format have been developed at NBS. Initial

tests were made at Denver, CO, using lines 15 to 17 [116]. In January 1971, Koide and Vignone tested the technique on a 45-km path in California and found the synchronization accuracy better than 100 ns [133]. The favorable results experienced in the early tests led to refined experiments across the continental U.S. from New York City to Boulder, CO and to Los Angeles, CA [123, 124]. This active line technique, called the "NBS TV Time System," used line one of the vertical blanking interval for transmission of time and frequency information. Such a proposed time and frequency dissemination system is undergoing evaluation. A section of the system, useful for local area distribution, is shown schematically in figure 10.30. The time and frequency information is injected into line one as shown in the wave form diagram of figure 10.31.

The user station is equipped with a TV receiver, a decoder, an alphanumeric character generator, and optional auxiliary equipment for automatically measuring the time difference between the received time signal and the user's clock. Several modes of operation are available to the user (see fig. 10.30).

(a) Coarse time (hours, minutes, and seconds) can be displayed on demand on the user's TV screen in alphanumeric characters.

(b) The time difference between the received time and the user's clock time can be displayed on the TV screen with nanosecond resolution.

(c) The received 1-MHz sine wave can be used for direct frequency comparison.

*Digital time dissemination:* A reference time standard and a time code generator are installed at the point of program origin (network or local studio). Both the code and its complement are sent for redundancy. The code, injected in the second half of line-1, carries hour-minute-second (HMS) information derived from the reference time standard (see fig. 10.31). The system does not measure propagation delay time; this delay is treated as clock error, which is insignificant for coarse timing. The user must make a calibration of the path delay between the clock at the code injection point and the clock at the receiver if accurate time is desired.

At the user's clock station a decoder is required. Optional comparison instrumentation is available if desired. The active line system provides an HMS readout on a modified commercial TV receiver, which includes a built-in digital clock regulated by the time code. In the event no code is received, the digital clock reverts to internal control.

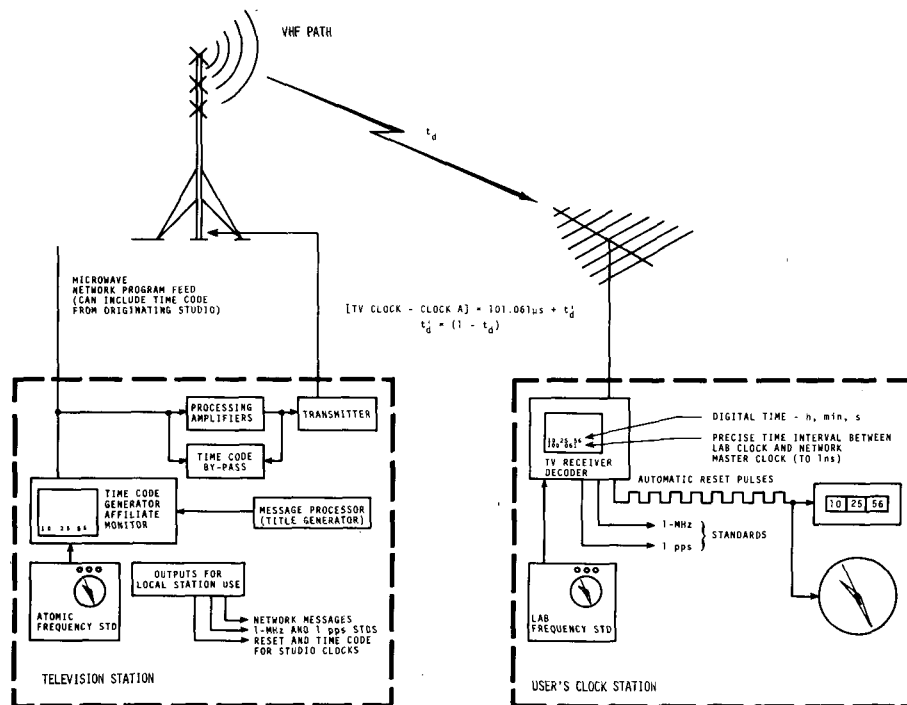

FIGURE 10.30. Active-line TV Time system at local television station.

**1-MHz frequency dissemination:** The active line system also provides a precise frequency standard. A stable 1-MHz carrier is transmitted during the interval between the first and second equalizing pulses of lines 1 and 262½ (see fig. 10.31). At the decoder, a phase-locked oscillator recovers this signal using an approach similar to the detection of the color subcarrier in a color TV receiver. Results at NBS indicate that such a received standard frequency permits calibration of a local standard to 1 part in  $10^{11}$  in less than ½ h.

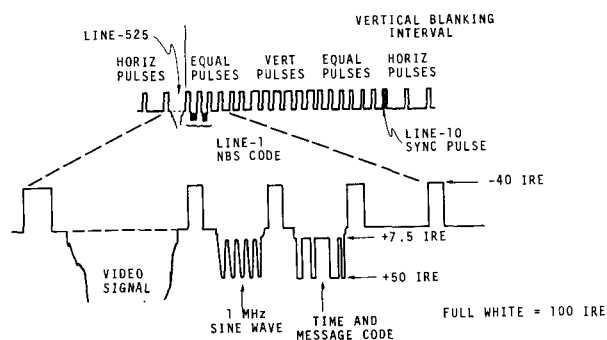

FIGURE 10.31. Method of injecting time-frequency information on active line in vertical blanking interval.

The reported active line-1 experiment compared a cesium reference 1-MHz signal at NBS Boulder to a TV line-1 received 1-MHz signal generated by a cesium standard at the ABC New York City studio [123, 124]; typical phase variations of about  $\pm 10$  ns were shown in one hour as indicated by a comparison record given in figure 10.32. The short term stability of a 1-MHz quartz oscillator, phase locked to the received 1-MHz TV signal originating at New York City, was determined; measurements indicated that this active line-1 data were only slightly less stable than the color subcarrier data except for measurement times  $< \sim 20$  ms [124]. This is noteworthy, in that the line-1 system is sampled at about 1/100 the rate as that for the color subcarrier. Figure 10.33 is a block diagram which shows the capability of phase-locking a local crystal oscillator to a received 1-MHz signal from an active TV line. This TV system shows a long term (several days) stability of a few parts in  $10^{12}$ . (It should be noted that the Department of Commerce petitioned the FCC in December 1972 for the use of line 21 in the vertical interval for time and frequency dissemination similar to the line-1 active system.)

Capabilities and limitations of the active line TV dissemination of time and frequency are listed in table 10.7.

TABLE 10.7. Capabilities and limitations of active line TV time/frequency dissemination (category 4)

Television Technique	Capability	Limitations
Time and frequency coding of active line in Blanking Interval.	<ol style="list-style-type: none"> <li>1. System permits calibration and phase-locking of remote oscillator to about 1 part in <math>10^{11}</math> within ½ h.</li> <li>2. System can transfer real time to submicrosecond accuracy in a local service area; provides hrs., min., and seconds in continuous digital update.</li> <li>3. It is estimated that 70% of the U.S. population could be reached by installing synchronized coders at network centers in New York City and distributing the active code over existing microwave links.</li> <li>4. Transmission of data has no effect on network programming and system transmission is cost free to user.</li> <li>5. As the UTC scales of both NBS and USNO are mutually coordinated to <math>\sim \pm 5 \mu\text{s}</math> of each other, users of TV active line system would have effective access to both scales.</li> <li>6. User cost is proportional to required precision.</li> <li>7. System is unambiguous to 24 h for date information, and reliability to <math>10 \mu\text{s}</math>.</li> <li>8. Three or four major networks would provide redundancy and permit cross checking.</li> <li>9. System supports other uses such as captioning for the hearing impaired.</li> </ol>	<ol style="list-style-type: none"> <li>1. Requires installation of cesium standard and encoders at TV transmitters. (A time and frequency decoder, capable of nanosecond resolution, would cost about \$1000.)</li> <li>2. Clock decoder must be installed at clock comparison receiving station.</li> <li>3. Microwave paths can be interrupted or networks rerouted without notice.</li> <li>4. Equipment requires modification to allow time code compatibility with local time in case of taped shows.</li> <li>5. The viewing time of nationwide network programs is limited; the active line must be "live" for measurements referred to the network cesium beam standard.</li> <li>6. Real time comparisons require knowledge of propagation and equipment delay time between the transmitter atomic standard and the frequency standard at the receiver.</li> </ol>

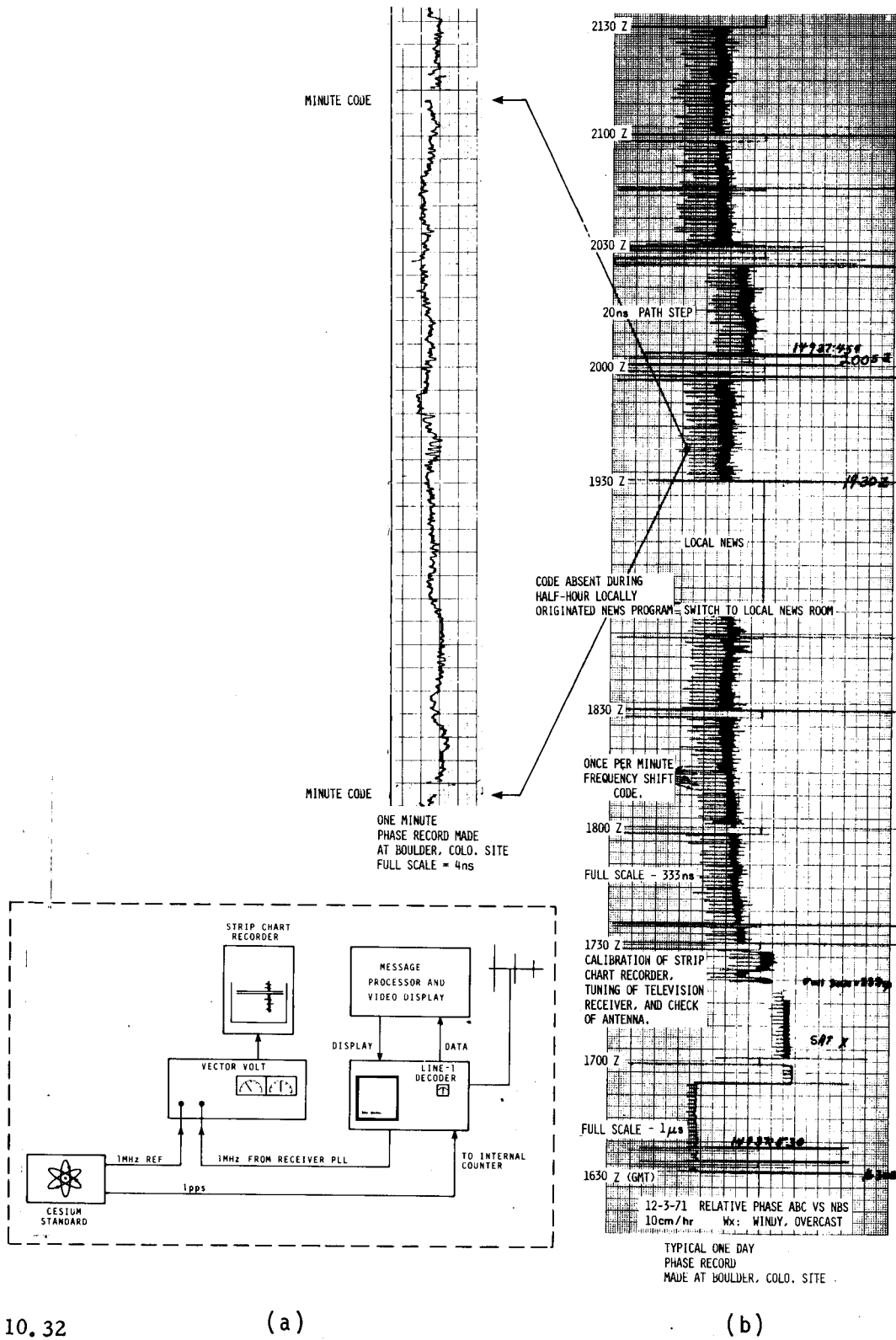

10.32 (a) Typical equipment configuration for phase versus time measurements (TV); (b) phase record comparing 1-MHz signal from cesium standard at Boulder, CO with 1-MHz signal derived from line-1 active code generated from cesium standard at New York City studio.

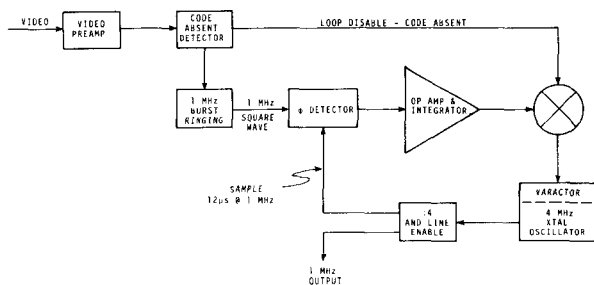

FIGURE 10.33. Phase locked crystal oscillator via TV line-1 (1-MHz reference signal).

#### g. TFD via Earth Satellites

The appearance of Sputnik satellites in 1957 signalled a new potential in terrestrial-space radio techniques. Since then, artificial earth satellites have been proposed and used for a variety of purposes including telecommunications, navigation, geodesy, traffic control, and safety [134-138]. It is significant that many of these applications require time/frequency techniques, yielding an ancillary capability for TFD. Satellites are more advantageous than many conventional TFD techniques in terms of global coverage, accuracy of time transfer and propagation degradation. This occurs through the unique height position of a satellite relative to earth, allowing satellite visibility to intercontinental areas using line of sight radio frequency propagation. During the past decade many TFD experiments have been made via satellite; the results have been very encouraging. In the future, satellites may broadcast time and frequency signals on an operational basis; such transmissions, however, will no doubt be supplementary in function, as the cost of construction, launch, and maintenance would seem to prohibit a dedicated satellite solely for purposes of TFD. It is beyond the scope of this study to examine in detail the many satellite transfers of time and frequency. In turn we will (1) discuss some basic concepts of satellites as related to TFD, (2) give comparative results of TFD via satellite over the last 10 years, (3) briefly describe several U.S. Navy navigation satellite systems useful for TFD, (4) show the NBS approach to distributing time and frequency signals via satellite, and (5) outline both advantages and limitations of satellite systems for TFD.

(1) *Some Basic Satellite Concepts.* The major problem confronting the user of TFD techniques by earth-bound radio signals is the difficulty of predicting the radio delay path which results from the complexities and reflections in the ionospheric-atmospheric propagation. Artificial satellites, however, are used both as relays and signal sources with onboard clocks and, in combination with

VHF (and higher) radio signals, can overcome the radio delay uncertainty problem to a large extent [139]. Propagation delays of satellite signals can be calculated to high accuracy ( $\leq 10 \mu\text{s}$ ); the refractive index for most satellite-to-earth radio paths is near the free space value since the ionosphere and troposphere constitute a small fraction of the total path; and multipath effects are negligible for all but the highest accuracy users who might receive the signals at low elevation angles. On the other hand, satellite systems are expensive, launched for primary missions other than TFD, and the satellite is never exactly fixed in position relative to a user antenna. Consequently, there is a multiplicity of choices and tradeoffs to be made in designing a satellite system for a given situation.

TABLE 10.8. Classification of satellites by altitude

Altitude Classification	Altitude Range—km (Above earth's surface)	Satellite Period
Low	900- 2,700	~ 100 to 150 min.
Medium	13,000-20,000	7 to 12 h
High (Synchronous)	22,000-48,000	13 to 35 h
	36,000	24 h

Consider the matter of orbit. Should it be circular or elliptical? At what altitude above earth? Easton classifies satellites by altitude as shown in table 10.8 [140]. Very definite characteristics are implicit in these 3 classifications. Figure 10.34 shows one of these; namely, the farther out the satellite is the greater the earth coverage until near maximum coverage is reached at synchronous altitude. On the other hand, the signal strength decreases with altitude increase; also, if the satellite is equipped to maintain a precise orbit and fixed orientation to earth as well as possess the capability of transponding signals, additional integral components are required. Or, look at the factor of earth coverage—one synchronous equatorial satellite is constantly in view (24 h) to about  $\frac{1}{3}$  of the earth's surface (3 satellites could provide near global coverage); a decrease in satellite altitude is characterized by a shortened period with nearly global coverage (in view for short periods of time at one station), and the Doppler effect, sometimes used in navigation, becomes more pronounced. Operation of a satellite with an on-board clock complicates clock maintenance and necessitates periodic adjustments, although no continuous RF transmission is required from the ground. Use of a satellite relay or transponder permits the clock to be maintained on the ground and allows use of a general purpose communication satellite on a time-shared basis. In a one-way satellite system the users receive signals from the satellite in a listen or receive-only mode. A two-way satellite system usually involves bilateral communications between separated reference and receiver

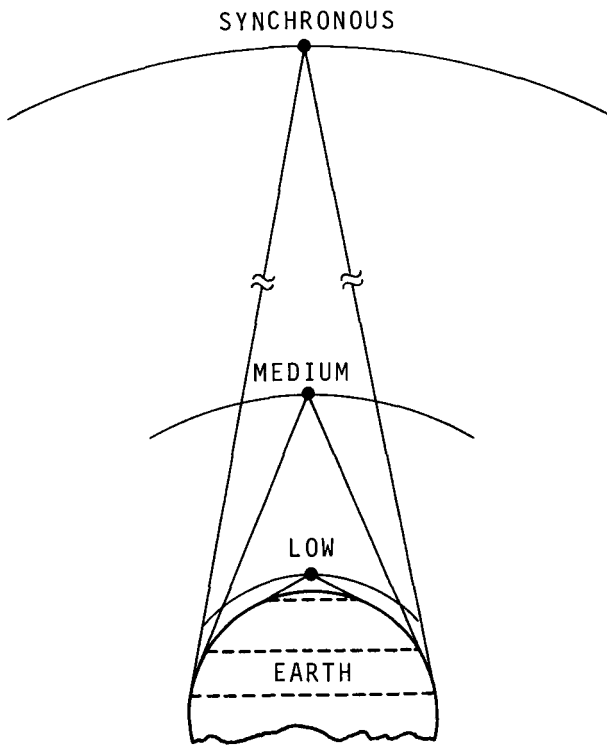

FIGURE 10.34. Relative earth coverage by satellites at various altitudes.

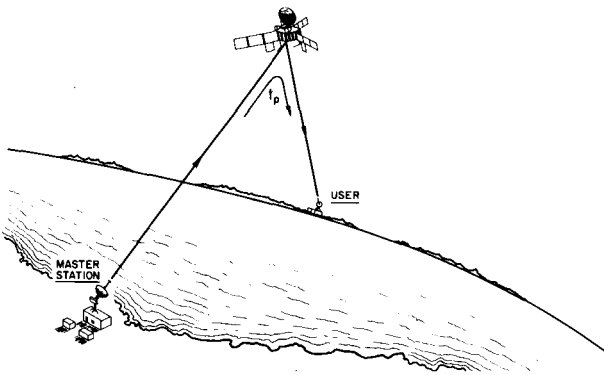

FIGURE 10.35. One-way satellite timing mode.

clocks on the ground through relay via the satellite transponder. In either one or two-way transponder mode the satellite must be visible to both the ground transmitter and all receiving stations at an angle of at least  $5^\circ$  above the horizon of each. An on-board clock mode provides timing information directly from a satellite in a one-way mode. The following discussions describe the 3 major means of satellite TFD:

*One-way mode.* The users operate in a listen or receive-only method. As shown in figure 10.35 the

transmitted terrestrial standard source is relayed by the satellite transponder to the earth receiver. The accuracy of time transfer in this mode is dependent upon the knowledge of the absolute propagation delay between the ground transmitter—satellite transponder— and ground receiver.

With VHF transponders (ATS 1 and 3) the available bandwidth is  $\sim 100$  kHz which limits use of pulses at fast risetime. An alternative means for resolving time differences in the one-way mode employs the so-called side-tone ranging technique. (This technique also can be used in the two-way mode.) There are variations even in this technique; one method uses a 10-kHz tone, phase locked to a time standard with its zero crossing coincident with the clock's 1 pps [141]. Bursts of the 10-kHz tone are transmitted at different repetition rates to resolve ambiguities. The receiving station detects the satellite-transponded signal and decodes with sampling rates equivalent to the transmitted tone-burst rate in terms of the receiver clock. A typical decode by this technique is shown in figure 10.36, where burst repetition rates of 1, 10, 100, and 1000 times per second, as well as the continuous frequency of 10 Hz, were transmitted and received to determine the total relative time difference between two remote clocks. The beginning of each tone burst marks the time delay increment for each different pulse rate except that the continuous 10-Hz signal is read when the tone crosses the zero axis. The lowest tone used reduces the ambiguity of the timing information, while the highest tone provides the limit of resolution. The delay thus determined includes the clock differences, equipment delays, and propagation path delays.

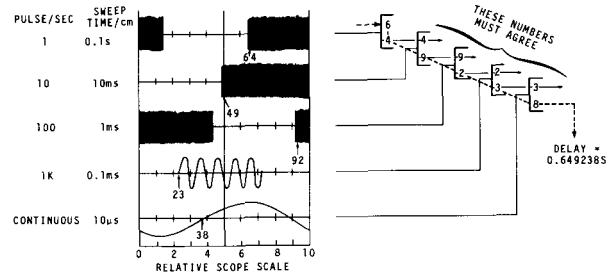

FIGURE 10.36. Example of arrival time via side-tone ranging of satellite signals [150].

If the path delays can be separated out, the other factors are resolvable to high accuracy. Path delays may be determined from orbital elements which sometimes are relayed by satellite. (Orbital elements describe the satellite's orbit and its position in that orbit at a given date; they include six constants of motion which in one form include period, eccentricity and inclination [142].) The orbital elements

are obtained from observations over a period of time and are issued periodically by agencies responsible for operation of a given satellite. A major difficulty in timing via the one-way mode satellite system is the variability in delay caused by the satellite motion. A Root-Sum-Square (RSS) error analysis for the one-way mode is reported as  $0.9 \mu\text{s}$  when factors of equipment and VHF propagation delays, position uncertainties of the satellite and receiving stations, and clock instabilities are taken into account [2]; another analysis, without a clock instability factor, gives an RSS error of  $0.35 \mu\text{s}$  [3].

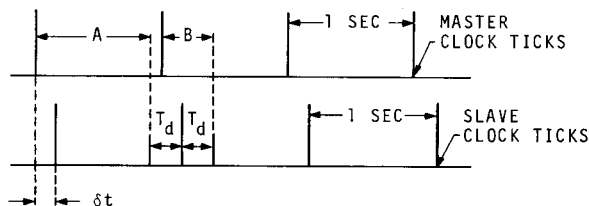

FIGURE 10.37. Typical two-way satellite time diagram.

*Two-way mode.* The users operate in both a listen (passive) and transmit (active) mode, although the satellite still relays the signals as in the one-way case. However, an exchange of information between the two ground sites permits a measure of the path delay, thus obviating the need for knowing the location of either the satellite or earth stations. A simplified timing diagram for a two-way satellite system is shown in figure 10.37. Specific techniques vary but the following is given as an example. Assuming that the master and slave clocks are synchronized to one second, one can adjust the transmitted time signals to arrive “on time” at the slave site via a voice communication link. The total delay in the transmitted time signal is designated  $A$  in figure 10.37.  $A$  is related to the time difference between the master and slave clocks,  $\delta t$ , and the one-way path delay between ground transmitter—satellite—slave ground station,  $T_d$ , as follows (using 1 pulse per second time ticks):

$$A = \delta t + (1 - T_d). \quad (10.4)$$

Following synchronization of the slave clock with the master clock, the slave station transmits uncorrected clock signals directly back to the master station where they arrive via the satellite relay at a time  $B$  later.  $B$  has the following relationship

$$B = \delta t + T_d. \quad (10.5)$$

Since one can measure both  $A$  and  $B$  at the master station, the difference between the two ground clocks,  $\delta t$ , can be determined by combining eqs (10.4) and (10.5) with the propagation delay,  $T_d$ ,

dropping out. Thus,

$$\delta t = (A + B - 1)/2. \quad (10.6)$$

In this case  $0 \leq \delta t \leq T_d$ ; in most cases  $\delta t$  will be less than  $T_d$  which is  $\sim 0.25$  s in the synchronous satellite case. (Different formulas hold for other clock-difference, propagation-delay relationships.)

Jespersen et al., used the above technique with alternate pulse rates of 1 and 100 pps to synchronize widely separated clocks to about  $4 \mu\text{s}$  with a synchronous-satellite transponding VHF signals [143]. Degrading factors such as satellite movement during satellite signal exchange, nonreciprocity of path, carrier frequency dispersion, and variation in equipment delays can adversely affect the accuracy of the two-way mode. If one neglects clock instability, two reported error budgets give RSS values of  $\sim 0.2 \mu\text{s}$  [2] and  $\sim 0.14 \mu\text{s}$  [3], of which equipment delays are principal contributors.

*On-board clock mode.* This satellite technique can employ either a crystal or atomic clock within the satellite which transmits timing information directly to a terrestrial receiver. (It is conceivable that aircraft also could receive such timing information for use in collision avoidance or air traffic control.) The degree of accuracy realized in this timing mode is directly related to the certainty with which the propagation delay between the satellite and ground station is known, as in the one-way mode. This technique offers an excellent means of clock time transfer whereby two stations receive the same satellite transmission and difference their results over a period of time (time transfer technique). Although the position of a clock-carrying satellite in geostationary orbit could be fairly well established, time data from such synchronous satellites would be subject to relativistic gravitational shifts of  $\sim 50 \mu\text{s/day}$  and second order Doppler shifts of about  $4.4 \mu\text{s/day}$  [144]; these constant terms, however, are compensable and should not limit the accuracy.

On the other hand, TFD via low altitude orbiting satellites is complicated by the Doppler effect of the moving transmitter which can cause shifts as large as  $25 \times 10^{-6}$  in the received frequency at a ground station (minimum Doppler shift occurs at closest approach to an earth receiver). Thus, timing resolution requires accurate tracking information. An error budget for the satellite on-board clock has been given as  $0.25 \mu\text{s}$  RSS [3] and  $0.7 \mu\text{s}$  RSS [2]. The variations of these estimates result from differences in the assumptions for carrier-frequency propagation errors and uncertainties in both satellite position and equipment delays.

In summary, the one-way mode can satisfy a multiplicity of users at widely separated points with some sacrifice in accuracy principally because of path delay uncertainties caused by satellite position error. The two-way mode can service only a small



number of users, but, with elimination of the path delay problem and the addition of a communication link, it appears this method could realize submicrosecond capability. On-board clock techniques have similar advantages and limitations of the one-way mode.

(2) *Some results of TF comparisons via satellites.* The first time experiments via artificial satellites were conducted in August 1962, using the communication satellite Telstar [145]. These experiments related time at the USNO in Washington, DC to that at the Royal Greenwich Observatory (RGO) in England to about  $1 \mu\text{s}$  (with about  $\pm 20 \mu\text{s}$  assigned to an LF ground link error). The two-way mode was employed

using  $5\text{-}\mu\text{s}$  pulses at a 10-pps rate and microwave carrier frequencies. Since that time many experiments have been made via the one-way mode and the low orbiting on-board clock technique. Laidet reports a relative accuracy of  $20 \mu\text{s}$  between the TRANSIT satellite on-board clock and Centre National d'Etudes Spatiales (CNES) network clocks [146]. Table 10.9 shows results of various time and frequency experiments via satellites during the past ten years, including applicable satellite characteristics. These results indicate the excellent potential for TFD via satellites between widely separated global points in the microsecond accuracy range.

TABLE 10.9. Selected Time/Frequency Comparisons via Satellites (1962-1973)

Date	Satellite	Orbit	Carrier frequency	Mode of measurement	Purpose of test	Stated accuracy	Reference
August 1962	TELSTAR	Elliptical Apogee ~ 4800 km Perigee ~ 800 km	(SHF) 6.4/4.1 GHz	Two-way relay	Clock comparison—RGO (England) and USNO (Washington, DC) via Andover, ME	$\sim 1 \mu\text{s}$	[145]
February 1965	RELAY II	Elliptical Apogee ~ 4800 km Perigee ~ 1400 km	(SHF) 1.7/4.1 GHz	Two-way relay	Clock comparison—RRL (Japan) and USNO via Mojave, CA	$\sim 0.1 \mu\text{s}$	[147, 148]
June-July 1967	ATS-1	Equatorial near synchronous	(VHF) 149.2/135.6 MHz	Two-way relay	Two-way time sync experiment	$4 \pm 2 \mu\text{s}$	[143]
November-December 1967	ATS-1	Equatorial near synchronous	(VHF) 149.2/135.6 MHz	One-way relay	Worldwide time sync experiment	10 to $60 \mu\text{s}$ *	[149]
January 1968-April 1972	GEOS-II	Elliptical near polar Apogee 1480 km Perigee 1110 km	(VHF) 136.3 MHz	One-way from on-board clock	Time sync of some 8 worldwide tracking stations	$25 \mu\text{s}$	[150, 151]
March-October 1969	TRANSIT	Low altitude (~ 1100 km) circular/polar	(UHF/VHF) 400.0/150.0 MHz	One-way from on-board clock	Synchronization of 6 French satellite control networks	$20 \mu\text{s}$	[146]
February 1970	DSCS	Near synchronous drifting ~ 25%/day	(SHF)	Two-way relay	Experimental program to determine feasibility of replacing military portable clock trips	$0.1 \mu\text{s}$ ( $\sigma \sim 0.2 \mu\text{s}$ )	[152]
June-July 1970	ATS-3	Equatorial near synchronous	(SHF)(C-Band) 6.2; 6.3/4.1 GHz	Two-way relay	Time sync experiments at C-band carrier frequencies	$0.05 \mu\text{s}$	[153]
February-August 1971	TACSAT	Equatorial near synchronous	(UHF/VHF) 303.4/249.6 MHz	One-way relay	Evaluation of one-way mode for clock sync at stations in North and South America	$150 \mu\text{s}$ †	[154, 155]
	LES-6	Equatorial near synchronous	(UHF/VHF) 302.7/249.1 MHz	One-way relay		$25 \mu\text{s}$ ‡	
Late 1971	TIMATION II	Low altitude (~ 925 km) circular 70° inclination	(UHF) 400 MHz	One-way from on-board clock	Satellite time sync experiment	$\sim 1 \mu\text{s}$ ■ $\sim 4 \mu\text{s}$ ■■	[156]
August 1971-1973	ATS-3	Equatorial near synchronous	(VHF) 149.2/135.6 MHz	One-way relay-wide area broadcast	Experimental Time/Frequency Dissemination	$\sim 50 \mu\text{s}$	[157]

\* Dependent upon age of orbital elements.

† Within 2 weeks of orbital element date.

‡ Within 12 h of orbital element date.

■ 4-day old orbital data.

■■ 6-day old orbital data.

TABLE 10.10. Characteristics of the Operational TRANSIT Satellites

Scientific Name	Designation	Launch Date	Period (min)	Perigee (km)	Apogee (km)	Inclination (deg)	Eccentricity	Right Ascension of Ascending Mode (deg)
1970 67A	30190	27 Aug 1970	106.98	949.7	1218.2	90.04	0.018	238.2
1968 12A	30180	2 Mar 1968	106.93	1024.7	1138.4	89.99	0.0076	279.0
1967 92A	30140	25 Sept 1967	106.75	1036.0	1110.6	89.23	0.0050	88.1
1967 48A	30130	18 May 1967	106.96	1066.8	1099.0	89.63	0.0022	12.4
1967 34A	30120	14 Apr 1967	106.48	1046.9	1074.3	90.20	0.0018	348.8

(3) *Timing via U.S. Navy navigation satellites.*  
 (a) *Navy Navigation Satellite System (NNSS)—TRANSIT.* The NNSS is primarily a means for determining accurate navigation fixes through Doppler measurements of accurate radio signals transmitted from low-altitude moving satellites (velocity  $\approx 7$  m/ms) [142, 158, 159]. A secondary function, of interest to TFD, is the continuous transmission of timing marks at 2-minute intervals. These marks are referenced to the UTC time scale and are periodically updated through a ground support network. The TRANSIT system became operational in 1964; it presently consists of 5 satellites with on-board clocks and in nearly-circular polar orbit as shown in figure 10.38. The satellites were spaced initially so that their planes of orbit would be  $\sim 45^\circ$  apart at the equator. Each are visible from all points on earth several times a day due to their orbital motion around the rotating earth. Characteristics of the 5 orbiting satellites are given in table 10.10.

A fairly elaborate correction network exists for the TRANSIT system. It consists of 4 tracking stations in Hawaii, California, Minnesota, and Maine,

a computing center, a time reference link to the USNO, and two ground to satellite communication sites or injection stations [160]. A pictorial diagram of the TRANSIT system is given in figure 10.39. The satellites are monitored continuously with information flow to the computing center; orbit predictions for the 16-hr intervals are determined and transmitted to the TRANSIT satellites, together with timing resets, from the injection stations. This information is rebroadcast from the satellites as explained below.

The heart of the on-board clocks consists of high quality 5-MHz crystal oscillators, requiring a frequency stability of at least a part in  $10^9$  for an observation period of  $\sim 15$  minutes. An example of the TRANSIT crystal oscillator stability is shown in figure 10.40 where the effects of launch are shown as well as the stability recovery 12 to 16 hours after launch. About 2 weeks later the stability per day is better than a part in  $10^{10}$ . Current in-orbit oscillators exhibit stabilities of several parts in  $10^{11}$  per day over intervals of 100 days [160].

The TRANSIT satellite continuously transmits crystal stabilized signals at two phase modulated (PM) frequencies— $\sim 150$  and  $\sim 400$  MHz. (Two frequencies are used to minimize the refraction error which is inversely proportional to the square of the carrier frequency.) The radiated power is  $\sim 0.1$  watt, providing useful signals up to distances of about 3500 km [160]. Navigation information is given in 2-min segments which begin and end at the instant of each even minute. A digital encoded time marker is broadcast with time uniquely marked at the instant of the even minute by the appearance of a 400-Hz switching tone. A typical TRANSIT timing signal is shown in figure 10.41. Laidet used such TRANSIT signals in synchronizing worldwide French tracking stations to  $20 \mu\text{s}$  [146].

In the timing application of TRANSIT signals one must know the orbit of the satellite and the location of receiving site. For a stationary receiving position one can fix the satellite's position from the transmitted orbital parameters, calculate the range and thus determine the signal propagation delay. Presently, the satellite time is set to UTC in  $10\text{-}\mu\text{s}$  steps; thus,  $10 \mu\text{s}$  is the upper bound of clock setting accuracy although averaging can reduce these time step effects [146]. The equipment for the complete navigation capability for NNSS, including

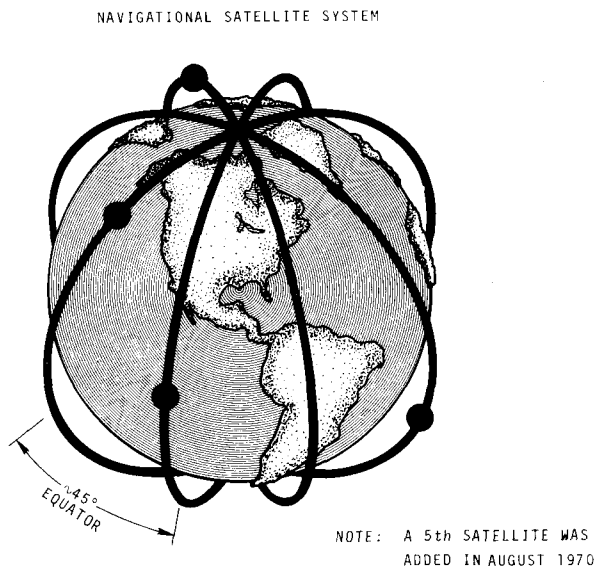

FIGURE 10.38. TRANSIT satellites showing 4 polar orbits. (Consecutive orbits do not repeat around rotating earth.)

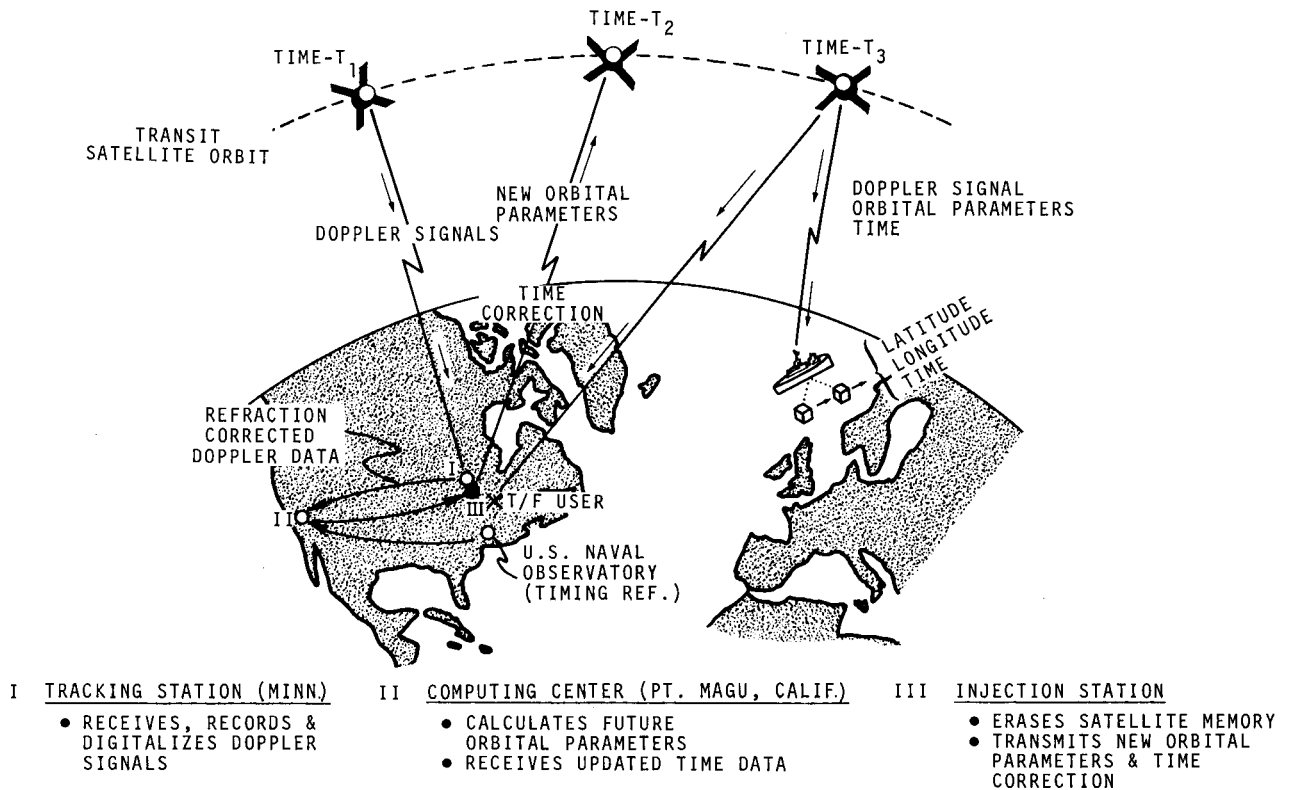

FIGURE 10.39. TRANSIT satellite system operation.

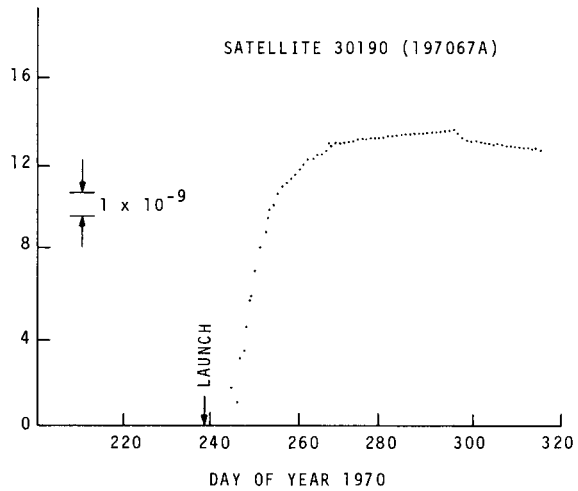

FIGURE 10.40. Typical TRANSIT on-board oscillator stability curve.

digital computer and data processor is quite expensive, however, a simple non-directional whip antenna can be used at a ground station with a commercially available "satellite time recovery receiver,"

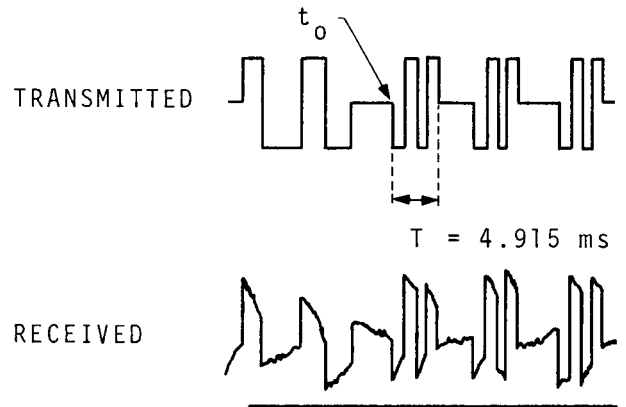

FIGURE 10.41. TRANSIT timing signal (transmitted every 2 min. [146]).

costing about \$2500 [160]. Future plans for TRANSIT type satellites include crystal oscillator drift correction, coarse time resolution to 200 ns, date adjustment precision  $\sim 1 \text{ ns}$ , and pseudo random noise (PRN) time-code modulation [160, 161].

TABLE 10.11. Characteristics of TIMATION Satellites

Name	Launch Date	Period (min)	Orbit	Altitude (km)	Carrier Frequency	Oscillator Stability	Status
TIMATION I	31 May 1967	~ 103	Circular 70° inclination	925	400 MHz	$3 \times 10^{-11}$	Inactive
TIMATION II	30 Sept 1969	103.4	Circular 70° inclination	925	{ 150 MHz 400 MHz	$1 \times 10^{-11}$	Active
TIMATION III	FY 1974	~ 480	Circular 125° inclination	13,875	{ 335 MHz 1580 MHz	$\sim 2 \times 10^{-12}$	Scheduled Launch

(b) Navy TIMATION satellites for TFD. TIMATION is a proposed navigation system using a multiplicity of medium-altitude, circular-orbiting satellites with on-board clocks. Two experimental satellites have been launched to date in a low-altitude orbit; a third launch to medium altitude is planned for the near future [140, 163]. Characteristics of TIMATION satellites are given in table 10.11.

Easton has described a TIMATION timing technique for determining the travel times between a moving satellite and a receiving station through phase comparisons of a received radio signal [140]. His technique includes (1) transformation of the satellite position to that of a celestial navigation concept; (2) use of a Marcq St.-Hilaire type of precomputed intercept chart for plotting arrival times and determining a fix; (3) transmissions of low frequency modulations on a UHF carrier, sequenced in order similar to side-tone ranging; (4) comparison of the received signals at a remote site where a duplicate sequence of time-ordered frequencies is generated, thereby determining an arrival time measurement consisting of both propagation delay and satellite-receiver clock differences, and (5) plotting the arrival times on the Marcq St.-Hilaire intercept chart to determine the clock differences as well as the range and/or path delay to the satellite. TIMATION satellite positions, both prediction and post-diction, were obtained from Doppler measurements by the TRANET tracking network and processed to give a computed time delay between the satellite and selected receiving stations.

In 1968, TIMATION satellites were used in an experiment to compare widely separated clocks in Alaska; Colorado; Washington, DC; and Florida. The results of these time-transfer measurements are given in figure 10.42; the overall RMS error shown over a period of 10 to 15 days is stated to be  $0.55 \mu\text{s}$  [140]. Experiments in late 1971, using TIMATION II passes in a southeasterly direction over the central USA and the Atlantic Ocean, gave differences between computed and measured delays of  $\sim 1 \mu\text{s}$  for 4-day old orbit ephemeris data; 6-day old data gave results 3 to  $4 \mu\text{s}$  in error [156]. In 1972 time transfer measurements between clocks at the Royal Greenwich Observatory (RGO) and the USNO were made via TIMATION II at nearly concurrent times.

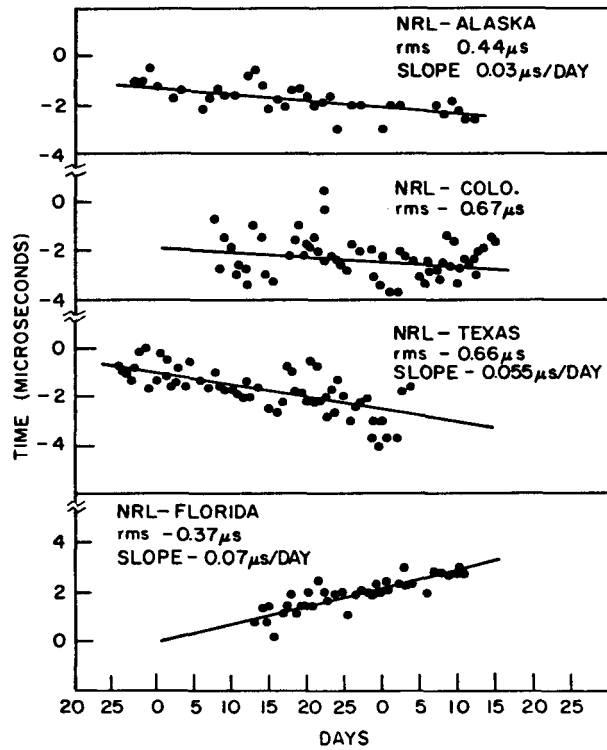

FIGURE 10.42. Time transfer results via Timation II satellite [140].

The results were comparable to Loran-C and portable clock measurements within  $1.5 \mu\text{s}$  and indicated a time-transfer capability of  $0.5 \mu\text{s}$  accuracy [162].

TIMATION III, scheduled for launch in Fiscal 1974, is a considerably improved version of TIMATION II [163]. It will be visible over intercontinental ranges for observation periods of  $\sim 2$  hr; provide limited use of pseudo-noise modulation signals at 1.580 GHz, and possess a memory which can store orbital information. Considerable attention is given

the TIMATION crystal oscillators to compensate for temperature changes and radiation effects as well as lower the crystal aging rate. A TIMATION satellite receiver has been developed and built; its cost estimate is \$20,000, although quantity demand should reduce this considerably.

(c) *Defense Satellite Communication System (DSCS) for TFD.* The DSCS uses some 21 equatorial drifting satellites (Phase-1 type drifting  $\sim 25^\circ/\text{day}$  at  $> 32,000\text{-km}$  altitude [135, 152, 164]) for communication, and the system provides a precise time mechanism for comparison of clocks at inter-continental military installations. The DSCS method is being used to successfully compare distant clocks to less than  $1 \mu\text{s}$ , replacing many expensive portable clock trips.

With certain communications equipment the time transfer requires no signal insertion or disturbance of normal operation; the regular pseudo-random code stream is transmitted, received, and matched to give a measure of clock difference if the propagation delay is accounted for. Both two-way and one-way modes have been used to determine clock differences in the *time transfer method* (subtraction of clock data). DSCS timing tests between Brandywine, MD and the SATCOM facility at Heleman, HI gave about  $0.1\text{-}\mu\text{s}$  clock difference and a standard deviation of  $0.16\text{-}\mu\text{s}$  for a series of 34 clock measurements in 1970 [152]. DSCS time transfer systems have been developed for terminals not equipped with regular communication modems (mini-modems) [165]. Clock comparisons have been made between short earth distances to about  $0.2 \mu\text{s}$  using the Mini-Modem equipment [152]. The DSCS operationally transfers USNO time, via a microwave link to the Brandywine, Maryland terminal, to points in Europe, USA, and the Pacific area to  $\sim 0.1 \mu\text{s}$  as shown in figure 10.43 [166].

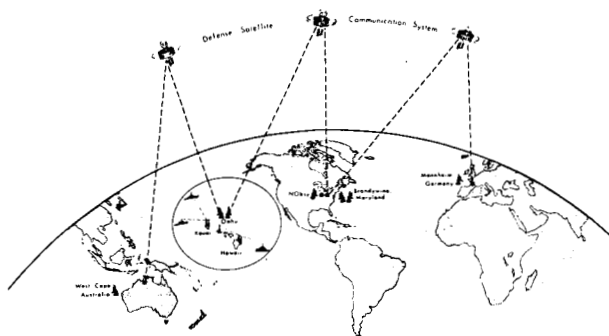

FIGURE 10.43. TFD via Defense Satellite Communication System (DSCS).

(4) *NBS satellite TFD experiments.* The high accuracy and wide bandwidth at microwave carrier frequencies of complex military satellite transmissions is at the expense of costly equipment which is beyond the range of many users. Such high cost

of equipment prompted NBS to take a somewhat different approach to still realize the potential of accurate time and frequency dissemination via artificial earth satellites. An experimental satellite timing program has been in progress at NBS since mid 1967 and is part of a continuing research effort to develop systems beneficial to a large number of users. NBS has worked only with geostationary satellites, and initially conducted two-way experiments using the NASA-Application Technology Satellites (ATS) containing VHF transponders at about 150 MHz. With inexpensive receivers and transmitters, accuracies of about  $4 \mu\text{s}$  were reported for these studies [143]. Basic ionospheric effects did not appear to limit the results. One-way satellite experiments, using the ATS transponder at VHF, gave clock comparison accuracies of 10 and  $60 \mu\text{s}$  for respective orbit positions a) at the time of measurement, and b) for a one week advanced prediction [149].

Recently, NBS has performed additional one-way transmission tests with communications satellites such as LES-6 (Lincoln Experimental Satellite) and TACSAT (Tactical Communications Satellite) [154, 155] as well as the Application Satellite ATS-3 [157]. These satellites operated in the VHF and UHF bands in the frequency range of 150 to 304 MHz. At these frequencies and with the power of transmission involved, one is able to use small, inexpensive antennas with a SNR more than adequate for the measurements. A pictorial view of the master station and five receiving stations used in typical one-way clock synchronizations is shown in figure 10.44. The results of such measurements have been given in table 10.9.

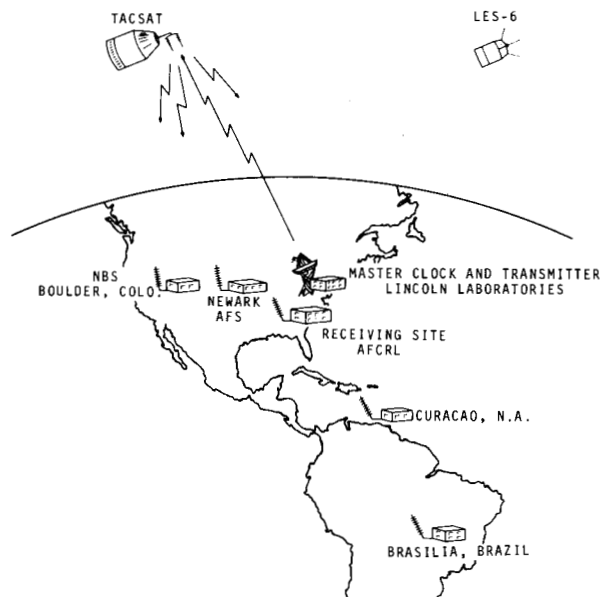

FIGURE 10.44. Experimental TACSAT and LES-6 satellite network

As noted earlier, the satellite positions used in the NBS experiments have been based on orbital information supplied by the agencies controlling the satellites. NBS investigated an alternative approach which could prove adequate for many users. Trilateration techniques were used to locate a satellite through relay range measurements by three widely separated stations during simultaneous transmission of timing signals. Concurrent with the trilateration measurements was the synchronization of clocks at other remote sites; the same timing signal was used for simultaneous ranging and clock synchronization. The accuracy of the range determination depends upon the accuracy of the clock synchronization at the remote sites as well as the range measurement resolution. (A rather low range resolution of 3000 meters was obtained for these experiments.) From the determined satellite position, propagation delays to earth points can be computed; using this approach, it was possible to synchronize clocks other than tracking site clocks to about  $40\mu\text{s}$  over intercontinental distances using TACTAC and LES-6 at two different times [155]. It is estimated that the technique could provide accuracies near 1 to  $10\mu\text{s}$  if one used precisely synchronized clocks and improved the range resolution; i.e., less uncertainty in the equipment delays.

A similar technique has been reported by Russian scientists; they used an ISZ type MOLNIYA-1 satellite (in an inclined elliptic orbit at low to high altitude [136, 167]) together with the "orbit" television system to synchronize remotely-located time scales [115]. The satellite coordinates were determined at the moment of time synchronization from three widely separated points; i.e., Moscow and Vladivostok in Russia and a reception point of the "orbit" television signals in France. The experimental results, after establishing earth coordinates and measuring delays, showed synchronization of time scales to about  $10\mu\text{s}$  over earth distances of 8000 km. The technique is of value for synchronizing remote sites which are inaccessible to direct TV reception [115].

At this point we will describe some concepts and techniques which have evolved from recent experimental work at NBS with the ATS-3 satellite. A promising experiment, ending in late 1973, consisted of two 15-min broadcasts (5 days a week) with a WWV/WWVH type format from ATS-3 [157]. The broadcasts were "on time" with reference to UTC and originated at the NBS Laboratories at Boulder, CO. The signals were transmitted (uplink) to the ATS-3 satellite via a 149.245 MHz carrier; they were transponded (downlink) at a carrier frequency of 135.624 MHz to a wide earth coverage area including North and South America, large parts of the Atlantic and Pacific Ocean and parts of Western Europe and Africa.

The 1971-73 experiments show a potential for various accuracy levels of service; three have been demonstrated and will be described briefly. First,

a coarse time check is possible through simply listening to the time ticks or voice announcements broadcast from the satellite. These signals are accurate to about 0.25 second—the signals left Boulder on time but were delayed in traveling to the satellite at  $\sim 36,000$  km altitude and back to earth. (The transponder delay is insignificant at this level.)

The second level of accuracy is attained by measuring the difference between the arrival time of the received "ticks" and those generated by a local clock. From oscilloscope measurements one can achieve 10-ms resolution between the received signal and his clock by visually averaging the position of a positive-going zero crossing of the first cycle of the tick. However, as in all one-way satellite measurements, allowance must be made for propagation delay. To overcome this problem NBS prepared path delay contours on ATS-3 coverage maps, based on orbital elements issued by NASA, as shown in figure 10.45. From such contours one can read the propagation delay from the Boulder transmitter to the satellite and from the satellite to an earth receiving point. Satellite movement obsoletes these contours; updated contours were published monthly, together with receiving antenna pointing charts which gave elevation and azimuth angles to the satellite anywhere within the coverage area [42]. Application of such chart corrections to the oscilloscope readings provides timing to a few milliseconds.

The third level of service provides timing to better than  $50\mu\text{s}$ . This technique is predicated upon the accuracy of NASA's orbital elements which permit predicted propagation delays from Boulder to any point in the satellite's view to within 10 to  $20\mu\text{s}$ . Voice broadcast gave the satellite's longitude, latitude and a radius correction. To take advantage of this capability for the benefit of the user, NBS designed a special purpose delay computer in the form of a circular slide rule [168]. Figure 10.46 shows a picture of the prototype delay computer. To use this computer one enters the satellite position information together with the latitude/longitude coordinates of the receiving point and determines the propagation delay to within 10 to  $20\mu\text{s}$ .

The differences between theoretical delay measurements and slide rule calculations at NBS Boulder from the transmitter—satellite—receiver are shown in figure 10.47. The slide rule calculated delays agree with the theoretical computer delays to several microseconds over a relatively large range of latitude and longitude. The results of these ATS-3 experiments are reported in detail by Hanson and Hamilton [157]. Figure 10.48 gives both a block diagram and photo of the receiving equipment that could be used in the ATS-3 timing experiments. The receiving equipment can be simple and inexpensive; for optimum results it included a 10-dB gain Yagi antenna, low-noise transistorized preamplifier and a modified FM receiver which costs  $\sim \$150$ .

The experimental ATS-3 satellite broadcasts have proven that concepts of simplicity, various

SAMPLE CALCULATION OF PROPAGATION DELAY FOR A RECEIVER IN WASHINGTON, D.C.	}	DELAY FROM BOULDER, CO. TO SATELLITE	128.9ms	
		DELAY FROM SATELLITE TO WASH. D.C.	126.1ms	
			TOTAL DELAY	255.0ms

(BOULDER, CO. COORDINATES 105°W 40°N WASH. D.C. COORDINATES 77°W 39°N)

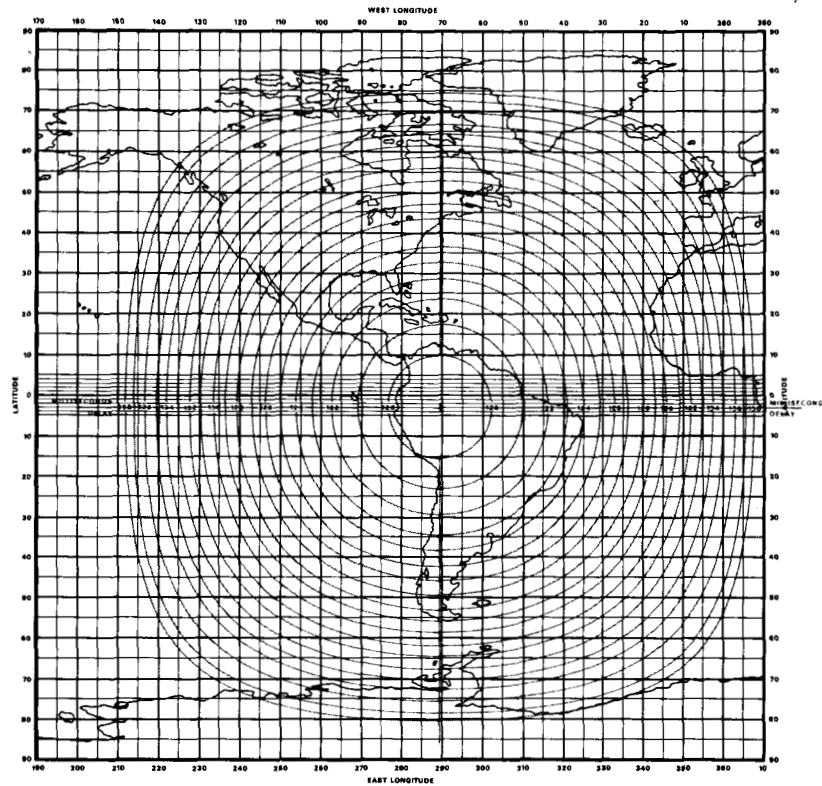

FIGURE 10.45. ATS-3 satellite coverage map with propagation delay contours (1700-1715 GMT, March 1973).

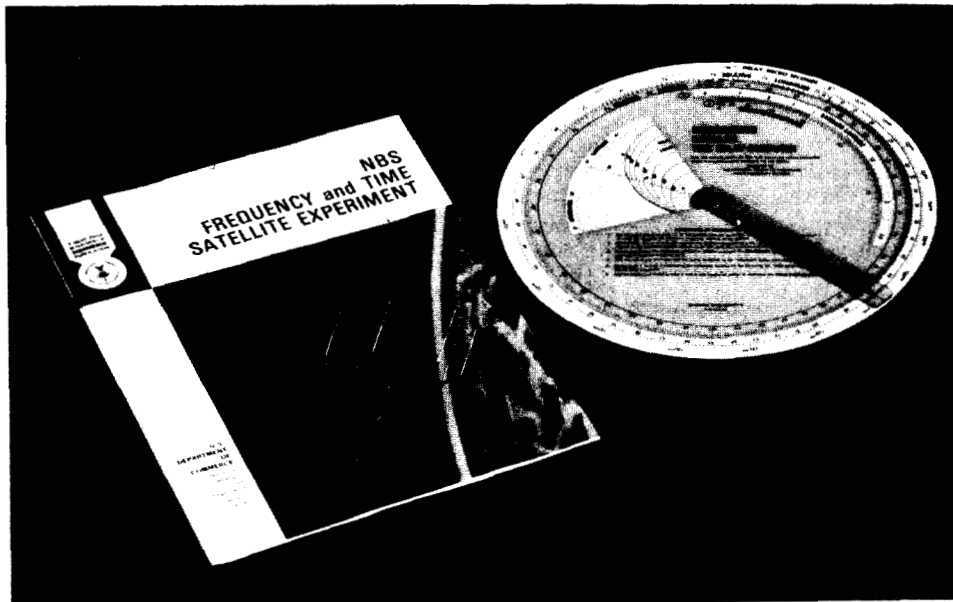

FIGURE 10.46. Slide rule calculator for determining ATS-3 satellite arrival times.

SUB SATELLITE POINT  
 (SSP) = 0.518°N, 68.601°W

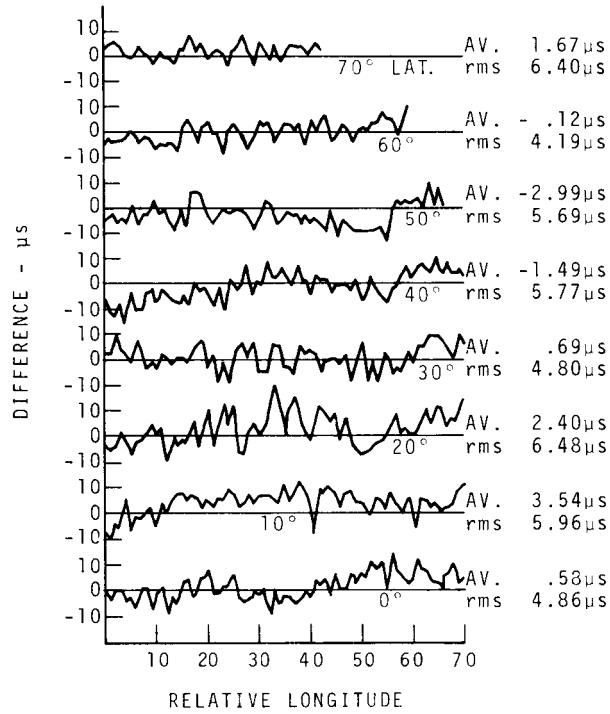

FIGURE 10.47. Theoretical propagation delay minus slide-rule calculated delay (systematic errors removed).

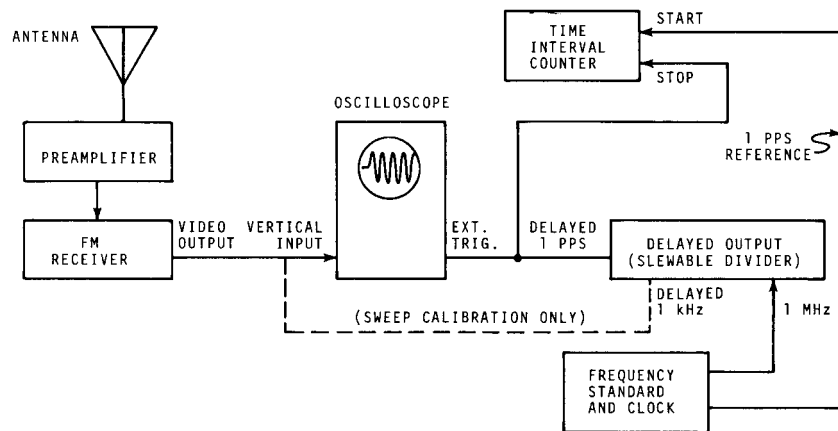

FIGURE 10.48. Block diagram and photo of equipment for ATS-3 satellite experiments.



levels of accuracy, and reliability are achievable with low-cost receiving equipment and are commensurate with the degree of the measurement complexity. NBS may provide 24-h experimental timing at some future time through a Department of Commerce satellite. Many of the concepts and techniques developed in these experimental programs would be applicable to an eventual TFD service via satellite.

(5) *Advantages and limitations of satellites for TFD.* The advantages and limitations are given in

table 10.12 for the two categories of the low-altitude orbiting clock and the synchronous radio-relay. In this evaluation one assumes that these satellites are not launched or justified solely for TFD. (Synchronous satellites with on-board clocks have been proposed but are not considered in this evaluation.) The net conclusion is that satellites offer an excellent potential of meeting the timing needs of many classes of users at various accuracy levels.

TABLE 10.12. *Advantages and Limitations of Satellites for TFD*

Satellite Type	Advantages	Limitations
Low-altitude orbiting satellite with on-board clock.	<ol style="list-style-type: none"> <li>1. Worldwide (periodic) coverage is possible even with one satellite (polar orbit).</li> <li>2. Timing synchronization is available to an unlimited number of passive users within sight of the satellite at any one time.</li> <li>3. Users do not require transmitters as in a two-way mode.</li> <li>4. Short line-of-sight range between the satellite and the user gives a favorable SNR at high elevation angles.</li> <li>5. Clock differences can be determined between receiving stations in a short time period with auxiliary communication.</li> <li>6. This technique is capable of synchronizing world wide clocks to one primary time standard.</li> </ol>	<ol style="list-style-type: none"> <li>1. The satellite dynamic motion causes variation in the signal propagation delay and requires correction for Doppler effects. Compensation for propagation delay is a major factor for use of these satellites in TFD; knowledge of orbit position is essential.</li> <li>2. The availability of timing signals is limited to ~ 10 to 15 min per pass several times a day.</li> <li>3. Accurate time comparison requires continual accounting for equipment delays.</li> <li>4. The on-board clock has limited life and cannot be repaired or modified.</li> <li>5. Clocks in orbit require monitoring and periodic adjustment.</li> <li>6. Operational military systems require expensive and complex receiving components which are impractical for many users.</li> <li>7. Satellite power can fail and/or the satellites can be destroyed.</li> <li>8. The system requires many satellites for redundant and frequent passes.</li> </ol>
Radio-relay type satellites in synchronous orbit.	<ol style="list-style-type: none"> <li>1. There is <i>continuous</i> availability of timing signals to a large area of the earth (~ 1/3 of the globe).</li> <li>2. Two-way modes using simultaneous radio transmissions over reciprocal paths need no correction for propagation delays.</li> <li>3. The system offers an attractive means for re-broadcast of standard frequency radio signals to simultaneous receivers at high accuracy and low cost, using VHF-UHF transponders.</li> <li>4. The master clock is accessible at a ground station and can be continuously referenced to UTC(NBS).</li> <li>5. Wide band microwave transponders are available which permit fast rise pulses and clock synchronization at a receiver to less than 1 <math>\mu</math>s. This is at the expense of costly equipment, however.</li> <li>6. The ionosphere-atmosphere portion of the radio path is small in relation to the total path and causes minor degradation in the line-of-sight VHF and higher frequencies.</li> <li>7. System can replace expensive portable clock trips.</li> </ol>	<ol style="list-style-type: none"> <li>1. Near world-wide coverage requires at least three equatorial synchronous satellites.</li> <li>2. Even synchronous satellites show some movement, and accurate orbital elements are required at the time of measurement for microsecond time synchronization.</li> <li>3. The much longer radio path than that of the low-altitude satellites requires higher transmission power and/or the use of high gain directional antennas.</li> <li>4. Synchronous satellites can be moved, thus changing the earth coverage area, or they may be destroyed.</li> <li>5. Synchronous satellites are considerably more expensive to launch than low-altitude satellites.</li> <li>6. Accurate time comparison requires knowledge of equipment delays.</li> </ol>

### h. Microwave Time and Frequency Transfer (SHF)

The usefulness of this band for TFD has been demonstrated by the TD-2 microwave system in the USA and various systems abroad in long distance routing of television signals; such techniques were discussed earlier in Section 10.3.2.f. Two specific examples of microwave TFD are now described.

Phillips et al., have demonstrated that time and frequency can be transferred two-way at a frequency of  $\sim 7$  GHz between the Naval Research Laboratory (NRL) and the USNO (line-of-sight path of 11.75 km in the Washington, DC area) [169]. In the NRL/USNO microwave experiment, NRL transmitted a 1-MHz signal, derived from a hydrogen maser, to the USNO as shown in figure 10.49. This signal was compared to the USNO master clock; also, the USNO transmitted time and frequency information simultaneously to NRL by the algebraic addition of a 1-MHz signal and 1-pulse per second, both in terms of the USNO master clock. Such a technique enables continuous comparison of both phase (frequency) and date (time) at NRL. Phase resolution was found to be better than 10 ns and date transfer  $\leq 0.1 \mu\text{s}$ . A second microwave link between the USNO and the Waldorf Satellite Research Communication Station (path length of 32.2 km) also provided phase resolution to better than 10 ns. Such a link to nearby Brandywine, MD will be used in connection with the DSCS network for disseminating T/F information to continental terminals [170] (see sec. 10.3.2.g).

The NRL/USNO link has been operating for more than 3 years and shows no diurnal dependence with little effect from seasonal or temperature changes. Wet snow accumulating on the antenna did adversely affect the results. The effects of high-density air traffic crossing the transmission path at a local airport were minimal and of small consequence. The propagation delay is determined by a portable atomic clock. The carrier frequency stability was not critical, and the narrow beam width minimized multipath error. The first information received was by direct path so that the pulse leading edge was used for timing when multipath reflection occurred.

The Jet Propulsion Laboratory (JPL) is also pursuing microwave TFD to link 3 remotely located precision timing systems to a master timing source over distances up to  $\sim 16$  km at the Goldstone Deep Space Communications Complex (GDSC) [171]. They transmit a 1-pps of  $50 \mu\text{s}$  duration at baseband frequencies generally above 2.5 MHz. The rise time of the return pulses is  $\sim 0.4 \mu\text{s}$  between 10 and 90 percent of the initial slope as compared to half that time for the input pulse. Over a period of time some microwave system drift was noted, up to  $\pm 200$  ns. These changes were cyclic and believed to be related to weather anomalies such as relative humidity, temperature changes, and dust storms. In a typical 10-day period the total cyclic excursion did not exceed  $\sim \pm 20$  ns. This microwave system presently links two stations in the Goldstone complex to a relative synchronization accuracy of better than  $1 \mu\text{s}$ .

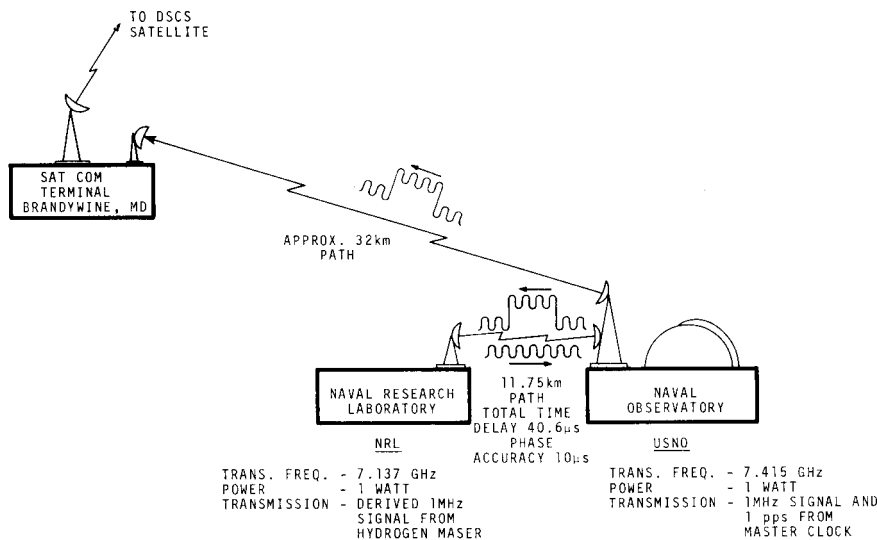

FIGURE 10.49. NRL/USNO microwave links.

### *Advantages of Microwave TFD*

- The system provides extremely accurate transfer of frequency and time information, i.e., phase resolution to  $\sim 10$  ns and time to  $0.1 \mu\text{s}$ .
- System is reliable generally showing small effects from diurnal changes, propagation anomalies, weather, or temperature.
- Once established, the measurement system is simple and straight-forward.
- Simultaneous time and frequency measurements are possible between remote sites of limited range ( $\sim 40$  km) with good reliability.
- System requires very low power of radiation ( $\sim 1$  watt).
- Multipath causes small interference and carrier frequency stability is not critical (precise modulation).

### *Limitations of Microwave Time and Frequency Transfer*

- Initial cost of microwave equipment is high.
- The system is limited to line-of-sight distances of maximum range  $\sim 40$  km.
- Accumulation of snow or ice on the dish antennas can seriously affect the microwave transmission.
- Only a very limited number of users can be served with a microwave T&F system because of geometric limitations of the transmission beams.

#### **i. Commercial Radio TFD Techniques**

The idea of providing standard frequency signals from commercial radio broadcasts is not new, having been employed in the United States in the middle 1920's [172]. In 1927 there were 13 so-called standard frequency stations broadcasting in the range of 17 to 1000 kHz and referenced to standards at the National Bureau of Standards at Washington, DC. The number of stations was limited to those which could be received regularly and reliably at NBS; the results of these measurements were published monthly. Additional "constant frequency stations" were designated when broadcast frequencies were maintained close to licensed values. Of course the accuracies of these signals were many orders of magnitude less than now obtainable; they do, nevertheless, foreshow a potential means of standard frequency dissemination possible today.

About 36 years ago a commercial station in Nashville, TN stabilized their broadcast carrier at 650 kHz to an accuracy of  $\sim 1$  part in  $10^6$ . They used a multiple temperature-controlled oscillator which was periodically checked with WWV at Beltsville, MD [173]. Within the last several years a CCIR

member encouraged this clear channel station to improve the precision control of their broadcasts. They have demonstrated that, today, a commercial broadcast station can transmit precise time and frequency information traceable to NBS and at relatively low cost [174]. The carrier frequency is phase locked to the WWVB received signals at 60 kHz through division, multiplication, and long-term integration, and the resultant frequency stability is  $\leq 1 \times 10^{-9}$ . In addition, a 1-kHz time pulse signal of 400 ms duration is broadcast every 15 minutes. This time is referenced to WWV, with allowance made for propagation delay, and is considered accurate within the range of 1 to 10 ms [175]. A low-cost receiver frequency-marker-generator (\$100) has been designed and built; this unit will receive the 650-kHz signal, to which a 10-MHz crystal oscillator is locked, and produce marker pulses from 10 MHz down to audio frequencies. Initial tests have shown satisfactory results from Nashville to both Evansville, IN ( $\sim 225$  km) and to Boston, MA ( $\sim 1500$  km). Generally, the signal is stable during daytime, but multipath adversely affects it at night. The received accuracy of the broadcast carrier within groundwave distance should be equivalent to that as transmitted in the local Nashville area; received accuracies at skywave distances will be degraded in a similar manner as MF transmissions.

### *Advantages of Commercial Broadcast TFD*

- Simple, cheap and readily available receivers can be used to obtain time and frequency information to relatively high accuracy within ground wave distance of a commercial broadcast station. The commercial station thus serves as a secondary standard which is directly traceable to NBS standards of time and frequency.
- The commercial broadcast station can perform an additional service to the public at small additional cost to itself through NBS low-frequency broadcast reference.
- The service would be of special value to a great number of users who do not require the full accuracy capability of the NBS standard time and frequency broadcasts.
- A network of frequency-stabilized commercial broadcast stations located throughout the larger populated areas of the U.S. could provide secondary time and frequency references to a large percentage of the population.

### *Limitations of TFD via Commercial Broadcast Stations*

- The high accuracy signals generally are limited to ground wave range around the transmitting antenna.
- Special techniques are required for high accuracy comparisons through skywave reception of commercial broadcasts.

#### j. TFD from VHF Signals Reflected from Meteor Trails

Both in the United States and Russia, investigators have reported that meteor burst links will support precise time synchronization and frequency comparisons between remote sites via reflection of VHF signals [176–178]. Sporadic meteors, entering the upper atmosphere about 120 to 80 km above the earth's surface, evaporate and form a thin ionized trail, ~ 15 to 50 km long with a typical lifetime of fractions of a second (100% > 150 ms and 2% ≈ 1.5 s [179]); durations up to a minute, however, have been observed [180]. Meteor scatter forward reflection provides optimum support at the lower portions of the VHF band and the maximum great circle range, limited by the earth's curvature, is ~ 2100 km. Sporadic bursts occur randomly with some 40 to 150 usable meteor trails available per hour. Latorre indicates the minimum time between bursts as one second with only about 5 percent of the intervals between bursts exceeding 100 s [179]. The number of bursts predominate in July with a minimum in February. There are orientation restrictions in transmission and reception of the VHF signals, and directional antennas generally are used. Reflections are specular (angle of incidence equals the angle of reflection at the grazing point of the meteor trail), and the time and frequency measurements depend upon mutual reciprocity of the reflected VHF signals. Sanders et al., report an equivalent rate in change of the propagation path delay as  $0.137 \mu\text{s/s}$  for operation at 46.55 MHz [177]. Such a change, even for a 1 ms time interval between alternate reflections from a common meteor trail, represents ~ 0.1 ns and would be insignificant in precise timing.

Most of the time synchronization studies via Meteor Burst in the U.S. were made between Seattle, WA and Bozeman, MT during the 1960's [176, 177, 181]. The great circle path distance was 880 km and a 46.55-MHz carrier frequency was used at a peak power of ~ 1 kW. In one mode of operation both stations transmitted 50 to 100 pps, derived from local clocks which were coarse synchronized to several ms through WWV broadcasts. At the occurrence of a usable meteor trail, each site simultaneously receives pulses transmitted from the opposite station since they traveled the nearly reciprocal path and experienced the same propagation delay. The time relationship of the received pulses to the local clock pulses provides a measure of the time difference,  $\delta$ , between the clocks at the two remote sites. Consider the simplified timing diagram in figure 10.50. Transmitter No. 1 transmits a square wave pulse with positive-going leading edge at  $t=0$ ; at the time  $t=\delta$ , transmitter 2 also transmits a pulse. While a meteor trail is reflecting, station 1 receives a pulse at time  $T_0 + \delta$  and station 2 at a time  $T_0 - \delta$  as measured at stations 1 and 2 respectively (where  $T_0$  is the propagation delay between a transmitter, meteor and receiver). As different meteors with varying paths are used,  $T_0$  will vary but  $\delta$  will remain essentially unchanged

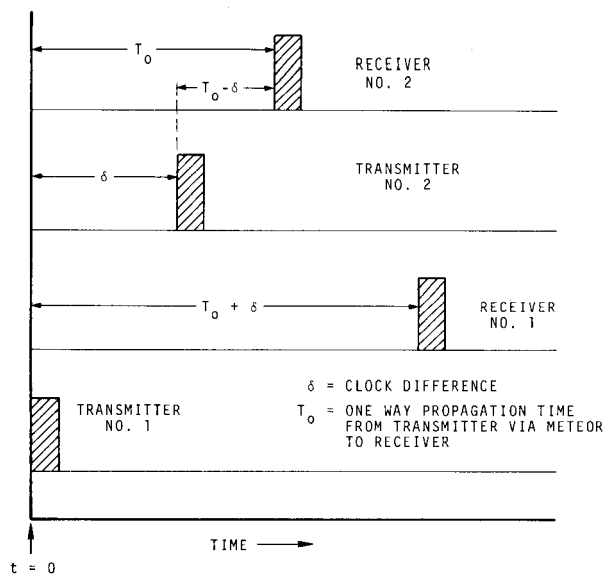

FIGURE 10.50. Simplified meteor-burst timing pulses.

for precise atomic clocks. The difference between the readings at the two stations cancels the propagation delays and yields twice the clock error; the sign of the difference shows the sense of one clock error in terms of the reference clock. A comprehensive analysis must include allowance for transmitter equipment and receiver delays as well as the degree of reciprocity in the propagation delays. It is felt that these delays can be determined ultimately to several hundred nanoseconds [182]; use of identical equipment at each end of the path would minimize the delay determination. The meteor burst method is unique in that the actual propagation delay is measured and can be known.

Different modes of operation have been tried, including both manual and automatic systems. Sanders et al., from timing measurements over a 30-day period, determined the frequency offset  $\delta\nu/\nu_0$  between two remote frequency standards; these data agreed with VLF/LF phase measurements to several parts in  $10^{10}$  [177]. March et al., has shown the inherent phase stability of the meteor-trail, reflected VHF signals and reports that time synchronization via this method has  $\mu\text{s}$  capability [181].

In 1971 it was reported that the Khar'kov State Scientific Research Institute of Metrology (Kh GNIM) compared time scales with the State Standard Scale of the All-Union Scientific Research Institute of Physicotechnical and Radiotechnical Measurements (VNIIFTRI) via meteoric reflection of radio waves [178]. Their method is similar to that previously described except that they employ duplex transmission and retransmission of different pulse trains between two remote sites. This permits an independent readout of the clock difference,  $\delta$ , at each station. The method also minimizes equipment delay errors provided that identical equipment is

used at each station. The system uses a 72.0-MHz carrier frequency with a pulse power of 30 kW and a directional antenna; pulses are of 4  $\mu$ s duration and grouped into code pulses—4 for interrogation and 7 for reception. The marker repetition rate is 10 ms. Measurements were made at 0100 to 0400 (Moscow time) to eliminate interference from AM and FM broadcasting stations, usually off the air at this time. A series of 12 timing measurements for one day over a 4-hour period showed deviations less than 0.8  $\mu$ s and standard deviations of 0.2 to 0.3  $\mu$ s.

*Advantages of VHF Reflection from Meteor Trails for TFD*

- The phase stability of the VHF propagation enables comparison of time scales to high accuracy ( $< 1 \mu$ s) and frequency to parts in  $10^{11}$  at remote sites up to several thousand km apart. This distance probably could be extended through intermediate repeater stations.
- The technique is based on the natural event of meteor bursts and from this standpoint is independent of man-made devices or systems.
- The system would be useful for time and frequency comparisons at remote sites such as the far north and/or inaccessible islands where other techniques are unsuitable or unavailable.
- The technique does not appear to be limited by the propagation, and lack of delay reciprocity seems to be minimal.
- Portable equipment could be used as accurate knowledge of path distance is not required.

*Limitations of the Meteor Burst System for TFD*

- The accuracy of the system is equipment-limited by bandwidth, S/N, and the ability to measure actual component delays.
- The number of potential users is severely restricted because of the directional nature of the propagation.
- The meteor bursts are sporadic, unpredictable as to time of occurrence, and of variable short life. (Some of these limitations can be overcome by statistical techniques and coherent detection.)
- Reception and pulse recognition is hampered by multipath effects, such as Sporadic E, aurora, multiple meteor trails, or changing trail patterns. These effects will vary with such factors as season, time of day, location on the earth, operating frequency, and the orientation of the meteor trail (reflections are specular).
- The meteor burst channel is noncontinuous, and it is indeterminate when time and frequency comparisons can be made.
- Curvature of the earth's surface limits the maximum great circle distance between sites to  $\sim 2100$  km.
- Additive noise can adversely affect the leading edges of the received pulses causing uncertainty in the pulse position measurements.
- The necessary equipment is somewhat complex with relatively high initial cost.

### 10.3.3. Advanced T/F Systems Using Radio Techniques

Varied types of advanced systems with primary or related time synchronization capability, have been operated and/or proposed within the last several years. Several of these such as very long base interferometry (VLBI), the "moon bounce" (lunar radar) synchronization method, and aircraft collision avoidance systems (ACAS) are considered briefly to acquaint the reader with their capabilities and characteristics.

**a. Very Long Baseline Interferometry (VLBI) Time Synchronization**

Within the last several years, a new technique of radio interferometry has evolved whereby a point source of radio radiation can be received and coordinated at independent antennas, separated by thousands of kilometers, through precise timing available with atomic frequency standards [183–186]. Initially, long baseline interferometry was used for precise angular measurements of extraterrestrial radio sources. The increased sensitivity of VLBI, resulting from long, widely-separated baselines with independent coherent time references at each end, gives impetus to various scientific experiments and proposals; included are studies of global geodesy, radio astronomy, tidal oscillations, continental drift, polar motion, earth rotation, relativity measurements, and global time and frequency synchronization [187–190].

Let's look initially at the basic concepts of VLBI. Figure 10.51 gives the geometry of VLBI in simplified form. Two antennas, Nos. 1 and 2, are separated on earth by a distance  $D$ , and this baseline forms an angle,  $\theta$ , within a line to the source of electromagnetic radiation. With extraterrestrial radio sources, the wave front is considered plane to the earth surface and traveling with the speed of light in a vacuum (disregarding at the moment atmospheric

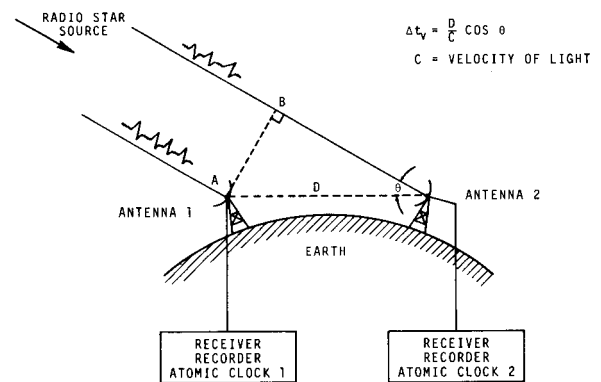

FIGURE 10.51. Geometry of VLBI receiving sites.

effects, etc.). At points A and B, the signals are identical; however, the phase of the received signals at antennas 1 and 2 will differ by the delay time,  $\Delta t_v$ . ( $\Delta t_v$  is a key factor in nearly all VLBI proposals and experiments, and its determination results from many measurements of various point sources at different observatories with a complicated statistical structure, involving many parameters.) Shapiro and Knight [188] point out, however, that the various geophysical effects proposed for study all have characteristic time variations in the observed  $\Delta t_v$ , and extraction of the estimated relevant geophysical quantities is feasible.

At a given antenna, the received signals are converted to video frequencies, tape recorded on magnetic tape, and time referenced to local atomic clocks. The recordings from two widely separated and independent receivers are then brought together and cross correlated through computer reduction and manipulation; maximum cross correlation occurs when the recordings are offset in time by  $\Delta t_v$  for the various frequencies of radiation (essentially microwave band), based on synchronous time sources at both antenna sites. Corrections are made for the earth's orbital motion and Doppler shifts from the earth rotation. In one series of measurements in January 1969, reported by Shapiro and Knight [188], an 845-km path separated the MIT 120 ft. (~37 m) diameter Haystack dish antenna in Tyngsboro, MA, and the National Radio Astronomy Observatory (NRAO) 140 ft (~43 m) diameter dish antenna in Green Bank, WV. The measurements were at L-band (1.6 GHz) of 24 hours duration, and included observations of sources 3C 273, 3C 279, 3C 345, and 3C 454.3. The experiment included 30 different measurements of  $\Delta t_v$  from these four distant objects to determine some 12 parameters. The error in determining each  $\Delta t_v$  was estimated as 1 ns, and the standard error in determining the baseline,  $d$ , as about 1.5 meter (5 ns). This is tempered with the statement that the "true error may be somewhat greater." Hydrogen masers were used at both receiving sites. The worldwide net of radio astronomy stations that have participated in VLBI experiments are shown in figure 10.52. More recently, VLBI experiments were performed at a baseline length of 8035 km between NRAO, Green Bank, WV and the Crimea Astrophysical Observatory on the Crimea peninsula, USSR [191].

With such promising results, it is not surprising that suggestions are made to use the VLBI technique in reverse to synchronize remotely located clocks; i.e., to provide precise *time transfer* via a common source [186, 188, 190]. Such a technique requires knowledge of the geometric delay,  $\Delta t_v$ . Thus, recordings of signals from a point source, received at two widely separated fixed points and referenced to precise frequency standards, could be time shifted to obtain maximum correlation. The

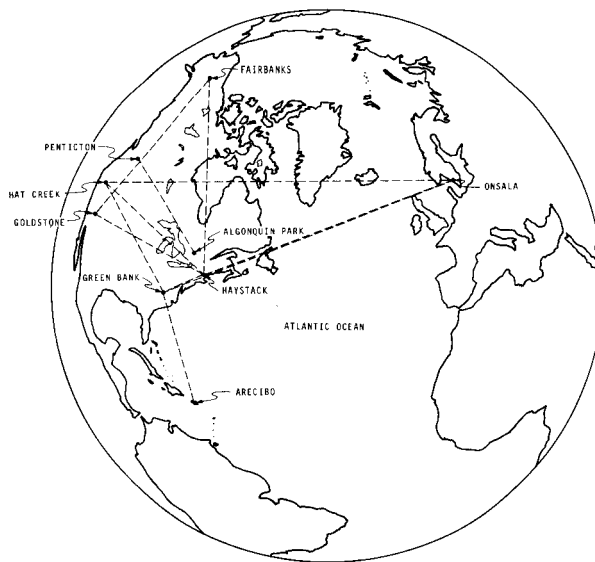

FIGURE 10.52. Worldwide net of radio astronomy stations participating in VLBI experiments.

difference between this time offset and  $\Delta t_v$  is essentially the clock difference. VLBI time synchronizations are limited by the precision in the  $\Delta t_v$  determinations; Rogers and Moran state that "without first using the interferometer as a survey instrument, the geometric delay can only be computed reliably to within 20 nanoseconds" [190]. Uncertainties in  $\Delta t_v$  occur from errors in estimating positions of both the source and receiving antenna as well as variable propagation delay of signals through the atmosphere [192]. It is predicted that intercontinental synchronizations of precise clocks can be made via VLBI techniques within the range of 1 to 50 ns [186, 190, 192]. Recently, frequency differences between two hydrogen frequency standards were determined as several parts in  $10^{14}$  through VLBI measurements over a 16-km baseline; (10-min to 4 h measuring period [193]). Lunar and/or satellite beacons as well as moon based antenna have been proposed for increased sensitivity of VLBI [188].

#### *Advantages of VLBI Clock Synchronization*

- Clock synchronizations to nanoseconds or better at widely separated intercontinental distances appear possible.
- Although the present VLBI systems are fixed-base, portable installations with transportable antennas 3–5 meters in diameter, could be situated globally for time synchronization purposes [194].
- At the 50-ns region the results are relatively independent of ionospheric and atmospheric effects [190]. Ionospheric effects can be reduced through the use of frequencies above ~5 GHz [195].

- The actual sync measurements require short integration times (in order of minutes), although the data reduction, correlation and processing may take days. Rogers and Moran [190], however, suggest that suitable HF links could be tied into a computer to obtain nearly real-time synchronization.
- Radio astronomy sites are geographically well known and already the installations include much of the equipment required for VLBI.
- Radio astronomy sites could provide primary time synchronization referenced to a national or international time scale.
- Clocks can be compared independent of physical transfer, and the synchronization possibilities could be extended to aircraft or ships at sea through appropriate communication links and computer facilities.
- Apart from clock synchronization, VLBI methods offer promise of precisely determining many geodetic and radio astronomical factors as well as relativity effects.

#### *Limitations of VLBI Time Synchronization*

- The system is elaborate, cumbersome and requires expensive instrumentation, such as high-speed, digital tape recorders, low-noise microwave receivers, and auxiliary equipment. In addition, the data must be reduced and cross correlated by computer analysis. Equipment costs, apart from computer time but including atomic clocks and dividers at an observatory with a large dish antenna is estimated at about \$145,000.
- The method is limited to the extent to which the geometric delay,  $\Delta t_v$ , can be determined. This determination is based upon systematic errors in source positions, receiving site locations, baseline length, and sidereal time.
- VLBI is subject also to errors from atmospheric delay caused by variation in water vapor content, ionospheric and plasma phase delays, signal to noise ratio of the receiving system, instability of atomic frequency standards during measurement (timekeeping for maintaining minimum "clock offset errors" between interferometer sites may require 8h clock stability of 0.1 ns; many measurements now are integrated over 3-min periods), and changes in antenna orientation. Minimum atmospheric errors occur when the zenith angle is small at both terminals; however, separations at inter-continental distances at various latitudes give different elevation angles at the receiving antennas, and high accuracy measurements at such locations would require atmospheric correction.
- The system cannot determine time through single frequency recording of a given radio

source, but requires wide band measurements to resolve the  $\Delta t_v$  factor through sampling many widely-separated narrow band frequency channels [196].

- Clock synchronization via VLBI is now at the experimental and proposal stage. While the technique shows great promise, much work yet remains in making measurements at many sites, encompassing diverse global baselines at different latitudes, from various extraterrestrial sources to adequately define the geometric delay,  $\Delta t_v$ , and to simplify the reduction and correlation processes of the data analysis.
- Clock synchronizations would be delayed after the fact.

#### **b. Moon Bounce Time Synchronization (MBTS)**

This technique, also called a lunar radar time synchronization system, was devised and designed by the Jet Propulsion Lab, Pasadena, CA [197-199]. The system is in operational use for deep space tracking and synchronizes clocks within  $20\mu\text{s}$  or better at 5 worldwide tracking stations with a master clock at Goldstone, California, through reflections of radar signals off the moon.

Basically, the MBTS method uses biphasic modulated, X-band radar (8.4501 GHz) signals which are transit-time and Doppler shift corrected, bounced from the moon, and received on time at tracking stations. A primary concept of the system stresses simplicity of the receiving antenna and the receiver operation at the tracking site; the moon must be simultaneously visible to both the transmitter and receiver for at least 10 minutes daily. This latter point coupled with the necessity of computer corrections for transit time and Doppler shifts at a given station, dictates that only one station can be synchronized at a given time period.

A simplified diagram of the MBTS system is shown in figure 10.53. Briefly, the essentials of operation are as follows:

- (1) The X-band transmitted signal is pseudo-noise (PN) modulated; it is both frequency-compensated for Doppler shifts at the receiver and time-advanced by 2-3 seconds for propagation time delay determined by a computer.
- (2) The PN code is transmitted at one minute intervals and scans  $\pm 30\mu\text{s}$  in  $1\text{-}\mu\text{s}$  steps.
- (3) The transmitted signal is directed at and reflected from the moon at an effective sub-radar point and received and compared at the remote station with a PN code generated by the local clock and identical to the transmitted code.
- (4) The offset between the received and locally generated code is determined by cross correlation between the two as shown on a strip

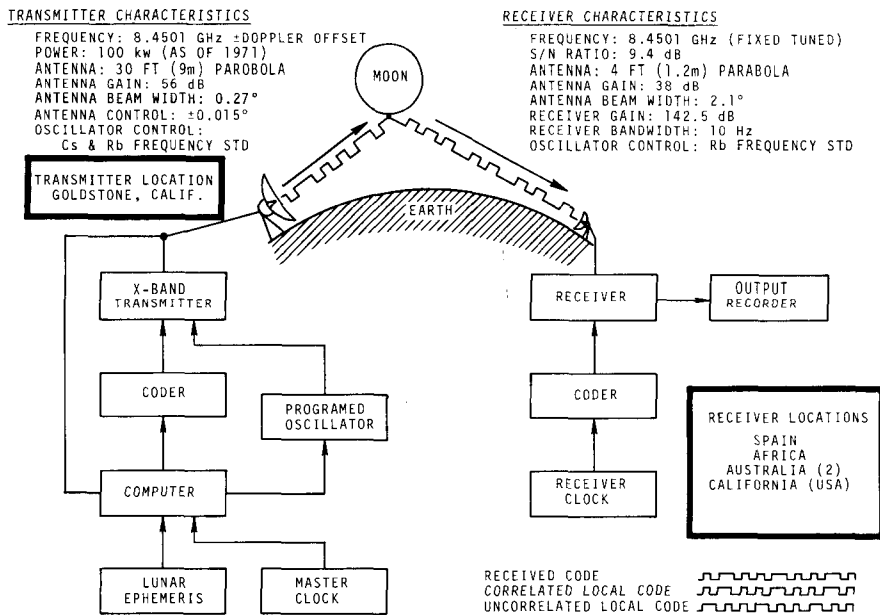

FIGURE 10.53. Simplified diagram of MBTS (Lunar Radio) system.

chart recorder at the receiver. Thus, maximum correlation occurs when the two codes are in coincidence; typically, this point occurs within the 60-second scan of  $1 \mu\text{s}/\text{second}$  ( $\pm 30 \mu\text{s}$  overall) and gives the time differences between the master and receiver, provided the propagation delays, Doppler shifts, etc., are correct. If the receiver clock has an error in excess of  $\pm 30 \mu\text{s}$  or if there is a clock failure, one can resynchronize to 10 ms through radio standard-time transmissions such as WWV. The Goldstone control facility can change the transmission code rate scan to 10 or  $90 \mu\text{s}/\text{s}$  thus giving a search range flexibility of up to  $5400 \mu\text{s}$ . This technique permits setting a clock within 10 ms of true time and synchronizing to the original accuracy of  $\sim 20 \mu\text{s}$  by scanning through 3 transmission periods.

Some interesting work reported by Higa and Ward [200] gives evidence of lunar topography causing fluctuations in the MBTS method. Librations of the moon cause the subradar reflection point to move from hills to valleys within the lunar period of 28 days; this front cap can be considered as a complex surface about 180 km in diameter which moves from day to day. Higa and Ward, through meticulous calculation, determined the varying altitudes of the equivalent frontal cap for a three-month period in 1970 and converted these distances to equivalent propagation delay times. At the same time, MBTS measurements were made between the Goldstone transmitter and a receiver at the USNO. Figure

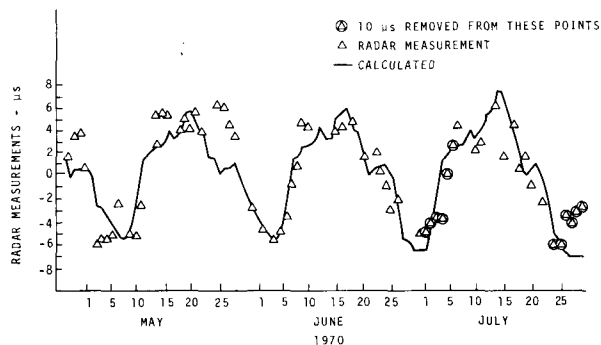

FIGURE 10.54. MBTS (Lunar Radar) results at Goldstone, CA (Courtesy Jet Propulsion Laboratory).

10.54 gives the results, and a very high correlation exists between the two sets of measurements. It is concluded that the MBTS accuracy can be improved from about  $\pm 20 \mu\text{s}$  to  $\pm 5 \mu\text{s}$  through corrections for lunar topography. Much work has been reported by JPL in the prototype work, implementation, and operational use of the MBTS method [201–203]. Higa lists advantages and limitations of the MBTS [198], some of which appear below:

*Advantages of MBTS for TFD*

- MBTS can provide  $\pm 20 \mu\text{s}$  accuracy as proven by portable clock measurements. With further improvement and lunar topography corrections the technique shows an accuracy potential of  $\pm 5 \mu\text{s}$ ; as such it could provide worldwide time synchronization to widely separated clocks.



- Varying ionospheric or earth atmosphere propagation effects have minimal influence on this TFD system.
- Receiving sites maintain atomic frequency standards and time scales which can provide  $\mu\text{s}$  timing related to NBS or USNO time to about  $\pm 10\mu\text{s}$  and can serve as time reference stations for portable clock calibrations.
- The moon is likely to hold its orbit indefinitely, its position can be determined and predicted with precision, and it passively reflects radio signals in contrast to the limited and inherent electronics of artificial satellite transponders.
- Accurate  $\mu\text{s}$  measurements require a relatively short time period (about 10 min).
- The receiver operation is simple and requires a minimum of man-power and maintenance. The complicated computer programming for continuously updating the ephemeris and Doppler delays is performed at the transmitter, and these functions are independent of the receiving site.
- The system is capable of resetting clocks on time provided rough synchronization to about 10 ms can be obtained by other means such as HF radio time broadcasts.

#### *Limitations of MBTS for TFD*

- Receiver systems are expensive (about \$50,000 per unit); however, Baumgartner [197] states a simplified receiver could be built for about \$15,000.
- The moon must be in common view of both the transmitter and receiver sites for T/F measurements. The time period of common views for worldwide sites can vary from  $\sim 10$  min to several hours per day; there are variations also at monthly intervals as well as every 19 years.
- Propagation delays must be known between the transmitter and a receiver site (ephemeris data) well in advance of measurements.
- Coordination with JPL and both the USNO and NBS would be required for time synchronizing a remote site via moon-bounce to UTC(USNO) and/or UTC(NBS).
- The system is subject to various systematic errors, such as ephemeris discrepancies (present accuracy can predict moon's center of gravity to 150 m which could cause a time error of about  $1\mu\text{s}$ ), variation in reflection points on moon (roughness), errors in station location, unknown equipment delays, code jitter and noise sources. The variance of all these errors is felt to fall well within  $\pm 10\mu\text{s}$  limits [204], however.
- Fixed station reception at known geographic sites is required for time synchronization; as such, system is unsuitable for synchronizing clocks at nonstationary or portable sites.

- Only one receiving station can be synchronized at a given time period.

#### **c. Aircraft Collision Avoidance System (ACAS)**

Disastrous collisions between flying aircraft over the past decades, coupled with ever-increasing aircraft congestion, have aroused much public concern and shown the need for better air traffic control. Culminating many years of research and development, the ATA (Air Transport Association—composed of airlines, manufacturers, and government representatives) has proposed a time and frequency collision avoidance system (TF-CAS) [205, 206]. In its present concept, the TF-CAS is complex, expensive and specialized. Because the system has varied and imminent potential for time and frequency dissemination for the non-aircraft user, it is included with a brief description. For in-depth detail, the reader is referred to publications in the open literature [207–211].

Basically, the proposed ATA CAS is cooperative (all aircraft are equipped and carry precision oscillators); will perform in aircraft densities  $> 1000$  in number within 250 miles ( $\sim 400$  km) or line-of-sight; and will protect aircraft operating at speeds as high as Mach 3, up to altitudes of 80,000 ft. (24 km). The system is T/F referenced and predicated on each participating aircraft maintaining time synchronization  $< 1\mu\text{s}$  [212, 213]. Prime synchronization is initiated by master ground stations; it can be maintained by ground stations and/or other aircraft through a hierarchy classification up to  $\sim 40$  units, which, dependent upon their time degradation, can give or receive time information.

The ATA proposal provides for a time-ordered format of 2000 message slots, each of  $1500\text{-}\mu\text{s}$  duration, repeated every 3 seconds. Each aircraft or ground station is assigned particular message slots (for transmission of their CAS data) which are switched sequentially at 5-MHz increments at L-band assigned frequencies in the range of 1.592–1.622 GHz. A simplified CAS fine time synchronization is diagrammed in figure 10.55. TF-CAS, relying on both precise time and frequency synchronization, automatically provides one way Doppler ranging, closing rate determination, and altitude difference measurements between aircraft. The basic criterion for determining collision potential is the “tau” ( $\tau_a$ ) parameter, the ratio of reported range to closing rate or time to nearest approach or collision projected under existing conditions. Its value is the key to no action, or positive instruction to either climb or descend with a warning period of 60 s or less. As presently conceived,  $\tau_a$  is only as good as the time synchronization of the on-board clocks, considered as a common time reference between aircraft ( $0.1\mu\text{s}$  insures ranging accuracy of about 100 ft. or 30.5 m). The system can use

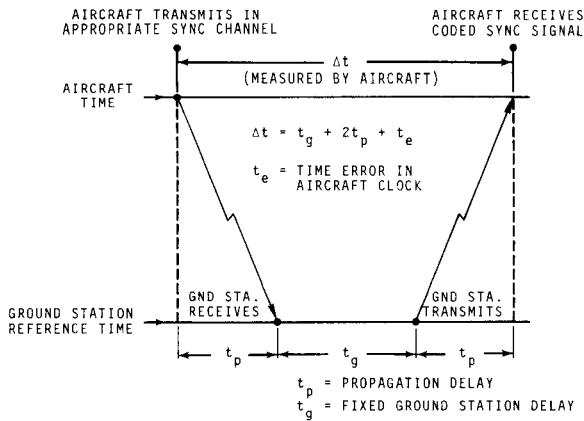

FIGURE 10.55. Simplified CAS fine time synchronization.

crystal clocks in aircraft (stability of  $1 \times 10^8$  or better), provided sufficient repetitive resynchronizations are made at least every 3-min to insure overall synchronization to  $\sim 2\mu\text{s}$  [214]. An atomic clock has recently been developed for airborne CAS which can extend resynchronization time to more than 28 hours [215]. Such clocks would be extremely valuable and almost necessary for long, oversea flights.

A commercial TF-CAS incorporating many of the ATA recommended features has been developed and shown successful operation since 1965 for some 17,000 flights, centered around one ground station [214]. As presently proposed, time synchronization is zoned around ground stations with other aircraft in the vicinity supplying backup synchronization. As a plane leaves a given zone, supposedly no time degradation would occur at resynchronization with a new ground station. It has been reported that a network of some 60 ground stations is planned by the FAA to adequately cover the continental U.S. [210]. Eventual worldwide networks are implied in the long range plans. A major problem will be the synchronization of such ground stations to within  $0.1 \mu\text{s}$  of each other, and considerable study is now occurring in this area [216]. A typical ground station timing system has been suggested by Perkinson and Watson [214] and is shown in figure 10.56.

Besides the collision avoidance, traffic control, and navigation/communication aspects of T/F-CAS, Perkinson and Watson also point out its potential for TFD [214]. Three particular areas are mentioned: (1) walk-in service; (2) passive reception; and (3) active participation. Ground stations, considered as reservoirs of precise standards referenced to national standards, could provide T/F synchronization of portable standards on a walk-in basis. The passive reception of CAS radio signals within line-of-sight of a ground station would provide a submicrosecond

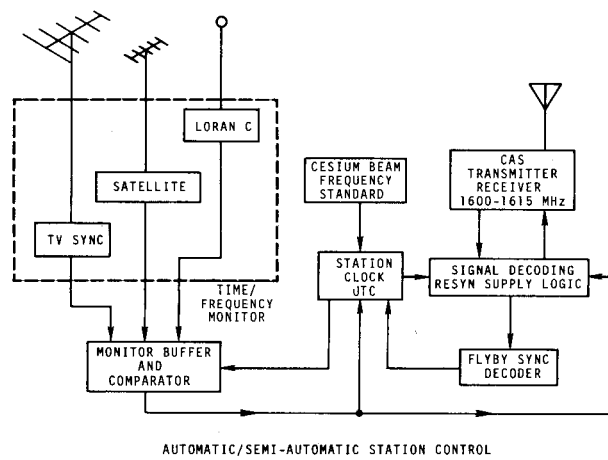

FIGURE 10.56. ACAS ground timing station.

time source, with calibration of the RF propagation time between the ground station and the user. A receiver and decode equipment for such use is estimated as costing  $\sim \$200$ . The third mode of operation might satisfy needs of automatic vehicular monitoring (AVM) [217], marine position fixing [218], and others requiring position of moving vehicles within range of a T/F-CAS ground station or overflying aircraft. In this case modified equipment, estimated to cost  $\sim \$1000$ , can actively participate in the TF-CAS and obtain fix position through trilateration and difference in arrival time calculations. A further consideration of TF-CAS is the precise clock intrinsic to each aircraft equipment. This provides an excellent potential for aircraft flyover T/F synchronization similar to that discussed in Section 10.4.2. If the system becomes operational in 8 to 10 years with both flying aircraft and ground stations synchronized worldwide to  $0.1 \mu\text{s}$ , it will have tremendous impact on time and frequency technology.

#### *Advantages of TF-CAS Time and Frequency Synchronization (partly from [214])*

- Synchronizations to less than  $1 \mu\text{s}$  appear feasible over large areas of the earth, either through line-of-sight  $\mu\text{wave}$  signals from ground stations or flying aircraft. Fail safe operation is assured and the coherent signals are transmitted at low power with little or no interference.
- Portable equipment can be synchronized due to the worldwide coverage of the synchronization network.
- At line-of-sight distances, propagation effects are minimal, requiring little or no correction.
- Receiving and comparison instrumentation should be relatively inexpensive, although there must be provision for decoding time ordered slots for time synchronization.

- TF-CAS provides a network for coordination and maintenance of a worldwide primary time scale such as the TAI.
- The time period required for synchronization is only of the order of minutes at the most, and initial clock setting appears possible.
- In some modes no physical transport of clocks is required.
- System could provide multilateral functions with T/F aspects such as surveillance, navigation, vehicular location, etc.

#### *Limitations of TF-CAS Time Synchronization*

- The system in its present form is expensive and requires complex instrumentation techniques (the best aircraft system is estimated to cost about \$50,000 [207], although cheaper, less versatile systems would be available).
- The system will not be operational for at least 8 to 10 years.
- The TF-CAS will require exquisite synchronization techniques with backup facilities for maintaining and controlling worldwide timing to about  $0.1\mu\text{s}$ .
- Reception is limited essentially to line-of-sight distance from a transmitter (aircraft or ground station).
- Possibility exists for multipath interference causing degradation of time synchronization.
- Some time variation may occur as a synchronizee changes references from one master station to another.

## 10.4. DISSEMINATION OF TIME AND FREQUENCY VIA PORTABLE CLOCK

The general method of transporting and inter-comparing frequency standards is not new. W. G. Cady, in 1923, made international comparisons of frequency standards by carrying portable piezo resonators to seven laboratories in Italy, France, England, and the United States [219]. He showed agreement between primary standards to about 1 part in  $10^3$ . From 1925 to 1927, the U.S. National Bureau of Standards made similar tests using quartz crystal oscillators and determined average agreement between frequency standards of five national laboratories in 1927 as about 3 parts in  $10^5$ . This informative comparison and the relation of accurate frequency to reduction of interference in the new field of radio are ably described by Dellinger in 1928 [220]. At about this same time, Marrison described the first quartz crystal clock [221], a precise timekeeping device which integrated or summed up recurrent cycles of accurate frequency generated by the crystal oscillator. He indicated the rate of

these crystal clocks to be stable to a few parts in  $10^7$  or approximately 10 ms per day. During the interim between the 1930's and the present day, many refinements and improvements were incorporated into quartz crystal standards. A bibliography of pertinent references is beyond the scope of this paper; much of the work has been reviewed in the literature [222-226] (see also chap. 2). A fundamental problem in quartz oscillators, still existing today, is crystal aging with time. Aging can be compensated to some extent, however, by drift correction [227].

In the late 1950's, commercial cesium beam standards were developed in which a quartz crystal oscillator was controlled, through electronic servo systems, to the atomic resonance of cesium. This provided the impetus for side by side comparison of atomic frequency standards of different construction. In 1958, two U.S. commercial atomic frequency standards were transported to the National Physical Laboratory in England and compared with the NPL laboratory atomic standard [228]. Agreement of several parts in  $10^{10}$  was shown with a measurement precision of several parts in  $10^{11}$ . In 1958, Morgan proposed synchronizing widely separated clocks by transporting a master clock to correct remotely-located slave clocks [84]. During 1959, Reder and Winkler organized a worldwide synchronization of atomic clocks by air-transporting commercial atomic standards to slave sites in the continental U.S., Hawaii, Australia, and South America [229]. Synchronization at the various stations was maintained between clock visits via phase tracking of VLF signals. These test results indicated global time synchronization via flying atomic clocks then to be about  $5\mu\text{s}$  [230]. The experiments also revealed areas for improvement such as reduction in the size and weight of the frequency standards, a decrease in power consumption, inclusion of standby battery supplies, modification of electronic divider circuitry, and a lessened sensitivity to rotational movements.

In 1962, a portable crystal clock was used to compare time scales between WWV at Greenbelt, Maryland, and NBS, Boulder, Colorado, with an overall time closure of  $5\mu\text{s}$  [231]. Dependent upon the timing requirements, cost limitation, and accessibility, the crystal clock can be very useful in time and frequency synchronization.

In 1964, a new portable cesium beam clock was developed which was considerably improved in size and weight characteristics; it also showed accuracy and stability approaching a laboratory standard, required low power with a standby battery supply, included a quartz crystal oscillator which of itself aged at a rate less than  $5\mu\text{s/day}$ , and was coupled to an electronic clock which integrated the cesium resonance frequency to give a true atomic time output and display [232]. A series of "flying clock" measurements, using these standards, were made

from 1964 to 1967 [233–235]. Standard time and frequency were correlated and compared at some 50 laboratories, observatories, standard frequency broadcast stations, etc., in 18 countries in Europe, Asia, Africa, and North America through this portable clock carrying technique. The 1967 experiment continued over a period of 41 days and the clocks were transported over a distance range of some 100,000 km. The time closure between the reference standard and the two portable clocks was several  $\mu\text{s}$ , corresponding to frequency differences of parts in  $10^{13}$  between the portable atomic standards. The time correlations on the 41-day trip were believed to be accurate to about  $0.1 \mu\text{s}$ . Time scale comparisons, made 16 months apart on two of these

experiments, between NBS and seven worldwide laboratories are given in table 10.13. An average time change of about  $50 \mu\text{s}$  in 16 months indicates an agreement of time scales to about 2 parts in  $10^{12}$ . Also, in 1967, Swiss portable atomic clocks (cesium) were flown to various time centers in the U.S., Canada, and the Far East for time comparisons. At the conclusion of these tests, one of the clocks showed a time closure of  $26.7 \mu\text{s}$  over a 255-day period when compared with the laboratory standard at the Cantonal Observatory [236]. Smaller and lighter weight cesium beam standards are being developed [215]; also, small portable rubidium clocks are available, however, little has been written about their use.

TABLE 10.13. *Differences between 7 International Time Scales and the NBS UA Time Scale for two comparisons made 16 months apart via portable clocks (from ref. [235])*

Laboratory	1966		1967		Change $\mu\text{s}$
	Date	Time Diff. $\mu\text{s}$	Date	Time Diff. $\mu\text{s}$	
Radio Research Laboratory (Japan)	18 May	1,474	16 Oct.	1,400	-75
National Research Council (Canada)	19 May	200,489	18 Sept.	200,557	+68
USN Observatory (USA)	18 May	79	11 Sept.	165	+86
Neuchatel (TUA) Observatory (Switzerland)	22 May	2,405	23 Sept.	2,468	+63
Dominion Ob- servatory (Canada)	20 May	1	17 Sept.	54	+53
Physikalisch- Technische Bundesanstalt (Germany)	3 June	<sup>1</sup> 433	26 Sept.	489	+56
Royal Greenwich Observatory (England)	3 June	59	4 Oct.	154	+95

<sup>1</sup>1966 time difference value corrected for known time scale frequency offset existing from 3 June to 30 December 1966.

### 10.4.1. On-site Visits

There have always been and presumably will be applications for time synchronization that exceed the capabilities of dedicated time dissemination services for coverage or accuracy. Portable clocks can be employed to meet requirements which are hard to satisfy by other techniques. Basically, a portable clock consists of a stable oscillator whose output is integrated or counted by a clock mechanism to indicate time. Typical outputs include standard frequencies such as 5 MHz, 1 MHz, and 100 kHz and time ticks such as 1 pps. The portable clock method consists of establishing the time of the portable unit (which may be a quartz crystal or atomic clock) in terms of the reference time scale prior to a clock synchronization trip. Usually, the clock is flown to a general area where the measurements are to be made, with intermediate transportation by auto. A typical scene in the transportation of a portable cesium beam clock is shown in figure 10.57. Self-contained batteries can maintain power for periods of hours. Time synchronization consists of bringing designated time pulses into coincidence or to fixed delay relationships. Frequency comparison can be made through phase intercomparison for a given time interval. At the conclusion of a trip the portable clock is again compared with the original time scale reference, and the time closure difference is distributed backwards as the deviation within which the portable clock measurements fall.



FIGURE 10.57. Example of portable clock carrying in Oslo, Norway during a 1966 clock synchronization experiment (photo courtesy of Hewlett-Packard).

The success of portable atomic clocks to bridge distance gaps between a master standard and user led the U.S. Naval Observatory (USNO) to establish in 1968 a master clock location and six worldwide time reference stations around the world [237].

(These station locations are shown in ann. 11.E.1 of chap. 11.) Reference atomic clocks at each of the time stations are available for precise time measurements which can be referred to the USNO master clock in Washington, D.C. Periodic portable clock measurements between the USNO master clock and the reference station clock show typical time closures of  $\sim 1 \mu\text{s}$  [238]. As the USNO and NBS UTC time scales are mutually coordinated within  $\sim 5 \mu\text{s}$  of each other [239] clock synchronizations at the USNO time reference stations can also be related to the NBS time scale within this tolerance (or even better post facto). The effectiveness of portable clock carrying has been demonstrated by the periodic synchronization of some 21 worldwide laboratories or remote sites as reported by the USNO over the last several years [43].

General methods of maintaining synchronization at remote stations between portable clock checks include VLF phase tracking, navigation system comparison, satellite comparisons, and TV measurements as discussed in detail in Section 10.3.2. In consideration of the portable clock method of time and frequency dissemination, we list below both advantages and limitations of the method:

#### *Advantages:*

- Provides a means of microsecond time synchronization of remote clocks without a dependent link to a master clock with attendant delays and propagation errors as in radio methods.
- A minimum of manpower is required, and the synchronization can be simply and quickly performed with the usual equipment found in a standards laboratory.
- The portable clocks are relatively lightweight, rugged, and have a power operation versatility from either internal standby batteries or ac/dc current; such flexibility maintains accuracy, stability, and reliability over long periods of time.
- The portable clocks are easily transported by commercial airlines and automobiles.
- Newer portable cesium beam standards are relatively insensitive to shock and vibration, smaller in size, and lighter in weight.

#### *Limitations:*

- The most accurate portable clocks are expensive, and the method requires physical transportation of the clocks, which of itself can be a monetary concern. The accuracy obtainable is directly related to the cost of the clock.
- The clocks are usually hand-carried and, although experience has indicated high reliability, there is possibility of clocks stopping or changing rate en route due to power outages, excessive vibration, or environmental changes of temperature, humidity, or air pressure.
- It is difficult or impossible to make portable clock side-by-side measurements at some loca-

tions such as inaccessible islands, mountain stations, beacons, ships, etc. (The aircraft flyover technique may be used in some of these instances, however, see following sec. 10.4.2.) Auxiliary equipment is required to maintain synchronization between clock settings.

In summary the best clock for a particular application is not necessarily the most expensive or accurate clock available. Specific need, environmental conditions, budgets, and other considerations may all interface to dictate the optimum choice and/or compromise for a given portable clock measurement. The cost of portable clock comparisons may decrease in the near future with the availability of a new and smaller cesium beam portable clock [215].

### 10.4.2. Aircraft Flyover

Another method of time synchronization is a refinement of the portable clock technique. In aircraft flyover, planes carry an atomic clock and transmit a coherent time signal to synchronize a time scale at a receiving site. The method dispenses with cross-country and local transportation, reduces the time required to synchronize many remote locations, and affords the opportunity to synchronize inaccessible sites such as mountain or island stations, ships, other aircraft, etc. Some aspects of

this method were considered in connection with early aircraft collision avoidance studies. The method was first reported by Markowitz [240] and was recently refined by Besson [241]. The basic technique of aircraft flyover synchronization is illustrated in figure 10.58. The S-band transmissions (2.2 to 2.3 GHz) are amplitude modulated at a peak power of about 50 W. The pass band is 10 MHz. The time scale is coded and sent at a 10-Hz rate permitting 10 time scale measurements per second. The receiving site uses a counter with 10- $\mu$ s resolution and a readout which prints the deviations between the radio-received time scale and the local time scale 5 to 10 times per second.

Aircraft flyover determines the clock difference between the ground station time,  $H_G$ , and aircraft time,  $H_A$ , which is shown to be

$$H_G - H_A = (H_G - H_{A'}) - (\tau_{TR} + \tau_p), \quad (10.7)$$

where  $H_{A'}$  = received aircraft time at ground station;  
 $= H_A - (\tau_{TR} - \tau_p)$ ;  
 $\tau_{TR}$  = time delay of transmitter-receiver equipment (nearly constant);  
 $\tau_p$  = time delay for aircraft signal to reach receiver, dependent upon aircraft location relative to receiver.

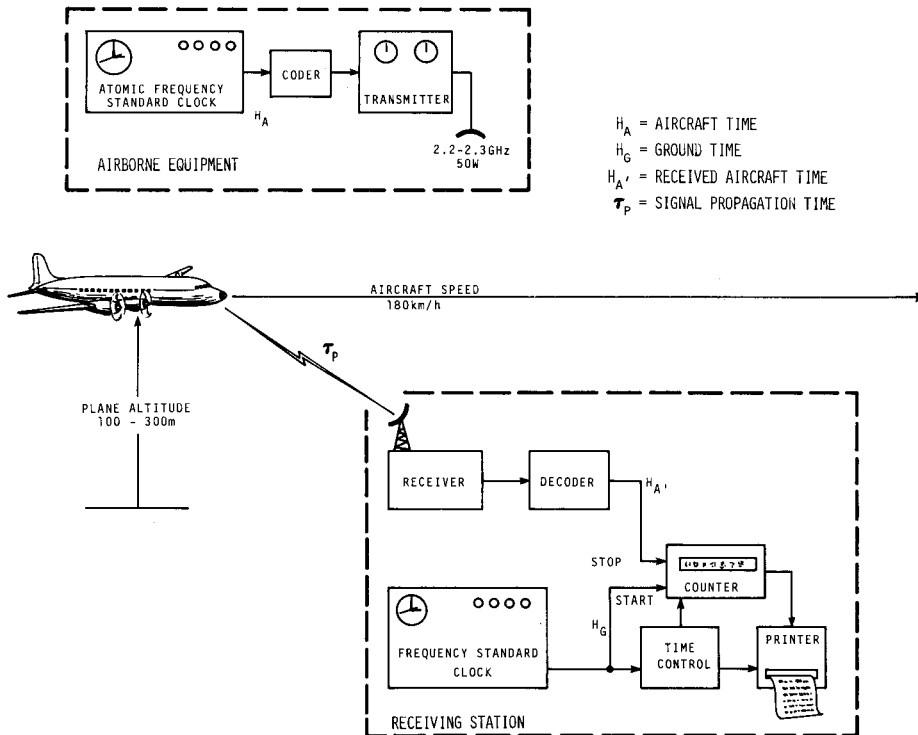

FIGURE 10.58. Aircraft flyover method of T/F comparisons.

The evaluation of  $\tau_{TR}$  and  $\tau_p$  should resolve the time scale deviations, ( $H_G - H_A$ ). Two methods have been proposed.

*Method 1.* This is a one-way system in which the aircraft passes over the site to be synchronized at low altitude (100–300m) at a flight speed of about 50 m/s and transmits timing pulses. The observed time scale difference,  $H_G - H_A$ , approaches a minimum as the aircraft reaches the point directly over the receiver and then increases as flyover continues. The minimum reading corresponds to the vertical distance between the aircraft and receiver and is the true altitude recorded by the aircraft instruments. This critical distance point should not exceed  $10^\circ$  from perpendicularity. Besson indicates that with a transmission rate of 10 sync pulses per second and a 3-percent altitude error, the propagation time standard deviation,  $\Delta\tau_p$ , is 30 ns or less. The instrumentation delay standard deviation,  $\Delta\tau_{TR}$ , is reported as 10ns or less [241].

*Method 2.* This technique is a two-way system involving simultaneous transmission by both the user and the aircraft so the propagation time delay,  $\tau_p$ , drops out of the equation for clock time difference. The aircraft does not have to fly directly over the receiver at a fixed altitude. Limitations in the two-way system include the degree of accuracy to which the time scale deviations between the aircraft and ground station clocks can be measured in the short time available and the difficulty of measuring the equipment delays at both time sources.

In September 1970 the French group (Office National d'Études et de Recherches) cooperated with several globally located time centers and made an international comparison of atomic clock scales through aircraft overflight. The experiment plan included both one- and two-way type of comparisons with three or four overflights of each time center. A nonstop one-way flight was expected to take about 18 hours. The experiment, named Synchran (North Atlantic Synchronization), was performed during the period September 9–15, 1970. Corrections included propagation delays, instrument factors, clock drifts, and relativity effects. The results show that aircraft flyover has many attractive features in rapidly intercomparing time scales at remote points with standard deviations typically 30 to 40 ns [242].

*Advantages of aircraft flyover time dissemination include:*

- Rapid precise synchronization of many intercontinental clocks without physically transferring clocks; provides a means of quickly evaluating the TAI.
- Enables clock synchronization at remote sites inaccessible to physical clock-carrying.

- The over-all short duration of worldwide comparisons lessens the possibility of clock failures and enhances the probability of successful clock comparisons.
- Insignificant propagation degradation with line-of-sight microwave frequencies.

*Disadvantages include:*

- Method is expensive; it requires the use of aircraft and auxiliary equipment such as transmitters, receivers, etc.
- Clock synchronization at a given site requires auxiliary techniques to maintain accurate time between clock comparisons.

## 10.5. TFD VIA OTHER MEANS

The following TFD methods are unique in that conventional radio waves are not involved in carrying the timing information. The methods include optical pulsar signals, telephone/coax cable transmission, and ac power lines. The techniques are characterized by some of the most complex as well as simplest noted in this dissemination overview.

### 10.5.1. Time Transfer via Optical Pulsar Signals

The precise periodicity of pulsar radiations can provide a means of time transfer to remote points on earth. Pulsars are believed to be rapidly rotating neutron stars which periodically emit a narrow beam, like a lighthouse, each time the beam intercepts an observer [243, 244]. Neutron stars consist of tightly packed neutrons with a mass approximately that of the sun but a radius of less than 30 km [245]. First discovered in 1967 [246], there are now about 60 such identified bodies [247]. A striking characteristic of today's known pulsars is the variability of their periods; these range from 33 ms to about 4 s with the average about 1 s [245]. After months of study it was found that the periods of pulsars are increasing; i.e., the apparent pulsations are slowing down and those rotating the fastest at the greatest rate. The slow-down rates vary from about 40 to 0.3 ms per day [243]. Initially, all pulsar received-signals were from radio sources; in 1968 and later it was discovered that the Crab Nebula Pulsar (NP 0532) exhibits similar pulsations and structure at radio, optical, and X-ray frequencies [248–251]. (As of 1972 the Crab Nebula pulsar is the only such body known to be radiating optical wavelengths.)

The Crab Nebula was found to contain the fastest rotating pulsar—namely the NP 0532—which flashed about 30 times a second. This body is ~ 6600 light years distant and believed to be the remnant of a supernova explosion observed by Chinese astronomers in 1054 AD [243]. NP 0532 shows a mean pulse

period of 33.105 ms (November 1969–April 1970) [252] with a slow down of  $\sim 36.5$  ns per day ( $\sim 4$  parts in  $10^4$  per year in terms of the mean period) [243]; its emitted optical signal consists of both a major and minor pulse separated by  $\sim 14$  ms. In terms of power emitted, the optical flux is roughly  $10^2$  greater than the radio flux; the X-ray flux exceeds the optical by  $\sim 10^2$  [243].

The absolute times of arrival of optical pulsar signals has been determined to an accuracy of several  $\mu$ s (UTC) by Papaliolios et al. [250], who also suggest that time-of-arrival measurements of pulsar signals would enable clock synchronizations to several  $\mu$ s at any two observatories with at least 24-in (61-cm) telescopes observing the Crab Pulsar. Recently, Allan has shown this possibility of transferring time in the  $\mu$ s range between two widely separated points on earth via near-synchronous reception of the NP 0532 pulsar optical signals [253]. He analyzed pulsar reception data from the Lawrence Radiation Laboratory (LRL), Berkeley, California, and Harvard University, Cambridge, Massachusetts, which were compared previously [254]. The basic data were obtained at one end of the link by a method similar to that diagrammed in figure 10.59. Several thousand pulsar optical emissions, received by a phototube at the focus of a telescope, are amplified, enhanced, and averaged by a signal averager to improve the SNR. The signal averager scans the phototube signals at the simulated pulsar rate via a synthesizer referenced to a precise reference clock. The output of the signal averager gives the time interval between the pulsar

arrival time and the local clock. To evaluate the pulsar time transfer system, differences were taken in pulsar arrival times at Harvard and LRL for two periods in 1970 (adjustments in the raw-data were required to provide a commonality in the reduced data). The data difference took the form:

$$T_H(t) - T_L(t') \approx \Delta T(t), \quad (10.8)$$

where  $t$  and  $t'$  represent the local clock times at Harvard and LRL, respectively, on nights of mutual observations. Both the Harvard and LRL local clocks were referenced to the same time scale via the Loran-C East Coast system and an atomic clock at Santa Clara, California, respectively. The stability of the differential data was determined as follows:

$$\frac{\Delta T(t + \tau_s) - \Delta T(t)}{\tau_s} = \frac{\delta\nu}{\nu}, \quad (10.9)$$

where  $\tau_s$  is the time interval between nights of mutual observation of the pulsar signals. A data plot of such differential fractional frequency deviations between the Harvard and LRL clocks versus sample time is shown in figure 10.60. The dashed line approximates a fit for the data and indicates an rms time error of  $\sim 13\mu$ s; the slope of the line, inversely proportional to the sample time, provides evidence that uncertainties of the pulsar reception times are influenced by white noise statistics.

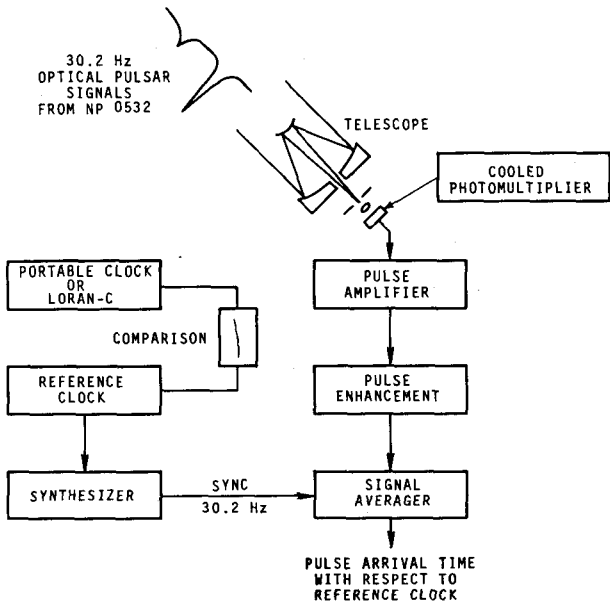

FIGURE 10.59. Method of time transfer via optical pulsar pulses.

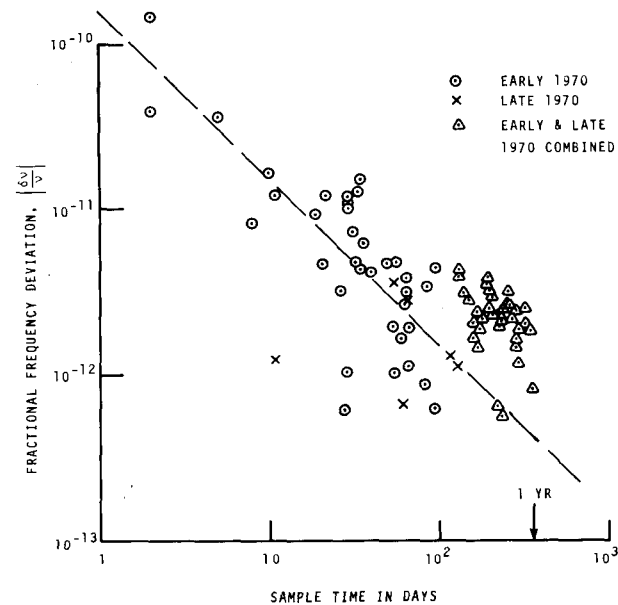

FIGURE 10.60. Differential fractional frequency deviations between Harvard and LRL clocks vs. sample time via optical pulsar signal NP 0532.



There are indications that nonuniformity of determining the arrival times at the observatory sites, as well as equipment differences, adversely affected the data analysis.

*Advantages of Pulsar Optical Time Transfer TFD:*

- The pulsar time transfer technique offers both accuracy and precision in the  $\mu\text{s}$  region on a global basis. (A resolution to  $\sim 2\mu\text{s}$  is believed possible at a 2-h sampling time using a 24-in (61-cm) diameter telescope [253].)
- The propagation effects for pulsar optical emissions are minimal; the earth's atmosphere increases the delay by  $\sim 10$  ns, and the spinning earth delay is  $< 8$  ns if the earth position can be known to  $< 5$  ms (1500 km).
- Pulsar photons are natural events which can provide a free source for time transfer without interference to or dependence on man-made systems.

*Limitations of the Pulsar Optical Time Transfer Technique:*

- Measurements can be made only at night; measurements are not possible during the latter part of May, all of June, and early July because at these times the source is within a few degrees of the sun.
- The signal strength of pulsar emissions at the earth is low, and relatively expensive equipment is required for detection and comparison ( $\sim \$20,000$  without telescope and atomic clock).
- Comparisons are restricted to fixed locations housing telescopes and required instrumentation.
- The data analysis for time synchronization requires computer techniques as well as communications between comparing sites or observatories. Measurements should be made simultaneously or nearly so for optimum results.
- Cloud cover severely affects the effectiveness of pulsar time transfer.
- Pulsar period show jumps because of quakes or sudden disturbances [250], and this could cause errors in extrapolated sampling rates for the signal averager.

**10.5.2. TFD in Telephone Line and Coax Cable Transmission**

Telephone lines and/or coax cables often are used for time and frequency distribution between closely spaced points ( $\sim 1$  to 30 km). This section briefly reviews the properties and characteristics of such hardware systems for TFD.

a. *Telephone Line Distribution.* In 1965 the Naval Research Laboratory (NRL) in Washington, D.C., used underground balanced land lines (broadband—100 to 15,000 Hz) to carry a 10-kHz signal, derived from a hydrogen maser, for comparison with atomic frequency standards at the USNO [255]. This dedicated line was 16 km in length one-way and

passed through no switching centers. Narrow band amplifiers were used at each end of the line to improve the SNR and isolate the output. The 10-kHz signal was stable in frequency to better than 1 part in  $10^{12}$  as transmitted. The same signal, returned from the USNO, was compared with the NRL transmitted signal to determine the effect of the telephone line on the transmission. The phase differences were found to be  $< 1\mu\text{s}$ , and averages over a 24-hour period gave frequency errors to  $< 1$ -part in  $10^{12}$ . Notice that these telephone lines were underground and thus at fairly constant temperature.

In 1966 Koide also described the use of multipair telephone lines for TFD [256]. He transmitted a 1-kHz standard frequency over leased multipair telephone lines, extending 37 km one-way. (Some tests were run two-way for a total path distance of 74 km.) This line, from Downey to Anaheim, California, was routed about halfway underground and the remainder by pole suspension in air; the voice grade line was without loading coils or repeater amplifiers. Each multiplier telephone cable consisted of four pairs (three different wire sizes) with each line showing a SNR  $> 50$  dB at 1 kHz; at the terminals the crosstalk between adjacent lines was attenuated  $\leq 40$  dB. It was found that daily temperature changes caused diurnal phase shifts in the transmitted 1-kHz signal similar to diurnal ionospheric effects in VLF/LF propagation. From relationships of the 1-kHz phase change vs. temperature change, and changes in temperature versus dc resistance of the telephone line, it was possible to determine the resistance change versus the 1-kHz phase change. Illustrative simultaneous plots of dc resistance and phase change over the two-way, 74-km telephone path are shown in figure 10.61. These plots show that the dc phone line resistance correlates directly with the phase changes, and there is significant phase delay during the nighttime transmission.

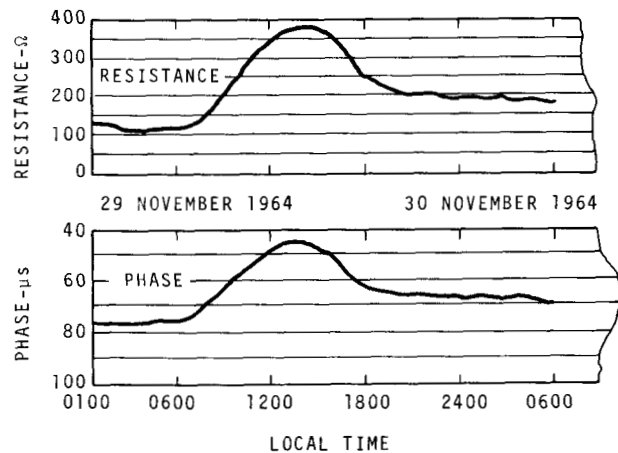

FIGURE 10.61. Diurnal changes in resistance of phone line and transmitted 1-kHz phase, caused by temperature change.

Figure 10.61 indicates an increase in dc resistance of  $\sim 285 \Omega$  caused a phase retardation of  $30 \mu\text{s}$  over a 6-hour period. Over a 4-month period the dc resistance-phase sensitivity averaged somewhat less; i.e.,  $8.3 \Omega$  per  $\mu\text{s}$  over this telephone path.

With such information it was possible to design an Automatic Phase Corrector (APC). This device, placed at the transmitting end of the line, sensed the dc resistance change in the telephone line and, through a Wheatstone bridge and servo potentiometers, maintained a null in the bridge; the servo simultaneously drove a phase shifter which corrected the transmittal signal an amount proportional to the resistance change. A round trip evaluation showed a corrected phase variation  $< 0.5 \mu\text{s}$  for a 12-hour period in which the actual phase in an adjacent line varied from  $-24$  to  $+18 \mu\text{s}$ . This correction is equivalent to a frequency offset of  $\sim 1 \times 10^{-11}$ . On short underground telephone lines (2–3 km in length) Koide has used various carrier frequencies from 1 kHz to 1 MHz; the higher frequencies showed stability and noise degradation coupled with much greater attenuation [257]. Typically, 22 gauge wire shows  $\sim 5$ -dB attenuation per 1.61 km at 10 kHz [258].

In comparing frequency standards at the Mt. Stromlo Observatory in Australia, Grimsley and Miller report the transmission of a 10-kHz standard signal over a 12-km landline ( $\sim 10.5$  km underground and 1.5 km in air) [259]. During a 40-hour period with a temperature variation of  $-1^\circ$  to  $+16.5^\circ \text{C}$ , no diurnal effect was noticeable in the received signal; a phase comparison between a rubidium standard and a crystal oscillator at nearly equal frequency indicated no frequency errors  $> 1 \times 10^{-11}$  resulting from the telephone transmission.

The WWV standard time and frequency broadcasts are now available via telephone by dialing (303) 499-7111 (Boulder, Colorado). The telephone signals are the live broadcasts as transmitted by WWV. Propagation and equipment delays limit the accuracy of these telephone signals to  $\sim 30$  ms or better as received anywhere in the continental USA [64]. A service call is automatically limited to 3 minutes.

b. *Coax Cable Distribution.* Information on the use and stability of coax cable is limited; we will review several examples in the literature. In 1945–46, phase comparisons were made in England between spaced aerial systems via coax cable from London to Birmingham, a one-way distance of 163 km [260]. The primary signal frequency was 1 kHz, and the standard deviation of the phase change over the entire loop (326 km) for periods of several weeks was  $7^\circ$  or  $\sim 20 \mu\text{s}$ . There were unspecified long and short period variations, and it is unknown whether the cable was underground. Tolman et al. [111] used a coax cable link  $\sim 340$  km long in connection with microwave TV time comparisons in 1965 and determined agreement to  $2 \mu\text{s}$  irrespective of the transmission medium used.

Koide mentions the use of coax cable in the distribution of standard 100 and 1000-kHz signals for slaving electronic counters (external time base signal) and timing clocks within a manufacturing/engineering laboratory [257]. He used coax lengths up to  $\sim 180$  m for distribution within buildings and employed coax impedance transformers. Frequency checks over such lines, using an Rb atomic standard, indicate that the coax cable contribute errors  $\leq$  parts in  $10^{10}$  [258].

At the Jet Propulsion Laboratory (JPL) in California, coax cable is used to distribute precise 1 pulse per second (pps) signals over short distances between distribution amplifiers and microwave transmitters at the Goldstone tracking facility [261]. About  $100 \mu\text{s}$  in duration, and with a risetime near 200 ns, such pulses were degraded little by the coax distribution; a combination coax-microwave system (base bands  $\geq 2.5$  MHz) transfers such pulses with an uncertainty of  $\pm 3 \mu\text{s}$ . In a typical installation the coax cables were run underground via constant-temperature cable tunnels, avoiding diurnal degrading effects.

Leschiutta recently reported impressive test results for transmission of phase data over coax lines between Rome and Turin, Italy—a distance of  $\sim 740$  km [120]. Phase changes from diurnal temperature variations were avoided since the cable and associated amplifiers were underground at a depth  $> 1$  meter. A stabilizer carrier frequency of 300 kHz was transmitted from Rome; received at Turin it was continuously compared with a synthesized 300-kHz signal from a local frequency standard. Such a system is calibrated every third month and within the last several years has drifted  $< 100$  ns. The received signal shows white phase noise for time intervals 10 ms to 10 s; for  $\tau = 1$  s, a fractional frequency stability of  $\sim 3 \times 10^{-9}$  was shown. The transmitted data were subject to random jumps of 30 and 50 ns, probably caused by line connections or amplifier changes. Such jumps are inconsequential on the stability measurements for long term. Comparisons of transmitted time and frequency data over the coax line and a nearly identical TV path (microwave link using eight relay stations) yielded a difference usually  $< 3 \mu\text{s}$  over measurement periods of 100 days. Part of this difference is attributed to propagation delay variations in the radio links.

#### *Advantages of Hardwire Distribution Systems for TFD*

- Dedicated telephone lines offer a relatively inexpensive means for distributing standard frequencies (1 to 10 kHz) between points  $\sim 30$  km apart at accuracies  $\leq 1 \times 10^{-10}$ . (Monthly lease charges approximate \$2 to \$3 per airline mile for a two pair-four line circuit.)
- Underground telephone lines require little maintenance and show minor temperature-caused phase variations in transmitted signals.

- Precise time pulses can be transmitted over coax cable for relatively short distances with little degradation with care, provided pulse shaping techniques are used. Underground coax cable shows excellent stability for transmission of standard frequencies ( $\sim 300$  kHz) over relatively long distances ( $\sim 750$  km).
- Reliability and percent-of-time available factors are excellent for hardwire systems.
- WWV telephone signals can provide time to  $\sim 30$  ms anywhere in continental U.S.

#### Limitations of Hardwire Distribution TFD Systems

- Aerially mounted hardwire systems degrade the transmitted precision signal because of temperature-related variations of the line dc resistance. Precise TFD via hardwire requires undergrounding of all transmission cable.
- Auxiliary equipment such as automatic phase correctors (APC), amplifiers, and filters are required for transmission and recovery of signals over long telephone lines in the open air.
- The signal attenuation per kilometer increases with frequency and is a practical limitation to the use of frequencies higher than 100 kHz in many cases. The lines are distance-limited for a given frequency because of signal attenuation.
- Coax cables may be impracticable for T/F distribution for distances much greater than several hundred meters because of the high cost of either initial purchase or monthly lease.
- As opposed to radio coverage, hardwire systems are inflexible to the extent that coverage is limited to those users connected into the system.
- For T&F distribution, telephone lines must be dedicated to this sole transmission; they should be balanced, unloaded, without repeaters, and bypass switching centers. The telephone TFD cannot tolerate unknown and variable delays from these latter factors.
- It is impractical to transmit timing pulses with high precision over telephone lines because of band pass limitations.
- Underground hardwire systems require a constant ambient temperature environment for highest precision.

#### 10.5.3. Power Line (60-Hz) Signals as a Time Transfer Technique

Large a-c power utilities in the continental U.S. are divided into a network of interconnected systems serving major portions of the country [262]. The American Electric Power (AEP) Company at Canton, Ohio, synchronizes and manually controls the electric time of these grids with a tolerance of  $\pm 2$  seconds; offsets of the 60-Hz frequency in steps of  $\pm 0.02$  Hz compensate for time errors [7]. The time and frequency reference for most of these networks is the NBS 60-kHz broadcast from Ft. Collins, Colorado. (Cohn proposes automatic and continuous

time error control through use of NBS standard frequency broadcasts in all power areas [263].) Time coordination enables efficient transfer of power from one area to another (load diversity) without inadvertent interchange time accumulation.

The U.S. coast-to-coast interconnected power grid is essentially a phase coherent system. Allan et al. have shown its potential as a time transfer system [264]. We will describe several of their examples. Initially, they studied the fractional frequency stability of the 60-Hz power signal at the NBS Laboratories, Boulder, Colorado. In using  $\sigma_y(\tau)$  (square root of an Allan variance [129, 130]), it was determined that the data exhibited flicker noise frequency modulation (see chap. 8) over a  $\tau$  range of 17 ms to  $10^5$  s and at a  $\langle \sigma_y^2(N, T, \tau, f_h) \rangle^{1/2}$  range of  $\sim 5 \times 10^{-5}$ . Similar results were obtained for measurements on different dates.

Another study compared the 60-Hz power line phase in California and Colorado relative to atomic clocks at the Hewlett-Packard (HP) Laboratory, Santa Clara, California, and at the NBS, Boulder, Colorado. Part of these data are plotted in figure 10.62, and strong phase correlation exists for the

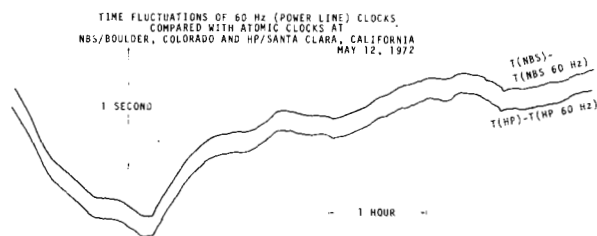

FIGURE 10.62. Comparison of 60-Hz (power line) clocks and local atomic clocks at Boulder, CO and Santa Clara, CA.

two distant sites in different interconnected systems [264]. A study of the differential delay,  $\tau_D$ , between Santa Clara and Boulder (determined by differencing the first zero-crossing measurements of the 60-Hz signal following a given second tick at each site) gave a fractional frequency stability of 1 part in  $10^8$  for  $\tau = 1$  day. Similar data for longer periods of time suggest that two remote clocks, located at distant points within different grid networks, could be kept within 1 ms, provided the particular path was calibrated.

Day-to-day synchronization requires that no cycle slips occur between measurement points. Tests were run, using dividers which generated precise 1 pps from the 60-Hz signal, and no cycle slippage occurred between three sites (Santa Clara, CA; Boulder, CO; and Ft. Collins, CO) over an interval of several days with continuous power. A plot of the fractional frequency stability versus averaging time

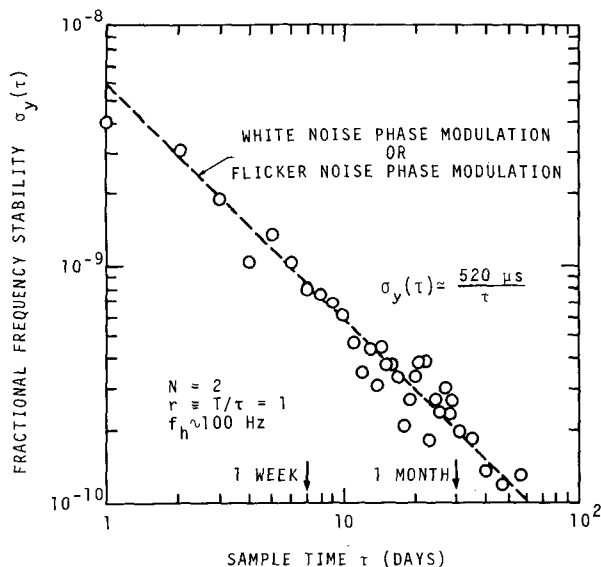

FIGURE 10.63. Fractional frequency stability vs. averaging time for 60-Hz power frequency between Santa Clara, CA and Boulder, CO.

of the Santa Clara-Boulder path is shown for 60-Hz power line data in figure 10.63. The 60-Hz stability data for the shorter WWV-Ft. Collins to Boulder path shows an improvement by a factor of 6 over the longer Santa Clara-Boulder path. Although the stability degrades with distance, stability of clock measurements of several ms may be possible across interconnected power systems throughout the continental U.S.

#### Advantages of a-c Power (60-Hz) for TFD

- Equivalent precision to WWV received sky-wave signals is possible from 60-Hz power line signals via the differential mode. (The WWV time signals are much more accurate than 60-Hz power line signals.)
- The 60-Hz time transfer system utilizes exceptionally cheap receivers (e.g., ~ \$20 for a low pass filter and transformer).
- The a-c power is continuously available to wide areas throughout the continental U.S.; the power grids of the U.S. are interconnected and synchronized to form a phase coherent system.
- The ambiguity of 16.67 ms could probably be resolved nearly everywhere in the USA via the WWV audio telephone signal, (303) 499-7111.

#### Limitations of the 60-Hz Power System for TFD

- The stability of the 60-Hz power system degrades with distance.
- Local area power outages or phase shifts occur, which can cause errors in the clock comparisons.

- The ambiguity of the 60-Hz power system is 16.67 ms.
- The system does not provide precise or accurate timing for the sophisticated user.

## 10.6. T/F USER AND SYSTEM EVALUATION

Having described the varied means of TFD, we would now subjectively classify real and potential T/F users as well as evaluate the various T/F dissemination systems and techniques. Three classes of users in terms of accuracy requirements are discussed below; the evaluation of systems provides direct comparison in some ten pertinent categories.

### 10.6.1. Classification of T/F Users

It is convenient to classify users of time into three categories: low accuracy (coarser than 1 ms); intermediate (1 ms to about 50  $\mu$ s); and high accuracy (more stringent than 50  $\mu$ s). Figure 10.64 illustrates the time accuracy requirements of some users below the time scale line and the normal capabilities of representative time dissemination techniques and services above the reference line. The accuracy obtainable by a given technique varies considerably with the location and skill of the user.

The low accuracy group contains the largest number of users; their needs are generally met by telephone time-of-day service, telephone access to WWV, commercial radio time announcements, and standard time emissions (WWV, CHU, JJY, etc.).

The intermediate group is fast growing. Organizations engaged in satellite geodesy, seismic monitoring, and satellite tracking require time in the intermediate accuracy range. The basic characteristics of reliability, geographical coverage, availability of signals, accuracy propagation predictions, and equipment costs relevant to needed accuracy have been explored largely in response to this group's needs.

High accuracy is required by coherent detection communication systems, long baseline interferometry facilities, and organizations engaged in precision ranging. Submicrosecond accuracy is generally sought by laboratories with clocks capable of maintaining time at that level. The proposed T/F aircraft collision avoidance system, for instance, requires widespread dissemination of time with submicrosecond accuracy [214]. Reliability, percentage of time available, coordination among facilities and systems, and worldwide coverage are of paramount importance to system designers in the high accuracy group. Although the number of time users who have present requirements for submicrosecond accuracy is relatively small, these are not negligible and can be met with sophisticated but expensive techniques.

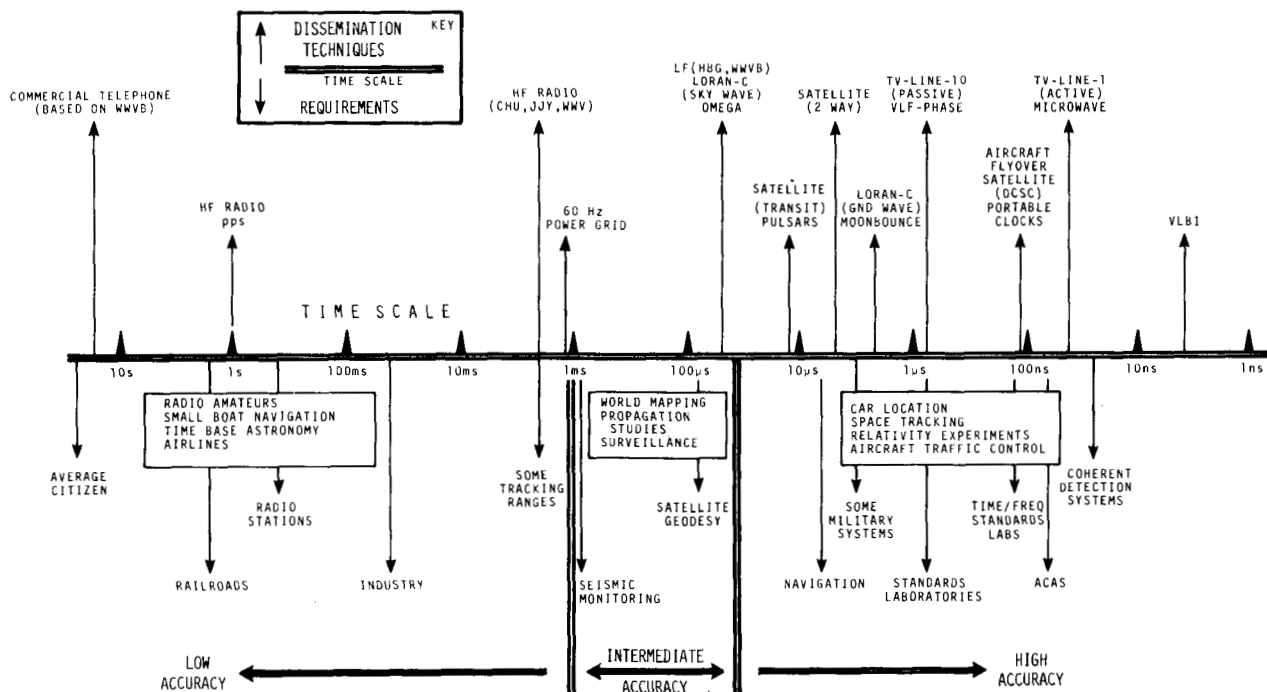

FIGURE 10.64. Time-accuracy requirements and capabilities of some time dissemination techniques and services.

### 10.6.2. Evaluation of T/F Systems

Figure 10.65 compares some TFD techniques. Such an evaluation is subjective, and some classifications are borderline. It is an attempt though, to show a realistic picture of present or proposed dissemination systems in terms of their capabilities and potentials. Accuracy figures are documented by applicable references. The ratings of good, fair, and poor are both arbitrary and broad. In the context of this presentation they are given for purposes of comparison and evaluation. Further explanatory comments concerning the scope and intent of the various characteristics identified in figure 10.65 follow:

(1) *Accuracy of date transfer.* Refers to that accuracy (degree of conformity with some specified value) to which time of day can be established at a given location. The numbers given are believed to be realistic for most users; it must be recognized that these numbers must be adjusted for either extremely favorable or unfavorable conditions, locations, etc. The ratings of good, fair, and poor are referenced to the needs of high, medium, and low accuracy users as shown in figure 10.64.

(2) *Accuracy of frequency synchronization.* Refers to that accuracy to which frequency standards can be synchronized within some frame of reference.

As with date transfer the three basic ratings are in terms of the classes of accuracy users shown in figure 10.64.

(3) *Ambiguity.* Applies to that interval of time which a given system or technique can provide with certainty. In some cases two values are shown, one is the basic period of a given carrier frequency, sequence, or audible tone; the other, by means of time code provides date information for periods up to a year. For instance, the period of a TV frame, 33 ms, is the ambiguity of the TV line-10 technique. The line-1 TV system, using the coded data displays, has 24-hour ambiguity.

(4) *Coverage.* Refers to the geographical region in which the dissemination technique can be used to obtain the stated accuracy. In many cases special considerations such as ground wave versus sky wave, propagation over land or water, availability of TV line networks, etc., may affect the coverage of a specific signal.

(5) *Percent of time available.* Describes the operating time of a service, i.e., continuous (good), a certain portion of a day (usually specified fair), or only occasionally, irregularly or by special arrangement (poor). Interruptions caused by propagation conditions such as sudden ionospheric disturbances, VLF diurnal phase shifts, or HF ionospheric disturbances are not considered.

DISSEMINATION TECHNIQUES		ACCURACY/FREQUENCY SYNCHRONIZATION STATUS (1)	ACCURACY FOR DATE TRANSFER	AMBIGUITY (4)	COVERAGE FOR STATED ACCURACY	% OF TIME AVAILABLE	RELIABILITY	RECEIVER COST FOR STATED ACCURACY	COST PER CALIBRATION	NUMBER OF USERS THAT CAN BE SERVED	OPERATOR SKILL REQUIRED FOR STATED ACCURACY	REFERENCES
VLF RADIO	COMMUNICATION/SFB GBR, NBA, WWVL	O	$1 \cdot 10^{11}$	ENVELOPE 500 $\mu$ s	PHASE $\sim 50 \mu$ s	GLOBAL						30,31,50
	NAVIGATION SYSTEM OMEGA	O/P	$< 1 \cdot 10^{11}$	$\leq 10 \mu$ s	PROPOSED CODE 1 YR PHASE $\sim 100 \mu$ s	GLOBAL		MODERATE				TIME CODE 59,93,265
LF RADIO	STANDARD FREQ. BROADCAST (WWVB)	O	$1 \cdot 10^{11}$ (PHASE 24h) (3)	ENVELOPE $\sim 50 \mu$ s	1 YR	USA (WWVB) LIMITED		MODERATE			USA (WWVB) EUROPE OTHERS	65,67
	NAVIGATION SYSTEM LORAN-C	O	$1 \cdot 10^{12}$	$\sim 1 \mu$ s (GND) 50 $\mu$ s (SKY)	50ms PHASE $\sim 10 \mu$ s	SPECIAL AREAS					SPECIAL AREAS	35,103
HF/MF RADIO	STANDARD FREQ. BROADCASTS (WWV)	O	$1 \cdot 10^{10}$	1000 $\mu$ s	1 DAY 0.5 min	HEMISPHERE		DEPENDS ON CONDITIONS				84,266
	NAVIGATION SYSTEM LORAN-A	O	$5 \cdot 10^{10}$	2.5 $\mu$ s NOT UTC		LIMITED AREAS		DEPENDS ON CONDITIONS			SPECIAL AREAS	2,100
TELEVISION (VHF/SHF RADIO)	PASSIVE LINE-10	O	$1 \cdot 10^{11}$ (24h)	$\sim 1 \mu$ s	1 DAY $\sim 33$ ms	NETWORK COVERAGE	"LIVE" PROGRAMS				USA FOR EXAMPLE	11,125,128
	ACTIVE LINE-1 (NBS TV TIME SYSTEM)	E	$1 \cdot 10^{11}$ (< 30 min)	$< 100$ ns	1 DAY $\sim 33$ ms	NETWORK COVERAGE					USA FOR EXAMPLE	124
SATELLITES (VHF/UHF/SHF RADIO)	STATIONARY SATELLITES (TRANSPONDER) ONE WAY	E/O	$1 \cdot 10^{10}$ (24h)	10-50 $\mu$ s	DEPENDS ON FORMAT	HEMISPHERE	STATIONARY					149,154,157
	STATIONARY SATELLITES (TRANSPONDER) TWO WAY	E/O	$1 \cdot 10^{12}$ (24h)	$\sim 100$ ns	DEPENDS ON FORMAT	HEMISPHERE			MODERATE			143,170
	ON BOARD CLOCK (ACTIVE) ONE WAY LOW ALTITUDE	O	$\sim 1 \cdot 10^{10}$ (24h)	0.5-50 $\mu$ s	DEPENDS ON FORMAT	WORLD	10-15 min PER PASS 2-4 PER DAY	CLOCK NEEDS ADJUSTMENT				140,146,160
SHF RADIO	MICROWAVE	E/O	$\sim 1 \cdot 10^{13}$ (PER WEEK)	$\leq 100$ ns	PHASE COMPARISON	LOCAL LINKS						169
	VLBI	P	$5 \cdot 10^{14}$	$\sim 1$ ns	DEPENDS ON FORMAT	HEMISPHERE	AS NEEDED					186,192
PORTABLE CLOCKS	PHYSICAL TRANSFER	O	$1 \cdot 10^{12}$	100ns	1 DAY	LIMITED BY TRANSPORTATION	AS NEEDED	NONE				235,238
	AIRCRAFT FLYOVER 2 WAY	E	$1 \cdot 10^{12}$	$\leq 100$ ns	DEPENDS ON FORMAT	LIMITED BY TRANSPORTATION	AS NEEDED					240,241
PULSARS	OPTICAL SIGNAL $\rightarrow$ NP 0532	P	$1 \cdot 10^{10}$	$\sim 10 \mu$ s	$\sim 33$ ms	HEMISPHERE	NIGHTTIME					253
AC POWER LINE	POWER NETWORK SYSTEM	P	$1 \cdot 10^8$	$\sim 100$ ns	16.7ms	CONTINENTAL USA		MINIMAL	MINIMAL	CONTINENTAL USA		264

GOOD  FAIR  POOR

NOTES: (1) Status of technique indicated as follows: O—Operational; P—Proposed; E/O—Experimental operational. (2) Estimates of day-to-day measurements within 2000 km (1250 mi) of Loran-A stations. These emissions not coordinated with UTC and manually operated crystal clocks drift. (3) From day-to-day phase measurements e.g., 1  $\mu$ s per day phase change approximates 1 pt. in  $10^{11}$  in frequency difference. (4) Left-hand designation gives the shortest time interval that cannot be resolved; Right-hand number gives basic ambiguity. ♦, by ground wave 1600 km; by sky wave thousands of kilometers depending upon conditions. ■, with proposed time code. ●, closure after 1 day. ▲, within local service area of TV transmitter and path delay known.

FIGURE 10.65. Evaluation of selected time/frequency dissemination techniques.

(6) *Reliability.* Estimates the degree of confidence in the operation of a system; considers such factors as propagation conditions, system components in satellite environment, rerouting of TV network programs, etc.

(7) *Receiver cost for stated accuracy.* Refers to the relative cost of an appropriate receiver and antenna system for obtaining the stated accuracy of a given technique. Equipment such as oscilloscopes, digital counters, etc., is not included. A poor rating implies a cost greater than several thousand dollars; fair refers to a cost in the \$1,000 to \$2,000 range; and good indicates a cost less than \$1,000.

(8) *Cost per calibration.* Considers factors such as the cost of required instrumentation to make the calibration and the probable frequency of calibration.

(9) *Number of users that can be served.* Refers to the probable number of users for a given dissemination technique assuming regular availability of the service, and considering the equipment costs involved. For example, the TV technique is considered to have more potential users than the WWVB broadcasts, even though both cover the continental U.S. Relevant factors also include the low cost of TV receivers and random propagation disturbances associated with WWVB reception.

(10) *Operation skill required for stated accuracy.* Describes the degree of difficulty in making a time/frequency measurement to the stated accuracy. A good rating is shown if the time information can be obtained simply from an oscilloscope display or a counter reading. A fair category indicates that the user must process the data to obtain the required information, make multiple measurements or select particular cycles of a radio signal, and/or use specialized receiving techniques. A poor rating indicates that complex procedures and special skills are required for a given technique. The use of the Omega system for determining time, for example, requires envelope recognition followed by cycle identification.

The following connotations are used in figure 10.65 in connection with the satellite techniques: A transponder satellite relays time signals from a ground reference station to users in either a *one-way* or *two-way* mode. In this evaluation *active* describes a satellite with an onboard clock. A *stationary* satellite is earth-synchronous or geostationary while an *orbiting* satellite is one with a period of revolution other than 24 hours.

It must be emphasized that the ratings are relative and arbitrary. Indeed, a system with a poor rating may be the best choice for many users. A severe limitation on the usefulness of figure 10.65 is that it reflects judgments of all parameters of a given system assuming that a user desires the highest accuracy normally available from the system. In the case of Loran-C, for example, use of a sky wave is excluded, with the result that *coverage* is rated poor.

A system designer will probably be forced to make compromises in choosing a dissemination service. He may have to trade *receiver cost* for *reliability*, or accept a *low percent of time available* for high *accuracy* and good *coverage*. Note that most techniques that rate "good" in accuracy are shown as fair or poor in other important categories. No one technique shows all favorable ratings, but HF broadcasts, stationary satellite relays (passive), and the proposed NBS TV Time System stand out with only one poor rating each. At present there is no implemented time dissemination system that permits comparison of a user's clock to a primary standard anywhere in the world at will and to an accuracy level that fully exploits the capability of atomic standards. Satellites appear to be capable of meeting such a challenge but worldwide satellite time dissemination service has not yet been implemented.

## 10.7. CONCLUSIONS

We have attempted to present a snapshot of proposed, experimental and operational systems for bridging the dissemination gap between a fre-

quency standard and a remote user. Many options are available to a time frequency user; choices must be based on evaluations of overall objectives, economics, advantages, and limitations for a particular situation. The picture is one of contrasts and variations in techniques, user requirements and accuracies, coupled with a multiplicity of inherent characteristics. In detail we see the time and frequency technology touching many diverse and increasingly important areas of human life; e.g. public safety, national defense, electric power utilities, integrated computing networks, broadcasting/television activities, transportation including aircraft-collision avoidance, telecommunication systems, etc. Basic science is influenced also in terms of a unified standard, international time scales, time/frequency calibrations, and time bases for monitoring natural events of nature. In summary, many time and frequency needs are now being met at various accuracy levels and in a variety of ways; on the other hand, some needs are unfulfilled because of accuracy requirements, economic factors, location of receivers, etc. We would emphasize the capability of present day communication and navigation systems (which of themselves require high timing accuracy) for providing time and frequency dissemination at small additional cost and ultimately at great savings to the frequency spectrum. Operationally, it is apparent that the capability for keeping accurate time has outstripped the capabilities for widespread and economic dissemination for the last several decades. Nevertheless, proposed and experimental systems show great promise. If one integrates and optimizes the TFD possibilities in today's picture and projects these elements into the future, an achievable challenge is seen; one can foresee the dissemination gap effectively eliminated with user equivalence of on-site standards-comparison at high accuracy, nearly global coverage and with reasonable-cost equipment.

## ACKNOWLEDGEMENTS

As an overview chapter, this presentation relies extensively upon published material as referenced; we are indebted, thus, to the research efforts of many individuals. We wish to thank R. Beehler, J. Barnes, J. Stanley, W. Hanson, A. Risley, and W. Hamilton of the National Bureau of Standards, Boulder, Colorado; and W. Klempner and D. Hilliard of the National Oceanic and Atmospheric Administration, Boulder, Colorado, for their contributions in reviewing and discussing portions of this paper. In addition, we thank G. Hufford, Anita Longley, G. Haydon, G. Gierhart, and B. Wieder of the Office of Telecommunications staff (ITS) at Boulder for detailed review and comments on Annex 10.A. The help of Sharon Erickson is greatly appreciated in the typing and preparation of this Chapter.

## 10.8. REFERENCES

- [1] Bagley, A., "Frequency and time measurements," *Handbuch der Physik* (Encyclopedia of Physics), A. E. Panenborg (Ed.), **23** (*Electrical Instruments*), pp. 289-372 (Springer-Verlag Publishing Co., Berlin, Germany, 1966).
- [2] Sperry Staff, "Study of methods for synchronizing remotely-located clocks," *Sperry Gyroscope Co. Rep. NASA CR-738*, 206 pages (NTIS, N67-19896, March 1967).
- [3] Begley, W. W., and Shapiro, A. H., "Aspects of precision timing systems," *Aerospace Corp. Rep. TOR-0066(5306)-2*, 115 pages (NTIS, AD 695458, October 1969).
- [4] Hewlett Packard Staff, "Frequency and time standards," *Appl. Note 52*, 91 pages (Hewlett-Packard, Palo Alto, CA 94304, November 1965); "Fundamentals of time and frequency standards," *Appl. Note 52-1* (Hewlett Packard, Palo Alto, CA 94304—in press).
- [5] Ward, F. A. B., *Time Measurement*, Pt. 1—Historical Review, 60 pages (H.M.S.O., William Clowes and Sons Ltd., London, England, 1961).
- [6] Smith, H. M., "International time and frequency coordination," *Proc. IEEE*, **60**, No. 5, pp. 479-487 (May 1972).
- [7] Willenar, A., Private communication (American Electric Power Co., Canton, OH 44720, January 18, 1973).
- [8] Halford, D., Hellwig, H., and Wells, J. S., "Progress and feasibility for a unified standard for frequency, time and length," *Proc. IEEE*, **60**, No. 6, pp. 623-625 (May 1972).
- [9] Dellinger, J. H., and Hall, E. L., "Radio dissemination of the national standard of frequency," *Radio Eng.*, **12**, No. 5, pp. 23-24 (May 1932).
- [10] Hellweg, J. F., "Time determination and time broadcast," *J. Franklin Inst.*, **223**, No. 5, pp. 549-563 (May 1937).
- [11] Selected references on theory of VLF propagation:
  - a. Wait, J. R., "Introduction to the theory of VLF propagation," *Proc. IRE*, **50**, No. 7, pp. 1624-1647 (July 1962).
  - b. Wait, J. R., "Recent theoretical advances in the terrestrial propagation of VLF electromagnetic waves," *Advan. Electron. and Electron. Physics*, L. Marton (Ed.), **25**, pp. 145-209 (Academic Press, Inc., New York, NY 10003, 1968).
  - c. Budden, K. G., *The Waveguide Mode Theory of Wave Propagation*, 325 pages (Prentice-Hall Publishing Co., Englewood Cliffs, NJ 07632, 1961).
- [12] Selected references on VLF propagation:
  - a. Crombie, D. D., "Further observations of sunrise and sunset fading of very-low frequency signals," *Radio Science*, **1**, (New Series), No. 1, pp. 47-51 (January 1966).
  - b. Crombie, D. D., "The waveguide mode propagation of VLF radio waves to great distances" (A Survey), *Proc. Conf. on MF, LF and VLF Radio Propagation*, W. T. Blackband, Chairman (London, England, November 8-10, 1967), *Inst. Elec. Eng. (London) Conf. Publ. No. 36*, pp. 138-158 (Savoy Place, London, England, 1967).
  - c. Wait, J. R., and Spies, K. P., "Characteristics of the earth-ionosphere waveguide for VLF radio waves," *Nat. Bur. Stand. (U.S.) Tech. Note 300*, 94 pages (USGPO, 1964); 1st Suppl., 24 pages (February 1965); 2nd Suppl., 14 pages (March 1965).
  - d. Reder, F. H., Abom, C. J., and Winkler, G. M. R., "Precise phase and amplitude measurements on VLF signals propagated through the arctic zone," *J. Res. Nat. Bur. Stand. (U.S.)*, **68D** (*Radio Sci.*), No. 3, pp. 275-281 (March 1968).
- [13] Johler, J. R., "Theory of propagation of low frequency terrestrial radio waves—mathematical interpretation of D-region propagation studies," *ESSA Tech. Rep. IER48-ITSA-47*, 47 pages (USGPO, August 1967).
- [14] Davies, K., *Ionospheric Radio Waves*, 460 pages (Blaisdell Publishing Co., Waltham, MA 02154, 1969).
- [15] Thompson, M. C., Jr., Vogler, L. E., Janes, H. B., and Wood, L. E., "A review of propagation factors in the telecommunications applications of the 10 to 100 GHz radio spectrum," *OT Eng. Rep. 34*, 76 pages (USGPO, August 1972).
- [16] Jespersen, J. L., Blair, B. E., and Gatterer, L. E., "Characterization and concepts of time-frequency dissemination," *Proc. IEEE*, **60**, No. 5, pp. 502-521 (May 1972).
- [17] Carter, P. S., and Beverage, H. H., "Early history of the antennas and propagation field until the end of World War I, Part 1—Antennas," *Proc. IRE*, **50**, No. 5, pp. 679-682 (May 1962).
- [18] Watt, A. D., *VLF Radio Engineering*, 701 pages (Pergamon Press, Inc., Oxford, England, 1967).
- [19] Austin, L. W., "Some quantitative experiments in long-distance radio telegraphy," *Nat. Bur. Stand. (U.S.) J. Res.*, **7**, No. 3, pp. 315-366 (October 1911).
- [20] Pierce, J. A., "Radux," *Cruft Lab Tech. Rep. No. 17* (Harvard Univ., Cambridge, MA 02138, July 1947).
- [21] Casselman, C. J., Heritage, D. P., and Tibbals, M. L., "VLF propagation measurements for the Radux-Omega navigation system," *Proc. IRE*, **47**, No. 5, pp. 829-839 (May 1959).
- [22] Pierce, J. A., Mitchell, H. T., and Essen, L., "World-wide frequency and time comparisons by means of radio transmissions," *Nature (Lett.)*, **174**, No. 4437, p. 922 (November 13, 1954).
- [23] Pierce, J. A., "Intercontinental frequency comparisons by very low frequency radio transmission," *Proc. IRE*, **45**, No. 6, pp. 794-803 (June 1957).
- [24] Crombie, D. D., Allan, A. H., and Newman, M., "Phase variations of 16 kc/s transmissions from Rugby as received in New Zealand," *Proc. Inst. Elec. Eng. (London)*, **105**, Part B, No. 21, pp. 301-304 (May 1958).
- [25] Pierce, J. A., Winkler, G. M. R., and Corke, R. L., "The 'GBR experiment': a transatlantic frequency comparison between cesium-controlled oscillators," *Nature*, **187**, No. 4741, pp. 914-916 (September 10, 1960).
- [26] Watt, A. D., and Plush, R. W., "Power requirements and choice of an optimum frequency for a worldwide standard frequency broadcasting station," *Nat. Bur. Stand. (U.S.) J. Res. (Radio Prop.)*, **63D**, No. 1, pp. 35-44 (July-August 1959).
- [27] Watt, A. D., Plush, R. W., Brown, W. W., and Morgan, A. H., "Worldwide VLF standard frequency and time signal broadcasting," *Nat. Bur. Stand. (U.S.) J. Res. (Radio Prop.)*, **65D**, No. 6, pp. 617-627 (December 1961).
- [28] Essen, L., and Steele, J. McA., "The international comparison of atomic standards of time and frequency," *Proc. Inst. Elec. Eng. (London)*, **109**, Part B, (Electron. and Commun. Eng.) Paper No. 3752M, pp. 41-47 (January 1962).
- [29] Mitchell, A. M. J., "Frequency comparison of atomic standards by radio signal," *Nature*, **198**, No. 4886, pp. 1155-1158 (June 1963).
- [30] Blair, B. E., Crow, E. L., and Morgan, A. H., "Five years of VLF worldwide comparison of atomic frequency standards," *Radio Science*, **2**, (New Series), No. 6, pp. 627-636 (June 1967).
- [31] Becker, G., Fischer, B., and Kramer, G., "Methoden und Ergebnisse im Internationalen Zeitvergleich mit Langswellen" (Methods and results of international VLF-time comparisons) *Proc. Colloque International de Chronometrie* (Intern. Horological symp., Paris, France, September 16-20, 1969). Paper A22, 24 pages (Nouvelle Faculte des Sciences, 11, Quai St., Paris (5), France, 1969).
- [32] Loutfy el Sayed, A., "Frequency standard work in Egypt," *Proc. IEEE (Lett.)*, **60**, No. 5, pp. 627-628 (May 1972).
- [33] Blackband, W. T., "Diurnal changes in the time of propagation of VLF waves over single mode paths," *Propagation of Radio Waves at Frequencies Below 300 kc/s* (Proc. 7th Meet. of the AGARD Ionos. Res. Comm., Munich, Germany, 1962), W. T. Blackband (Ed.), Chap. 16, pp. 219-229 (Pergamon Press, Ltd., Oxford, England, 1964).
- [34] Westfall, W. D., "Diurnal changes of phase and group velocity of VLF radio waves," *Radio Science*, **2** (New Series), No. 1, pp. 119-125 (January 1967).



- [35] Morgan, A. H., "Distribution of standard frequency and time signals," *Proc. IEEE*, **55**, No. 6, pp. 827-836 (June 1967).
- [36] Reder, F. H., "VLF phase tracking for PTTI application," *Proc. 3rd Ann. DOD Precise Time and Time Interval (PTTI) Strat. Plan. Meet.* (USNO, Washington, DC 20390; November 16-18, 1971), pp. 117-147 (USNO, Washington, DC 20390, 1972) (NTIS, AD 758739).
- [37] Looney, C. H., "A very-low frequency (VLF) synchronizing system," *Proc. IRE*, **49**, No. 2, pp. 448-452 (February 1961).
- [38] Morgan, A. H., Crow, E. L., and Blair, B. E., "International comparison of atomic frequency standards via VLF radio signals," *J. Res. Nat. Bur. Stand. (U.S.)*, **69D** (Radio Sci.) No. 7, pp. 905-914 (July 1965).
- [39] Echols, J. D., "Calibrating frequency standards with VLF transmissions," *Electronics*, **35**, No. 17, pp. 60-63 (April 1962).
- [40] Alpert, A., and Murphy, D., "Establishing, synchronizing, and maintaining a standard clock for the USAF calibration program," *Frequency*, **6**, No. 5, pp. 17-21 (May 1968).
- [41] Feistel, C. H., "Calibrating frequency standards with VLF/LF signals," *On Frequency*, **1**, No. 2, pp. 2-7 (Tracor, Austin, TX 78721, March 1969).
- [42] Viezbicke, P. P., (Ed.), "Time and frequency services bulletin," (Distributed upon request on basis of need) (National Bureau of Standards, Boulder, CO 80302, published monthly).
- [43] USNO, "Daily relative phase values," *Time Service Announcement Series 4* (issued weekly and distributed on basis of need); *Time Service Lett.* (Supplement No. 5 to daily phase values, Series 4): "Instructions to interpret the 'phase values' bulletin and teletype messages," 7 pages (USNO, Washington, DC 20390, September 30, 1968).
- [44] FOA, "Phase of standard frequency transmissions as received in Stockholm," (Research Institute of Swedish National Defense, Stockholm, Sweden—published monthly).
- [45] Fey, R. L., and Looney, C. H., Jr., "A dual frequency VLF timing system," *IEEE Trans. on Instrum. and Meas.*, **IM-15**, No. 4, pp. 190-195 (December 1966).
- [46] Baltzer, O. J., "Microsecond timekeeping by means of multiple frequency VLF reception," *Electron. Instrum. Digest (EID)*, (PMA Section) **6**, No. 12, pp. 75-79 (December 1970).
- [47] Hamilton, W. F., and Jespersen, J. L., "Application of VLF theory to time dissemination," *Nat. Bur. Stand. (U.S.) Tech. Note* **610**, 170 pages (USGPO, November 1971).
- [48] Fuzie, R. E., "DSIF network maintenance facility: reference standards frequency and timing laboratory," *Jet. Propulsion Lab. Space Programs Sum.* 37-63, **II**, pp. 101-107 (JPL, California Inst. of Technol., Pasadena, CA 91103, May 1970).
- [49] Wright, J. R., "Multiple frequency VLF timing," *On Frequency*, **1**, No. 3, pp. 2-6 (Tracor, Austin, TX 78721, May 1969).
- [50] Stone, R. R., Jr., Markowitz, W., and Hall, R. G., "Time and frequency synchronization of Navy VLF transmissions," *IRE Trans. on Instrum.*, **I-9**, No. 2, pp. 155-161 (September 1960).
- [51] Allan, D. W., and Barnes, J. A., "Some statistical properties of LF and VLF propagation," *Phase and Frequency Instability in Electromagnetic Propagation* (AGARD/EWP XIII Symp., Ankara, Turkey, October 9-12, 1967) *AGARD Conf. Proc. No. 33*, K. Davies (Ed.), Chap. 15, pp. 219-230 (Technivision Services, Slough, England, 1970).
- [52] Guétrot, A., Higbie, L. S., Lavanceau, J., and Allan, D. W., "An application of statistical smoothing techniques on VLF signals for comparison of time between USNO and NBS" (Summary), *Proc. 23rd Ann. Symp. on Frequency Control* (U.S. Army Electronics Command, Ft. Monmouth, NJ 07703, May 6-8, 1969), p. 248 (NTIS, AD 746209, 1969).
- [53] Stone, R. R., Jr., Gattis, T. H., Petit, R. C., and Liberman, T. N., "Time control of frequency shift keyed transmissions at VLF," *Proc. 25th Ann. Symp. on Frequency Control* (U.S. Army Electronics Command, Ft. Monmouth, NJ 07703, April 26-28, 1971), pp. 152-158 (NTIS, AD 746211, 1971).
- [54] Blair, B. E., and Morgan, A. H., "Control of WWV and WWVH standard frequency broadcasts by VLF and LF signals," *J. Res. Nat. Bur. Stand. (U.S.)*, **69D** (Radio Sci.), No. 7, pp. 915-928 (July 1965).
- [55] Stanbrough, J. H., Jr., "A VLF radio relative navigation system," *Navigation: J. Inst. Nav.*, **11**, No. 4, pp. 417-428 (January 1965).
- [56] Chilton, C. J., Crombie, D. D., and Jean, A. G., "Phase variations in VLF propagation," *Propagation of Radio Waves at Frequencies below 300 kc/s* (Proc. 7th Meet. of the AGARD Ionos. Res. Commun., Munich, Germany, 1962), W. T. Blackband (Ed.), Chap. 19, pp. 257-290 (Pergamon Press, Ltd., Oxford, England, 1964).
- [57] Iijima, S., Torao, M., and Fujiwara, K., "Phase variations of VLF waves, GBR, and GBZ as received," *Annals of Tokyo Astron. Observ.*, 2nd Series **11**, No. 1, 28 pages (1968).
- [58] Reder, F. H., "VLF propagation phenomena observed during low and high solar activity," *Progress in Radio Science-1966-1969* (Proc. XVth Gen. Assem. of URSI, Ottawa, Canada, August 18-28, 1969), J. A. Lane et al. (Eds.), **2**, pp. 113-140 (URSI, Brussels, Belgium, 1971).
- [59] Swanson, E. R., and Kugel, C. P., "VLF timing: conventional and modern techniques including Omega," *Proc. IEEE*, **60**, No. 5, pp. 540-551 (May 1972).
- [60] Pierce, J. A., "The use of composite signals at very low radio frequencies," *Harvard Tech. Rept. No. 522*, 31 pages (NTIS, AD 666567, February 1968).
- [61] Essen, L., "Standard frequency transmissions," *Proc. Inst. Elec. Eng. (London)*, **101**, No. 72, Pt. III (Paper No. 1677), pp. 249-255 (July 1954).
- [62] George, W. D., "Low frequency standard transmission," *Proc. 11th Ann. Symp. on Frequency Control* (Signal Corps Eng. Lab., Ft. Monmouth, NJ 07703, May 7-9, 1957), pp. 574-585 (NTIS, AD 298 323, 1957).
- [63] Pierce, J. A., "Recent long-distance frequency comparisons," *IRE Trans. on Instrum.*, **I-7**, Nos. 3 and 4, pp. 207-210 (December 1958).
- [64] Viezbicke, P. P. (Ed.), "NBS frequency and time broadcast services," *Nat. Bur. Stand. (U.S.) Spec. Publ. 236*, 1973 Edition, 19 pages (USGPO, May 1973).
- [65] Hartke, D., "Simplified local comparisons with USFS," *Frequency*, **2**, No. 2, pp. 32-33 (March-April 1964).
- [66] Manly, E. P., "WWVB 60 kHz frequency comparator receiver," *73 Magazine*, No. 144, pp. 16-18, 20, 22-24, 26 (September 1972).
- [67] Andrews, D., Chaslain, C., and DePrins, J., "Reception of low frequency time signals," *Frequency*, **6**, No. 9, pp. 13-21 (September 1968).
- [68] LaVeau, B. J., "A new time standard," *Leeds and Northrup Tech. J.*, Issue 7, pp. 10-15 (Fall 1969).
- [69] Cohn, N., "Power systems time and frequency," *Leeds and Northrup Tech. J.*, Issue 7, pp. 3-9 (Fall 1969).
- [70] Eaton, J. P., O'Neill, M. E., and Murdock, J. N., "After-shocks of the 1966 Parkfield-Cholame California earthquake: a detailed study," *Bull. Seismol. Soc. Amer.*, **60**, No. 4, pp. 1151-1197 (August 1970).
- [71] Mereu, R. F., and Kovach, R. J., "A portable inexpensive seismic system for crustal studies," *Bull. Seismol. Soc. Amer.*, **60**, No. 5, pp. 1607-1613 (October 1970).
- [72] Luichinger, M. J., "More about time and the telephone company," *Telephony*, **174**, No. 20, pp. 33, 36, 38, 40, 72, 74, and 76 (May 18, 1969).
- [73] CCIR, "Standard frequency and time signals," (Study Group 7), *XIIIth Plenary Assembly* (New Delhi, India, 1970), **III**, pp. 229-240 (ITU, Geneva, Switzerland, 1970).
- [74] USNO, "Worldwide primary VLF and HF transmissions," *Time Service Announcement, Ser. 1*, No. 2, 10 pages (USNO, Washington, DC 20390, June 15, 1972).
- [75] van Groos, J. C., "Time and frequency standards," *Measurements and Data*, **3**, No. 1, page 92 (January-February 1969).
- [76] Stanley, J., Private communication (January 26, 1973).

- [77] Beers, Y., "WWV moves to Colorado," Parts I and II, *QST*, **LI**, No. 1, pp. 11-14 (January 1967); **LI**, No. 2, pp. 30-36 (February 1967).
- [78] Viezbicke, P. P., "NBS frequency-time broadcast station WWV, Fort Collins, Colorado," *Nat. Bur. Stand. (U.S.) Tech. Note 611*, 29 pages (USGPO, October 1971).
- [79] Milton, J. B., "Standard time and frequency: its generation, control, and dissemination from the National Bureau of Standards Time and Frequency Division," *Nat. Bur. Stand. (U.S.) Tech. Note 379*, 27 pages (USGPO, August 1969) (or future updates).
- [80] Systron Donner Appl. Eng. Staff, *Handbook of Precision Timekeeping and Tape Search*, 138 pages (Systron Donner Corp., Concord, CA 84520, January 1970).
- [81] Stanley, J., "Use and limitation of standard broadcast for time and frequency comparison," *Proc. 4th Ann. NASA and DOD Precise Time and Time Interval (PTTI) Plan. Meet.* (NASA Goddard Space Flight Center, Greenbelt, MD 20771, November 14-16, 1972), pp. 249-258 (NASA, X-814-73-72, Greenbelt, MD 20771, 1973).
- [82] Angelotti, E., and Leschiutta, S., "A new determination of HF time measurements accuracy," IEN Report, 7 pages (Torino, Italy, 1968).
- [83] Winkler, G. M. R., "Concept and advantages for PTTI integration of time ordered systems," *Proc. 2nd Ann. Precise Time and Time Interval (PTTI) Strat. Plan. Meet.* (USNO, Washington, DC 20390, December 10-11, 1970), **I**, pp. 156-168 (NTIS, AD 881 014L, 1971).
- [84] Morgan, A. H., "Precise time synchronization of widely separated clocks," *Nat. Bur. Stand. (U.S.) Tech. Note 22*, 65 pages (NTIS, PB 151 381, July 1959).
- [85] Barghausen, A. F., Finney, J. W., Proctor, L. L., and Schultz, L. D., "Predicting long-term operational parameters and high-frequency sky-wave telecommunications systems," *ESSA Tech. Rep. ERL 110-ITS 78*, 290 pages (USGPO, May 1969).
- [86] Swanson E. R., "Time dissemination effects caused by instabilities of the medium," *Phase and Frequency Instabilities in Electromagnetic Wave Propagation* (Ankara, Turkey, October 9-12, 1967) *AGARD Conf. Proc. No. 33*, K. Davies (Ed.), Chap 13, pp. 180-197 (Technivision Services, Slough, England, July 1970).
- [87] Piece, J. A., "Omega," *IEEE Trans. on Aerospace Electron. Syst.*, **AES-1**, No. 3, pp. 206-215 (December 1965).
- [88] Pierce, J. A., Palmer, W., Watt, A. D., and Woodward, R. H., *Omega—a worldwide navigational system*, 2d Edition, 270 pages (NTIS, AD 630 900, May 1966).
- [89] Kirby, R. A., "Evaluation of Omega navigation system," *Geophysics*, **35**, No. 2, pp. 344-356 (April 1970).
- [90] Kugel, C. P., "Omega system synchronization," *NELC Rep. 1529*, 24 pages (Naval Electronics Laboratory Center, San Diego, CA 92152, January 1968).
- [91] Burgess, B., and Walker, D., "Effects in Omega from propagation variations," *J. Inst. Nav.* (London), **23**, No. 1, pp. 49-59 (January 1970).
- [92] Wilson, J. J., Britt, J. E., and Chi, A. R., "Omega timing receiver, design, and system test," *Proc. 4th Ann. NASA and DOD Precise Time and Time Interval (PTTI) Plan. Meet.* (NASA, Goddard Space Flight Center, Greenbelt, MD 20771, November 14-16, 1972), pp. 345-361 (NASA, X-814-73-72, Greenbelt, MD 20771, 1973).
- [93] Fey, L., "A time code for the Omega worldwide navigation system," *Proc. IEEE (Lett.)*, **60**, No. 5, p. 630 (May 1972).
- [94] Doherty, R. H., Hefley, G., and Linfield, R. F., "Timing potentials of Loran-C," *Proc. IRE*, **49**, No. 11, pp. 1659-1673 (November 1961).
- [95] Hefley, G., "The development of Loran-C navigation and timing," *Nat. Bur. Stand. (U.S.) Monogr. 129*, 157 pages (USGPO, October 1972).
- [96] Shapiro, L. D., "Time synchronization from Loran-C," *IEEE Spectrum*, **5**, No. 8, pp. 46-55 (August 1968).
- [97] Pakos, P. E., "Use of the Loran-C system for time and frequency dissemination," *Frequency Technology*, **7**, No. 7, pp. 13-18 (July 1969).
- [98] Stetina, F. L., and Zufall, S. Z., "Loran-C—A time synchronization technique," *Goddard Space Flight Center Tech. Rept. X-832-69-514*, 87 pages (NASA, Goddard Space Flight Center, Greenbelt, MD 20771, September 1969).
- [99] USNO, "Time of coincidence (null) ephemeris for Loran-C chains," *Time Service Announcement Ser. 9* (USNO, Washington, DC 20390) (Published in advance and available upon basis of need.).
- [100] Johler, J. R., "Propagation of the low frequency radio signal," *Proc. IRE*, **50**, No. 4, pp. 404-427 (April 1962).
- [101] Johler, J. R., and Berry, L. A., "Loran-D phase corrections over inhomogeneous irregular terrain," *ESSA Tech. Rept. IER 59-ITS A 56*, 70 pages (USGPO, November 1967).
- [102] Wieder, B., "Use of Loran-C over land," *Proc. 25th Ann. Symp. on Frequency Control* (U.S. Army Electronics Command, Ft. Monmouth, NJ 07703, April 26-28, 1971), pp. 171-178 (NTIS, AD 746211, 1971).
- [103] Potts, C. E., and Wieder, B., "Precise time and frequency dissemination via the Loran-C system," *Proc. IEEE*, **60**, No. 5 pp. 530-539 (May 1972).
- [104] Shapiro, L. D., "Loran-C timing," *Frequency*, **3**, No. 2, pp. 32-37 (March-April 1965).
- [105] Stone, C. S., "Loran-C skywave timing experiment," *Austron Tech. Note 168-1*, 9 pages (Austron, Inc., Austin, TX 78753, 1968).
- [106] Doherty, R. H., "Experimental observations and theoretical calculations leading to a model of the lower ionosphere," *Proc. Intern. Conf. on the Ionosp.*, (Imperial College, London, England, July 2-6, 1962), pp. 428-434 (Inst. of Phys. and Phys. Soc., London, England, July 1963).
- [107] Mazur, W. E., Jr., "Operational considerations for the use of Loran-C skywaves for time synchronization," *Goddard Space Flight Center Tech. Rep. X-573-71-148*, 52 pages (NTIS, N71-24880, April 1971).
- [108] Pierce, J. A., McKensie, A. A., and Woodward, R. H., (Eds.), *Loran-Long Range Navigation*, 476 pages (McGraw-Hill Book Co. Inc., New York, NY 10020, 1948).
- [109] Beck, G. E., (Ed.), *Navigation Systems—A Survey of Modern Electronic Aids*, pp. 89-99 (Van Nostrand Reinhold Co., London, England, 1971).
- [110] Johler, J. R., "Loran-A ground wave pulse propagation," *OT/ITS Rep. RR 10*, 71 pages (USGPO, March 1971).
- [111] Tolman, J., Ptáček, V., Souček, A., and Stecher, R., "Microsecond clock comparison by means of TV synchronizing pulses," *IEEE Trans. on Instrum. and Meas.*, **IM-16**, No. 3, pp. 247-254 (September 1967).
- [112] Souček, A., "Travel time stability on TV relay links," *Radio Television* (Oirt Publication), No. 5, pp. 29-31 (Prague, Czechoslovakia, September 1969).
- [113] Allan, D. W., Leschiutta, S., and Rovera, G., "TV frame pulses used for precision time synchronization and their noise distribution," *Alta Frequenza*, **34** (English issue No. 2), p. 180E (March 1970).
- [114] Miller, M. J., "Synchronization of distant clocks by television pulse comparisons," *Astron. Soc. Australia*, **1**, No. 7, p. 352 (April 1970).
- [115] Pali, G. N., "Experimental evaluation of the error of joining time scales over wide-band communication and television channels," *Izmeritel'naya Tekhnika*, No. 5, pp. 28-31, May 1970; English translation—*Meas. Techniques*, **13**, No. 5, pp. 670-674 (Plenum Publishing Co., New York, NY 10011, May 1970).
- [116] Davis, D. D., Jespersen, J. L., and Kamas, G., "The use of television signals for time and frequency dissemination," *Proc. IEEE (Lett.)*, **58**, No. 6, pp. 931-933 (June 1970).
- [117] Parcelier, P., "Time synchronization by television," *IEEE Trans. on Instrum. and Meas.*, **IM-19**, No. 4, pp. 233-238 (November 1970).
- [118] Becker, G., and Enslin, H., "Genauere Zeit- und Frequenzverleiche mittels Fernseh-Bildimpulsen," (Exact time and frequency comparison via television sync pulses), *Frequenz*, **26**, No. 12, pp. 332-337 (December 1972) (in German).
- [119] Pali, G. N., Luk'yanchenko, Ya. I., Fedorov, Yu. A., and Vnukov, E. M., "Experimental high precision system for transmitting time units and frequency over television

- channels," *Izmeritel'naya Tekhnika*, No. 1, pp. 34-37, January 1972; English translation—*Meas. Techniques*, **15**, No. 1, pp. 54-59 (Plenum Publishing Co., New York, NY 10011, January 1972).
- [120] Leschiutta, S., "Long-term accuracy of time comparisons via TV signal along radio relay links," *IEEE Trans. on Instrum. and Meas.*, **IM-22**, No. 1, pp. 84-87 (March 1973).
- [121] Lavanceau, J. D., and Carroll, D., "Real time synchronization via passive television transmission," *Proc. 3rd Ann. Precise Time and Time Interval (PTTI) Strat. Plan. Meet.* (USNO, Washington, DC 20390, November 16-18, 1971), **1**, pp. 331-366 (USNO, Washington, DC 20390, 1972) (NTIS, AD 758739).
- [122] Davis, D. D., "Frequency standard hides in every color set," *Electronics*, **44**, No. 10, pp. 96-98 (May 10, 1971).
- [123] Howe, D. A., "Results of active line-1 TV timing," *Proc. IEEE (Lett.)*, **60**, No. 5, pp. 634-637 (May 1972).
- [124] Howe, D. A., "Nationwide precise time and frequency distribution utilizing an active code within network television broadcasts," *IEEE Trans. on Instrum. and Meas.*, **IM-21**, No. 3, pp. 263-276 (August 1972).
- [125] Davis, D. D., Blair, B. E., and Barnaba, J. F., "Long-term continental U.S. timing system via television networks," *IEEE Spectrum*, **8**, No. 8, pp. 41-52 (August 1971).
- [126] Berger, U. S., "TD-2: eighteen years and still growing," *Bell Lab Record*, **46**, No. 7, pp. 210-216 (July/August 1968).
- [127] Westman, H. P., (Ed.), *Reference Data for Radio Engineers*, 5th Ed., Sec. 28, pp. 29-34 (Howard W. Sams & Co., Indianapolis, IN 46268, 1969).
- [128] Allan, D. W., Blair, B. E., Davis, D. D., and Machlan, H. E., "Precision and accuracy of remote synchronization via network television broadcasts, Loran-C and portable clocks," *Metrologia*, **8**, No. 2, pp. 64-72 (April 1972).
- [129] Allan, D. W., "Statistics of atomic frequency standards," *Proc. IEEE*, **54**, No. 2, pp. 221-230 (February 1966) (see chap. 8).
- [130] Barnes, J. A., Chi, A. R., Cutler, L. S., Healey, D. J., Leeson, D. B., McGunigal, T. E., Mullen, J. A. Jr., Smith, W. L., Sydnor, R., Vessot, R. F. C., and Winkler, G. M. R., "Characterization of frequency stability," *IEEE Trans. on Instrum. and Meas.*, **IM-20**, No. 2, pp. 105-120 (May 1971) (see chap. 8).
- [131] Winkler, G. M. R., Hall, R. G., and Percival, D. B., "The U.S. Naval Observatory clock time reference and the performance of a sample of atomic clocks," *Metrologia*, **6**, No. 4, pp. 126-134 (October 1970).
- [132] Allan, D. W., and Gray, J. E., "Comments on the October 1970 Metrologia paper 'the U.S. Naval Observatory clock time reference and the performance of a sample of atomic clocks,'" *Metrologia*, **7**, No. 2, pp. 79-82 (April 1971).
- [133] Koide, F. K., and Vignone, E. J., "TV time synchronization in the western U.S.," *Electron. Instrum. Dig. (EID) (PMA Section)* **7**, No. 10, pp. 26-31 (October 1971).
- [134] Jaffee, L., "Communication by satellite," *Intern. Science and Tech.*, No. 8, pp. 44-51 (August 1962).
- [135] McKenzie, A. A., "What's up in satellites," *IEEE Spectrum*, **9**, No. 5, pp. 16-27 (May 1972).
- [136] Chistyakov, N. I., "Broadcasting by means of satellites," English translation of *Radioveshchaniye Cherez Sputniki* (Zvanize Press Moscow, 1972), 49 pages (NTIS, N 71-17466, February 1971).
- [137] Freiesleben, H. C., "The use of satellites for maritime purposes," *Eurospace Memoranda*, No. 8, 88 pages (NTIS, N72-16514, July 1971).
- [138] Keane, L., Brandel, D. L., Engles, P. D., and Waetjen, R. M., "Global navigation and traffic control using satellites," *NASA Tech. Rep. TRR-342*, 26 pages (NTIS, N70-33324, July 1970).
- [139] Osborne, E. F., "Global timing systems of nanosecond accuracy using satellite references," *Tech. Memo. TF-1086*, Johns Hopkins Univ., Appl. Phys. Lab., 182 pages (NTIS, AD 700 661, October 1969).
- [140] Easton, R., "The role of time/frequency in Navy navigation satellites," *Proc. IEEE*, **60**, No. 5, pp. 557-563 (May 1972).
- [141] Mazur, W. E., and Laios, S. C., "A compendium of satellite time-synchronization techniques," *NASA-GSFC Rep. X-573-69-394*, 13 pages (NASA, Goddard Space Flight Center, Greenbelt, MD 20771, August 1969).
- [142] Guier, W. H., and Weiffenbach, G. C., "A satellite Doppler navigation system," *Proc. IRE*, **48**, No. 5, pp. 507-516 (April 1960).
- [143] Jespersen, J. L., Kamas, G., Gatterer, L. E., and MacDoran, P. F., "Satellite VHF transponder time synchronization," *Proc. IEEE*, **56**, No. 7, pp. 1202-1206 (July 1968).
- [144] Autonetics Staff, "Analysis of an advanced time-frequency national air space system concept," **2**, *North American Rockwell Rep. No. RD-69-32-11*, 407 pages (NTIS, AD 695 436, August 1969).
- [145] Steele, J. McA., Markowitz, W., and Lidback, C. A., "Telstar time synchronization," *IEEE Trans. on Instrum. and Meas.*, **IM-13**, No. 4, pp. 164-170 (December 1964).
- [146] Laidet, L. M., "Worldwide synchronization using the TRANSIT satellite system," *Proc. IEEE (Lett.)*, **60**, No. 5, pp. 630-632 (May 1972).
- [147] RRL Freq. Std. Sect. and Kashima Branch, "Report on clock pulse synchronization experiment via RELAY II satellite," *J. Radio Res. Lab.*, **12**, No. 63, pp. 311-316 (September 1965).
- [148] Markowitz, W., Lidback, C. A., Uyeda, H., and Muramatsu, K., "Clock synchronization via RELAY II satellite," *IEEE Trans. on Instrum. and Meas.*, **IM-15**, No. 4, pp. 177-184 (December 1966).
- [149] Gatterer, L. E., Bottone, P. W., and Morgan, A. H., "Worldwide clock synchronization using a synchronous satellite," *IEEE Trans. on Instrum. and Meas.*, **IM-17**, No. 4, pp. 372-378 (December 1968).
- [150] Laios, S. C., "STADAN clock synchronization via GEOS-II satellite," *NASA-GSFC Rep. No. X-570-69-159*, 43 pages (NASA, Goddard Space Flight Center, Greenbelt, MD 20771, March 1969).
- [151] Laios, S. C., "Satellite time synchronization of a NASA network," *Proc. IEEE (Lett.)*, **60**, No. 5, pp. 632-633 (May 1972).
- [152] Murray, J. A., Jr., "Satellite communications system," *Proc. 2nd Ann. Precise Time and Time Interval (PTTI) Strat. Plan. Meet.*, (USNO, Washington, DC 20390, December 10-11, 1970), **1**, pp. 55-78 (NTIS, AD 881014-L, 1971).
- [153] Mazur, W. E., Jr., "Dual transponder time synchronization at C band using ATS-3," *Proc. IEEE (Lett.)*, **60**, No. 5, pp. 633-634 (May 1972).
- [154] Hanson, D. W., and Hamilton, W. F., "One-way time synchronization via geostationary satellites at UHF," *IEEE Trans. on Instrum. and Meas.*, **IM-20**, No. 3, pp. 147-153 (August 1971).
- [155] Hanson, D. W., and Hamilton, W. F., "Clock synchronization for satellite tracking," *IEEE Trans. on Aerospace and Electron. Sys.*, **AES-7**, No. 5, pp. 895-899 (September 1971).
- [156] Easton, R., "Timing receiver for timing satellite," *Proc. 3rd Ann. DOD Precise Time and Time Interval (PTTI) Strat. Plan. Meet.* (USNO, Washington, DC 20390, November 16-18, 1971), pp. 45-66 (USNO, Washington, DC 20390, 1972) (NTIS, AD 758739).
- [157] Hanson, D. W., and Hamilton, W. F., "Time and frequency broadcast experiments from the ATS-3 Satellite," *Nat. Bur. Stand. (U.S.), Tech. Note 645*, 115 pages (November 1973).
- [158] Kershner, R. B., and Newton, R. R., "The TRANSIT system," *J. Inst. Nav. (England)*, **15**, No. 2, pp. 129-144 (April 1962).
- [159] Stansell, T. A., Jr., "TRANSIT, the Navy navigation satellite system," *Navigation: J. Inst. Nav.*, **18**, No. 1, pp. 93-109 (Spring 1971).
- [160] Rueger, L. J., "TRANSIT navigation system," *Proc. 2nd Ann. Precise Time and Time Interval (PTTI) Strat. Plan. Meet.* (USNO, Washington, DC 20390, December 10-11, 1970), **1**, pp. 84-107 (NTIS, AD 881014-L, 1971).

- [161] Kershner, R. B., "The incremental phase shifter and PRM time transfer," *Proc. 3rd Ann. DOD Precise Time and Time Interval (PTTI) Strat. Plan. Meet.* (USNO, Washington, DC 20390, November, 16-18, 1971), pp. 23-42, (USNO, Washington, DC 20390, 1972) (NTIS, AD 758739).
- [162] Easton, R., "British American satellite time transfer experiments," *Proc. 4th Ann. NASA and DOD Precise Time and Time Interval (PTTI) Plan. Meet.* (NASA, Goddard Space Flight Center, Greenbelt, MD 20771, November 14-16, 1972), pp. 14-28 (NASA, X-814-73-72, Greenbelt, MD 20771, 1973).
- [163] Bartholow, C. A., "TIMATION III satellites," *Proc. 4th Ann. NASA and DOD Precise Time and Time Interval (PTTI) Plan. Meet.* (NASA, Goddard Space Flight Center, Greenbelt, MD 20771, November 14-16, 1972), pp. 7-13 (NASA, X-814-73-72, Greenbelt, MD 20771, 1973).
- [164] Enright, R. E., "DSCS PTTI transfer," *Proc. 3rd Ann. DOD Precise Time and Time Interval (PTTI) Strat. Plan. Meet.*, (USNO, Washington, DC 20390, November 16-18, 1971), pp. 167-180 (USNO, Washington, DC 20390, 1972) (NTIS, AD 758739).
- [165] Murray, J. A., Jr., "Mini modem for PTTI dissemination," *Proc. 3rd Ann. DOD Precise Time and Time Interval (PTTI) Strat. Plan. Meet.* (USNO, Washington, DC 20390, November 16-18, 1971), pp. 103-115 (USNO, Washington, DC 20390, 1972) (NTIS, AD 758739).
- [166] Schneider, R. J., "Time and frequency standardization," *Proc. 3rd Ann. DOD Precise Time and Time Interval (PTTI) Strat. Plan. Meet.* (USNO, Washington, DC 20390, November 16-18, 1971), pp. 7-21 (USNO, Washington, DC 20390, 1972) (NTIS, AD 758739).
- [167] Sivers, A. P., *Osnovy Kosmicheskoy Radioelektroniki (Principles of Space Radioelectronics)* "Satellite communication line networks and systems,"—English translation, Sec. 8 of Chap. IV, pp. 174-182 (Moscow, Izd-vo Sovetskoye Radio, Russia) (NTIS, N-211157, 1972).
- [168] Hamilton, W. F., and Hanson, D. W., "A synchronous satellite time delay computer," *Nat. Bur. Stand. (U.S.) Tech. Note 638*, 39 pages (USGPO, July 1973).
- [169] Phillips, D. H., Phillips, R. E., and O'Neill, J. J., "Time and frequency transfer via microwave link," *IEEE Trans. on Instrum. and Meas.*, **IM-20**, No. 1, pp. 23-28 (February 1971).
- [170] Murray, J. A., Pritt, D. L., Blocker, L. W., Leavitt, W. E., Hooten, P. M., and Goring, W. D., "Time transfer by Defense communication satellite," *Proc. 25th Ann. Symp. on Frequency Control* (U.S. Army Electronics Command, Ft. Monmouth NJ 07703, April 26-28, 1971), pp. 186-193 (NTIS, AD 746211, 1971).
- [171] Curtwright, J. B., "Precision time distribution within a deep space communications complex," *Proc. 4th Ann. NASA and DOD Precise Time and Time Interval (PTTI) Plan. Meet.* (NASA, Goddard Space Flight Center, Greenbelt, MD 20771, November 14-16, 1972), pp. 203-212 (NASA, X-814-73-72, Greenbelt, MD 20771, 1973).
- [172] Strock, M. S., "Standard frequency dissemination," *Proc. IRE*, **15**, No. 8, pp. 727-731 (August 1927).
- [173] Montgomery, L. H., "Frequency standardization of broadcast carriers," *CPEM Digest 1970—Conference on Precision Electromagnetic Measurements* (NBS/IEEE/URSI, Boulder, CO 80302, June 2-5, 1970) *IEEE Cat. No. 70C 20 PREC.*, p. 79 (1970).
- [174] Montgomery, L. H., "Standard frequency and time service using radio broadcasting facilities," *Proc. 26th Ann. Symp. on Frequency Control* (U.S. Army Electronics Command, Ft. Monmouth, NJ 07703, June 6-8, 1972), pp. 317-318 (Electron. Ind. Assn., Washington, DC 20006, 1972).
- [175] Montgomery, L. H., Private communication (January 24, 1973).
- [176] Latorre, V. R., "The phase stability of VHF signals reflected from meteor trails," *IEEE Trans. on Ant. and Prop.*, **AP-13**, No. 4, pp. 546-550 (July 1965).
- [177] Sanders, W. R., Albright, D. L., Tashiro, S., and March, D. N., "A meteor burst clock synchronization experiment," *IEEE Trans. on Instrum. and Meas.*, **IM-15**, No. 4, pp. 184-189 (December 1966).
- [178] Dudnik, B. S., Kashcheev, B. L., Leikin, A. Ya., Smirnov, A. N., and Sopol'nikov, M. D., "Use of meteoric reflection of radio waves to compare the clocks of time and frequency service stations," *Izmeritel'naya Tekhnika*, No. 12, pp. 38-42, December 1971; English translation—*Meas. Techniques*, **14**, No. 12, pp. 1842-1847 (Plenum Publ. Co., New York, NY 10011, December 1971).
- [179] Latorre, V. R., "Messages by Meteor," *Electronics*, **38**, No. 21, pp. 102-106 (October 18, 1965).
- [180] Sugar, G. R., "Radio propagation by reflection from meteor trails," *Proc. IEEE*, **52**, No. 2, pp. 116-136 (February 1964).
- [181] March, D. N., Tashiro, S., and Sanders, W. R., "Meteor trail forward scatter time synchronization system," *Frequency*, **6**, No. 2, pp. 12-17 (February 1968).
- [182] Latorre, V. R., and Johnson, G. L., "Time synchronization techniques," *1964 IEEE Intern. Conv. Record*, Pt. 6, pp. 422-427 (March 1964).
- [183] Broten, N. W., Legg, T. H., Locke, J. L., McLeish, C. W., Richards, R. S., Chisholm, R. M., Gush, H. P., Yen, J. L., and Galt, J. A., "Long baseline interferometry, a new technique," *Science*, **156**, No. 3782, pp. 1592-1593 (June 23, 1967).
- [184] Bare, C., Clark, B. G., Kellerman, K. I., Cohen, M. H., and Jauncey, D. L., "Interferometer experiment with independent local oscillators," *Science*, **157**, No. 3785, pp. 189-191 (July 14, 1967).
- [185] Burke, B. F., "Long-baseline interferometry," *Physics Today*, **22**, No. 7, pp. 54-63 (July 1969).
- [186] Klemperer, W. K., "Long-baseline radio interferometry with independent frequency standards," *Proc. IEEE*, **60**, No. 5, pp. 602-609 (May 1972).
- [187] Hinteregger, H. F., Shapiro, I. I., Robertson, D. S., Knight, C. A., Ergas, R. A., Whitney, A. R., Rogers, A. E. E., Moran, J. M., Clark, T. A., and Burke, B. F., "Precision geodesy via radio interferometry," *Science*, **178**, No. 4059, pp. 396-398 (October 27, 1972).
- [188] Shapiro, I. I., and Knight, C. A., "Geophysical applications of long-baseline radio interferometry," *Earthquake Displacement Fields and the Rotation of the Earth*, L. Mansinha et al. (Eds.), pp. 284-301 (D. Reidel Publ. Co., Dordrecht, Holland, 1970).
- [189] Gold, T., "Radio method for the precise measurement of the rotation period of the earth," *Science*, **157**, No. 3786, pp. 302-304 (July 21, 1967).
- [190] Rogers, A. E. E., and Moran, J. M., Jr., "Very long baseline interferometry as a means of worldwide time synchronization," *Lincoln Lab. Tech. Rep. 478*, 9 pages (NTIS, AD 704134, February 1970).
- [191] Broderick, J. J., Clark, B. G., Cohen, M. H., Ephanov, V. A., Hansson, B., Jauncey, D. L., Kellerman, K. I., Kogan, L. R., Kostenko, V. I., Matveyenko, L. I., Moiseyev, I. G., Payne, J., and Vitkevitch, V. V., "Interferometric observations on the Green Bank—Crimea baseline summary," *Radio Science*, **5**, No. 10, p. 1281 (October 1970).
- [192] Hurd, W. J., "An analysis and demonstration of clock synchronization by VLBI," *Proc. 4th Ann. NASA and DOD Precise Time and Time Interval (PTTI) Plan. Meet.* (NASA, Goddard Space Flight Center, Greenbelt, MD 20771, November 14-16, 1972) pp. 100-122 (NASA, X-814-73-72, Greenbelt, MD 20771, 1973).
- [193] Fanselow, J. L., MacDoran, P. F., Thomas, J. B., Williams, J. G., Finnie, C. J., Sato, T., Skjerve, L., and Spitzmesser, D. J., "The Goldstone interferometer for earth physics," *Jet Propulsion Lab. Tech. Rep. 32-1526*, **V**, pp. 45-57 (JPL, Calif. Inst. of Technol., Pasadena, CA 91103, October 1971).
- [194] Klemperer, W. K., Private communication (June 1971).
- [195] Mather, N. C., Grossi, M. D., and Pearlman, M. R., "Atmospheric effects in very long baseline interferometry," *Radio Science*, **5**, No. 10, pp. 1253-1261 (October 1970).
- [196] Rogers, A. E. E., "Very long baseline interferometry with large effective bandwidth for phase-delay measure-

- ments," *Radio Science*, **5**, No. 10, pp. 1239-1247 (October 1970).
- [197] Baumgartner, W. S., and Easterling, M. F., "A worldwide lunar radar time synchronization system," *Advanced Navigational Tech.* (papers of 14th AGARD/AVIONICS Panel Meet., Milan, Italy, September 12-15, 1967), *AGARD Conf. Proc. No. 28*, pp. 143-162, W. T. Blackband, (Ed.) (Technivision Services, Slough, England, February 1970).
- [198] Higa, W. H., "Time synchronization via lunar radar," *Proc. IEEE*, **60**, No. 5, pp. 552-557 (May 1972).
- [199] Baumgartner, W. S., Smith, J. R., Easterling, M. F., Arnold, R. E., Sato, E. R., Kron, M., Coffin, R. C., Martin, W. L., and Emerson, R., "Time-synchronization system," *JPL Space Programs Summary 37-43*, **III**, pp. 92-107 (JPL, Calif. Inst. of Technol., Pasadena, CA 91103, January 1967).
- [200] Higa, W. H., and Ward, S. C., "Moon-bounce time synchronization," *Proc. 2nd Ann. Precise Time and Time Interval (PTTI) Strat. Plan. Meet.* (USNO, Washington, DC 20390, December 10-11, 1970) **I**, pp. 111-118 (NTIS, AD 881014-L, 1971).
- [201] Coffin, R. C., Emerson, R. F., and Smith, J. R., "Time-synchronization system," *JPL Space Programs Summary 37-45*, **III**, pp. 72-75 (JPL, Calif. Inst. of Technol., Pasadena, CA 91103, May 1967).
- [202] Baugh, H. W., "DSN time-synchronization subsystem," *JPL Space Program Summary 37-53*, **II**, pp. 97-99 (JPL, Calif. Inst. of Technol., Pasadena, CA 91103, September 1968).
- [203] Baugh, H. W., "Clock synchronization system performance," *JPL Space Programs Summary 37-62*, **II**, pp. 116-118 (JPL Calif. Inst. of Technol., Pasadena, CA 91103, March 1970).
- [204] Wells, R., (JPL), Private communication (June 17, 1971).
- [205] ATA, "Airborne collision avoidance system, statement of airline policy and requirements, and a technical description of the system," Airline Air Traffic Control Committee, *CAS Tech. Working Group*, Air Transport Assoc. of Amer., *ANTC Rep. 117*, Revision 10 (May 1971).
- [206] Borrok, M. J., and Rider, D. C., "Results of the ATC CAS flight test program," *Navigation: J. Inst. Nav.*, **17**, No. 3, pp. 278-289 (Fall 1970).
- [207] Holt, J. M., "Avoiding air collisions," *Science and Technol.*, No. 78, pp. 56-63 (June 1968).
- [208] Borrok, M. J., "EROS in operation," *Navigation: J. Inst. Nav.*, **14**, No. 3, pp. 315-320 (Fall, 1967).
- [209] White, F. C., (Ed.), Special Section on Aircraft Collision Avoidance, *IEEE Trans. on Aersp. and Electron. Syst.*, **AES-4**, No. 2, pp. 234-314 (March 1968).
- [210] Friedlander, G. D., "At the crossroads in air-traffic control," *IEEE Spectrum*, Pt. I, **7**, No. 6, pp. 26-40 (June 1970); Pt. II, **7**, No. 7, pp. 69-83 (July 1970); Pt. III, **7**, No. 8, pp. 76-89 (August 1970).
- [211] Jaycox, R. L., "Collision avoidance system synchronization," *IEEE Trans. on Aersp. and Electron. Syst.*, **AES-4**, No. 2, pp. 257-264 (March 1968).
- [212] McIntire, O. E., (Chairman), *Utilization of Time/Frequency in Collision Avoidance Systems (CAS)* (Minutes of CAS-FAA Meet., Washington, DC 20590, August 27-28, 1968) 125 pages (NTIS, AD 681 881, 1968).
- [213] Weihe, V. I., "Frequency and time in air traffic control and collision avoidance applications," *Proc. 25th Ann. Symp. on Frequency Control* (U.S. Army Electronics Command, Ft. Monmouth, NJ 07703, April 26-28, 1971., pp. 82-87 (NTIS, AD 746211, 1971).
- [214] Perkinson, R. E., and Watson, F. D., "Airborne collision avoidance and other applications of time/frequency," *Proc. IEEE*, **60**, No. 5, pp. 572-579 (May 1972).
- [215] Hyatt, R., Throne, D., Cutler, L. S., Holloway, J. H., and Mueller, L. F., "Performance of newly developed cesium beam tubes and standards," *Proc. 25th Ann. Symp. on Frequency Control* (U.S. Army Electronics Command, Ft. Monmouth, NJ 07703, April 26-28, 1971), pp. 313-324 (NTIS, AD 746211, 1971).
- [216] Brennan, J. L., "Time and frequency relating to collision avoidance systems," *Proc. 3rd Ann. DOD Precise Time and Time Interval (PTTI) Strat. Plan. Meet.* (USNO, Washington, DC 20390, November 16-18, 1971), pp. 305-316 (USNO, Washington, DC 20390, 1972) (NTIS, AD 758739).
- [217] Roth, S. H., "Time and frequency applications to automatic vehicle location," *Proc. IEEE (Let.)*, **60**, No. 5, pp. 637-638 (May 1972).
- [218] Claggett, B. D., "Study of precision fixing requirements in special purpose marine operations," *Geonautics, Inc., Contract Rep. DOT-CG-83291-A*, 153 pages (NTIS, AD 690 929, July 1969).
- [219] Cady, W. G., "An international comparison of radio wavelength standards by means of piezo-electric resonators," *Proc. IRE*, **12**, No. 6, pp. 805-816 (December 1924).
- [220] Dellinger, J. H., "The status of frequency standardization," *Proc. IRE*, **16**, No. 5, pp. 579-592 (May 1928).
- [221] Marrison, W. A., "The crystal clock," *Nat. Acad. Science*, **16**, pp. 496-507 (July 1930).
- [222] Mason, W. P., "Quartz crystal applications," *Bell Sys. Tech. J.*, **22**, No. 2, pp. 178-223 (July 1943).
- [223] Cady, W. G., *Piezoelectricity*, Chaps. XIII-XIX, General Bibliography, pp. 284-509, 755-787 (McGraw Hill Book Co., Inc., New York, NY 10020, 1946).
- [224] Marrison, W. A., "The evolution of the quartz crystal clock," *Bell Sys. Tech. J.*, **27**, No. 3, pp. 510-588 (July 1948).
- [225] Lewis, F. D., "Frequency and time standards," *Proc. IRE*, **43**, No. 9, pp. 1046-1068 (September 1955).
- [226] Gerber, E. A., and Sykes, R. A., "State of the art - quartz crystal units and oscillators," *Proc. IEEE*, **54**, No. 2, pp. 103-116 (February 1966) (see chap. 2).
- [227] Austron, "Austron model 2010B disciplined frequency standard," 7 pages (Austron, Austin, TX 78753, November 1971).
- [228] Essen, L., and Parry, J. V. L., "Comparison of caesium frequency standards of different construction," *Nature (Let.)*, **182**, No. 4627, pp. 41-42 (July 5, 1958).
- [229] Reder, F. H., and Winkler, G. M. R., "World-wide clock synchronization," *IRE Trans. on Military Electron.*, **MIL-4**, No. 2-3, pp. 366-376 (April-July 1960).
- [230] Reder, F. H., Winkler, G. M. R., and Bickart, C., "Results of a long-range clock synchronization experiment," *Proc. IRE*, **49**, No. 6, pp. 1028-1032 (June 1961).
- [231] Barnes, J. A., and Fey, R. L., "Synchronization of two remote atomic time scales," *Proc. IEEE* (Corresp.), **51**, No. 11, p. 1665 (November 1963).
- [232] Bagley, A. S., and Cutler, L. S., "A new performance of the 'flying clock' experiment," *Hewlett-Packard J.*, **15**, pp. 1-5 (HP, Palo Alto, CA 94304, July 1964).
- [233] Bodily, L., "Correlating time from Europe to Asia with flying clocks," *Hewlett-Packard J.*, **16**, pp. 1-8 (HP, Palo Alto, CA 94304, April 1965).
- [234] Bodily, L., Hartke, D., and Hyatt, R. C., "World-wide time synchronization," *Hewlett-Packard J.*, **17**, pp. 13-20 (HP, Palo Alto, CA 94304, August 1966).
- [235] Bodily, L. N., and Hyatt, R. C., "'Flying clock' comparisons extended to East Europe, Africa and Australia," *Hewlett-Packard J.*, **19**, No. 4, pp. 12-20 (HP, Palo Alto, CA 94304, December 1967).
- [236] Philibert, V., "The cesium-beam atomic clock," *Electron. World*, **83**, No. 6, pp. 40-41, 67 (June 1970).
- [237] USNO, "U.S. Naval Observatory time reference stations," Time Service Announcement, Series **14**, No. 1, 2 pages (USNO Washington, DC 20390, April 17, 1968) (see chap. 11 - ann. 11.E.1).
- [238] Hall, R. G., Private communication (January 1972).
- [239] NBS, "Nation gets unified time system," *Nat. Bur. Stand. (U.S.) Tech. News Bull.*, **53**, No. 2, p. 34 (USGPO, February 1969).

- [240] Markowitz, W., "Air/ground synchronization," *USNO Report* (August 1966).
- [241] Besson, J., "Comparison of national time standards by simple overflight," *IEEE Trans. on Instrum. and Meas.*, **IM-19**, No. 4, pp. 227-232 (November 1970).
- [242] CCIR, "International comparison of atomic time scales," *CCIR Study Group 7 Doc. 7/8-E*, Rep. 363-1, 4 pages (ITU, Geneva, Switzerland, December 1970).
- [243] Tilson, S., "Pulsars may be neutron stars," *IEEE Spectrum*, **7**, No. 2, pp. 42-55 (February 1970).
- [244] Pacini, F., and Rees, M. J., "Rotation in high energy astrophysics," *Scientific American*, **228**, No. 2, pp. 98-105 (February 1973).
- [245] Smith, S. G., "The pulsars," *Telecommunications J.*, **37**, No. 11, pp. 750-752 (November 1970).
- [246] Hewish, A., Bell, S. J., Pilkington, J. D. H., Scott, P. F., and Collins, R. A., "Observations of a rapidly pulsating radio source," *Nature*, **217**, No. 5130, pp. 709-713 (February 24, 1968).
- [247] Manchester, R. N., "Pulsars: Observations and current investigation," *1971 IEEE International Conv. Digest, No. 71C8-IEEE*, pp. 154-155 (March 1971).
- [248] Staelin, D. H., and Reifenstein, E. C., III, "Pulsating radio sources near the Crab Nebula," *Science*, **162**, No. 3861, pp. 1481-1482 (December 27, 1968).
- [249] Cocke, W. J., Disney, M. J., and Taylor, D. J., "Discovery of optical signals from Pulsar NP 0532," *Nature*, **221**, No. 5180, pp. 525-527 (February 9, 1969).
- [250] Papaliolios, C., Carleton, N. P. and Horowitz, P., "Absolute time-of-arrival measurements of optical pulses from the Crab pulsar," *Nature*, **228**, No. 5270, pp. 445-450 (October 31, 1970).
- [251] Fritz, G., Henry, R. C., Meekins, J. F., Chubb, T. A., and Friedman, H., "X-ray pulsar in the Crab Nebula," *Science*, **164**, No. 3880, pp. 709-712 (May 9, 1969).
- [252] Duthie, J. G., and Murdin, P., "Accurate timing of light flashes from the pulsar in the Crab Nebula during the 1969-1970 season," *Astrophys. J.*, **163**, No. 1, pp. 1-10 (January 1, 1971).
- [253] Allan, D. W., "Time transfer using near-synchronous reception of optical pulsar signals," *Proc. IEEE (Lett.)*, **60**, No. 5, pp. 625-627 (May 1972).
- [254] Horowitz, P., Papaliolios, C., Carleton, N. P., Nelson, J., Middleditch, J., Hills, R., Cudaback, D., Wampler, J., Boyton, P. E., Groth, E. J., Partridge, R. B., Wilkinson, D. T., Duthie, J. G., and Murdin, P., "Optical time-of-arrival measurements from the Crab pulsar: comparison of results from four observatories," *Astrophys. J.*, **166**, pp. L91-L93 (June 15, 1971).
- [255] Hastings, H. F., "Transmission to Naval Observatory of reference derived from hydrogen masers at NRL," *NRL Progress Rep.*, pp. 46-47 (March 1965).
- [256] Koide, F. K., "Standard frequency transmission over telephone line," *Instrum. and Control Syst.*, **39**, No. 4, pp. 123-128 (April 1966).
- [257] Koide, F. K., "Aerospace frequency and time distribution system," *Meas. and Data*, **1**, No. 3, pp. 98-108 (May/June 1967).
- [258] Koide, F. K., Private communication (Autonetics, California, January 1973).
- [259] Grimsley, S. W., and Miller, M. J., "Phase comparison of frequency standards," *Proc. IREE (Australia)*, **29**, No. 1, pp. 14-17 (January 1968).
- [260] Redgeman, P. G., and Watson, D. W., "Very-long-wave phase differences between spaced aerial systems," *Proc. Inst. Elec. Eng. (London)*, **94**, No. 6, Pt. III A, pp. 1016-1022 (1947).
- [261] Curtwright, J. B., "Intra-DSCC microsecond timing using a communication microwave link," *JPL Space Programs Summary* 37-59, **II**, pp. 154-157 (JPL, Calif. Inst. of Technol., Pasadena, CA 91103, September 20, 1969).
- [262] Cohn, N., *Control of generation and power flow on interconnected systems*, 132 pages (John Wiley and Sons, Inc., New York, NY 10016, 1966).
- [263] Cohn, N., "Techniques for improving the control of bulk power transfers on interconnected systems," *IEEE Trans. on Power Applicat. Syst.*, **PAS-90**, No. 6, pp. 2409-2419 (November/December 1971).
- [264] Allan, D. W., Machlan, H. E., and Marshall, J., "Time transfer using nearly simultaneous reception times of a common transmission," *Proc. 26th Ann. Symp. Frequency Control (U.S. Army Electronics Command, Ft. Monmouth, NJ 07703, June 6-8, 1972)*, pp. 309-316 (Electron. Ind. Assn., Washington, DC 20006, 1972).
- [265] Palmer, W., "The Omega navigation system as a source of frequency and time," *Proc. 24th Ann. Symp. on Frequency Control (U.S. Army Electronics Command, Ft. Monmouth, NJ 07703, April 27-29, 1970)*, pp. 345-360 (Electron. Ind. Assn., Washington, DC 20006, 1970).
- [266] Dejager, C., and Jappel, A., (Eds.), "Commission 31: Time (l'Heure), Report of Meetings 19, 21, 24 and 26, August 1970," *Trans. IAU, XIV-B*, page 196 (D. Reidel Publishing Co., Holland, 1971).
- [267] Kaiser, A. B., "An explanation of VLF diurnal phase change observations," *Radio Science*, **4**, No. 1, pp. 17-21 (January 1969).
- [268] Budden, K. G., *Radio Waves in the Ionosphere*, 542 pages (Cambridge University Press, London, England, 1961).
- [269] Jöhler, J. R., "Loran-C, D phase corrections over irregular, inhomogeneous terrain-simplified computer methods," *ESSA Tech. Report ERL 116-ITS 83*, 55 pages (USGPO, April 1969); also see ref. [13].
- [270] Berry, L. A., "Wave hop theory of long distance propagation of low frequency radio waves," *Radio Science (J. Research) NBS/USNC, URSI*, **68D**, No. 12, pp. 1275-1284 (December 1964).
- [271] Belrose, J. S., "The lower ionosphere—a review," *Proc. Conf. on MF, LF, and VLF Radio Propagation (London, England, November 8-10, 1967)*, *Inst. Elec. Eng. (London) Conf. Publ. No. 36*, pp. 331-339 (1967).
- [272] Kobayashi, S., Nakajima, M., and Sato, T., "Accuracy of the domestic time synchronization by the reception of JFY signals at long distances," *Radio Res. Lab. Rev.*, **14**, No. 72, pp. 373-377 (May 1968) (in Japanese).
- [273] Haydon, G. W., Lucas, D. L., and Hanson, R. L., "Technical considerations in the selection of optimum frequencies for high frequency skywave communication services," unpublished report (1962).
- [274] Bullington, K., "Radio propagation at frequencies above 30 megacycles," *Proc. IRE*, **35**, No. 10, pp. 1122-1136 (October 1947).
- [275] Lawrence, R. S., Little, C. G., and Chivers, H. J. A., "A survey of ionospheric effects upon earth-space radio propagation," *Proc. IEEE*, **52**, No. 1, pp. 4-27 (January 1964).
- [276] Aarons, J., Whitney, H. E., and Allen, R. S., "Global morphology of ionospheric scintillations," *Proc. IEEE*, **59**, No. 2, pp. 159-172 (February 1971).
- [277] Reed, H. R., and Russell, C. M., *Ultra High Frequency Propagation*, 562 pages (Boston Tech. Publ., Cambridge, MA 02139, 1964).
- [278] Bean, B. R., and Dutton, E. J., *Radio Meteorology, Nat. Bur. Stand. (U.S.) Monogr. 92*, 435 pages (USGPO, 1966).
- [279] Dougherty, H. T., "A survey of microwave fading mechanisms, remedies, and applications," *ESSA Tech. Rep. ERL 69-WPL4*, 82 pages (USGPO, April 1968).
- [280] Thompson, W. I., III, "Atmospheric transmission handbook: A survey of electromagnetic wave transmission in the earth's atmosphere over the frequency (wavelength) range 3 kHz (100 km)-3000 THz (0.1 micron m)," *Dept. of Trans. Tech. Rep. DOT-TSC-NASA-71-6*, 296 pages (NTIS, N71-20121, February 1971).
- [281] Guinot, B., Feissel, M., and Graveaud, M., *Bureau International de l'Heure Annual Report-1971* (BIH, Paris, France, 1972).

## ANNEX 10.A. CHARACTERISTICS OF RADIO FREQUENCY BANDS 4 THROUGH 10

Frequency Band	Frequency Ranges	Wave Length Range	Typical Stability	Typical Uses	Factors Affecting Propagation	General Description of Frequency Band Transmission
VLF (Very Low Frequency) Band 4	3-30 kHz  Omega (10.2 to 13.6 kHz) Communications (16 to ~26 kHz) Time/Frequency (20 kHz)	$10^5 - 10^4$ m	pts in $10^{11}$ per day or better (10-30 kHz)	Navigation; Time/Frequency Disseminations; Communications	Time of day; propagation over land or water; ground conductivity; direction of propagation; noise; solar activity; atmospheric disturbances; polar cap and varied latitude paths; daily variation in height of ionosphere causes diurnal shifts at sunrise and sunset. At long distances from a transmitter (>10,000 km), the long path signal can interfere with the short path signal. Nighttime propagation shows increased variation over daytime propagation. Dispersion effects (phase velocity of radio signal varies as a function of its frequency) cause phase and group velocities to differ and must be evaluated in timing systems using multi-frequency techniques. Mode interference at sunrise and sunset can cause cycle "slips", especially at high frequencies in band.	VLF signals propagate between the bounds of the ionospheric D layer and earth and are thus guided around the curvature of the earth to great distances with low attenuation and excellent stability. Diurnal changes are very abrupt when transmitter and receiver are near or at the same longitude; the amount of the diurnal change varies with the distance of the path travel and carrier frequency, and the diurnal phase shift is predictable to several microseconds [34, 267]. VLF propagation has been extensively studied and reported [11a, 12a, 268] and models have been developed for predicting phase delay and signal strength at varying distances and transmitter power. It has been found both experimentally and theoretically that the phase variation with distance tends to become more regular in the 10-20 kHz region as the distance from the transmitter increases. The high Q of VLF antennas precludes a rapid pulse rise which limits envelope timing to about 1 ms. VLF signals are broadcast from worldwide transmitters radiating about 1 kW to 1 MW power. Stable VLF signal reception, during daylight hours with totally sunlit path, permits day-to-day phase comparisons accurate to one or two $\mu$ s [30, 31, 46]. (Swanson and Kugel [59] describe both Omega and other VLF signals.)
LF (Low Frequency) Band 5	30-300 kHz Time/Frequency (40 to ~100 kHz) Loran-C (100 kHz) Stabilized Carrier Broadcast Stations (~90 to 200 kHz) mainly European stations	$10^4 - 10^3$ m	pts in $10^{11}$ per day (60-200 kHz) dependent on propagation path and distance) pts in $10^{13}$ per day for ground wave signals	Navigation; Time/Frequency Disseminations; Ionospheric Studies; Communications; Commercial Broadcasts	Propagation over water and land paths shows variation; time of day; ground conductivity; solar activity; atmospheric disturbances; interactions of modes during sunrise and sunset cause cycle "slips"; daily ionospheric height changes cause diurnal changes at sunrise and sunset. Appreciable dispersion occurs in ground wave propagation. LF, in contrast to VLF, allows pulsed systems because lower Q antennas can be used. Pulsed transmissions allow separation of ground wave from sky wave signals, so that only ground conductivity and irregular terrain effects need be considered.	LF continuous wave (CW) propagation is similar to that of VLF signals. The higher frequency broadcasts are most stable within ground wave distance of the transmitter (about 500 km). LF signals generally show greater attenuation with distance than VLF signals. A wider bandwidth permits pulsed signals at 100 kHz. This allows separation of the stable ground wave pulse from the variable sky wave pulse up to 1500 km and overseas ranges to more than 2000 km. LF signals are broadcast from North America, Europe, and Japan with transmitter radiated powers of 5 to 400 kW. Stable CW LF signal reception during daylight hours with a totally sunlit path can give phase comparisons to several $\mu$ s for paths greater than 5000 km [54]. LF envelope time measurements are good to about 40-50 $\mu$ s [67] while LF ground wave signals provide precisions of nanoseconds and accuracies of about a $\mu$ s. LF propagation characteristics have been described by Johler, Berry, and Belrose [269-271]. (Potts and Wieder [98] describe the Loran-C navigation system and its use for time dissemination.)
MF (Medium Frequency) Band 6	300 kHz-3 MHz Commercial Station Broadcasts (535-1605 kHz) Loran-A (1.85-1.95 MHz)	$10^3 - 10^2$ m	pts in $10^7$ (Loran-A can provide better stability in some cases)	Commercial Broadcasts; Maritime Services; Navigation (Loran-A); Standard Frequency Broadcasts	During daytime, absorption in the D layer eliminates the sky wave. At night, reflections occur from E and F layers resulting in reception of sky waves at distant points. Moving layers and interaction of modes can cause severe distortion. Atmospheric noise varies greatly, being especially high during summer nights. In urban areas, man-made noise can dominate.	The MF band is most useful within ground wave distance (less than 150 km in the day, perhaps half of that at night). It will support signals with a sufficient bandwidth for time pulses, especially at the high end. Coarse time signals are accurate to about 500 $\mu$ s. Time comparison accuracies of $\pm 30 \mu$ s are expected from JFY broadcasts at reception distances of 1000 km using 2.5 MHz signals [272]. A commercial broadcast station in Tennessee, U.S.A. (650 kHz) is phase stabilized to several $\mu$ s/day of the NBS WWVB broadcasts [173], providing a local relay standard frequency service. Standard frequency and time broadcasts are transmitted at radiated powers ranging from less than 1 kW to about 5 kW.
HF (High Frequency) Band 7	3,0-30 MHz Worldwide Short Wave Broadcasts	$10^2 - 10$ m	pts in $10^7$	Standard Frequency Broadcasts; Communications; Short Wave Broadcasts	Ionospheric reflections from E, F1, or F2 layers, depending on distance, frequency, time of day, and conditions of the ionosphere (quiet or disturbed). Distant reception may be through multiple hops (ionosphere-ground reflections). Movement of reflection points in the ionosphere and interference between hop modes may cause severe distortion. Other factors include the 11-year sunspot cycle, seasonal and diurnal variations, global location, solar flares, ionospheric storms, magnetic storms, sporadic E, etc. Atmospheric noise varies widely, being highest during summer nights. Man-made noise may predominate.	This is the so-called short wave band. The ionosphere absorbs little energy, resulting in worldwide reception. Movement of reflection points can introduce Doppler shifts and fluctuations in amplitude and phase, degrading accuracy to pts in $10^7$ . For more accurate reception, one is limited to the ground wave at distances less than 160 km during the day, perhaps half that at night. A 30 MHz frequency is the approximate upper limit for usual sky wave propagation. Sufficient bandwidth is available to enable time pulse transmission in this frequency band. Many studies of HF band have been made [14, 273]. Computer programs can predict maximum usable frequencies (MUF), optimum frequencies (FOT), and critical frequency with given circuit reliability and service [85] for different locations, directions of propagation, time of day, season, sunspot activity, etc. Winkler [83] notes that WWV signals received at the USNO, Washington, DC (2400 km land path) showed day-to-day variations of $\sim 200 \mu$ s if the measurement is duplicated at the same time every day on the same frequency. Receiving equipment and antennas are simple and inexpensive. Standard frequency and time are transmitted at radiated powers that range from 0.5 - 20 kW.
VHF (Very High Frequency) Band 8	30-300 MHz	10-1 m	pts in $10^{12}$ (Line-of-sight)	Television; FM Commercial Broadcasts; Satellite Experimental Time Broadcasts; Communication Satellites	Influenced principally by terrain, it is difficult to propagate signals over hills because of diffraction effects. Signals can also reflect from tall buildings, mountains, etc., causing multipath distortion and fading. Other influencing factors include atmospheric inhomogeneities; turbulence, ducts, sporadic E, in earth-satellite links, the ionosphere also introduces Faraday rotation, scintillation, and dispersion. Propagation path for satellite signals essentially reciprocal. Angle of signal transmission will determine, to some extent, accuracy obtainable from satellite signals because of the length of ionospheric path. Man-made and galactic noise are both fairly low.	Signals in this band are generally limited to line-of-sight and near line-of-sight (usually <150 km); however, ionospheric scatter (1000 km or more) and tropospheric scatter (<1000 km) systems exist. Signals penetrate the ionosphere with low loss of stability (at least at mid-latitudes). Satellite transmitter power is relatively low (40-100W), and can transfer signals to nearly a whole hemisphere [154]. TV transmissions show potential for precise time broadcasts in a local service area [116, 121, 133]. Propagation characteristics have been described by Bullington; Lawrence, et al.; Aarons, et al. [274-276]. For low power applications, the cost of antenna and receiving equipment is fairly low. Directional antennas, capable of responding to varied polarizations, give optimum response to VHF satellite signals.
UHF (Ultrahigh Frequency) Band 9	300 MHz-3,0 GHz	1-0.1 m	pts in $10^{12}$ (Line-of-sight)	Television; Communications; Time/Frequency Comparisons; Radar	Diffraction can cause serious attenuation. Otherwise, the major effects are due to atmospheric inhomogeneities. The index of refraction is a function of water vapor content, temperature, and pressure, and varies from point to point and instant to instant. Phase scintillations show RMS jitter directly proportional to frequency. In earth-satellite links, refraction through the atmosphere takes place primarily in the lower 20 km, and most effects on satellite timing are at low elevation angles. Ionospheric effects are almost negligible. The band is characterized by low noise density (man-made noise predominates); receiver thermal noise and galactic noise may also be important.	Most of the troposcatter systems are found in this band. These are high powered, point-to-point communication links from 100 to almost 1000 km long. Otherwise, signals are limited to line-of-sight (usually less than 100 km). Such signals are very stable, although multipath distortion and fading may be present. Propagation characteristics are described by Reed and Russell; Bean and Dutton [277, 278]. Many of the environmental satellites and most of the broadcast satellites are expected to operate in this band. UHF TV is available and can be used in ways similar to TV at VHF. Relatively low power of transmission is required for hemispheric coverage of satellite signals with excellent stability. Directional antennas are advisable; both antenna and equipment complexity tend to increase, especially at the higher frequencies.
SHF (Super High Frequency) Band 10	3,0-30 GHz	10-1 cm	pts in $10^{12}$ (Line-of-sight)	Telecommunications Networks; Time/ Frequency Comparisons; Navigation Satellites; Communication Satellites; Radar	Diffraction causes serious attenuation. Multipath phenomena become factors of concern to users of this frequency band. Atmospheric variations give rise to subrefractive and super-refractive conditions, ground based and elevated ducts, all of which may lead to anomalous propagation. At the higher end of the band, rainfall attenuation and scatter may be limiting factors, and molecular absorption by oxygen and water vapor begins to be significant. Noise density is very low; man-made noise is comparable to receiver thermal noise; at 10 GHz, the sky brightness temperature begins to dominate, particularly at low elevation angles. Ionosphere appears transparent to these frequencies and effects are nearly non-existent.	This is the so-called microwave or centimeter wave band. Signals are limited to line-of-sight, and the microwave relay systems are composed of many short (40-60 km) hops or links. The long haul lines of the common carriers usually use such systems. They seem to show long range stabilities of several $\mu$ s [125, 128]. Microwave links are also used to relay time signals from a source to a remote broadcast terminal. A 32 km link at the USNO uses signals in the 7 GHz region (radiated power 7 W) and shows phase resolution less than 10 ns and a time setting capability better than 100 ns [169]. Antennas are usually highly directive; they and the system equipment tend to be both expensive and complex. At the higher end, where molecular absorption is present, there are nevertheless "windows" which enable stable signals to be transmitted between earth and space with little signal degradation. Propagation characteristics are described by Dougherty and Thompson [279, 280].

# ANNEX 10.B. CHARACTERISTICS OF STANDARD FREQUENCY AND TIME SIGNALS IN ALLOCATED BANDS<sup>(1)</sup>

MAP NO.	STATION			TRANSMITTER			CARRIER <sup>(2)</sup>				TIME SIGNALS <sup>(2)</sup>		PERIOD OF OPERATION	
	SEE FIGURE 10.4	CALL SIGN	APPROXIMATE LOCATION	LONGITUDE LATITUDE	ANTENNA TYPE	RADIATED CARRIER POWER kW	NUMBER OF SIMULTANEOUS TRANSMISSIONS	STANDARD FREQUENCIES MHz	MODULATION Hz	ACCURACY PTS IN 10 <sup>10</sup>	TIME PULSES pps	DURATION MIN	TIME SIGNAL ADJUSTMENT	DAYS PER WEEK
1	ATA	New Delhi, INDIA	+28°34'N -77°19'E	HORIZONTAL DIPOLE	2	1	10	1,1000	±200	YES	CONTINUOUS	VLF STEERING PORTABLE CLOCK	5	5
2	FFH	Paris, FRANCE	+48°32'N -02°27'E	RADIATING MAST	5	1	2.5	1,1000	±2	YES	30/h	UTC	5(M-F)	8.5
3	IAM	Rome, ITALY	+41°52'N -12°27'E	VERTICAL 1/4	1	1	5	1,1000	±0.5	YES	10/15	UTC	6	2
4	IBF	Torino, ITALY	+45°02'N -07°46'E	VERTICAL 1/4	5	1	5	1,1000	±0.5	YES	CONTINUOUS	UTC	7	2.75
5	JG2AR	Tokyo, JAPAN	+35°42'N -139°31'E	OMNI-DIRECTIONAL	3	1	0.02	1	±1		CONTINUOUS	NON-OFFSET CARRIER	5(M-F)	2 (0530-0730 UT)
6	JJY	Tokyo, JAPAN	+35°42'N -139°31'E	VERTICAL 1/2 DIPOLES; (1/2 DIPOLE, TOP-LOADED FOR 2.5 MHz)	2		2.5; 5 10; 15	1,600; 1000; 1600	±0.5	YES	CONTINUOUS	UTC	7	24 (9 MIN INTERRUPTION PER h)
7	L0L	Buenos Aires, ARGENTINA	-34°37'S -58°21'W	HORIZONTAL 3-WIRE FOLDED DIPOLE	2	3	5; 10; 15	1,440; 1000	±0.2	YES	CONTINUOUS	UTC	7	5
8	MSF	Rugby, UNITED KINGDOM	+52°22'N +01°11'W	HORIZONTAL QUADRANT DIPOLES; (VERTICAL MONOPOLE, 2.5 MHz)	0.5	3	2.5; 5; 10	1,1000	±1	YES	5/10	UTC	7	24
9	OMA	Praha, CZECHOSLOVAK S.R.	+50°07'N -14°35'E	T	1	1	2.5	1,1000	±10		15/30	UTC	7	24
10	RWM/RES	Moskva, U.S.S.R.	+55°45'N -37°18'E		20	1	5; 10; 15	1,1000	±50	YES	10/2 h	UTC (UT1-UTC TO 10 ms)	7	19
11	WWV (3)	Fort Collins, COLORADO U.S.A.	+40°41'N +105°02'W	VERTICAL 1/2 DIPOLES	2.5-10	6	2.5; 5; 10 15; 20; 25	1,100; 440; 500; 600; 1000; 1500	±0.1	YES	CONTINUOUS	UTC	7	24
12	WWVH (3)	Kaunoi, HAWAII U.S.A.	+ 21°59'N +159°46'W	PHASED VERTICAL 1/2 DIPOLE ARRAYS (VERTICAL 1/2 FOR 2.5 MHz)	2.5-10	5	2.5; 5; 10 15; 20	1,100; 440; 500; 600; 1200; 1500	±0.1	YES	CONTINUOUS	UTC	7	24
13	WWVL (4)	Fort Collins, COLORADO U.S.A.	+40°41'N +105°03'W	TOP-LOADED VERTICAL	1.8	1	0.02	NIL	±0.1	NIL	NIL	NON-OFFSET CARRIER	7	24
14	ZLFS	Lower Hutt, NEW ZEALAND	-41°14'S -174°55'E		0.3	1	2.5	NIL	±1	NIL	NIL		1	3
15	ZUD	Olifantsfontein, REPUBLIC OF SOUTH AFRICA	-25°58'S -28°14'E	VERTICAL MONOPOLE	4	1	5	1,1000	±0.5	YES	CONTINUOUS	UTC	7	24
16	ZUD	Johannesburg, REPUBLIC OF SOUTH AFRICA	-26°11'S -28°04'E	HORIZONTAL DIPOLE	0.25	1	10	1,1000	±0.5	YES	CONTINUOUS	UTC	7	24

- NOTES: (1) PRINCIPAL INFORMATION EXTRACTED FROM CCIR PROC. XIth PLENARY ASSEMBLY (NEW DELHI, INDIA, 1970). VOL. III [73] AND THE BIH ANNUAL REPORT FOR 1971 [281]. WE REFER THE READER TO THESE DOCUMENTS FOR ADDITIONAL NOTES ON VARIATIONS OF SOME BROADCASTS, AS WELL AS TRANSMISSION FORMATS.
- (2) UTC TIME ADJUSTMENT AND ZERO OFFSET OF CARRIER FREQUENCIES (ATOMIC FREQUENCY) COMMENCED JANUARY 1, 1972. STEP ADJUSTMENTS OF 1 s (LEAP SECONDS) WILL BE MADE AT DESIGNATED TIMES TO PREVENT UT1 DIFFERING FROM UTC BY MORE THAN ±0.7s. A SPECIAL CODE IS DISSEMINATED WITH TIME SIGNALS TO GIVE DIFFERENCE UT1 - UTC TO 100 ms. THE USSR BROADCASTS ALSO WILL GIVE DIFFERENCE TO 10 ms. TIME SIGNALS OF ALL STANDARD FREQUENCY BROADCASTS ARE TO BE MAINTAINED WITHIN ±1 ms. OF UTC.
- (3) AN IRIG-H (MODIFIED) BCD TIMING CODE IS TRANSMITTED CONTINUOUSLY. THIS CODE IS PRODUCED AT A 1 pps RATE AND CARRIED ON A 100 Hz SUBCARRIER, AT A COMPLETE TIME FRAME OF 1 min. THE CODE GIVES UTC IN s, min, h AND DAY OF YEAR AND CONTAINS 60/min CLOCKING RATE, 6/min POSITION IDENTIFICATION MARKERS, AND A 1/min REFERENCE MARKER. THE 100 Hz IS SYNCHRONOUS WITH THE CODE PULSES, PROVIDING 10 ms RESOLUTION.
- (4) WWVL CAN BE USED FOR SYNCHRONIZATION; IT IS AN EXPERIMENTAL BROADCAST ONLY AND IS ON AN INTERMITTENT TRANSMISSION SCHEDULE.



# ANNEX 10.C. CHARACTERISTICS OF STABILIZED FREQUENCY AND TIME-SIGNAL EMISSIONS OUTSIDE ALLOCATED FREQUENCY ASSIGNMENTS (1)

MAP NO.	STATION			TRANSMITTER			CARRIER (2)				TIME SIGNALS (2)		PERIOD OF OPERATION	
	SEE FIGURE 10.4	CALL SIGN	APPROXIMATE LOCATION	LONGITUDE LATITUDE	ANTENNA TYPE	RADIATED CARRIER POWER KW	# OF STIMULATED-TONEUS BROADCASTS	STABILIZED FREQUENCIES KHz	MODULATION Hz	ACCURACY PTS IN 10 <sup>10</sup>	TIME PULSES pps	DURATION MIN	TIME SIGNAL ADJUSTMENT	DAYS PER WEEK
A		Allouis, FRANCE	+47°10'N -02°12'E	OMNI-DIRECTIONAL	500	1	163.84	NIL	±0.5	NIL	NIL	ZERO OFFSET CARRIER	7	24
B	Chu	Ottawa, CANADA	+45°18'N +75°45'W	FOLDED DIPOLES & RHOMBIC	3; 5	3	3330;7335; 14670	1;1000	±0.2	YES	CONTINUOUS FRENCH VOICE ANNOUNCEMENT	UTC	7	24
C		Donebach, F.R. of GERMANY	+49°34'N -09°11'E	OMNI-DIRECTIONAL	70	1	151	NIL	±0.3	NIL	NIL	ZERO OFFSET CARRIER	7	24
D	DCF77	Mainflingen, F.R. of GERMANY	+50°01'N -09°00'E	OMNI-DIRECTIONAL	12	1	77.5	1;440	±0.2	YES	CONTINUOUS	ZERO OFFSET CARRIER	7	24
E		Droitwich, UNITED KINGDOM	+52°16'N +02°09'W	T	400	1	200	NIL	±0.2	NIL	NIL	ZERO OFFSET CARRIER	7	22
F	GBR	Rugby, UNITED KINGDOM	+52°22'N +01°11'W	OMNI-DIRECTIONAL	60(EST.)	1	15.95 16.00	1	±0.2	A1 TYPE	4 x 5 PER DAY	UTC	7	22 (OFF 1300-1430 UT DAILY)
G	HBG	Prangins, SWITZERLAND	+46°24'N -06°15'E	OMNI-DIRECTIONAL	20	1	75	1	±0.2	CARRIER INTERRUPTION	CONTINUOUS	UTC	7	24
H	JJF-2 JGZAS	Kemigawa, Chiba C JAPAN	+35°38'N -140°04'E	OMNI-DIRECTIONAL	10	1	40	NIL	±0.5	NIL	NIL	UTC	7	24
I	MSF	Rugby, U.K.	+52°22'N +01°11'W	OMNI-DIRECTIONAL	50	1	60	1	±0.2	CARRIER INTERRUPTION	CONTINUOUS	UTC	7	24
J	NAA (4)	Cutler, MAINE U. S. A.	+44°39'N +67°17'W	OMNI-DIRECTIONAL	1000 (EST.)	1	17.8	NIL	±0.5	NIL	NIL	UTC	7	24
K	NBA (4)	Balboa, Panama Canal Zone U. S. A.	+09°04'N +79°39'W	OMNI-DIRECTIONAL	150 (EST.)	1	24	1	±0.5	CW TIME PULSES	5 EVERY EVEN h EXCEPT 2400	UTC	7	24
L	NDT (4)	Yosami, JAPAN	34°58'N 137°01'E		50	1	17.4	NIL			NIL	UTC		
M	NPG/ NLK (4)	Jim Creek, WASHINGTON U. S. A.	+48°12'N +121°55'W	OMNI-DIRECTIONAL	250 (EST.)	1	18.6	NIL	±0.5	NIL	NIL	UTC	7	24
N	NPM (4)	Lualaba, HAWAII U. S. A.	+21°25'N +158°09'W	OMNI-DIRECTIONAL	140 (EST.)	1	23.4	NIL	±0.5	NIL	NIL	UTC	7	24
P	NSS (4)	Annapolis, MARYLAND U. S. A.	+38°59'N +76°27'W	OMNI-DIRECTIONAL	100 (EST.)	1	21.4	1	±0.5	CW TIME PULSES	5 EVERY h	UTC	7	24
Q	NWC (4)	North West Cape, AUSTRALIA	+21°49'S -114°10'E	OMNI-DIRECTIONAL	1000 (EST.)	1	22.3	1	±0.5	FSK PULSES	2 BEFORE 0430,1630 (EXPERIMENTAL)	UTC	7	24
R	OMA	Podebrazy, CZECHOSLOVAK S. R.	+50°08'N -15°08'E	T	5	1	50	1	±10	CARRIER INTERRUPTION A1 TYPE	23 h PER DAY	UTC	7	24
S	RWM-RES	Moskva, U. S. S. R.	+55°45'N +37°18'E		20	1	100	1	±50	A1 TYPE	5 EVERY h EXCEPT 2000	UTC	7	21
T	SAZ	Enköping, SWEDEN	+59°35'N -17°08'E	YAGI (12 db)	0.1 (EST.)	1	10 <sup>5</sup>	NIL	±50	NIL	NIL	ZERO OFFSET CARRIER	7	24
U	SAJ	Stockholm, SWEDEN	+59°20'N -18°03'E	OMNI-DIRECTIONAL	0.1 (EST.)	1	1.5 x 10 <sup>5</sup>	NIL	±1	NIL	NIL	ZERO OFFSET CARRIER	1 (FRIDAY)	2 (0930-1130 UT)
V	VE9BBS (3)	Ottawa, CANADA	+45°22'N +75°53'W	TOP-LOADED VERTICAL	0.006-1.4 (DEPENDENT ON FREQ.)	1	16.9, 23-200	NIL	±0.3	NIL	NIL	UTC	7	24
W	VNG	Lyndhurst, VICTORIA AUSTRALIA	-38°03'S -145°16'E	OMNI-DIRECTIONAL	10	2	4500;7500 12000	1;1000	±1	YES	CONTINUOUS EXCEPT FOR SILENT PERIODS	UTC	7	24 (VARIES BY FREQUENCY)
X	WWVB	Fort Collins, COLORADO U. S. A.	+40°40'N +105°03'W	TOP-LOADED VERTICAL	13	1	60	1	±0.1	TIME CODE	CONTINUOUS	UTC	7	24
Y	ZUO	Johannesburg, REPUBLIC OF SOUTH AFRICA	-26°11'S -28°04'E	OMNI-DIRECTIONAL	0.05	1	10 <sup>5</sup>	1	±0.5		CONTINUOUS	UTC	7	24 (SILENT 15-25 MIN PAST h)

NOTES: (1) INFORMATION OBTAINED AS IN ANNEX B; IN ADDITION FROM REF. [74].

(2) AS NOTE (2) IN ANNEX B.

(3) EXPERIMENTAL LF STATION USED PRIMARILY FOR PROPAGATION STUDIES. FOR SCHEDULE OF FREQUENCIES BROADCAST, CONTACT DR. J. BELROSE, DEPARTMENT OF COMMUNICATIONS, SHIRLEY BAY, ONTARIO, CANADA.

(4) THESE STATIONS ARE USED PRIMARILY FOR COMMUNICATION. TRANSMISSIONS ARE REFERENCED TO C<sub>s</sub> FREQUENCY STANDARDS AND ARE USEFUL FOR FREQUENCY SYNCHRONIZATION. STATION CHARACTERISTICS ARE SUBJECT TO CHANGE; HOWEVER, CHANGES ARE ANNOUNCED IN ADVANCE TO INTERESTED USERS BY USNO, WASHINGTON, D.C., U.S.A.

(5) FORMAT IN PLANNING STAGE.

# ANNEX 10.D. CHARACTERISTICS OF FREQUENCY STABILIZED NAVIGATION SYSTEMS USEFUL FOR TIME/FREQUENCY COMPARISON<sup>(1)</sup>

STATION <sup>(2)</sup>				TRANSMITTER		CARRIER <sup>(3)</sup>				TIME SIGNALS <sup>(3)</sup>		PERIOD OF OPERATION	
CALL SIGN	CHAIN DESIGNATION <sup>(4)</sup>	APPROXIMATE LOCATION	LONGITUDE LATITUDE	ANTENNA TYPE	CARRIER POWER kW <sup>(5)</sup>	STABILIZED FREQUENCIES kHz	GROUP REPETITION PERIODS (GRP) $\mu$ s	ACCURACY PTS IN $10^6$	TIME PULSES pps	DURATION	METHOD OF ADJUSTMENT	DAYS PER WEEK	HOURS PER DAY
LORAN-C SS7-M	EAST COAST U. S. A.	Caroline Beach, N. C. U. S. A.	+34°03'46"N +77°54'46"W	OMNI-DIRECTIONAL	800	100	99,300	±0.05	YES	CONTINUOUS	1 $\mu$ s STEPS	7	24
LORAN-C SS7-W		Jupiter, FLORIDA U. S. A.	+27°01'59"N +80°06'53"W	OMNI-DIRECTIONAL	400	100							
LORAN-C SS7-X		Cape Race, NEWFOUNDLAND	+46°46'32"N +53°10'29"W	OMNI-DIRECTIONAL	3000	100							
LORAN-C SS7-Y		Nantucket Island U. S. A.	+41°15'12"N +69°58'39"W	OMNI-DIRECTIONAL	400	100							
LORAN-C SS7-Z		Dana, INDIANA U. S. A.	+39°51'08"N +87°29'11"W	OMNI-DIRECTIONAL	400	100							
LORAN-C SL3-M	NORWEGIAN SEA	Ejde, Faroe Is.	+62°17'57"N + 7°04'15"W	OMNI-DIRECTIONAL	400	100	79,700	±0.05	YES	CONTINUOUS	1 $\mu$ s STEPS	7	24
LORAN-C SL3-W		Syllt, GERMANY	+54°48'29"N - 8°17'41"E	OMNI-DIRECTIONAL	300	100							
LORAN-C SL3-X		Bo, NORWAY	+68°38'05"N -14°27'54"E	OMNI-DIRECTIONAL	200	100							
LORAN-C SL3-Y		Sandur, ICELAND	+64°54'31"N +23°55'08"W	OMNI-DIRECTIONAL	3000	100							
LORAN-C SL3-Z		Jan Mayen, NORWAY	+70°54'56"N + 8°43'59"W	OMNI-DIRECTIONAL	200	100							
LORAN-C SH4-M	CENTRAL PACIFIC	Johnston Is.	+ 16°44'44"N +169°20'32"W	OMNI-DIRECTIONAL	300	100	59,600	±0.05	YES	CONTINUOUS	1 $\mu$ s STEPS	7	24
LORAN-C SH4-X		Upolo Pt., HAWAII	+ 20°14'50"N +155°53'09"W	OMNI-DIRECTIONAL	300	100							
LORAN-C SH4-Y		Kure, MIDWAY IS.	+ 28°23'41"N +178°17'30"W	OMNI-DIRECTIONAL	300	100							
LORAN-C SS3-M		Iwo Jima, JAPAN	+ 24°48'04"N -141°19'29"E	OMNI-DIRECTIONAL	4000	100							
LORAN-C SS3-W		Marcus Is.	+ 24°17'08"N -153°58'51"E	OMNI-DIRECTIONAL	4000	100							
LORAN-C SS3-X	NW PACIFIC	Hokkaido, JAPAN	+ 42°44'33"N -143°43'05"E	OMNI-DIRECTIONAL	400	100	99,700	±0.05	YES	CONTINUOUS	1 $\mu$ s STEPS	7	24
LORAN-C SS3-Y		Gesshni, OKINAWA	+ 26°36'27"N -128°08'54"E	OMNI-DIRECTIONAL	400	100							
LORAN-C SS3-Z		Yap CAROLINE IS.	+ 9°32'46"N -138°09'55"E	OMNI-DIRECTIONAL	4000	100							
OMEGA O/N (5)	NIL	Alora, NORWAY	+66°25'N -13°09'E	TOP-LOADED FJORD SPAN	4(ERP) (6)	10.2-A 11-1/3-C 12.2(u) 13.6-(7)	NIL	±0.5	NIL(8)	CONTINUOUS (9)	(3)	7	24
OMEGA O/RD (REPLACES O/N)	NIL	La Moure, N.D., U.S.A.	+46°22'N +98°20'W	TOP-LOADED VERTICAL UMBRELLA	10(ERP)	10.2-D 11-1/3-F 13.6-E 12.85 } (u) 13.1 }	NIL	±0.5	NIL(8)	CONTINUOUS (9)	(3)	7 (ABOUT APRIL 1972)	24
OMEGA O/T	NIL	Trinidad, WEST INDIES	+10°42'N +31°38'W	TOP-LOADED VALLEY-SPAN	1(ERP)	10.2-B 11-1/3-D 12.0(u) 13.6-C	NIL	±0.5	NIL(8)	CONTINUOUS (9)	(3)	7	24
OMEGA O/H	NIL	Haiku, HAWAII U. S. A.	+ 21°24'N +157°50'W	TOP-LOADED VALLEY-SPAN	2(ERP)	10.2-C 11-1/3-E 12.2(u) 13.6-D	NIL	±0.5	NIL(8)	CONTINUOUS (9)	(3)	7	24

- NOTES: (1) INFORMATION OBTAINED AS IN ANNEX B.
- (2) LOCATION OF LORAN-C STATIONS SHOWN IN FIGURE 10.18; OMEGA PROPOSED LOCATIONS ARE SHOWN IN FIGURE 10.16.
- (3) THESE BROADCASTS WILL BE TRANSMITTED WITH ZERO OFFSET AFTER JAN. 1, 1972; OMEGA SYSTEM WILL NOT MAKE LEAP SECOND ADJUSTMENTS.
- (4) THESE LORAN -C CHAINS ARE TIME SYNCHRONIZED AND PHASE CONTROLLED WITHIN ±15 $\mu$ s OF UTC(USNO). (M DESIGNATION INDICATES MASTER; W, X, Y, Z INDICATE SLAVE STATIONS.) FOUR ADDITIONAL CHAINS ARE USED FOR LORAN-C NAVIGATION AND EMPLOY Cs STANDARDS FOR FREQUENCY CONTROL, BUT ARE NOT MAINTAINED WITHIN ±15 $\mu$ s OF UTC. OF THESE, THE MEDITERRANEAN AND NORTH ATLANTIC ARE TIME-MONITORED AND CORRECTIONS IN TERMS OF UTC(USNO) ARE PUBLISHED WEEKLY; THE NORTH PACIFIC (ALASKA) AND SOUTHEAST ASIA ARE UNSYNCHRONIZED AND ARE NOT RELATED TO UTC. THESE LATTER FOUR CHAINS ARE SUBJECT TO TIME JUMPS AND EQUIPMENT FAILURES. SYNCHRONIZATION OF STATIONS WITHIN A CHAIN USUALLY HELD WITHIN ±0.2 $\mu$ s.
- (5) PEAK POWER EXCEPT AS NOTED ESTIMATED RADIATED POWER (ERP).
- (6) EIGHT WORLDWIDE OMEGA NAVIGATION STATIONS ARE PLANNED FOR FULL IMPLEMENTATION IN THE 1970'S. GLOBAL COVERAGE IS ANTICIPATED WITH EACH STATION RADIATING 15 kW OF POWER AT STABILIZED FREQUENCIES BETWEEN 10.2 and 13.6 kHz. FOUR INTERIM STATIONS ARE NOW IN OPERATION AND ARE IN PROCESS OF BEING UPGRADED. ADDITIONAL OMEGA STATIONS WILL BE CONSTRUCTED IN JAPAN, AUSTRALIA-NEW ZEALAND AREA, LA REUNION (INDIAN OCEAN), AND ARGENTINA.
- (7) LETTERS REFER TO SEGMENTS OF OMEGA FORMAT EXCEPT u WHICH INDICATES UNIQUE ASSIGNED FREQUENCY TO GIVEN STATION.
- (8) DAY, h, min, LOW-BIT RATE TIME CODE PROPOSED FOR FUTURE INCLUSION IN OMEGA FORMAT.
- (9) OMEGA FORMAT IS TIME MULTIPLEXED.

## CHAPTER 11

### THE STANDARDS OF TIME AND FREQUENCY IN THE USA\*●

James A. Barnes† and Gernot M. R. Winkler‡

#### Contents

	Page
11.1. Introduction.....	317
11.2. Time Scales – Terms of Reference.....	317
11.2.1. Compromise Time Scales.....	318
11.3. Time and Frequency (T&F) Activities of the National Bureau of Standards and the U.S. Naval Observatory.....	318
11.3.1. The Formal Missions of the T&F Activities of the NBS and USNO.....	318
a. T&F Activities of NBS.....	318
b. The Position of the U.S. Naval Observatory in the Federal Government..	319
(1) The USNO Time Service Division, Background.....	320
(2) Organizations of the USNO Time Service Division.....	320
11.3.2. T&F Activities of NBS and the USNO Compared.....	321
11.3.3. Coordination of T&F.....	322
11.4. International Organizations Involved in Standard Time and Frequency.....	323
11.4.1. Organizations of the Treaty of the Meter (Standards).....	324
11.4.2. Scientific Organizations.....	324
11.4.3. International Radio Consultative Committee (CCIR) (Regulatory).....	324
11.5. The Legal Definition of “Standard Time”.....	325
11.6. Summary.....	325
11.7. References.....	325
Annex 11.A. NBS Enabling Legislation.....	329
Annex 11.B. USNO Authorizing Documents.....	347
Annex 11.C. NBS Time and Frequency Responsibilities.....	359
Annex 11.D. USNO Precise Time and Time Interval (PTTI) Responsibilities.....	363
Annex 11.E. NBS/USNO Time Coordination/Services.....	377
Annex 11.F. Treaty of the Meter.....	385
Annex 11.G. Legal Documents Concerning “Standard Time”.....	389

\*This chapter is a slightly modified version of a paper of the same title presented at the 26th Annual Symposium on Frequency Control (Atlantic City, NJ, June 6-8, 1972).

●Manuscript received February 23, 1973.

†Time and Frequency Division, Institute for Basic Standards, National Bureau of Standards, Boulder, CO 80302.

‡Time Service Division, U.S. Naval Observatory, Washington, D.C. 20390.

"Let us raise a standard to which the wise and honest can repair . . ."

George Washington  
Speech to the Constitutional Convention,  
1787.

This chapter describes the national responsibilities for standards of time and frequency in the U.S.A. The National Bureau of Standards (NBS) and the U.S. Naval Observatory (USNO) are the two organizations chiefly involved in distributing accurate and precise time and frequency information within the USA. The NBS is responsible for the "custody, maintenance, and development of the national standards" of frequency and time (interval) as well as their dissemination to the general public. The mission of the USNO includes the "provision of accurate time" for electronic navigation systems, communication, and space technology. This is an integral part of its work concerned with the publication of ephemerides which are used in support of navigation and in the establishment of a fundamental reference system in space.

Both agencies provide the U.S. contribution to the Bureau International de l'Heure (BIH) [International Time Bureau], which has the responsibility of publishing definitive values of Universal Time (UT), International Atomic Time (TAI), and Coordinated Universal Time (UTC).

**Key words:** Astronomical time measurements; clock synchronization; clocks; Coordinated Universal Time (UTC); frequency; frequency standards; International Atomic Time (TAI); International Radio Consultative Committee (CCIR); International Scientific Radio Union (URSI); International Time Bureau (BIH); international time organizations; leap seconds; national time/frequency standards; NBS time and frequency; Precise Time and Time Interval (PTTI); time; time coordination; time interval; time scales; treaty of the meter (standards); U.S.A. standard time zones; USNO time and frequency.

## 11.1. INTRODUCTION

The national responsibilities for the provision of standards of time and frequency (T&F) in the U.S.A. rests with two organizations of widely different background, professional traditions, and outlook (NBS enabling legislation and USNO authorizing documents (annexes 11.A and 11.B)). The measurement of T&F permeates all scientific observations. It is fundamental to any system of measurement standards, and it is an indispensable element in fundamental astronomy, geodesy, and navigation. It follows from this wide range of applications and interfaces with all disciplines of science and technology that requirements for standards of T&F can only be satisfied in some form of compromise.

A short discussion of principles and terminology, followed by a minimum of historical accounts, will facilitate the review of the present distribution of work and responsibilities of the two agencies involved, the National Bureau of Standards (NBS) and the United States Naval Observatory (USNO). International organizations with time and frequency responsibilities in the areas of standards, scientific groups, and regulatory bodies are described. A brief section outlines the status of the legal definition of "standard time" in the U.S.A. Seven Annexes document various aspects of the contents of this chapter.

## 11.2. TIME SCALES—TERMS OF REFERENCE

A *time scale* is any system which allows the unambiguous ordering of events. Calendars are (rather coarse) time scales. Indeed, the daily movement of the sun, stars, and the moon provides the Time Scale prototype, even though the standard intervals are not *uniform*. Uniformity is a requirement which is becoming increasingly more important for two reasons, one scientific and the other operational. The widespread application of manifestly nonuniform time scales is impractical without corrections which render the scales uniform. Wide applications of time scales require *synchronization* of clocks. Once synchronized, such clocks become the vehicle of access to all kinds of time scales. Thus, the study of synchronization also would be properly said to belong to the broader study of time in general.

As pointed out in Chapter 1, a time scale is a system which allows one to assign "dates" to events, where date refers to some designated mark on a time scale. (Some people use "epoch" for our designation of "date"—see a detailed discussion of these words in chap. 1.) We prefer to use the word "date" if both day and time of day are given for the event. There are many astronomical and clock time scales. The unrestricted word "time" can embody various aspects of time scales, time measurement, as well as time interval or dura-

tion. Thus, one cannot say that "time" is determined solely by astronomical means, since different time scales exist in biology, geology, and physics. On the other hand, the calendar and fraction of a day is the legal standard to which we ultimately refer most events for "dating."

*Clocks* are devices capable of generating and counting time intervals. In order to do this in a most uniform manner, modern atomic clocks derive their frequency (rate) reference from inner atomic processes, shielded as much as possible from external disturbing influences. Such clocks must also contain counters and displays of accumulated time intervals. Since repetitive phenomena are involved here, time, in one way or another, is always identified with angles whether we deal with the rotating earth or with 1-MHz signals from a frequency standard. Our conventional hours, minutes, and seconds are angular measures ("hour angle") of astronomy ("Universal" Time, UT).

In reviewing the historical development of time scales,<sup>1</sup> one becomes aware that, with the rapidity and far-reaching consequences of communication, the greater are the demands for an all-pervasive and unifying convention of synchronizing clocks. That is, it is a matter of convenience and importance that they read the same time, but not necessarily on an absolute time base. An accuracy of a few seconds is perhaps important and sufficient in the operation of railroads. Now, however, sophisticated telecommunications equipment exists which can send and receive several million alphanumeric characters each second; thus, there are accuracy requirements for clock synchronizations to microseconds and better.

Celestial navigators require earth-based time signals to establish their position as determined from the angular orientation of the earth. Since the earth rotates on its axis about once every 24 hours, a navigator can determine his longitude by means of a sextant (which gives him local solar time) and the knowledge of solar time at Greenwich. Approximately 200 years ago the first chronometers were built which allowed the accurate determination of longitude while at sea. Until radio made its appearance, navigation at sea was very dependent upon good clocks. Nowadays, there are many standard time broadcast stations in the world. The best known standard time broadcast stations in North America are operated by the National Bureau of Standards (USA) and the National Research Council (Canada); WWV (NBS) is located in Fort Collins, Colorado; and CHU(NRC) is near Ottawa, Ontario.

Recently, more sophisticated uses of UT have come into being as in geodetic astronomy, star and satellite tracking, and very-long-baseline radio interferometry (VLBI) which require (and can also provide) UT with millisecond accuracy. Since the rotation of the earth is not strictly uniform (varia-

<sup>1</sup> For a more detailed account of time concepts, time scales and uses of time scales, the reader is referred to Chapter 1.

tions in the length of the day are of the order of a part in  $10^8$ ) a problem exists in relation to clock time which can be kept stable to about one part in  $10^{13}$ .

Additional difficulties with clock time arise if used in the prediction of cosmic phenomena as, for example, orbital position of celestial bodies or times of arrival of signals from "pulsars." These latter signals can be resolved today with a precision of better than  $5 \mu\text{s}$  [1]<sup>2</sup>. It is clear that such uses demand a clock time offering more than simply the means for synchronization such as required for electronic system applications.

### 11.2.1. Compromise Time Scales

We have identified very different uses for time. One use allows very high speed and extended electronic systems to function. The needs here are for extremely accurate and/or precise synchronization and measurements of time interval. Another use was for celestial navigation and astronomy. Here the need for precision is less but there are now additional requirements for "epoch" which cannot be set arbitrarily. If Universal Time (UT) could be measured with sufficient accuracy and convenience, the UT could also be used for time systems synchronization. In actuality, Universal Time is difficult to measure, and accuracies at this time are limited to one millisecond (after the fact).

Conflicting requirements imposed on time scales by such varied categories of time scale users provided impetus to form a compromise time scale which would adequately reflect the needs and relative importance of system synchronization as well as navigation and astronomy. With the growing importance and sophistication of communications systems and the implementation of electronic navigation systems (to supplement direct celestial navigation), the trend in the compromise time scales has turned from time scales based solely on the earth's rotation (i.e., astronomical time scales) to those referenced to atomic resonance. In particular, it is quite instructive to explain here briefly the new compromise time scale (called UTC) which became effective internationally on January 1, 1972 [2] (see chap. 1 — ann. 1.B).

As we mentioned previously, the spinning earth does not make a very good clock. In point of fact, commercial atomic clocks in common use today are about one hundred thousand times more uniform than the spinning earth. Nonetheless, navigators need earth time (i.e., earth position relative to the stars) in real time no matter how erratic and unpredictable it might be. We find ourselves in a rather familiar situation. There is not a whole number of days in the year, and we don't want the calendar to get badly out of step with the seasons. Similarly, there is not a whole number of seconds in a solar day, and we don't want our clocks to get

badly out of step with the sun. The solution is analogous to the leap year with its extra day; we have an extra second—a leap second.

In fact, since January 1, 1972, the internationally accepted and used clock time scale can, on occasion, incorporate leap seconds to keep our clocks in approximate step with the sun, thus satisfying the needs of the navigators [3]. In contrast to leap years which occur at defined intervals, the need for leap seconds is not precisely predictable but there should not be more than one in about a year's time. This lack of predictability arises because the earth doesn't spin at a constant rate. In any event leap seconds are going to be with us for a while. They allow a time scale (UTC) running at a constant rate, but whose time still approximates a clock defined by the rotating earth. The compromise time scale, by international agreement, thus provides UTC (atomic) which will be kept within about 700 ms of UT1 (earth), the navigators time scale.

## 11.3. TIME AND FREQUENCY (T&F) ACTIVITIES OF THE NATIONAL BUREAU OF STANDARDS AND THE U.S. NAVAL OBSERVATORY

### 11.3.1. The Formal Missions of T&F Activities of the NBS and USNO

#### a. T&F Activities of NBS

In Title 15 of the United States Code § 272, (see ann. 11.A.1), it states: "Sec. 2." The Secretary of Commerce is authorized to undertake the following functions:

"(a) The custody, maintenance, and development of the national standards of measurement, and the provision of means and methods for making measurements consistent with those standards, including the comparison of standards used in scientific investigations, engineering, manufacturing, commerce, and educational institutions with the standards adopted or recognized by the Government." In particular the authorization specified: "(1) the broadcasting of radio signals of standard frequency" [4]. In Department of Commerce Order, DO 30-2A (June 19, 1972), the above authority is delegated to the Director of the National Bureau of Standards (ann. 11.A.2).

The four independent base units of measurement currently used in science are length, mass, time, and temperature. In certain fields of science such as cosmology, geology, navigation, and astronomy, time interval and (astronomical) date are both important concepts. However, with respect to the fundamental foundations of science, time interval is the most important concept. This is true because the "basic laws" of physics are differential in nature and usually involve small time intervals.

Based on these laws and extensive experimentation, scientists have been able to demonstrate that

<sup>2</sup> Figures in brackets refer to the literature references at the end of this chapter.

frequency can be controlled and measured with the smallest percentage error of any physical quantity. Since most clocks depend on some periodic phenomenon (e.g., a pendulum) in order to “keep time,” and since one can make reliable electronic counters to count the “swings” of the periodic phenomena, we can construct clocks with an elapsed time accuracy of the frequency standard.

In fact, the international definition of the second (unit of time interval) is based on the resonance frequency of the cesium atom. The present definition, approved by the 13th General Conference of Weights and Measures (CGPM) in 1967, states [5]:

“The second is the duration of 9 192 631 770 periods of the radiation corresponding to the transition between the two hyperfine levels of the ground state of the cesium-133 atom.”

The second must therefore be considered as one of the most important base units of the “Système International” (SI), the measurement system used for all scientific and technological measurements [6].

In response to this state of affairs, there is a Time and Frequency Division within the National Bureau of Standards. This Division has 3 major thrusts as shown in figure 11.1.

1) One of these is concerned with basic standards of time and frequency. Presently, it consists of two program areas; i.e., Quantum Electronic Frequency Standards and Atomic Time Standards. Their prime responsibilities are shown in figure 11.1. Principally, they are engaged in research and development of both primary and backup frequency standards, and associated time scales [7, 8], innovation of state-of-art T&F processes [9, 10], and operation of the NBS primary standards of frequency and time interval. (Their work is documented also in many chapters of this Monograph.)

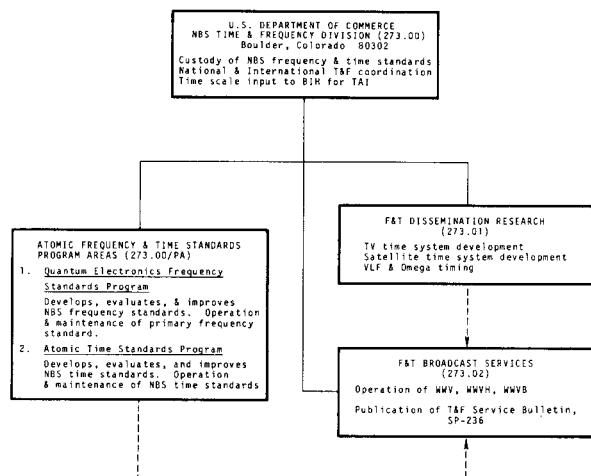

FIGURE 11.1. The Time and Frequency Division of the NBS.

2) The Frequency and Time Dissemination Research Group conducts research and development activities on new methods of disseminating time and frequency information. As examples, this Section developed the TV line-10 synchronization pulse technique [11] based on the work of Tolman et al. [12]; devised and perfected a more extensive TV time system [13, 14] which actively encodes time signals in the vertical interval; and developed some satellite timing techniques [15, 16].

3) The Frequency and Time Broadcast Services Group disseminates the NBS standard frequencies and time scales via radio (WWV, WWVH, and WWVB), and via telephone (303-499-7111). More detailed information about these services may be obtained by requesting *NBS Special Publication 236* [17] from:

Frequency and Time Broadcast  
Services Section, 273.02  
National Bureau of Standards  
Boulder, Colorado 80302.

This section also publishes a monthly Bulletin giving NBS time scale information, phase deviations of standard frequency transmissions, and TV and satellite information (see ann. 11.E.4).

All of the activities of these groups are coordinated both nationally and internationally through the Time and Frequency Division Office. In a formal sense, the mission of the Division and the individual Sections and Program Areas are summarized in Annex 11.C. This Annex also includes a brief description of postdoctoral research associateships assigned to the Division with the cooperation of the National Research Council.

#### b. The Position of the U.S. Naval Observatory in the Federal Government

The U.S. Naval Observatory performs the same public functions as the national observatories of the principal countries of the world. Its nearest counterparts are the Royal Greenwich Observatory (United Kingdom), the Pulkovo Observatory (USSR), and the Paris Observatory (France). It is the sole authority in the United States for astronomical data required for public and legal purposes, such as times of sunrise and sunset, moonrise and moonset, and almanacs required for marine and air navigation, and for land surveying [18, 19].

By virtue of its official mission,<sup>3</sup> the primary function of the U.S. Naval Observatory is to provide accurate time and other astronomical data which are essential for safe navigation at sea, in the air, and in space. To carry out this function, it is necessary for the Observatory to maintain continual observations of the positions and motions of the

<sup>3</sup> “Make such observations of celestial bodies, natural and artificial, derive and publish such data as will afford to United States Naval vessels and aircraft as well as to all availing themselves thereof, means for safe navigation, including the provision of accurate time, and while pursuing this primary function, contribute material to the general advancement of navigation and astronomy” [20] (see ann. 11.B.3).

sun, moon, planets, and principal stars. From some of these observations astronomical time is determined.

The determination and dissemination of precise clock time, which the Observatory has developed to very high precision, is essential to many military operations, especially the fields of electronic navigation, communications, and space technology. In response to these needs, the Department of Defense has charged the USNO with single management responsibilities for T&F in the Department of Defense [21] (see ann. 11.D). The Naval Observatory also concentrates on astrometry (precise measurements of angular distances between celestial objects), celestial mechanics (theories and calculations of the motions of celestial bodies), and astrophysics. It operates the most modern and precise special-purpose astronomical equipment in the world, most of which has been designed by its staff, and is comprised of about 20 telescopes of various kinds at its stations in Washington D.C., Arizona, Florida, in the U.S.A. and Argentina [22].

The Observatory is also a computing center and publishing house, calculating and publishing each year 1,000 pages of navigational data, 500 pages of astronomical predictions, and averaging 250 pages of research papers, all of which are published in book form, as well as numerous research papers in astronomical periodicals.

**(1) The USNO Time Service Division, Background**

There has been a continuous evolution from the first public "time service," the dropping of the USNO time ball at noon (1844), to the many services rendered today (ann. 11.E.). Many of these services and operations were the first of their kind; for example:

1) In 1904 the first worldwide radio time signals were broadcast from a U.S. Navy station based on a clock provided and controlled by the Observatory.

2) A "Photographic Zenith Tube" (PZT) has been used by the Observatory since 1915 for the determination of latitude and since 1933 for the determination of latitude and Universal Time (UT).

3) The "Dual Rate Moon Camera" was invented by William Markowitz in 1951, and it became the instrument with which the frequency of cesium (which today is the basis for the definition of the second) was determined with respect to the ephemeris second. This assured a clock rate which allows the use of atomic time (A.1 and now TAI) as an extrapolation of ephemeris time [23].

4) The first atomic time scale (A.1) using the value for the cesium frequency (later adopted internationally) also applied the principle of an "average clock" [24]. Originally, A.1 was determined from all available cesium clocks throughout the world.

The USNO clock time scale is still derived from a set of "standard" clocks (selected commercial cesium standards). In contrast, the NBS atomic

time scale is based on a laboratory cesium standard and a set of commercial cesium standards which serve as a memory of the rate of the primary standard. Only USNO clocks are used today for the USNO clock time reference [25, 26]. There are also other substantial differences in basic philosophy between NBS and USNO which may be resolved only after much more experience becomes available [27].

**(2) Organizations of USNO Time Service Division**

There are four sections within this Division as shown in figure 11.2:

1) Control of Time/Time Interval Section. This section is responsible for all electronics support and instruments. It monitors T&F transmissions of United States Naval electronic systems and other precise T&F transmissions (WWVL, GBR, foreign time signals, etc.) and prepares control messages to stations controlled directly by the USNO. It prepares Time Service Announcements, Series 2, 3, 4, 5, 8, 9, and 16 (see ann. 11.E.5).

2) Precise Time Operations Section. This section is responsible for external liaison and portable clock operations used for national and international coordination. It carries the main load of PTTI management responsibilities as assigned by the Department of Defense Directive [21].

3) Astronomy—Washington, DC. This section is responsible for observations with the PZT, Astrolabe and Moon Camera in Washington. It is responsible for all computer software including automatic data acquisition and control system, and is responsible for the atomic clock time scale under direct supervision of the Assistant Director.

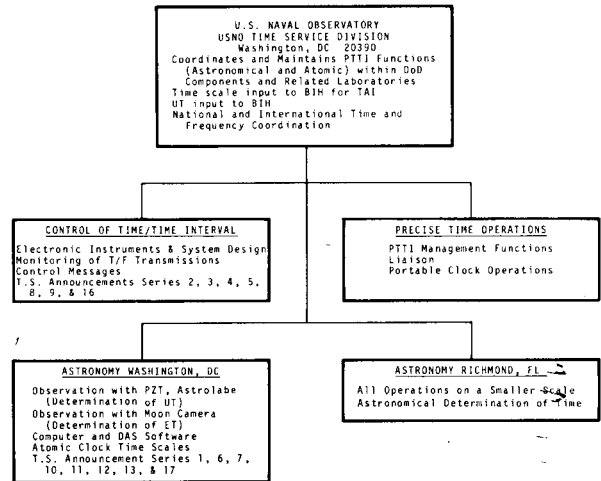

FIGURE 11.2. The USNO Time Service Division.



It is also responsible for Time Service Announcements, Series, 1, 6, 7, 10, 11, 12, 13, and 17 (see ann. 11.E.5).

4) Astronomy—Richmond, Florida (near Miami). This is a largely independent Observatory capable of all Washington time operations on a smaller scale. It is a station with one of the most favorable climatic conditions anywhere (320 clear nights per year, compared to 210 at Washington, DC). In addition, background radio noise is low, and this makes the station valuable as a monitor site.

The above listed activities produce only part of the information which is published daily, weekly, monthly, and irregularly by the USNO Time Service Division (see ann. 11.E). A great number of messages and notes are received regularly from cooperating stations all over the world whose contributions make it possible to achieve today a truly "worldwide continuity of precision" in time measurements with which the USNO is specifically charged [21]. In addition, the USNO initiates annual PTTI meetings for T&F specialists to consider new and improved techniques in the field [28].

### 11.3.2. T&F Activities of NBS and USNO Compared

As listed in the previous section, the main interactions of the two agencies can be summarized as shown in figure 11.3. Both agencies provide input to the BIH (at the Paris Observatory) which is charged to provide a central international reference point for time and related matters. NBS and USNO are both substantial contributors to the International Atomic Time Scale, TAI, constructed by the BIH and now serving as reference for UTC. NBS provides input in regard to absolute accuracy of the

rate of TAI (and the U.S. clock time scales as well). USNO provides UTO and latitude information.

In conformance with the specific mission statements, as cited above, *time* and *absolute frequency* are central but not exclusive areas of concern, competence, and responsibility of the USNO and NBS respectively. Both areas are very closely linked, which requires equally close cooperation between the two agencies (see ann. 11.E.3). For example, the NBS broadcasts of standard frequency have as a most logical extension a 24-hour standard time signal emission. Commensurate with the NBS introduction of these and similar services (a TV and a satellite T&F dissemination are being actively investigated by NBS), the USNO has reduced or eliminated some of its own dissemination services. Today, the Naval time signals are on the air for only 5 minute periods every 1, 2, or more hours (but on about 30 frequencies) [29]. They are intended to supplement the WWV and WWVH emissions. These HF services of NBS are very important to the USNO and its "customers" (navigators, geodesists, astronomers, etc.).

It is noteworthy that table 11.1, which summarizes the main points of this discussion, represents only an historical ideal. Clock coordination has diminished the direct significance of USNO's role as a national time standard since the UTC(NBS)—UTC(USNO) time difference is less than  $6 \mu\text{s}$  since June 1968 [30] and since both agencies provide independent clock time input to the BIH. On the other hand, the real standard of frequency is now the cesium atom and there is no longer a U.S. frequency standard (or a U.S. second) just as there is no U.S. meter. However, there is U.S. input to the absolute SI second from a primary frequency standard at the NBS.

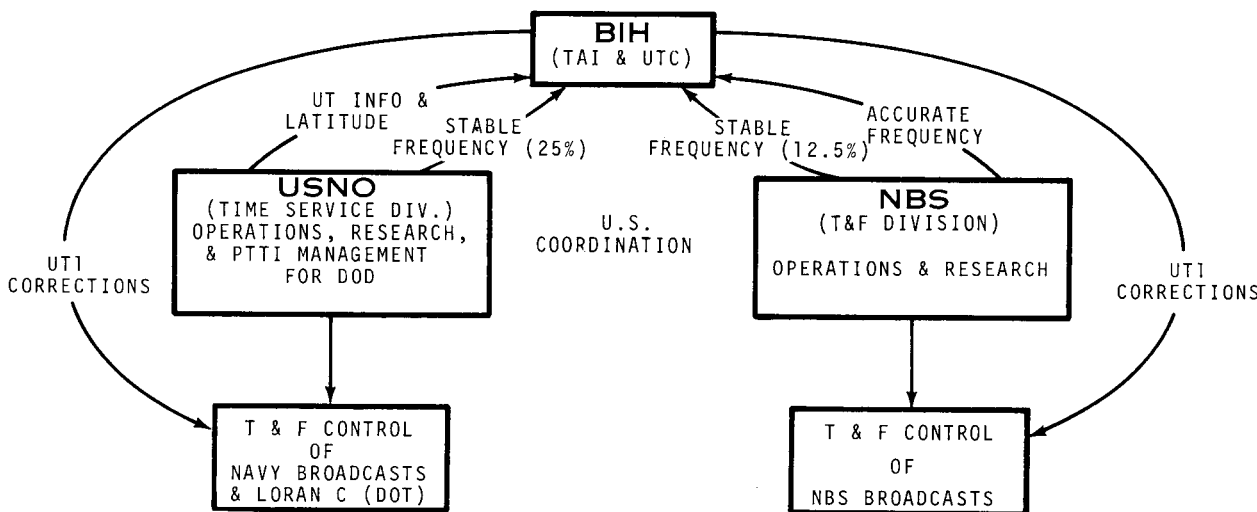

FIGURE 11.3. NBS, USNO, and BIH interactions.

TABLE 11.1. T&F Responsibilities of NBS/USNO

NBS	USNO
<i>National Standard of Frequency; Standard Frequency (and Time) Broadcast; Fundamental Research in T&amp;F as related to Clock Time and Frequency Measurements, Synchronization; Consultation and Education; USNO Precise Time Reference Station.</i>	<i>National Standard of Time (Epoch, Date); Control of Naval T&amp;F Transmissions; Applied Research in Time as related to Clock applica- tions, Astronomy, Geophysics, Navigation; Consultation and Management of PTI activities as related to DOD.</i>

### 11.3.3. Coordination of T&F

Each agency, NBS and USNO, derives an entirely independent local atomic time scale: AT(NBS) and A.1(USNO). AT(NBS) is based on (occasional) calibrations of its operational standards (8 commercial cesium clocks) with the NBS primary frequency standard. A.1(USNO) is based on a set of 16 best commercial cesium clocks selected as "standards" from about 70 cesium clocks available to the USNO. A.1(USNO) results from an adjusted, iterated averaging procedure which makes the average rate of the time scale independent of the particular clocks used and assures very great reliability.

Both of these inputs are used by the BIH to compute the TAI and UTC scales.

The agencies' *coordinated* clocks are derived with a deliberate coordination offset ( $\leq 10^{12}$ ). The International Radio Consultative Committee (CCIR) and the International Astronomical Union (IAU) recommend 1 ms as the maximum tolerance [2, 31]. As noted previously, UTC(NBS) and UTC(USNO) have been closer than  $6\mu s$  since 1968; also they are now within a few microseconds of UTC(BIH). It is the intent to achieve even closer coordination in the future. Figure 11.4 depicts the coordination of time scales within the USA with input to the BIH (see ann. 11.E).

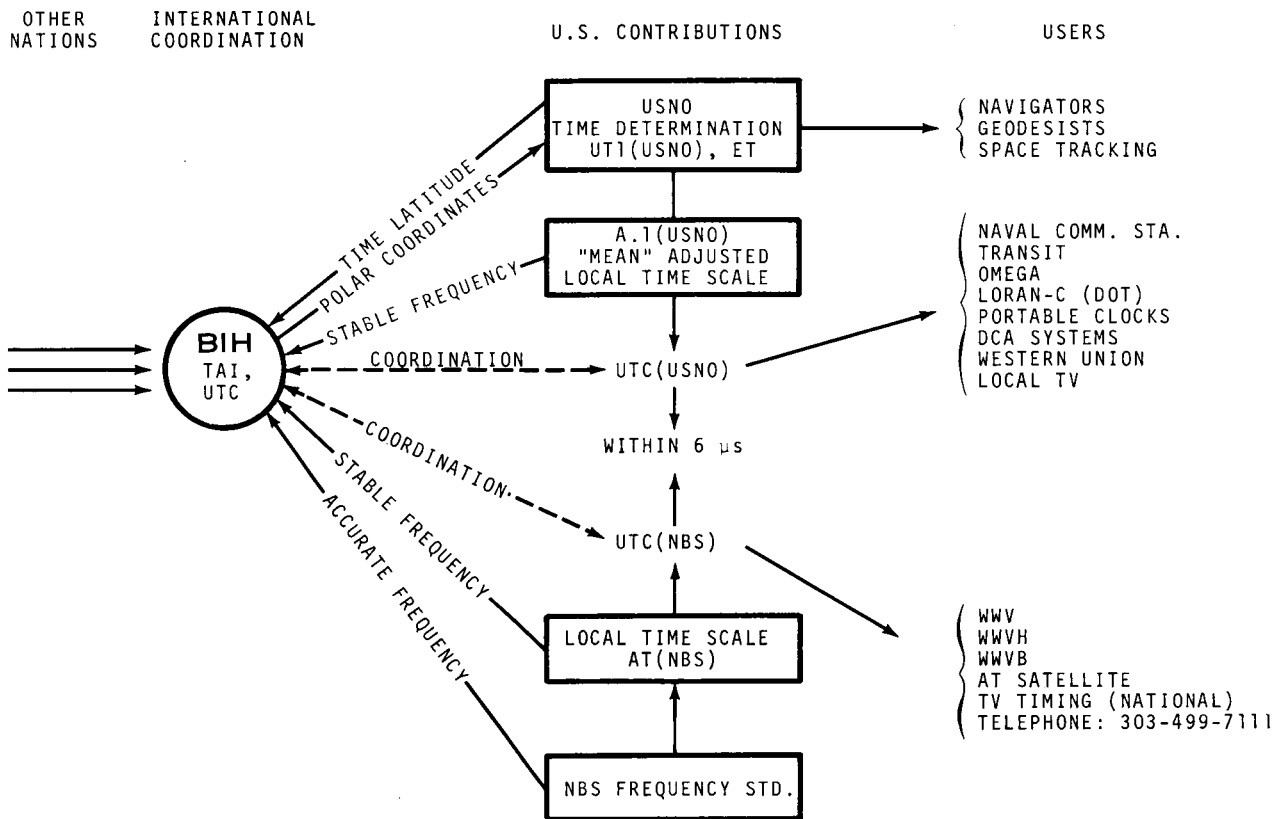

FIGURE 11.4. Time scales in the United States of America.

In addition to clock time, UT1 and the coordinates of the pole are furnished internationally by the BIH[32] and in the USA by the USNO[33]. (The pole coordinates are given at various times and at the three levels of "Predicted," "Preliminary" (BIH "Rapid Service"), and "Final.") In view of the fact that the BIH values are averages of some 50 observatories, its values are precise to better than 1 ms in UT1 and about 0".01 in  $x$  and  $y$  (polar coordinates). The results of the International Latitude Service (ILS, now IPMS) can be considered more accurate but less precise than BIH in the polar coordinates since the definition of the Standard Pole (OCI) refers to the 5 latitude stations and not to the BIH observatories [34]. With the increase of participating observatories, the relative importance of these U.S. contributions has decreased. We can expect similar developments with respect to the U.S. local atomic time scales as more national timekeeping agencies contribute to the TAI.

#### 11.4. INTERNATIONAL ORGANIZATIONS INVOLVED IN STANDARD TIME AND FREQUENCY

The general subject of time and frequency is important in three fundamentally different ways. Firstly, it is important as one of the 4 independent base units in metrology (i.e., length, mass, time, and temperature); that is, it is important to the Système International (SI) of units of measurement. Secondly, time and frequency are important scientifically in their own right, not just as they influence measurements; and thirdly the methods of dissemination of standard time and frequency are important from a regulatory aspect such as the assignment of radio spectrum for broadcast purposes of standard time and frequency. Correspondingly, one can find three separate chains of international involvement with time and frequency as shown in figure 11.5; i.e., standards, scientific, and regulatory.

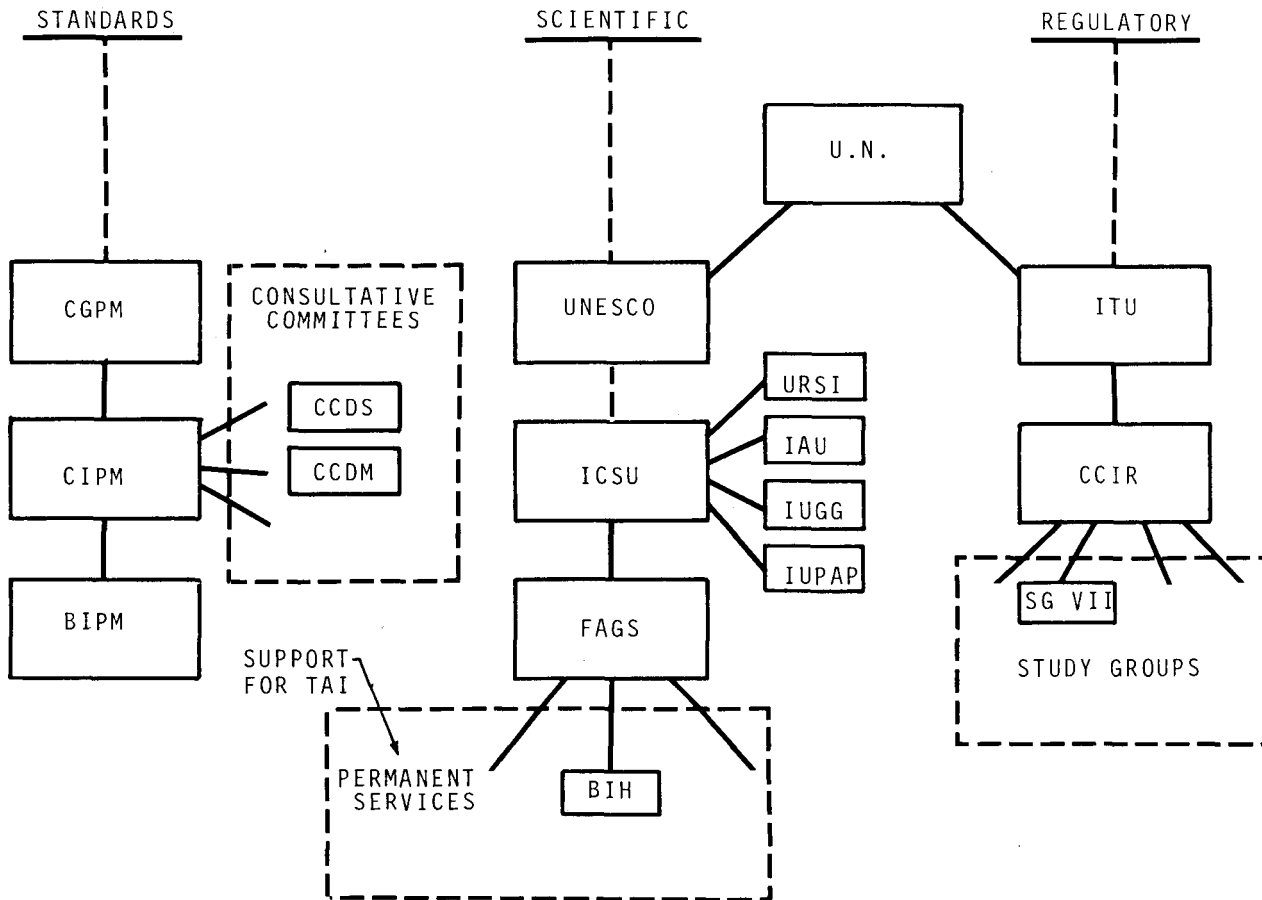

FIGURE 11.5. International organizations involved with standard frequency and time.

### 11.4.1. Organizations of the Treaty of the Meter (Standards)

The USA was one of the original signers of the Treaty of the Meter in 1875 [35] (see ann. 11.F). This treaty established an international standards laboratory (Bureau International des Poids et Mesures, BIPM) which is governed by an international committee (Comité International des Poids et Mesures, CIPM) composed of representatives of the member nations. Advisory to the CIPM are various technical consultative committees (e.g., the Consultative Committee for the Definition of the Second (CCDS), the Consultative Committee for the Definition of the Meter (CCDM), etc.). Policy decisions such as financial assessments of the member nations and final endorsements of new definitions of standards are handled by a General Conference of Weights and Measures (CGPM).

### 11.4.2. Scientific Organizations

Scientific involvement occurs through the International Council of Scientific Unions (ICSU) which receives support and financial assistance from the United Nations Educational, Scientific, and Cultural Organization (UNESCO). Also, in our area, there are four scientific unions (see table 11.2 for abbreviations): URSI, IAU, IUPAP, and IUGG. Within these scientific unions, T & F matters are primarily confined to URSI-Commission 1 and IAU-Commission 31.

ICSU has established a number of permanent services administered by the Federation of Astronomical and Geophysical Services (FAGS). These

permanent services include the Bureau International de l'Heure (BIH), the International Polar Motion Service (IPMS), and others. Historically, the BIH has had the responsibility of coordinating and calculating the final and formally adopted measurements of time. With the advent of atomic clocks and with the recommendations of the IAU, the BIH established its own atomic time scale (TAI) which is based, ultimately, on a weighted average of various local atomic time scales [36]. The CGPM has endorsed the TAI scale for defining International Atomic Time (date) [37], and the CGPM will also provide some financial assistance to the BIH (see chap. 1—ann. 1.A.3).

### 11.4.3. International Radio Consultative Committee (CCIR) (Regulatory)

Advisory to the International Telecommunications Union (ITU) is the CCIR with its numerous Study Groups. Study Group 7 of the CCIR is concerned with standard frequency and time broadcasts. The recommendations of CCIR specify the acceptable formats for standard frequency and time broadcasts as well as the tolerances of the broadcast scales relative to the time scales of the BIH [2]. Although these recommendations do not have the force of international law, almost all countries carefully adhere to them (see chap. 1—ann. 1.B).

For each of the international organizations cited above there exist either national delegates or national committees which formulate the national policy to be presented to the international organizations.

TABLE 11.2. *Abbreviations of International Organizations*

Abbreviation	Organization
BIH.....	International Bureau of Time.
BIPM.....	International Bureau of Weights and Measures.
CCDM.....	Consultative Committee for the Definition of the Meter.
CCDS.....	Consultative Committee for the Definition of the Second.
CCIR.....	International Radio Consultative Committee.
CGPM.....	General Conference of Weights and Measures.
CIPM.....	International Committee of Weights and Measures.
FAGS.....	Federation of Astronomical and Geophysical Services.
IAU.....	International Astronomical Union.
ICSU.....	International Council of Scientific Unions.
ITU.....	International Telecommunications Union.
IUGG.....	International Union of Geodesy and Geophysics.
IUPAP.....	International Union of Pure and Applied Physics.
UN.....	United Nations.
UNESCO.....	United Nations Educational, Scientific, and Cultural Organization.
URSI.....	International Science Radio Union.

## 11.5. THE LEGAL DEFINITION OF "STANDARD TIME"

The legal basis of Standard Time in the USA is contained in the "Uniform Time Act of 1966" (Public Law 89-387) [38] and the U.S. Code, Title 15 [39] (see ann. 11.G). This act reiterates the policy of the United States to "promote the adoption and observance of uniform time within prescribed Standard Time Zones . . ." and establishes the annual advancement and retardation of standard time by 1 hour the last Sunday of April and October respectively. The Department of Transportation (DOT) is the agency designated for enforcement of the law.

The "Uniform Time Act" establishes 8 Standard Time Zones for the USA (see fig. 11.6) and notes that Standard Time is based on the mean solar time of specified longitudes. The reference meridians are spaced  $15^\circ$  apart in longitude beginning with the meridian through Greenwich, England. Time zones extend  $7\frac{1}{2}^\circ$  in longitude on each side with considerable variation in boundaries to conform to political and/or geographic boundaries. Since the time zones are  $15^\circ$  apart, the time difference between two adjacent zones is one hour. Mean solar time (related to UTC and not UT1) is simply apparent solar time, corrected for the effects of orbital eccentricity and the tilt of the earth's axis relative to the ecliptic plane; i.e. corrected by the equation of time.

The 8 USA Standard Time Zones are designated as follows:

- 1) Atlantic Standard Time
- 2) Eastern Standard Time
- 3) Central Standard Time
- 4) Mountain Standard Time
- 5) Pacific Standard Time
- 6) Yukon Standard Time
- 7) Alaska-Hawaii Standard Time
- 8) Bering Standard Time.

A comprehensive delineation of these zones is given in the *Code of Federal Regulations*, entitled "Standard Time Zone Boundaries" (see ann. 11.G.3). This code indicates also the various exceptions and time zones for the operating railroads within the USA.

## 11.6. SUMMARY

Time and Frequency is a complex field with widely different requirements. Historically, two agencies have provided the standards of time and frequency in the USA; they are the USNO and the NBS, respectively. Their roles have evolved, however, into more diversified interests. The need to coordinate with the rest of the world and the new "natural" standards of time (the second) and length (the meter) produce a strong pressure for adjustment in the interest of improving our public

services. This, together with the different professional backgrounds of the two agencies, has emphasized different thrusts of action. Operations and worldwide organization of resources have always been favored by astronomers, particularly those who use clocks as a means and not as an end.

On the other hand, questions of absolute accuracy in the realization of a measurement standard, research in the physics of clocks, and education in the use of standards is emphasized at NBS. Both agencies conduct research which is complementary rather than competitive not only because management wants it, but because of their different professional outlook and resources.

## 11.7. References

- [1] Allan, D. W., "Time transfer using near-synchronous reception of optical pulsar signals," *Proc. IEEE (Lett.)*, **60**, No. 5, pp. 625-627 (May 1972).
- [2] CCIR, "Detailed instructions by Study Group 7 for the implementation of Recommendation 460 concerning the improved coordinated universal time (UTC) system, valid from 1 January 1972," in *XIIIth Plenary Assembly CCIR, III*, pp. 258 a-d (ITU, Geneva, Switzerland, 1970) (see chap. 1-ann. 1.B.1).
- [3] Smith, H. M., "International time and frequency coordination," *Proc. IEEE*, **60**, No. 5, pp. 479-487 (May 1972).
- [4] Committee on Judiciary of House of Representatives, *United States Code: 1970 Edition*, Title 15, **3**, Chapter 7, "The National Bureau of Standards," sec. 271-290, pp. 3231-3240 (USGPO, 1971).
- [5] CGPM, *Comptes Rendus des Séances de la Treizième Conférence Général des poids et Mesures* (Proceedings of the Sessions of the 13th General Conference of Weights and Measures) (Paris, France, October 1968), p. 103 (Gauthier-Villars, Paris, France, 1968) (in French—see chap. 1-ann. 1.A.1).
- [6] Page, C. H., and Vigoureux, P. (Editors), "The International System of Units," (American translation of "Le Système International d'Unités") 1970 OFFILB, 48 rue Gay-Lussac, F. 75, Paris 5 (Revised Edition 1972), *Nat. Bur. Stand. (U.S.) Spec. Publ. 330*, 1972 Ed., p. 3 (USGPO, April 1972).
- [7] Brandenberger, H., Hadorn, F., Halford, D., and Shoaf, J. H., "High quality quartz crystal oscillators: frequency domain and time domain stability," *Proc. 25th Ann. Symp. on Frequency Control* (U.S. Army Electronics Command, Ft. Monmouth, NJ 07703, April 26-28, 1971), pp. 226-230 (NTIS, AD 746211, 1971).
- [8] Allan, D. W., "Statistical modeling and filtering for optimum atomic time scale generator," *Proceedings of the Frequency Standards and Metrology Seminar* (Quebec, Canada, August 30, 31-September 1, 1971), pp. 388-410 (Quantum Electronics Lab., Dept. of Elect. Eng., Laval University, Quebec, Canada, 1972).
- [9] Halford, D., Hellwig, H., and Wells, J. S., "Progress and feasibility for a unified standard for frequency, time, and length," *Proc. IEEE (Lett.)*, **60**, No. 5, pp. 623-625 (May 1972).
- [10] Hellwig, H. (Ed.), *Proceedings of the Frequency Standards and Metrology Seminar*, (Quebec, Canada, August 30, 31-September 1, 1971) (Quantum Electronics Lab., Dept. of Elect. Eng., Laval University, Quebec, Canada, 1972).
- [11] Davis, D. D., Blair, B. E., and Barnaba, J., "Long-term continental U.S. timing system via TV networks," *IEEE Spectrum*, **8**, No. 8, pp. 41-52 (August 1971).
- [12] Tolman, J., Ptáček, V., Souček, A., and Stecher, R., "Microsecond clock comparison by means of TV synchronizing pulses," *IEEE Trans. on Instrum. and Meas.*, **IM-16**, No. 3, pp. 247-254 (September 1967).
- [13] Davis, D. D., Jespersen, J. L., and Kamas, G., "The use of television signals for time and frequency dissemination," *Proc. IEEE (Lett.)*, **58**, No. 6, pp. 931-933 (June 1970).

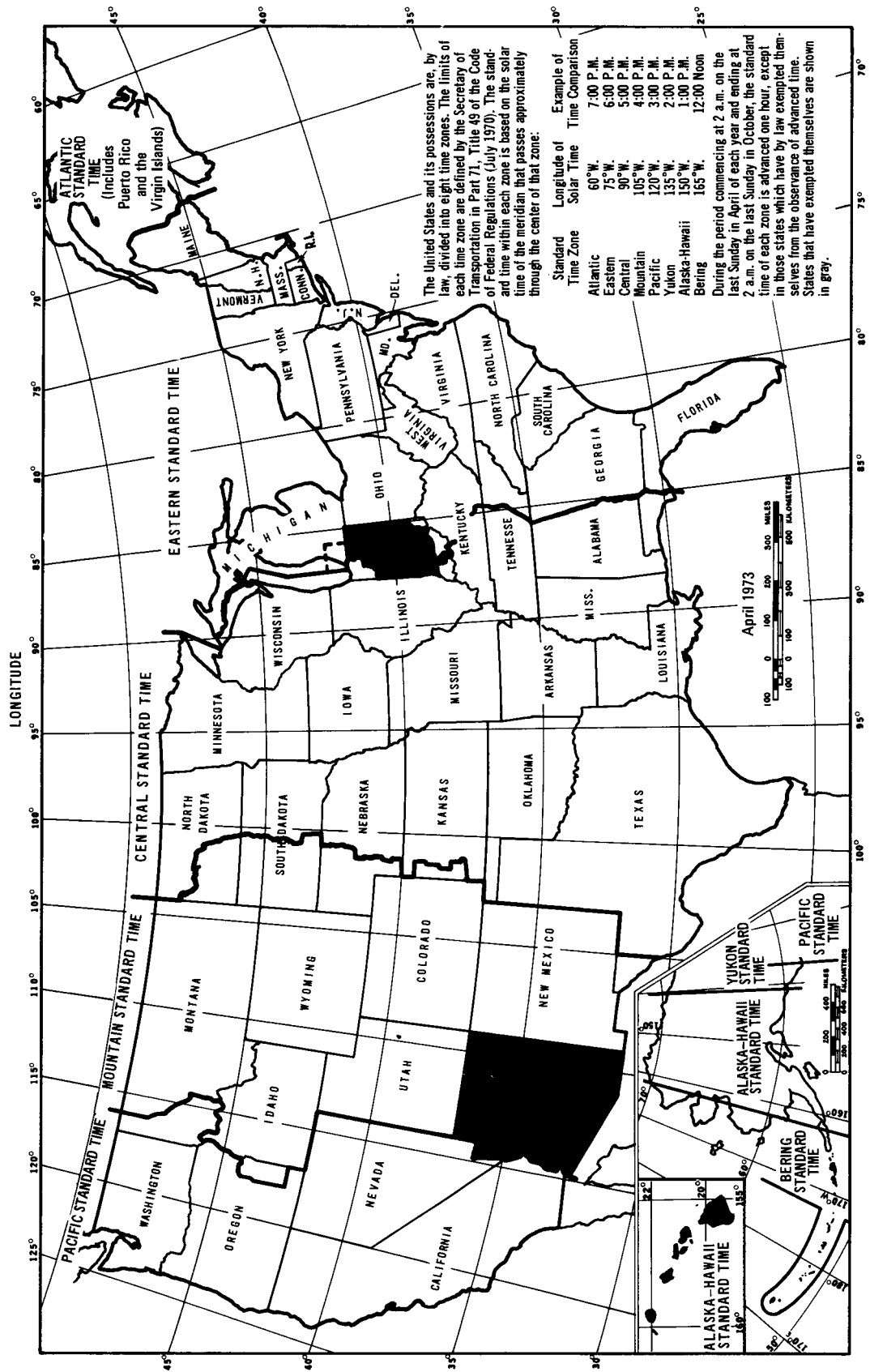

FIGURE 11.6. Standard Time Zones of the United States of America.

- [14] Howe, D. A., "Nationwide precise time and frequency distribution utilizing an active code within network television broadcasts," *IEEE Trans. on Instrum. and Meas.*, **IM-21**, No. 3, pp. 263-276 (August 1972).
- [15] Hanson, D. W., and Hamilton, W. F., "Clock synchronization from satellite tracking," *IEEE Trans. on Aerosp. and Electron. Syst.*, **AES-7**, No. 5, pp. 895-899 (September 1971).
- [16] Hanson, D. W., Hamilton, W. F., and Gatterer, L. E., "The NBS frequency and time satellite experiment using ATS-3," *Proc. 3rd Ann. Precise Time and Time Interval (PTTI) Strategic Planning Meeting* (November 16-18, 1971) (U.S. Naval Observatory, Washington, DC 20390), pp. 155-165 (USNO, Washington, DC 20390, 1972 (NTIS, AD 758739)).
- [17] Viezbicke, P. P. (Ed.), "NBS frequency and time broadcast services," *Nat. Bur. Stand. (U.S.) Spec. Publ. 236*, 1972 Ed., 14 pages (USGPO, March 1972) (Updated annually).
- [18] USNO/HMSO, *The Nautical Almanac for the Year 1973* (Issued jointly by Nautical Almanac Office/USNO-USA and H-M's Nautical Office/RGO-United Kingdom) 276 pages and Annexes (USGPO, 1971).
- [19] USNO/HMSO, *The Air Almanac-1973 (January-April)* (Issued jointly by Nautical Almanac Office/USNO-USA and H-M's Nautical Office/RGO-United Kingdom) 276 pages and Annexes (USGPO, 1971).
- [20] U.S. Navy/CNO, "Mission and functions of the U.S. Naval Observatory," *U.S. Naval Operations Instruct. 5450.90B*, 1 page (December 16, 1969) (see ann. 11.B.3).
- [21] U.S. Department of Defense (DOD), "Precise time and time interval (PTTI) standards and calibration facilities for use by Department of Defense Components," *DOD Directive No. 5160.51*, 6 pages (August 31, 1971); also *Code of Federal Regulations (CFR)*, Title 32 (National Defense), Chap. 1, "Part 275-Precise time and time interval (PTTI) standards and calibration facilities for use by Department of Defense components," pp. 550-552 (USGPO, January 1, 1972). (NOTE: The CFR essentially codifies agency regulations and should not be confused with the United States Code (USC) which codifies legal statutes, Presidential Orders, etc.) (see ann. 11.D.1).
- [22] USNO, *United States Naval Observatory*, 18 pages (USNO, Washington, DC 20390, 1972).
- [23] Markowitz, W., Hall, R. G., Essen, L., and Parry, J. V. L., "Frequency of cesium in terms of ephemeris time," *Phys. Rev. Letters*, **1**, pp. 105-106 (August 1962).
- [24] Markowitz, W., "The atomic time scale," *IRE Trans. on Instrum.*, **I-11**, Nos. 3 and 4, pp. 239-242 (December 1962).
- [25] Winkler, G. M. R., Hall, R. G., and Percival, D. B., "The U.S. Naval Observatory clock time reference and the performance of a sample of atomic clocks," *Metrologia*, **6**, No. 4, pp. 126-134 (October 1970).
- [26] Putkovich, K., "Automated timekeeping," *Trans. on Instrum. and Meas.*, **IM-21**, No. 4, pp. 401-405 (November 1972).
- [27] Allan, D. W., and Gray, J. E., "Comments on the October 1970 Metrologia paper, 'The U.S. Naval Observatory clock time reference and the performance of a sample of atomic clocks,'" *Metrologia*, **7**, No. 2, pp. 79-82 (April 1971).
- [28] USNO/NASA, *Proc. 4th Ann. NASA and DOD Precise Time and Time Interval (PTTI) Meet.* (NASA Goddard Space Flight Center, Greenbelt, MD 20771, November 14-16, 1972), 371 pages (NASA, X-814-73-72, Greenbelt, MD 20771, 1973).
- [29] USNO, "Worldwide primary VLF and HF transmissions," *Time Service Announcement*, Series 1, No. 1, 20 pages (USNO, Washington, DC 20390, July 1971).
- [30] NBS, "Nation gets unified time system," *Nat. Bur. Stand. (U.S.) Tech. News Bull.*, **53**, No. 2, p. 34 (USGPO, February 1969).
- [31] De Jager, C., and Jappel, A., (Editors), "Commission 31: Time (l'Heure)-Session 4" (Proc. 14th General Assembly, Brighton, England 1970) *Trans. IAU, XIV B*, p. 198 (D. Reidel Publishing Co., Dordrecht, Holland, 1971).
- [32] BIH, *Monthly Circulars B, C, and D and Annual Reports* (BIH, Paris, France).
- [33] USNO, *Time Service Announcements*, Series 7 and 11 (USNO, Washington, DC 20390).
- [34] Mueller, I. I., *Spherical and Practical Astronomy*, pp. 80-84 (Frederick Ungar Publishing Co., New York, NY 10003, 1969).
- [35] Schwarz, K. M., *Federal and State Weights and Measures Laws*, "Metric Convention-1875," *Nat. Bur. Stand. (U.S.) Circular 501*, pp. 3-5 (USGPO, December 1951) (see ann. 11.F).
- [36] Guinot, B., Feissel, M., and Granveaud, M., *Bureau International d l'Heure Annual Report for 1971*, pp. A9-A20 (BIH, Paris, France, 1972).
- [37] CGPM, *Comptes Rendus des Séances de la Quatorzième Conférence Générale des poids et Mesures* (Proceedings of the Session of the 14th General Conference of Weights and Measures) (Paris, France, October 4-8, 1971), pp. 77-78 (BIPM, Sevres, France, 1972) (See chap. 1-ann. 1.A.3).
- [38] USA, "Uniform Time Act of 1966," *Public Law 89-387, 89th Congress, S. 1404*, 3 pages (USGPO, April 13, 1966) (see ann. 11.G.1).
- [39] Committee on Judiciary of House of Representatives, *United States Code: 1970 Edition*, Title 15, **3**, Chap. 6, "Weights and Measures and Standard Time," sec. 260-267, pp. 3228-3231 (USGPO, 1971) (see ann. 11.G.2).
- [40] NBS/NRC, "Postdoctoral research associateships-1973 tenable at National Bureau of Standards (Washington, DC and Boulder, CO)," in association with the National Research Council, pp. 31-32 (NRC, Washington, DC 20418, 1972).
- [41] Fizell, W. E., "On the determination of universal time and the use of the U.S. Naval Observatory Time Service Bulletins, Notices, and Announcements," *NASA Report X-521-70-188*, 28 pages (NTIS, N70 41890, 1970).

**Annex 11.A.**  
**NBS ENABLING LEGISLATION**

**Contents**

	Page
11.A.1. NBS Legislative Authority—U.S. Department of Commerce, Nat. Bur. Stand. (U.S.) Ad. Man. Chapter 1. April 30, 1968 (sec. 1.01.01 to 1.01.10). [See <i>U.S. Code</i> , Title 15, <b>3</b> , Chap. 7, sec. 271–290. pp. 3231–3240, 1970 Edition (USGPO, 1971)].....	331
11.A.2. U.S. Department of Commerce— <i>Department Organization Order 30–2A</i> —National Bureau of Standards Mission Statements, 4 pages, June 19, 1972.....	335
11.A.3. U.S. Department of Commerce— <i>Department Organization Order 30–2B</i> —National Bureau of Standards Mission Statements, 8 pages, June 12, 1972.....	339



# ANNEX 11.A.1.

U. S. DEPARTMENT OF COMMERCE NATIONAL BUREAU OF STANDARDS  <b>ADMINISTRATIVE MANUAL</b>	Chapter 1	Authority
	Subchapter 1	Legislative Authority

## LEGISLATIVE AUTHORITY

### Sections

- 1.01.01 Basic Legislation
- 1.01.02 Bureau Established
- 1.01.03 Functions of Secretary
- 1.01.04 Functions: For Whom Exercised
- 1.01.05 Director: Powers and Duties
- 1.01.06 Appointment of Officers and Employees
- 1.01.07 Service Charges
- 1.01.08 Ownership of Facilities
- 1.01.09 Regulations
- 1.01.10 Visiting Committee
- 1.01.11 Gifts and Bequests
- 1.01.12 Working Capital Fund
- 1.01.13 Acquisition of Land for Field Sites
- 1.01.14 Construction and Improvement of Buildings and Facilities
- 1.01.15 Functions and Activities
- 1.01.16 Fire Research and Safety
- 1.01.17 Multiyear Appropriation Authority
- 1.01.18 Testing Materials for District of Columbia
- 1.01.19 National Hydraulic Laboratory
- 1.01.20 Other Legislation
  - a. Standards of Electrical and Photometric Measurement
  - b. Research Associates

#### 1.01.01

##### BASIC LEGISLATION

The National Bureau of Standards was established on March 3, 1901, by "An Act to Establish the National Bureau of Standards" (31 Stat. 1449). Extensive amendments were made in 1950 by passage of Public Law 81-619 (64 Stat. 371); in 1956 by Public Law 84-940 (70 Stat. 959); and in 1958 by Public Law 85-890 (72 Stat. 1711). The provisions of the organic act and amendments are merged in the following statement of basic legislation quoted from Title 15 of the United States Code.

#### 1.01.02

##### BUREAU ESTABLISHED

(15 U.S.C. 271)  
"The Office of Standard Weights and Measures shall be known as the National Bureau of Standards."

#### 1.01.03

##### FUNCTIONS OF SECRETARY

(15 U.S.C. 272)  
"The Secretary of Commerce (hereinafter referred to as the "Secretary") is authorized to undertake the following functions:

November 28, 1972  
(Trans. 181)

1.01.01 - 1.01.03

"(a) The custody, maintenance, and development of the national standards of measurement, and the provision of means and methods for making measurements consistent with those standards, including the comparison of standards used in scientific investigations, engineering, manufacturing, commerce, and educational institutions with the standards adopted or recognized by the Government.

"(b) The determination of physical constants and properties of materials when such data are of great importance to scientific or manufacturing interests and are not to be obtained of sufficient accuracy elsewhere.

"(c) The development of methods for testing materials, mechanisms, and structures, and the testing of materials, supplies, and equipment, including items purchased for use of Government departments and independent establishments.

"(d) Cooperation with other governmental agencies and with private organizations in the establishment of standard practices, incorporated in codes and specifications.

"(e) Advisory service to Government agencies on scientific and technical problems.

"(f) Invention and development of devices to serve special needs of the Government.

"In carrying out the functions enumerated in this section, the Secretary is authorized to undertake the following activities and similar ones for which need may arise in the operations of Government agencies, scientific institutions, and industrial enterprises:

"(1) the construction of physical standards;

"(2) the testing, calibration, and certification of standards and standard measuring apparatus;

"(3) the study and improvement of instruments and methods of measurements;

"(4) the investigation and testing of railroad track scales, elevator scales, and other scales used in weighing commodities for interstate shipment;

"(5) cooperation with the States in securing uniformity in weights and measures laws and methods of inspection;

"(6) the preparation and distribution of standard samples such as those used in checking chemical analyses, temperature, color, viscosity, heat of combustion, and other basic properties of materials; also the preparation and sale or other distribution of standard instruments, apparatus and materials for calibration of measuring equipment;

"(7) the development of methods of chemical analysis and synthesis of materials, and the investigation of the properties of rare substances;

"(8) the study of methods of producing and of measuring high and low temperatures; and the behavior of materials at high and at low temperatures;

"(9) the investigation of radiation, radioactive substances, and X-rays, their uses, and means of protection of persons from their harmful effects;

"(10) the study of the atomic and molecular structure of the chemical elements, with particular reference to the characteristics of the spectra emitted, the use of spectral observations in determining chemical composition of materials, and the relation of molecular structure to the practical usefulness of materials;

"(11) the broadcasting of radio signals of standard frequency;

"(12) the investigation of the conditions which affect the transmission of radio waves from their source to a receiver;

"(13) the compilation and distribution of information on such transmission of radio waves as a basis for choice of frequencies to be used in radio operations;

"(14) The study of new technical processes and methods of fabrication of materials in which the Government has a special interest; also the study of methods of measurement and technical processes used in the manufacture of optical glass and pottery, brick, tile, terra cotta, and other clay products;

"(15) the determination of properties of building materials and structural elements, and encouragement of their standardization and most effective use, including investigation of fire-resisting properties of building materials and conditions under which they may be most efficiently used, and the standardization of types of appliances for fire prevention;

"(16) metallurgical research, including study of alloy steels and light metal alloys; investigation of foundry practice, casting, rolling, and forging; prevention of corrosion of metals and alloys; behavior of bearing metals; and development of standards for metals and sands;

"(17) the operation of a laboratory of applied mathematics;

"(18) the prosecution of such research in engineering, mathematics, and the physical sciences as may be necessary to obtain basic data pertinent to the functions specified herein; and

"(19) the compilation and publication of general scientific and technical data resulting from the performance of the functions specified herein or from other sources when such data are of importance to scientific or manufacturing interests or to the general public, and are not available elsewhere, including demonstration of the results of the Bureau's work by exhibits or otherwise as may be deemed

most effective, and including the use of National Bureau of Standards scientific or technical personnel for part-time or intermittent teaching and training activities at educational institutions of higher learning as part of and incidental to their official duties and without additional compensation other than that provided by law."

#### 1.01.04

##### FUNCTIONS: FOR WHOM EXERCISED (15 U.S.C. 273)

"The Bureau is authorized to exercise its functions for the Government of the United States and for international organizations of which the United States is a member; for governments of friendly countries; for any State or municipal government within the United States; or for any scientific society, educational institution, firm, corporation, or individual within the United States or friendly countries engaged in manufacturing or other pursuits requiring the use of standards or standard measuring instruments: Provided, That the exercise of these functions for international organizations, governments of friendly countries and scientific societies, educational institutions, firms, corporations, or individuals therein shall be in coordination with other agencies of the United States Government, in particular the Department of State in respect to foreign entities. All requests for the services of the Bureau shall be made in accordance with the rules and regulations established in sections 276 and 277 of this title (15 U.S.C.)."

#### 1.01.05

##### DIRECTOR: POWERS AND DUTIES (15 U.S.C. 274)

"The director shall be appointed by the President, by and with the advice and consent of the Senate. He shall have the general supervision of the bureau, its equipment, and the exercise of its functions. He shall make an annual report to the Secretary of Commerce, including an abstract of the work done during the year and a financial statement. He may issue, when necessary, bulletins for public distribution, containing such information as may be of value to the public or facilitate the bureau in the exercise of its functions."

## 1.01.06

APPOINTMENT OF OFFICERS AND EMPLOYEES  
(15 U.S.C. 275)

"The officers and employees of the bureau, except the director, shall be appointed by the Secretary of Commerce at such time as their respective services may become necessary."

to be attained in standards submitted for verification, the sealing of standards, the disbursement and receipt of moneys, and such other matters as he may deem necessary for carrying into effect sections 271-278b of this title [15 U.S.C.]"

## 1.01.07

SERVICE CHARGES  
(15 U.S.C. 275a)

"The Secretary shall charge for services performed under the authority of section 273 of this title, [15 U.S.C.] except in cases where he determines that the interest of the Government would be best served by waiving the charge. Such charges may be based upon fixed prices or costs. The appropriation or fund bearing the cost of the services may be reimbursed, or the Secretary may require advance payment subject to such adjustment on completion of the work as may be agreed upon."

## 1.01.10

VISITING COMMITTEE  
(15 U.S.C. 278)

"There shall be a visiting committee of five members to be appointed by the Secretary of Commerce, to consist of men prominent in the various interests involved, and not in the employ of the Government. This committee shall visit the bureau at least once a year, and report to the Secretary of Commerce upon the efficiency of its scientific work and the condition of its equipment. The members of this committee shall serve without compensation, but shall be paid the actual expenses incurred in attending its meetings. The period of service of the members of the committee shall be so arranged that one member shall retire each year, and the appointments to be for a period of five years. Appointments made to fill vacancies occurring other than in the regular manner are to be made of the remainder of the period in which the vacancy exists."

## 1.01.08

OWNERSHIP OF FACILITIES  
(15 U.S.C. 276)

"In the absence of specific agreement to the contrary, additional facilities, including equipment, purchased pursuant to the performance of services authorized by section 273 of this title [15 U.S.C.] shall be come the property of the Department of Commerce."

## 1.01.09

REGULATIONS  
(15 U.S.C. 277)

"The Secretary of Commerce shall, from time to time, make regulations regarding the payment of fees, the limits of tolerance

**ANNEX 11.A.2.**

TRANSMITTAL 126

<b>United States of America DEPARTMENT OF COMMERCE</b>	<b>DEPARTMENT ORGANIZATION ORDER <u>30-2A</u></b>	
<b>DEPARTMENT ORGANIZATION ORDER SERIES</b>	<b>DATE OF ISSUANCE</b>  June 19, 1972	<b>EFFECTIVE DATE</b>  June 19, 1972
<b>SUBJECT</b>  NATIONAL BUREAU OF STANDARDS		
<p><u>SECTION 1. PURPOSE.</u></p> <p>This order delegates authority to the Director of the National Bureau of Standards, and prescribes the functions of the National Bureau of Standards.</p> <p><u>SECTION 2. STATUS AND LINE OF AUTHORITY.</u></p> <p>.01 The National Bureau of Standards, established by Act of March 3, 1901, (31 Stat. 1449 15 U.S.C. 271) is continued as a primary operating unit of the Department of Commerce.</p> <p>.02 The Director, who is appointed by the President by and with the advice and consent of the Senate, shall be the head of the Bureau. The Director shall report and be responsible to the Assistant Secretary for Science and Technology.</p> <p>.03 The Director shall be assisted by a Deputy Director, who shall be the principal assistant to the Director and shall perform the functions of the Director during the latter's absence or disability. He shall also serve as Acting Director whenever the position of Director is vacant, unless and until the Secretary shall make a further designation. In the absence of both the Director and Deputy Director, an employee of the Bureau designated in writing by the Director shall act as Director.</p> <p><u>SECTION 3. DELEGATION OF AUTHORITY.</u></p> <p>.01 Pursuant to authority vested in the Secretary of Commerce by law (including Reorganization Plans No. 3 of 1946, No. 5 of 1950, and No. 2 of 1965), and subject to such policies and directives as the Secretary of Commerce or the Assistant Secretary for Science and Technology may prescribe, the Director is hereby delegated the authority to perform the functions vested in the Secretary of Commerce by the following Chapters of Title 15, United States Code:</p> <ul style="list-style-type: none"> <li>a. Chapter 6 (Weights and Measures);</li> <li>b. Chapter 7 (The Bureau of Standards, except for subsections 272(f) 12 and 13, which pertain to the investigation of the conditions which affect the transmission of radio waves, and the compilation and distribution of information on such transmission, which activities have been delegated to the Office of Telecommunications.);</li> <li>c. Chapter 25 (Flammable Fabrics);</li> <li>d. Chapter 26 (Household Refrigerators); and</li> <li>e. Chapter 39 (Fair Packaging and Labeling).</li> </ul> <p>.02 The above delegations of authority are subject to the following limitations:</p> <ul style="list-style-type: none"> <li>a. The Director may issue such regulations as he considers necessary to carry out his responsibilities, except that procedural regulations pertaining to the formulation, adoption, or publication of voluntary or mandatory product standards, as provided for or authorized by Chapters 7, 25, 26, and 39 of Title 15, U.S. Code, are to be issued by the Assistant Secretary for Science and Technology.</li> </ul>		

b. With respect to Chapter 25 of Title 15, U.S. Code, the authorities to adopt final flammability standards, to appoint members of, and deal with, the National Advisory Committee for the Flammable Fabrics Act, and to transmit an annual report of the results of the Department's activities in carrying out the Flammable Fabrics Act, as amended, are reserved to the Secretary. The authority to make determinations of possible need for, and to institute proceedings for the determination of, a flammability standard or other regulation is delegated to the Assistant Secretary for Science and Technology.

c. The authority to prescribe and publish commercial standards, pursuant to Section 1213, Chapter 26, Title 15, U.S. Code, is reserved to the Secretary.

d. With respect to Chapter 39 of Title 15, U.S. Code, the authority delegated in this order excludes the authority to make determinations of (1) an undue proliferation of weights, measures, or quantities, pursuant to 15 U.S.C. 1454 (d), and (2) the non-adoption of standards or the non-observance of adopted standards, pursuant to 15 U.S.C. 1454 (e), which authority is delegated to the Assistant Secretary for Science and Technology. The authorities to submit reports to the Congress concerning non-adoption or failure to observe voluntary product standards, pursuant to 15 U.S.C. 1454 (e), and to transmit an annual report to the Congress, as required by 15 U.S.C. 1457, are reserved to the Secretary.

.03 The Director is further delegated the authority to perform the functions assigned to the Secretary by Section 759(f), Chapter 16, Title 40, United States Code, pertaining to the conduct of research and the provision of scientific and technological advisory services relating to automatic data processing (ADP) and related systems, except that recommendations to the President concerning the establishment of uniform Federal ADP standards are reserved to the Secretary.

.04 The Director is further delegated the authority to perform the functions vested in the Secretary by:

a. Public Law 90-396 (82 Stat. 339), called the Standard Reference Data Act; and

b. Public Law 85-934 (72 Stat. 1793; 42 U.S.C. 1891-3) to make grants for the support of basic scientific research to nonprofit institutions of higher education and to nonprofit organizations whose primary purpose is the conduct of scientific research.

.05 Pursuant to the authority delegated to the Secretary by the Administrator of the General Services Administration (Temporary Regulation E-10, July 11, 1967, Federal Property Management Regulations), and subject to such policies and directives as the Secretary or the Assistant Secretary for Science and Technology may prescribe, the Director is hereby delegated authority to operate an automatic data processing service center.

.06 The authority delegated to the Secretary by the Administrator of the General Services Administration, dated August 15, 1967, (32 F.R. 11969), to appoint uniformed guards as special policemen and to make all needful rules and regulations for the protection of those parcels of property at National Bureau of Standards installations which are not protected by GSA guards, and over which the Federal Government has exclusive or concurrent jurisdiction, is hereby redelegated to the Director. This authority shall be exercised in accordance with the requirements of the Federal Property and Administrative Services Act of 1949 (63 Stat. 377), as amended, and the Act of June 1, 1948 (62 Stat. 281), as amended, and policies, procedures, and controls of the General Services Administration.

.07 The authority vested in the Secretary of Commerce, by Executive Order 11654, dated March 13, 1972, which pertains to the Federal Fire Council, is hereby delegated to the Director. This delegation shall include authority to serve as Chairman of the Council or to designate an employee of the National Bureau of Standards to serve in that capacity.

.08 The Director may exercise other authorities of the Secretary as applicable to performing the functions assigned in this order.

.09 The Director may redelegate his authority to any employee of the National Bureau of Standards subject to such conditions in the exercise of such authority as he may prescribe.

SECTION 4. FUNCTIONS.

.01 The National Bureau of Standards shall perform the following functions:

- a. Develop and maintain the national standards of measurement, and provide means for making measurements consistent with those standards;
- b. Determine the physical constants and properties of materials;
- c. Develop methods for testing materials, mechanisms, and structures, and conduct such tests thereof as may be necessary, with particular reference to the needs of Government agencies;
- d. Cooperate with and assist industry, business, consumers, and governmental organizations in the establishment, technical review, determination of acceptability, and publication of voluntary standards, recommended specifications, standard practices, and model codes and ordinances;
- e. Provide advisory service to Government agencies on scientific and technical problems;
- f. Conduct a program for the collection, compilation, critical evaluation, publication, and dissemination of standard reference data;
- g. Invent and develop devices to serve special scientific and technological needs of the Government;
- h. Conduct programs, in cooperation with United States business groups and standards organizations, for the development of international standards of practice;
- i. Conduct a program of research, investigation, and training with respect to the flammability characteristics of textiles and fabrics;
- j. Conduct research and provide technical services designed to improve the effectiveness of use by the Federal Government of computers and related techniques;
- k. Conduct a national fire research and safety program, (as provided for by Public Law 90-259 (82 Stat. 34-39) amending Chapter 7 of Title 15, United States Code);
- l. Conduct a program to provide an experimental basis for formulation of Government policy to stimulate the development and use of technology by industry; and
- m. Coordinate the activities of the Federal Fire Council.

.02 The Bureau shall perform the following functions, pursuant to the Fair Packaging and Labeling Act (Chapter 39, Title 15, United States Code):

- a. Ascertain the number and other characteristics of the weights, measures, and quantities in which commodities are packaged for retail sale;
- b. Conduct studies of the relationship between the weights, measures, and quantities in which commodities are packaged and the ability of consumers to make value comparisons;
- c. Conduct studies concerning the extent to which voluntary product standards adopted pursuant to 15 U.S.C. 1454 are being followed by industry;

d. Distribute copies of regulations and standards promulgated under this chapter, and provide information and assistance to appropriate State officials, to promote uniformity in State and Federal regulation of the labeling of consumer commodities; and,

e. Conduct such other studies, investigations, and standards development activities as are necessary to achieve the objectives of the Act.

.03 The Bureau, as appropriate, shall request the views of, and provide an opportunity for participation by, the Bureau of Domestic Commerce in the development and execution of its responsibilities for conducting investigations and analyses, and for developing or appraising product standards, under the Flammable Fabrics Act, the Fair Packaging and Labeling Act, or other Bureau legislative authorities.

SECTION 5. EFFECT ON OTHER ORDERS.

This order supersedes Department Organization Order 30-2A of October 1, 1968 (formerly DO 90-A), as amended.

  
Secretary of Commerce



United States of America DEPARTMENT OF COMMERCE	DEPARTMENT ORGANIZATION ORDER 30-2B	
DEPARTMENT ORGANIZATION ORDER SERIES	DATE OF ISSUANCE June 12, 1972	EFFECTIVE DATE June 12, 1972 <i>and 1</i> <i>and 2</i>
SUBJECT NATIONAL BUREAU OF STANDARDS		
<p><u>SECTION 1. PURPOSE.</u></p> <p>This order prescribes the organization and assignment of functions within the National Bureau of Standards (NBS). This revision establishes a Center for Building Technology under the Institute for Applied Technology, (paragraph 11.11) and makes certain other changes of a minor nature.</p> <p><u>SECTION 2. ORGANIZATION.</u></p> <p>The organization structure and line of authority of the National Bureau of Standards shall be as depicted in the attached organization chart.</p> <p><u>SECTION 3. OFFICE OF THE DIRECTOR.</u></p> <p>.01 The <u>Director</u> determines the policies of the Bureau and directs the development and execution of its programs.</p> <p>.02 The <u>Deputy Director</u> assists the Director in the direction of the Bureau and performs the functions of the Director in the latter's absence.</p> <p><u>SECTION 4. STAFF UNITS REPORTING TO THE DIRECTOR.</u></p> <p>.01 The <u>Office of Academic Liaison</u> shall serve as the focal point for the Bureau's cooperation with the academic institutions, and serve as liaison office for cooperative research activities between the Bureau and other Government agencies.</p> <p>.02 The <u>Office of Legal Adviser</u> shall, under the professional supervision of the Department's General Counsel and as provided in Department Organization Order 10-6, serve as the law office of and have responsibility for all legal services at the National Bureau of Standards.</p> <p><u>SECTION 5. OFFICE OF THE ASSOCIATE DIRECTOR FOR PROGRAMS.</u></p> <p>The <u>Office of the Associate Director for Programs</u> shall perform the functions of policy development, program analysis, and program promotion; sponsor and coordinate the performance of issue and impact studies; relate Bureau programs to national needs; generate planning formats and develop information on NBS program plans and status for internal and external audiences; administer evaluation panels; and define alternatives for the allocation of resources and advise Bureau management on their implications.</p> <p><u>SECTION 6. OFFICE OF THE ASSOCIATE DIRECTOR FOR ADMINISTRATION.</u></p> <p>.01 The <u>Associate Director for Administration</u> shall be the principal assistant and adviser to the Director on management matters and is responsible for the conduct of administrative management functions, including the management of NBS buildings, plants, and non-scientific facilities. He shall carry out these responsibilities primarily through the organization units specified below, which are under his direction.</p> <p>.02 The <u>Accounting Division</u> shall administer the official system of central fiscal records, payments and reports, and provide staff assistance on accounting and related matters.</p>		

.03 The Administrative Services Division shall be responsible for security, safety, emergency planning, and civil defense activities; provide mail, messenger, communications, duplicating, and related office services; manage use of auditorium and conference rooms; conduct records and forms management programs; operate an NBS records holding area; manage the NBS motor vehicle fleet; and provide janitorial service.

.04 The Budget Division shall provide advice and assistance to line management in the preparation, review, presentation, and management of the Bureau's budget encompassing its total financial resources.

.05 The Personnel Division shall advise on personnel policy and utilization; administer recruitment, placement, classification, employee development and employee relations activities; and assist operating officials on these and other aspects of personnel management.

.06 The Plant Division shall maintain the physical plant at Gaithersburg, Maryland, and perform staff work in planning and providing grounds, buildings, and improvements at other Bureau locations.

.07 The Supply Division shall procure and distribute material, equipment, and supplies purchased by the Bureau, keep records and promote effective utilization of property, act as the Bureau coordinating office for research, construction, supply and lease contracts of the Bureau, and administer telephone communications services and travel services.

.08 The Management and Organization Division shall provide consultative services to line management in organization, procedures, and management practices; develop administrative information systems; maintain the directives system; and perform reports management functions.

.09 The Instrument Shops Division shall design, construct, and repair precision scientific instruments and auxiliary equipment.

#### SECTION 7. OFFICE OF THE ASSOCIATE DIRECTOR FOR INFORMATION PROGRAMS.

.01 The Associate Director for information Programs shall promote optimum dissemination and accessibility of scientific information generated within NBS and other agencies of the Federal Government; promote the development of the National Standard Reference Data System and a system of information analysis centers dealing with the broader aspects of the National Measurement System; provide appropriate services to ensure that the NBS staff has optimum accessibility to the scientific information of the world; and direct public information activities of the Bureau.

.02 The Office of Standard Reference Data shall administer the National Standard Reference Data System which provides critically evaluated data in the physical sciences on a national basis. This requires arrangement for the continuing systematic review of the national and international scientific literature in the physical sciences, the evaluation of the data it contains, the stimulation of research needed to fill important gaps in the data, and the compilation and dissemination of evaluated data through a variety of publication and reference services tailored to user needs in science and industry.

.03 The Office of Technical Information and Publications shall foster the outward communication of the Bureau's scientific findings and related technical data to science and industry through reports, articles, conferences and meetings, films, correspondence and other appropriate mechanisms; and assist in the preparation, scheduling, printing and distribution of Bureau publications.

.04 The Library Division shall furnish diversified information services to the staff of the Bureau, including conventional library services, bibliographic, reference, and translation services; and serve as a reference and distribution center for Congressional legislative materials and issuances of other agencies.

.05 The Office of International Relations shall serve as the focal point for Bureau activities in the area of international scientific exchanges.

SECTION 8. CENTER FOR COMPUTER SCIENCES AND TECHNOLOGY.

.01 The Center for Computer Sciences and Technology shall conduct research and provide technical services designed to aid Government agencies in improving cost effectiveness in the conduct of their programs through the selection, acquisition, and effective utilization of automatic data processing equipment (Public Law 89-306); and serve as the principal focus within the executive branch for the development of Federal standards for automatic data processing equipment, techniques, and computer languages.

.02 The Director shall direct the development, execution, and evaluation of the programs of the Center.

.03 The functions of the organizational units of the Center are as follows:

a. The Office of Information Processing Standards shall provide leadership and coordination for Government efforts in the development of information processing standards at the Federal, national, and international levels.

b. The Office of Computer Information shall function as a specialized information center for computer sciences and technology.

c. The Computer Services Division shall provide computing and data conversion services to NBS and other agencies on a reimbursable basis; and provide supporting problem analysis and computer programming as required.

d. The Systems Development Division shall conduct research in information sciences and computer programming; develop advanced concepts for the design and implementation of data processing systems; and provide consultative services to other agencies in software aspects of the design and implementation of data processing systems.

e. The Information Processing Technology Division shall conduct research and development in selected areas of information processing technology and related disciplines to improve methodologies and to match developing needs with new or improved techniques and tools.

SECTION 9. INSTITUTE FOR BASIC STANDARDS.

.01 The Institute for Basic Standards shall provide the central basis within the United States of a complete and consistent system of physical measurement; coordinate that system with measurement systems of other nations; and furnish essential services leading to accurate and uniform physical measurements throughout the Nation's scientific community, industry, and commerce.

.02 The Office of the Director.

a. The Director shall direct the development, execution, and evaluation of the programs of the Institute.

b. The Deputy Director shall assist in the direction of the institute and perform the functions of the Director in the latter's absence.

c. The Deputy Director, Institute for Basic Standards/Boulder shall assist in the direction of the Institute's programs at Boulder and report to the Associate Director for Administration through the Director, IBS, in supervising the administrative divisions at Boulder.

d. The administrative divisions reporting to the Deputy Director, Institute for Basic Standards/Boulder include:

Supply Services Division  
 Instrument Shops Division  
 Plant Division

These divisions and units within his office shall provide staff support for the technical program and administrative services for the NBS organization at Boulder, Colorado. The administrative units and divisions shall also service, as needed, National Oceanic and Atmospheric Administration and Office of Telecommunications units at Boulder, Colorado, and associated field stations.

.03 The Office of Measurement Services shall coordinate the Bureau's measurement services program, including development and dissemination of uniform policies on Bureau calibration practices.

.04 The Center for Radiation Research shall constitute a prime resource within the Bureau for the application of radiation, not only to Bureau mission problems, but also to those of other agencies and other institutions. The resulting multipurpose and collaborative functions reinforce the capability of the Center for response to Bureau mission problems.

a. The Director shall report to the Director, Institute for Basic Standards, and shall direct the development, execution, and evaluation of the programs of the Center. The Deputy Director shall assist in the direction of the Center and perform the functions of the Director in the absence of the latter.

b. The organizational units of the Center for Radiation Research are as follows:

Linac Radiation Division  
 Nuclear Radiation Division  
 Applied Radiation Division

Each of these Divisions shall engage in research, measurement, and application of radiation to the solution of Bureau and other institutional problems, primarily through collaboration.

.05 The other organization units of the Institute for Basic Standards are as follows:

Located at Bureau Hdqrs.

Applied Mathematics Division  
 Electricity Division  
 Mechanics Division  
 Heat Division  
 Optical Physics Division

Located at Boulder, Colorado

Quantum Electronics Division  
 Electromagnetics Division  
 Time and Frequency Division  
 Laboratory Astrophysics Division  
 Cryogenics Division

a. Each Division except the Applied Mathematics Division shall engage in such of the following functions as are appropriate to the subject matter field of the Division:

1. Develop and maintain the national standards for physical measurement, develop appropriate multiples and sub-multiples of prototype standards, and develop transfer standards and standard instruments;
2. Determine important fundamental physical constants which may serve as reference standards, and analyze the self-consistencies of their measured values;
3. Conduct experimental and theoretical studies of fundamental physical phenomena of interest to scientists and engineers with the general objective of improving or creating new measurement methods and standards to meet existing or anticipated needs;

4. Conduct general research and development on basic measurement techniques and instrumentation, including research on the interaction of basic measuring processes on the properties of matter and physical and chemical processes;
  5. Calibrate instruments in terms of the national standards, and provide other measurement services to promote accuracy and uniformity of physical measurements;
  6. Correlate with other nations the national standards and definitions of the units of measurement; and
  7. Provide advisory services to Government, science, and industry on basic measurement problems.
- b. The Applied Mathematics Division shall conduct research in various fields of mathematics important to physical and engineering sciences, automatic data processing, and operations research, with emphasis on statistical, numerical and combinatorial analysis and systems dynamics; provide consultative services to the Bureau and other Federal agencies; and develop and advise on the use of mathematical tools, in checking mathematical tables, handbooks, manuals, mathematical models, and computational methods.

SECTION 10. INSTITUTE FOR MATERIALS RESEARCH.

.01 The Institute for Materials Research shall conduct materials research leading to improved methods of measurement, standards, and data on the properties of materials needed by industry, commerce, educational institutions, and Government; provide advisory and research services to other Government agencies; and develop, produce, and distribute standard reference materials.

.02 The Director shall direct the development, execution and evaluation of the programs of the Institute. The Deputy Director shall assist in the direction of the Institute and perform the functions of the Director in the latter's absence.

.03 The Office of Standard Reference Materials shall evaluate the requirements of science and industry for carefully characterized reference materials which provide a basis for calibration of instruments and equipment, comparison of measurements and materials, and aid in the control of production processes in industry; and stimulate the Bureau's efforts to develop methods for production of needed reference materials and direct their production and distribution.

.04 The other organization units of the Institute for Materials Research are as follows:

- Analytical Chemistry Division
- Polymers Division
- Metallurgy Division
- Inorganic Materials Division
- Reactor Radiation Division
- Physical Chemistry Division

Each Division shall engage in such of the following functions as are appropriate to the subject matter field of the Division:

- a. Conduct research on the chemical and physical constants, constitution, structure, and properties of matter and materials;
- b. Devise and improve methods for the preparation, purification, analysis, and characterization of materials;
- c. Investigate fundamental chemical and physical phenomena related to materials of importance to science and industry, such as fatigue and fracture, crystal growth and imperfections, stress, corrosion, etc.;

- d. Develop techniques for measurement of the properties of materials under carefully controlled conditions including extremes of high and low temperature and pressure and exposure to different types of radiation and environmental conditions;
- e. Assist in the development of standard methods of measurement and equipment for evaluating the properties of materials;
- f. Conduct research and development methodology leading to the production of standard reference materials, and produce these materials;
- g. Provide advisory services to Government, industry, universities, and the scientific and technological community on problems related to materials;
- h. Assist industry and national standards organizations in the development and establishment of standards; and
- i. Cooperate with and assist national and international organizations engaged in the development of international standards.

#### SECTION 11. INSTITUTE FOR APPLIED TECHNOLOGY.

.01 The Institute for Applied Technology shall provide technical services to promote the use of available technology and to facilitate technological innovation in industry and Government; cooperate with public and private organizations leading to the development of technological standards (including mandatory safe standards), codes and methods of test; and provide technical advice and services to Government agencies upon request. The Institute shall also monitor NBS engineering standards activities and provide liaison between NBS and national and international engineering standards bodies.

.02 The Director shall direct the development, execution, and evaluation of the programs of the Institute. The Deputy Director shall assist in the direction of the Institute and perform the functions of the Director in the latter's absence.

.03 The Office of Engineering Standards Services shall cooperate with and assist producers, distributors, users and consumers, and agencies of the Federal, State, and local governments in the establishment of standards for products, and shall administer the Department of Commerce's Voluntary Product Standards program as set forth in Part 10 of Title 15, Code of Federal Regulations, "Procedures for the Development of Voluntary Product Standards".

.04 The Office of Weights and Measures shall provide technical assistance to the States with regard to model laws and technical regulations, and to the States, business, and industry in the areas of testing, specifications, and tolerances for weighing and measuring devices, to design, construction, and use of standards of weight and measure of associated instruments, and the training of State and local weights and measures officials. The office includes the Master Railway Track Scale Depot, Clearing, Illinois.

.05 The Office of Invention and Innovation shall analyze the effect of Federal laws and policies (e.g., tax, anti-trust, and regulatory policies) on the national climate for invention and innovation; undertake studies in related areas with other agencies; and assist and encourage inventors through inventors' services and programs, including cooperative activities with the States.

.06 The Product Evaluation Technology Division shall develop the technology, standards, and test methods for evaluating products including their systems, components, and materials.

.07 The Electronic Technology Division shall develop criteria for the evaluation of products and services in the general field of electronic instrumentation; cooperate with appropriate public and private organizations in identifying needs for improved technology in this field; and cooperate in the development of standards, codes and specifications. Further, it shall apply the technology of electronic instrumentation to the development of methods of practical measurement of physical quantities and properties of materials.

.08 The Technical Analysis Division shall conduct benefit-cost analyses and other basic studies required in planning and carrying out programs of the Institute. This includes the development of simulations of industrial systems and of Government interactions with industry, and the conduct of studies of alternative Institute programs. On request, the Division shall provide similar analytic services for other programs of the Department of Commerce, in particular, those of the science-based bureaus, and, as appropriate, for other agencies of the executive branch.

.09 The Measurement Engineering Division shall serve the Bureau in an engineering consulting capacity in measurement technology; and provide technical advice and apparatus development supported by appropriate research, especially in electronics, and in the combination of electronics with mechanical, thermal, and optical techniques.

.10 The Fire Technology Division shall (a) conduct data gathering, research, education and demonstration programs on fire, its causes, prevention, and control, and on the flammability of products, fabrics, and materials; (b) develop test methods and standards in flammability; and (c) coordinate all other fire research and safety activities of the National Bureau of Standards.

.11 The Center for Building Technology shall consult with industry, government agencies, professional associations, labor organizations, consumers, and such organizations as the National Conference of States on Building Codes and Standards in developing test methods for evaluating the performance of buildings including their materials and components, the support and stability characteristics of their elements and systems, the effects of new design strategies, their fire safety and environmental characteristics, and their service and communication systems; formulating performance criteria for building design and urban systems; and performing research, including research on safety factors, in the systems approach to building design and construction, in improving construction and management efficiency, in building material characteristics, in structural behavior, and in building environmental systems.

a. The Director shall report to the Director, Institute for Applied Technology and shall direct the development, execution and evaluation of the programs of the Center. The Deputy Director shall assist in the direction of the Center and perform the functions of the Director in the latter's absence.

b. The organizational units of the Center for Building Technology shall be:

- Office of Housing Technology
- Office of Federal Building Technology
- Office of Building Standards and Codes Services
- Building Environment Division
- Structures, Materials and Life Safety Division
- Technical Evaluation and Application Division.

SECTION 12. EFFECT ON OTHER ORDERS.

This order supersedes Department Organization Order 30-2B of November 16, 1970, as amended.

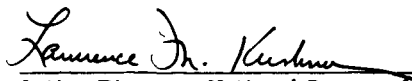
  
Acting Director, National Bureau of Standards

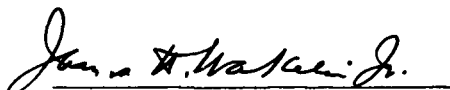
  
Assistant Secretary for Science and Technology

Approved:

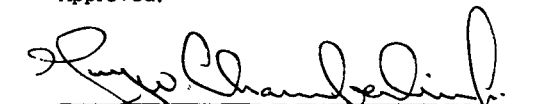
  
Acting Assistant Secretary for Administration

USCOMM-DC - 50368

**U.S. DEPARTMENT OF COMMERCE**  
**National Bureau of Standards**

Attachment to DDD 30-2B

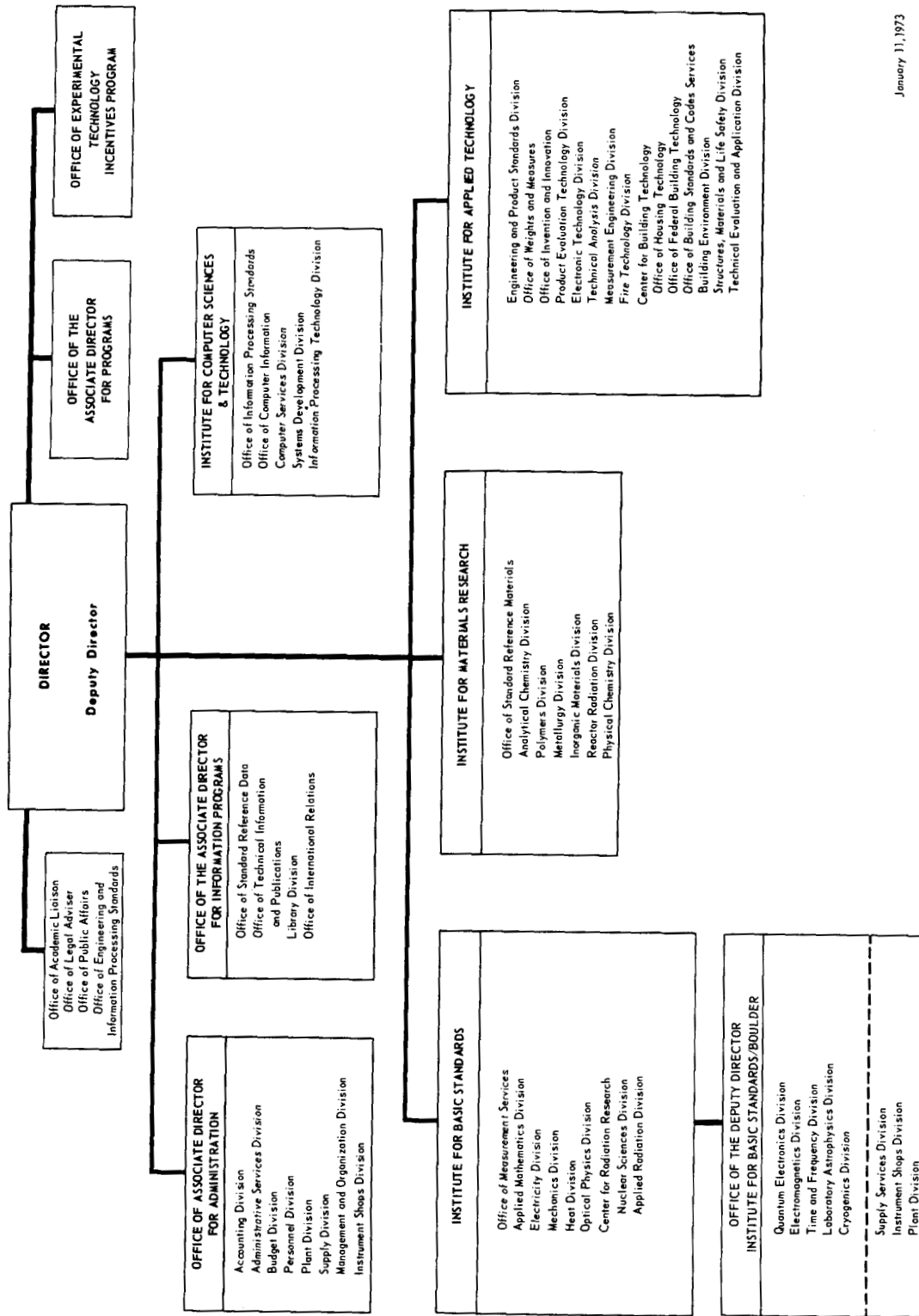

January 11, 1973  
Amendment 2



**Annex 11.B.**  
**USNO AUTHORIZING DOCUMENTS**

**Contents**

	Page
11.B.1. Executive Order 9126, April 1942 – Organizational Location.....	349
11.B.2. Reorganization Plan No. 3, May 1946.....	350
11.B.3. U.S. NAVAL OPERATIONS INSTRUCTION 5450.90B, DEC. 16, 1969 – MISSION AND FUNCTIONS OF THE U.S. NAVAL OBSERVATORY.....	357

## ANNEX 11.B.1.

THE WHITE HOUSE,  
April 7, 1942.

### EXECUTIVE ORDER 9126\*

**TRANSFERRING COGNIZANCE OF THE DUTIES  
AND FUNCTIONS OF THE HYDROGRAPHIC  
OFFICE AND THE NAVAL OBSERVATORY  
FROM THE BUREAU OF NAVIGATION, NAVY  
DEPARTMENT, TO THE CHIEF OF NAVAL  
OPERATIONS**

By virtue of the authority vested in me by Title I of the First War Powers Act, 1941, approved December 18, 1941 (Public Law 354, 77th Congress), and for the more effective exercise and more efficient administration of my powers as Commander in Chief of the Army and Navy, it is hereby ordered as follows:

1. The duties and functions of the Hydrographic Office and Naval Observatory, Bureau of Navigation, Navy Department, are hereby transferred to the cognizance and jurisdiction of the Chief of Naval Operations under the direction of the Secretary of the Navy.

2. All personnel, together with the whole of the records and public property now under the cognizance of the Bureau of Navigation in the Hydrographic Office and the Naval Observatory are assigned and transferred to the Office of Chief of Naval Operations.

FRANKLIN D ROOSEVELT

THE WHITE HOUSE,  
April 8, 1942.

Page 1137

---

\*Office of Federal Register, *Code of Federal Regulations*, Title 3 (The President, 1938-1943 Compilation), "transferring cognizance of the duties and functions of the Hydrographic Office and the Naval Observatory from the Bureau of Navigation, Navy Department, to the Chief of Naval Operations," *Executive Order 9126*, Franklin D. Roosevelt, April 1942, page 1137 (USGPO, 1968).

## ANNEX 11.B.2.

[118] May 16 *Public Papers of the Presidents*

### 118 Special Message to the Congress Transmitting Reorganization Plan 3 of 1946. May 16, 1946\*

*To the Congress of the United States:*

I transmit herewith Reorganization Plan No. 3 of 1946, prepared in accordance with the provisions of the Reorganization Act of 1945.

The Plan contains reorganizations affecting a number of departments and establishments. Some continue on a permanent basis changes made by Executive order under authority of the First War Powers Act. A few make adjustments in the distribution of functions among agencies. The remainder deal with problems of organization within individual agencies. All are concerned with improving and simplifying particular phases of Government administration.

Each proposal is explained in more detail under the appropriate heading below.

I have found, after investigation, that each reorganization contained in the Plan is necessary to accomplish one or more of the purposes set forth in section 2(a) of the Reorganization Act of 1945.

#### DEPARTMENT OF THE TREASURY

The functions of the Bureau of Marine Inspection and Navigation were transferred from the Department of Commerce to the Coast Guard and the Bureau of Customs in 1942 by Executive order under the First War Powers Act. This arrangement has been proved successful by the experience of the past four years. Part I of the Reorganization Plan continues the arrangement on a permanent basis.

#### *United States Coast Guard*

The principal functions of the Bureau of Marine Inspection and Navigation were those of the inspection of vessels and their

equipment, the licensing and certificating of officers and seamen, and related functions designed to safeguard the safety of life and property at sea. Thus these functions are related to the regular activities and general purposes of the Coast Guard. The Coast Guard administered them successfully during the tremendous expansion of wartime shipping, by virtue of improvements in organization and program, many of which ought to be continued.

The Plan also transfers to the Coast Guard the functions of the Collectors of Customs relating to the award of numbers to undocumented vessels. These functions, too, were temporarily transferred to the Coast Guard in 1942.

#### *Bureau of Customs*

The Plan transfers to the Commissioner of Customs the functions of the Bureau of Marine Inspection and Navigation and the Secretary of Commerce relating to the documentation of vessels, measurement of vessels, administration of tonnage tax and tolls, entry and clearance of vessels and aircraft, regulation of coastwise trade and fisheries, recording of conveyances and mortgages of vessels, and protection of steerage passengers. These functions have always been performed at the ports by the Customs Service, although legal responsibility for their supervision was vested in the Bureau of Marine Inspection and Navigation and the Secretary of Commerce until transferred temporarily to the Commissioner of Customs under the wartime reorganization power.

The proposed transfer will permit more efficient administration by ending divided responsibility.

\*Grover, W. C. (Archivist), *Public Papers of the Presidents of the United States—Harry S Truman—1946*, "No. 118, Special message to the Congress transmitting reorganization plan 3 of 1946," pp. 260-267 (USGPO, 1962).

DEPARTMENT OF WAR AND DEPARTMENT OF  
THE NAVY*Functions with Respect to Certain Insane  
Persons*

Prior to World War I practically all mental patients for whom the Federal Government was legally obligated to provide hospital care and treatment, including personnel of the armed forces, were hospitalized in St. Elizabeths Hospital, Washington, D.C. In addition, this hospital served as the mental hospital for the District of Columbia Government. Following World War I, the responsibility for hospital care of mentally ill war veterans was assigned to the Veterans Administration. Somewhat later, specialized hospital facilities were provided by the Bureau of Prisons of the Department of Justice to enable that agency to care for prisoners suffering from mental disorders.

With the growth in the population of the District of Columbia and the wartime expansion of the armed forces, the facilities of St. Elizabeths Hospital became inadequate. The War Department therefore established its own mental hospitals at the outset of World War II. Furthermore it became necessary a year ago for the Navy Department to discontinue the use of St. Elizabeths and to assume the responsibility for the care of its mental patients.

Since the return of the Coast Guard to the Treasury Department, the Public Health Service now provides care in its mental hospitals for personnel of the Coast Guard in accordance with the basic responsibility delegated to it in the Public Health Service Code enacted in 1944. The Plan abolishes the functions of St. Elizabeths Hospital with respect to insane persons belonging to the Coast Guard which are provided for by Sec. 4843 of the Revised Statutes (24 U.S.C. 191).

Responsibility for the care of mental patients has been allocated on the basis of the four broad categories of beneficiaries, namely, (1) veterans, to be cared for by the Veterans Administration; (2) military and naval personnel, to be cared for by the War and Navy Departments; (3) prisoners, for whom the Department of Justice will be responsible; and (4) other civilians, to be cared for by the Federal Security Agency. The Reorganization Plan, in order to carry out this policy, provides for the transfer or abolition of certain functions and legal responsibilities now resting with the Federal Security Administrator and Superintendent of St. Elizabeths Hospital.

## NAVY DEPARTMENT

*Hydrographic Office and Naval Observatory*

The Plan transfers the Hydrographic Office and the Naval Observatory from the Bureau of Naval Personnel to the Office of the Chief of Naval Operations. The Plan would confirm and make permanent the action taken in 1942 by Executive Order No. 9126 under the First War Powers Act.

The functions performed by both the Hydrographic Office and the Naval Observatory relate primarily to operational matters and thus are more appropriately placed in the Office of the Chief of Naval Operations than in the Bureau of Naval Personnel. This fact was recognized in the realignment of naval functions at the outbreak of the war. The Plan merely confirms an organizational relationship which has existed successfully for the past four years.

*Supply Department of the United States  
Marine Corps*

The Plan consolidates the Paymaster's Department and the Quartermaster's Department of the United States Marine Corps into

a single Supply Department. This consolidation will establish in the Marine Corps an integrated supply organization which parallels that of the Navy Department's Bureau of Supplies and Accounts.

The consolidation will make possible a more efficient and more economical organization of the companion functions of supply and disbursement, eliminating the present handling of related items by two separate departments of the Corps.

#### DEPARTMENT OF THE INTERIOR

##### *The Franklin D. Roosevelt Library at Hyde Park*

At the present time, the National Park Service, the Public Buildings Administration, and the Archivist of the United States all perform "housekeeping" functions at the Franklin D. Roosevelt Library and home at Hyde Park. The Plan unifies in the National Park Service responsibility for activities of this character at Hyde Park—that is, the maintenance and protection of buildings and grounds, the collection of fees, and the handling of traffic and visitors. Because of its wide experience in the administration of historic sites, the National Park Service is the logical agency to assume the combined functions.

Transfer of these functions does not affect the responsibility of the Archivist for the contents and professional services of the Library proper. It also does not affect the present disposition of the receipts, which is provided by law.

##### *Functions Relating to Mineral Deposits in Certain Lands*

The Plan transfers to the Department of the Interior jurisdiction over mineral deposits on lands held by the Department of Agriculture.

262

The Department of the Interior now administers the mining and mineral leasing laws on various areas of the public lands, including those national forests established on parts of the original public domain. The Department of Agriculture, on the other hand, has jurisdiction with respect to mineral deposits on (1) forest lands acquired under the Weeks Act, (2) lands acquired in connection with the rural rehabilitation program, and (3) lands acquired by the Department as a part of the Government's effort to retire submarginal lands.

Accordingly this Reorganization Plan provides that these mineral deposits on lands of the Department of Agriculture will be administered by the Department of the Interior, which already has the bulk of the Federal Government's mineral leasing program.

The Plan further provides that the administration of mineral leasing on these lands under the jurisdiction of the Department of Agriculture will be carried on subject to limitations necessary to protect the surface uses for which these lands were primarily acquired.

##### *Bureau of Land Management*

The Plan consolidates the General Land Office and the Grazing Service of the Department of the Interior into a Bureau of Land Management.

The General Land Office and the Grazing Service now divide responsibility for the major portion of the multiple-use Federally-owned lands now held by the Department of the Interior. The lands under jurisdiction of the two agencies are comparable in character and in use. In some functions, the two agencies employ the same type of personnel and use the same techniques. Other functions are divided between the agencies so that both are engaged in management of

various aspects of the same land. Consolidating these two agencies will permit the development of uniform policies and the integration of two organizations whose responsibilities now overlap.

Integration of the activities of the two agencies will make possible greater utilization and thus more economic use of expert skills. The same practical experience embraced in range administration on public lands in grazing districts will be available for public lands outside the districts.

Utilization of lands within grazing districts for non-grazing purposes will be subject to only one classification examination, rather than dual examination as is now necessary. Economy will be possible in the construction of range improvements, wherever feasible, to serve lands both in and out of districts. Legal procedures such as adjudication of issues relating to licenses and leases, hearings on appeal from administrative decisions, and the processing of trespass cases will benefit from unified administration and handling.

In such activities as fire protection, soil and moisture conservation, management of public lands under agreement with other agencies (e.g., Bureau of Reclamation), range surveys, maintenance and improvement of stock driveways, and stabilization of range use on all public domain, the benefits of consolidation will become increasingly apparent. Further, records relating to grazing lands can be concentrated in fewer field offices and hence administered more effectively.

While the establishment of a new Bureau of Land Management under a Director involves the abolition of the Commissioner and Assistant Commissioners of the General Land Office, the Director and Assistant Directors of Grazing, the Registers of District Land Offices, and the United States

Supervisor of Surveys, the statutory functions now discharged by these officers are in no way modified. This plan will place final responsibility for these functions in the Secretary of the Interior and make him responsible for their performance in coordination with the other land activities of his Department. Officers whose offices are specifically abolished, but whose experience will make them valuable to the Department, should be available for appointment in the new Bureau.

I have found and declare that by reason of the reorganization made by the Plan the responsibilities and duties of the Bureau of Land Management are of such nature as to require the inclusion in the Plan of provisions for the appointment and compensation of a Director, an Associate Director, and Assistant Directors.

#### DEPARTMENT OF AGRICULTURE

##### *Functions of Certain Agencies of the Department of Agriculture*

To enable the Department of Agriculture to meet its responsibilities for food production and distribution during the war, there was early and continuing coordination of its programs directly concerned with these phases of the food problem. Beginning with Executive Order No. 9069 of February 23, 1942, those programs and agencies dealing with food production and distribution were gradually consolidated by a series of Executive orders issued under the authority of the First War Powers Act. By Executive Order No. 9934 of April 19, 1943, they were all grouped into a War Food Administration, under a War Food Administrator.

When the fighting was drawing to a close and the emergency purposes of the War Food Administration had been largely accomplished, this Administration was ter-

minated by Executive Order No. 9577 of June 29, 1945; and its functions and agencies were transferred back to the jurisdiction of the Secretary of Agriculture. Executive Order No. 9577 also authorized the Secretary of Agriculture to organize and administer the transferred functions and agencies in the manner which he deemed best.

Under this authority, the Secretary established the Production and Marketing Administration in August 1945. Into this Administration, he consolidated the functions of many of the production and marketing agencies which were transferred back from the War Food Administration. Included were the functions of the Agricultural Adjustment Administration and the Surplus Marketing Administration and the administration of the programs of the Federal Crop Insurance Corporation and the Commodity Credit Corporation.

The Plan transfers these functions to the Secretary of Agriculture in order to permit him to continue the consolidation already effected in the Production and Marketing Administration. This provision makes it possible to maintain the close coordination and integration of food production and distribution programs, with the resulting benefits that were achieved during the war. It also provides the Secretary with the necessary flexibility to make adjustments in the coordination and administration of these programs to meet changing conditions and new problems, a flexibility which he particularly needs at this period of acute food shortages throughout the world.

#### DEPARTMENT OF COMMERCE

##### *Certain Functions of National Bureau of Standards*

The Plan transfers the functions of two divisions of the National Bureau of Stand-

ards in the Department of Commerce, namely, the Division of Simplified Trade Practices and the Division of Commercial Standards, to the Secretary of Commerce. The transfer will permit the Secretary to reassign these functions to the Office of Domestic Commerce, which is the focal point of the Department's general service functions for American business.

These two divisions were established as a result of the standardization work initiated in World War I. Both divisions have followed the same basic procedure of assisting the producers and the consumers of particular products to agree among themselves on certain standards or on a certain limited number of varieties. Each such voluntary agreement is then published by the National Bureau of Standards and, although not compulsory, has tended to become the generally accepted practice in the trade.

Standardization again proved to be an important device for accelerating production in World War II; and industry has shown renewed interest in continuing these wartime conservation and rationalization programs on a voluntary basis in the production of peacetime products.

The desirability of the proposed transfer was emphasized only a few months ago by the report of a committee of prominent businessmen appointed by the Secretary of Commerce to review the entire question of the Government's activities in this field. These studies indicate that two major benefits will result from the transfer.

First, the association of the two divisions with the National Bureau of Standards has perhaps tended to give the impression in some quarters that voluntary standards and trade practices worked out by industry with the help of these two divisions are in some sense Government standards which are enforced on the basis of scientific and objective

tests. The transfer of these two divisions to the Department proper would reduce any such misconceptions, and make it clear that these standards and simplified practices are voluntary industry agreements in the making of which the Government acts merely in an advisory capacity.

Second, the other general services of the Department to American business, such as marketing, management, and economic and statistical services, are now concentrated in the Office of Domestic Commerce. The association of these two divisions with these other services to business will facilitate their work and enable them to make use of the wide industrial and business contacts of the Office of Domestic Commerce.

#### NATIONAL LABOR RELATIONS BOARD

##### *Strike Ballots Under the War Labor Disputes Act*

The Plan abolishes the function of conducting strike ballots which was vested in the National Labor Relations Board by Section 8 of the War Labor Disputes Act (57 Stat. 167, ch. 144). Experience indicates that such elections under the act do not serve to reduce the number of strikes and may even aggravate labor difficulties. The Congress has already forbidden the Board to expend any of its appropriations for the current fiscal year for this activity (First Deficiency Appropriation Act of 1946). I believe that the function should now be permanently abolished.

#### SMITHSONIAN INSTITUTION

##### *Canal Zone Biological Area*

The Plan transfers responsibility for the Canal Zone Biological Area to the Smithsonian Institution. At present, the Canal Zone Biological Area is an independent

agency of the Government, having as its function the administration of Barro Colorado Island in Gatun Lake as a tropical wildlife preserve and research laboratory. The Board of Directors of this agency consists of the President of the National Academy of Sciences as Chairman, the Secretary of the Smithsonian Institution, three members of the Cabinet—the Secretaries of War, Interior, and Agriculture—and three biologists.

The transfer will locate this function with comparable and related functions already assigned to the Smithsonian Institution whose staff members have participated since the beginning in developing the island as a research center. It will reduce by one the number of Government agencies. It will relieve three Cabinet members of routine duties not important enough to warrant their personal attention.

Under its existing authority the Smithsonian Institution may constitute an advisory board of biologists and departmental representatives if it finds such action necessary.

#### UNITED STATES EMPLOYMENT SERVICE

##### *Placement Functions Under Selective Training and Service Act of 1940*

The Plan transfers to the United States Employment Service the functions of the Selective Service System and its Director with respect to assisting ex-servicemen in obtaining new positions. These functions directly overlap the regular placement activities of the United States Employment Service, which is required to provide a special placement service for veterans both by its basic act and by the Servicemen's Readjustment Act of 1944. The transfer is in line with the policy of the Congress on the placement of veterans as most recently expressed in the 1944 Act. The shift will prevent



[118] May 16

*Public Papers of the Presidents*

needless duplication of personnel and facilities and will assure the best service to veterans.

HARRY S. TRUMAN

NOTE: Reorganization Plan 3 of 1946 is published in the U.S. Statutes at Large (60 Stat. 1097) and in the 1943-1948 Compilation of title 3 of the Code of Federal Regulations (p. 1065). It became effective July 16, 1946.

## ANNEX 11.B.3.

OPNAVINST 5450.90B

Dec 16 1969

### Mission and Functions of the U. S. Naval Observatory

Mission: To make such observations of celestial bodies, natural and artificial, derive and publish such data as will afford to United States Naval vessels and aircraft as well as to all availing themselves thereof, means for safe navigation, including the provision of accurate time; and while pursuing this primary function, contribute material to the general advancement of navigation and astronomy.

Functions: In carrying out this mission, the Superintendent, U. S. Naval Observatory, shall perform the following functions:

1. Supervise and direct all functions, programs, and activities of the U. S. Naval Observatory, and command shore activities as assigned by the Chief of Naval Operations.
2. Recommend policies, plans, and programs deemed necessary or appropriate to promote the operational effectiveness or efficiency of the Naval Observatory.
3. Make continuous observations of the sun, moon, planets, stars, and other celestial bodies, natural and artificial, to determine their positions and motions.
4. Compile and publish the astronomical publications required for safe navigation and fundamental positional astronomy.
5. Derive, maintain and coordinate precise time and time interval (frequency), both astronomical and atomic, for the Department of Defense; and control distribution of, and provide single management service and interservice support for precise time and time interval within the Department of Defense.
6. Collaborate worldwide with astronomers through the exchange of astronomical data in order to obtain information required for the publications of the Naval Observatory.
7. Contribute to the advancement of astronomy and navigation by the conduct of research in celestial mechanics and astronomy and the publication of the results thereof.
8. Discharge other responsibilities which may be assigned by the Chief of Naval Operations.

## **ANNEX 11.C.**

### **NBS TIME AND FREQUENCY RESPONSIBILITIES**

#### **Contents**

	<small>Page</small>
11.C.1. Time and Frequency Division (273.00—Institute for Basic Standards—IBS).....	361
a. Atomic Frequency and Time Standards Program Areas (273.00/PA).	
b. Frequency-Time Dissemination Research Section (273.01).	
c. Frequency-Time Broadcast Services Section (273.02).	

**11.C.1. Time and Frequency Division  
(273.00—Institute for Basic Standards)**

Provides custody and maintenance for NBS frequency and time interval standards and time scales. Conducts fundamental and applied research to establish such standards. Disseminates internationally coordinated frequency and time through radio broadcasts, portable clocks, and other advanced techniques. Engages in research and development on new dissemination techniques that improve accuracy and increase coverage. Develops improved instrumentation for dissemination of time and frequency. Coordinates time and frequency nationally and internationally and provides NBS time scale input to the BIH for formulation of TAI. Conducts fundamental physical research in which the techniques used in time and frequency standards are of critical importance. Disseminates information through consultation and publication.

**a. Atomic Frequency and Time Standards Program Areas  
(273.00/PA)**

Provides atomic frequency standards for the United States and develops and improves such standards. Provides, develops, and improves atomic time scales based on the frequency standards, and evaluates such time scales for consideration as a standard. Pursues fundamental research to maintain state of the art expertise in frequency standard and time scale work. Furnishes time and frequency signals to other Boulder Laboratory activities. Performs frequency and time calibration services for science, industry, commerce, and government users who require reference to the national standards.

**b. Frequency-Time Dissemination Research Section  
(273.01)**

Conducts research and development on new and improved methods of dissemination of frequency and time standards including satellites, television, very low frequency (VLF) radio signals, portable

clocks, and other advanced techniques; investigates propagation errors of time signals; provides consultation on methods of frequency and time dissemination; compares and evaluates methods of frequency and time dissemination; and makes recommendations for improvements in monitoring techniques and other mission components.

**c. Frequency-Time Broadcast Services Section (273.02)**

Provides wide dissemination of frequency and time standards primarily by radio broadcasts; investigates and develops techniques for improving the accuracy with which frequency and time can be distributed by broadcasting electromagnetic signals; measures distortion involved in the radio broadcast of time and frequency standards, particularly with regard to electronic transmitting and receiving equipment; provides consultation relative to the frequency and time broadcast services; evaluates the effectiveness of the frequency and time broadcast services; recommends improvement or modification of existing services or additions of new services; and monitors frequency and time broadcasts from various sources.

**Postdoctoral Research Awards**

From time to time the National Bureau of Standards, in cooperation with the National Research Council, offers postdoctoral research awards for study in a broad spectrum of interests in basic and applied science, engineering, and technology involving many disciplines. Currently there are four specific research areas in the Time and Frequency Division as follows:

- 1) Fundamental Noise Studies in Frequency Standards,
- 2) New Quantum Electronic Frequency Standards,
- 3) Statistical Control and the Theory of Measurement,
- 4) The Unified Time-Length Standard.

Further information is given in reference [40].

**Annex 11.D.**

**USNO PRECISE TIME AND TIME INTERVAL (PTTI) RESPONSIBILITIES**

**Contents**

	Page
11.D.1. U.S. Department of Defense (DOD) Directive 5160.51, PTTI Standards and Calibration Facilities for Use by DOD Components; 6 pages (August 31, 1971).....	365
11.D.2. U.S. Sec. Navy Instruction 4120.4, PTTI Standards and Calibration Facilities for Use by Department of Navy; 5 pages (June 6, 1972).....	371

August 31, 1971  
NUMBER 5160.51



ATSD(T)

## Department of Defense Directive

**SUBJECT** Precise Time and Time Interval (PTTI) Standards and Calibration Facilities for Use by Department of Defense Components'

- Refs.:**
- (a) DoD Directive 5160.51, "Time and Time Interval Standards and Calibration Facilities for Use by Department of Defense Components," February 1, 1965 (hereby cancelled)
  - (b) DoD Instruction 4630.4, "Support and Management Services for Precise Time and Time Interval Standards," June 22, 1966 (hereby cancelled)
  - (c) DoD Directive 4000.19, "Basic Policies and Principles for Interservice and Interdepartmental Logistic Support," August 5, 1967

### I. REISSUANCE

This Directive reissues reference (a) and consolidates references (a) and (b) which are hereby cancelled. Revisions occasioned by organizational and administrative changes are also included. There are no substantive changes.

### II. PURPOSE AND APPLICABILITY

This Directive establishes policy and assigns responsibility to a single Department of Defense Component for establishing, coordinating, and maintaining capabilities for time and time interval (astronomical and atomic) for use by all DoD Components, DoD contractors, and related scientific laboratories.

### III. DEFINITIONS

For purposes of this Directive, the following definitions will apply.

Copy to .....  
Action Op. 04B6  
RIS # 1175017

Continuation of III.

- A. Time signifies epoch, that is, the designation of an instant on a selected time scale, astronomical or atomic. It is used in the sense of time of day.
- B. Time Interval indicates the duration of a segment of time without reference to when the time interval begins and ends. Time interval may be given in seconds of time.
- C. Standards signifies the reference values of time and time interval. These standards are determined by astronomical observation and by the operation of atomic clocks. They are disseminated by transport of clocks, radio transmissions, and by other means.
- D. Precise Frequency signifies a frequency requirement to within one part in  $10^9$  of an established time scale.
- E. Precise Time signifies a time requirement within ten milliseconds.

IV. POLICY

- A. Resources for uniform and standard time and time interval operations and research shall be the responsibility of a single DoD Component.
- B. The maximum practicable interchange of time and time interval information shall be effected throughout the DoD.
- C. Maximum practical utilization of interservice support will be achieved as prescribed in reference (c).

V. RESPONSIBILITIES

- A. The U. S. Naval Observatory (hereafter referred to as the "Observatory") is assigned the responsibility for insuring:
  - 1. Uniformity in precise time and time interval operations including measurements.
  - 2. The establishment of overall DoD requirements for time and time interval.

Continuation of V.

3. The accomplishment of objectives requiring precise time and time interval with minimum cost.
- B. In carrying out the above responsibilities, the Observatory shall:
1. Derive and maintain standards of time and time interval, both astronomical and atomic.
  2. Provide coordination of such standards with recognized national and international standards to insure world-wide continuity of precision.
  3. Monitor conferences concerning time and time interval standards.
  4. Advise and provide guidance to DoD Components, contractors, and scientific laboratories on matters concerning time and time interval, and their measurement.
- C. All DoD Components which require, utilize, or distribute time and time interval information or have a need for a specific time scale shall:
1. Refer time and time interval to the standards established by the Observatory.
  2. Maintain specific time scales such that relationship to the standard established by the Observatory is known.
  3. Prescribe technical requirements for the coordination of techniques, procedures and periodic calibrations of systems.
  4. Promote economy by prescribing requirements for precise time that are consistent with operational and research needs for accuracy.



## VI. DELINEATION OF FUNCTIONS

- A. The Observatory is the single DoD Component responsible for PTTI management control functions. This responsibility encompasses overall activities requiring time to within ten milliseconds and frequency to within one part in  $10^9$  of an established time scale. In carrying out these PTTI functions on a common-servicing basis, the Observatory will:
1. Issue detailed information concerning reference values for PTTI and distribute them by means of controlled radio transmissions and portable atomic clocks.
  2. Promote (a) operational uniformity of PTTI functions, including measurements; (b) establishment of overall DoD PTTI requirements; and (c) accomplishment of objectives requiring PTTI at minimum cost.
  3. Monitor DoD research programs concerning PTTI (frequency), in coordination with the Office of the Director of Defense Research and Engineering.
  4. Review (a) existing and future PTTI (frequency) requirements of the DoD user components in order to establish overall DoD requirements and to provide adequate supporting services; and (b) existing PTTI operations conducted by DoD user components to provide guidance and recommendations to the Assistant to the Secretary of Defense (Telecommunications).
  5. Establish relationships between the DoD and other Federal Government agencies on PTTI matters.
  6. Provide advice and guidance concerning requests for unilateral PTTI (frequency) programs at the direction of Assistant to the Secretary of Defense (Telecommunications).
  7. Participate in PTTI policy negotiations between the DoD and other Federal Government agencies and international organizations.

Continuation of VI. A.

8. Maintain records of PTTI (frequency) arrangements between the DoD and its contractors and other Federal Government agencies, with the exception of radio frequency assignments.

B. DoD User Components

1. DoD Components presently conducting Precise Time and Time Interval operations and research may continue these activities unless otherwise instructed by the Assistant to the Secretary of Defense (Telecommunications).
2. The Military Departments will assist the Observatory by (a) providing technical information on current and prospective programs involving PTTI applications; and (b) distributing, monitoring and controlling PTTI services on request, subject to the provisions of this Directive and the availability of funds.

C. DoD User Components and contractors will:

1. Consult the Observatory on any technical and logistic problems arising from obtaining a particular accuracy through radio transmissions and portable atomic clocks.
2. Use DoD-controlled transmissions to the maximum extent practicable. Other transmissions of time and frequency which have been coordinated with the Observatory may be used when DoD transmissions do not provide adequate coverage.
3. Refer measurements and contract specifications to DoD standards determined by the Observatory.
4. Use techniques and procedures described in information documents issued by the Observatory in all cases where such documents satisfy the need.
5. Notify the Observatory of:
  - a. Existing and planned PTTI requirements, including information as to accuracy and stability of needs,

Continuation of VI. C. 5. a.

measurement techniques planned or in operation, and continuity of service required of the applicable distribution transmission.

- b. PTTI (frequency) arrangements between DoD user components and contractors and other Federal Government agencies (see paragraph VI. A. 8. above); and
  - c. Scheduled scientific and technical meetings on PTTI (frequency).
6. Consult the Observatory prior to entering into contracts for equipment, research, studies, or services involving PTTI (frequency) in order that maximum use of existing facilities may be assured.

VII. EFFECTIVE DATE AND IMPLEMENTATION

This Directive is effective immediately. It shall be given full distribution by all DoD Components. Two copies of each implementing document shall be forwarded to the ATSD(T) within 90 days.

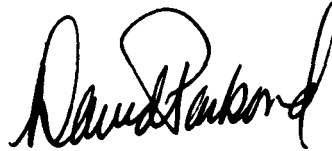

Deputy Secretary of Defense

## ANNEX 11.D.2.



DEPARTMENT OF THE NAVY  
OFFICE OF THE CHIEF OF NAVAL OPERATIONS  
WASHINGTON, D. C. 20350

IN REPLY REFER TO  
OPNAVINST 4120.4  
NAVOBSY

6 JUN 1972

OPNAV INSTRUCTION 4120.4

From: Chief of Naval Operations

Subj: Precise Time and Time Interval (PTTI) Standards and  
Calibration Facilities for use by Department of the  
Navy

Ref: (a) DoD Directive 5160.51 of 31 Aug 1971 (NOTAL)  
(b) SECNAV Instruction 4355.11B of 16 Jul 1969 (NOTAL)

1. Purpose. To implement reference (a) within the Department of the Navy.

2. Scope and Applicability. The scope of this instruction includes: the generation of operational and research requirements for PTTI (frequency); the establishment, coordination, maintenance, distribution, and utilization of standard values for time and frequency; and the coordination of the Department of the Navy with other components of the Department of Defense with respect to precise time and frequency operations, techniques, procedures, measurements, and calibrations.

3. Definitions. For purposes of this instruction, the following definitions will apply:

a. Time signifies epoch, that is, the designation of an instant on a selected time scale, astronomical or atomic. It is used in the sense of time of day or date.

b. Time Interval indicates the duration of a segment of time without reference to when the time interval begins and ends. Time interval may be given in seconds of time.

c. Standards signify the reference values of time and time interval. These standards are determined by astronomical observation and by the operation of atomic clocks. They are disseminated by transport of clocks, radio transmissions, and by other means.

d. Precise Frequency signifies a frequency requirement to within one part in  $10^9$  of an established time scale.

e. Precise Time signifies a time requirement within ten milliseconds.

6 June 1972

4. Policy

a. The epoch and the interval of time (frequency) as determined by the U. S. Naval Observatory (NAVOBSY) shall be utilized as standards within the Department of the Navy.

b. Designated Department of the Navy facilities and systems which are capable of distributing precise time or frequency information, such as radio communications, satellites, and radio navigation systems, shall transmit the standards determined by the NAVOBSY.

c. Addressees requiring precise time and frequency shall make their requirements known to the Superintendent, NAVOBSY or the Chief of Naval Material (CNM), and shall obtain guidance as appropriate in preparing Specific Operational Requirements (SOR), Advanced Development Objectives (ADO), Proposed Technical Approaches (PTA), Technical Development Plans (TDP), and similar planning instruments.

d. Organizations with future requirements for precision or geographic coverage exceeding those provided by existing distribution systems shall make these requirements known to the Superintendent, NAVOBSY.

5. Responsibilities

a. The NAVOBSY is assigned the responsibility for insuring uniformity in PTTI (frequency) operations for DoD including measurements. The CNM is responsible for assuring this uniformity within the Department of the Navy.

b. The CNM is assigned the responsibility for insuring:

(1) The establishment of overall Department of the Navy requirements for time and time interval.

(2) The accomplishment of objectives requiring PTTI (frequency) with minimum cost.

c. In carrying out the above responsibilities,

(1) The NAVOBSY shall:

(a) Derive and maintain standards of time and time interval, both astronomical and atomic.

(b) Provide coordination of such standards with recognized national and international standards to insure worldwide continuity of precision.

(c) Issue detailed information concerning reference values of PTTI (frequency) and distribute them by means of controlled radio transmissions, portable atomic clocks, and other appropriate means.

(d) Establish relationships between the Department of the Navy and other DoD agencies on PTTI (frequency) matters.

(e) Provide advice and assistance as required.

(2) The CNM shall:

(a) Sponsor and monitor conferences concerning time and time interval standards in coordination with the NAVOBSY.

(b) Advise and provide guidance to Department of the Navy components, contractors, and scientific laboratories on matters concerning time and time interval, and their measurement.

(c) Prescribe technical requirements for the coordination of techniques, procedures, and periodic calibration of systems.

d. All Department of the Navy components which require, utilize, or distribute time and time interval information or have a need for a specific time scale shall:

(1) Refer time and time interval to the standards established by the NAVOBSY.

(2) Maintain specific time scales such that relationship to the standard established by the NAVOBSY is known.

(3) Promote economy by prescribing requirements for precise time that are consistent with operational and research needs for accuracy.

6. Delineation of Functions

a. The CNM is the single Department of the Navy manager responsible for PTTI (frequency) management control functions. This responsibility encompasses overall activities requiring time to within ten milliseconds and frequency to within one part in  $10^9$  of an established time scale. In carrying out these PTTI (frequency) functions, the CNM will:

(1) Promote (a) operational uniformity of PTTI (frequency) functions; and (b) establishment of overall Department of the Navy PTTI (frequency) requirements.

(2) Monitor Department of the Navy research programs concerning PTTI (frequency), in coordination with the NAVOBSY.

(3) Sponsor Department of the Navy research and development programs for PTTI (frequency) and PTTI applications, in coordination with the NAVOBSY.

(4) Review (a) existing and future PTTI (frequency) requirements of the Department of the Navy user components in order to establish overall Department of the Navy requirements and to provide adequate supporting services; and (b) existing PTTI (frequency) operations conducted by Department of the Navy user components to provide guidance and recommendations to the NAVOBSY.

(5) Provide training, maintenance, repair, and calibration services for Department of the Navy PTTI (frequency) equipment and systems.

(6) Provide advice and guidance concerning requests for unilateral PTTI (frequency) programs at the direction of the NAVOBSY.

(7) Participate in PTTI (frequency) policy negotiations in coordination with the NAVOBSY, between the Department of the Navy and other DoD agencies.

(8) Maintain records of PTTI (frequency) arrangements between the Department of the Navy and its contractors, with the exception of radio frequency assignments.

b. Department of the Navy user components will assist the CNM by (1) providing technical information on current and prospective programs involving PTTI (frequency) applications; and (2) distributing, monitoring, and controlling PTTI (frequency) services on request.

c. Department of the Navy User Components and Contractors will:

- (1) Consult the CNM on any technical and logistic problems arising from PTTI (frequency) operations or research.
- (2) Use DoD-controlled transmissions to the maximum extent practicable. Other transmissions of time and frequency which have been coordinated with the NAVOBSY may be used when DoD transmissions do not provide adequate coverage.
- (3) Refer measurements and contract specifications to DoD standards determined by the NAVOBSY.
- (4) Use techniques and procedures described in information documents issued by the NAVOBSY in all cases where such documents satisfy the need.
- (5) Notify the CNM of existing and planned PTTI (frequency) requirements, including information as to accuracy and stability of needs, measurement techniques planned or in operation, and continuity of service required of the applicable distribution transmission.
- (6) Consult the CNM prior to entering into contracts for equipment, research, studies, or services involving PTTI (frequency) in order that maximum use of existing facilities may be assured.

7. Action

a. The Chief of Naval Operations (CNO) designates and places operational requirements upon those naval facilities and systems which will transmit the time and frequency standards determined by the NAVOBSY. The CNO also provides and maintains suitable facilities for the NAVOBSY to carry out the responsibilities assigned.

b. The CNM, as directed by the CNO and in accordance with reference (b), will coordinate compliance, as necessary.

DISTRIBUTION:  
See page 6.

  
T.F. DEDMAN  
Assistant Vice Chief of Naval Operations  
Director of Naval Administration



## Annex 11.E.

### NBS/USNO TIME COORDINATION/SERVICES

#### Contents

	Page
11.E.1. USNO Time Reference Stations, <i>USNO Time Service Announcement</i> , Series 14, No. 1, 17 April 1968.....	379
11.E.2. Coordination of Clock Time Scales, <i>USNO Time Service Announcement</i> , Series 14, No. 3, 8 October 1968.....	381
11.E.3. NBS—“Nation Gets Unified Time System,” <i>Nat. Bur. Stand. (U.S.) Tech. News Bull.</i> , <b>53</b> , No. 2, p. 34, February 1969.....	382
11.E.4. NBS Time and Frequency Publication Services.....	383
11.E.5. USNO Time Service Publications.....	384

# ANNEX 11.E.1.

U. S. NAVAL OBSERVATORY  
WASHINGTON, D.C. 20390

17 April 1968

TIME SERVICE ANNOUNCEMENT, Series 14

NO. 1

## U. S. Naval Observatory Time Reference Stations

1. Precise time measurements against the Master Clock maintained by the U. S. Naval Observatory in Washington, D.C., may also be made at the locations listed below. Reference atomic clocks have been set up, or designated at these locations, and their time differences with the U. S. Naval Observatory Master Clock are measured regularly and are known to an accuracy of better than  $\pm 2.5$  microseconds.

Present locations of Time Reference Stations:

Master Clock:

U. S. Naval Observatory  
Time Service Division  
Washington, D. C. 20390

Tel: AUTOVON  
Commercial: 202 696-8423  
TWX: 710 822 1970

Time Reference Stations:

(a) National Bureau of Standards  
Boulder, Colorado

Tel: FTS  
Commercial: 303 449-1000  
TWX:

(b) U. S. Naval Observatory Time Service Substation  
Miami (Perrine), Florida

Tel: Commercial: 305 235-0515  
TWX: 305 238 3451

(c) U. S. Navy Astronautics Group  
Detachment CHARLIE  
Wahiawa, Oahu, Hawaii

Tel: AUTOVON  
Commercial: 4315523  
TWX:

(d) U. S. Coast Guard Loran Monitoring Station  
Building 683  
Fuchu Air Station  
Fuchu-Shi, Tokyo-To, Japan

Tel: AUTOVON  
Commercial: 45700 or 47188  
TWX:

(e) Hewlett Packard Company  
Palo Alto, California

Tel: Commercial: 415 326-7000  
TWX: HEWPACK

(f) Hewlett Packard Company  
Geneva, Switzerland

Tel: Commercial: 022 42.81.50  
TWX: HEWPACKSA

2. Recent measurements are reported in the U. S. Naval Observatory Phase Value Bulletins and messages.

3. For further information, contact the:

Superintendent  
U. S. Naval Observatory  
Washington, D. C. 20390

J. M. McDOWELL  
Superintendent

## ANNEX 11.E.2.

U. S. NAVAL OBSERVATORY  
WASHINGTON, D.C. 20390

8 October 1968

TIME SERVICE ANNOUNCEMENT, SERIES 14

NO. 3

### Coordination of Clock Time Scales

1. In the interest of improved coordination between the National Bureau of Standards, the U. S. Naval Observatory, and international timekeeping centers, the frequency of the U. S. Naval Observatory clock time scales was lowered 4 parts in  $10^{13}$  on 1 October 1968 at 0<sup>h</sup> UT.
2. Effective 1 October 1968 all daily phase values and clock measurements published by the U. S. Naval Observatory will be given with respect to these improved coordinated time scales. Clocks which were running perfectly with respect to UTC(USNO) before 1 October 1968 will now show an apparent daily rate of 34.56 nanoseconds (fast).
3. For most timing applications this change will be insignificant since it is less than the random fluctuations of individual atomic clocks.

J. MAURY WERTH  
Superintendent

## ANNEX 11. E. 3.

*The Nation's two "time keepers"—the National Bureau of Standards, Boulder, Colo. (top) and the U.S. Naval Observatory, Washington, D.C.—recently synchronized their clocks to provide the country with a unified time system of unsurpassed accuracy.*

# NATION GETS Unified Time System

**NBS and Naval Observatory Synchronize Time to About 1 Microsecond**

A UNIFIED TIME SYSTEM of unsurpassed accuracy for the entire country was achieved recently when the Nation's two "time keepers"—the National Bureau of Standards and the U.S. Naval Observatory (USNO)—synchronized their clocks. On October 1, 1968, these agencies cooperated to effect a much more precisely coordinated time system than has ever before existed. The action taken by these agencies was the synchronization of their Coordinated Universal Time (UTC) clocks to within about 1 microsecond of each other. Synchronization was achieved when the NBS Time and Frequency Division (Boulder, Colo.) increased the rate of its UTC(NBS) clock by 4 parts in  $10^{13}$ , while the Naval Observatory (Washington, D.C.) decreased the rate of its UTC(USNO) clock by 4 parts in  $10^{13}$ .

The Bureau and the USNO have been cooperating under regulations of the International Radio Consultative Committee (CCIR), which for the past several years has required synchronization of standard time broadcasts to one thousandth of a second. This has been adequate for most users, but as technology has advanced, many precise timing needs have developed that cannot be met by this tolerance. More than a year ago, the desirability of synchronizing the USNO and NBS frequency and time standards to much finer tolerances than 1 millisecond was recognized.

In anticipation of a coordinated coordinate rate for USNO and NBS, on August 24, 1967, the Coordinated Universal Time clock of the Bureau, UTC(NBS), and all UTC transmissions of NBS were advanced by 200 microseconds. This left NBS about 35 microseconds early relative to USNO.

As the rate of the USNO clock has been high relative to the NBS clock by about 1 part in  $10^{12}$ , the two clocks drifted toward each other. Their time lines converged on about October 1, 1968, and the time difference between the USNO clock, UTC(USNO), and the NBS clock, UTC(NBS), became zero. At that time USNO reduced the rate of its clock by 4 parts in  $10^{13}$ , and NBS increased the rate of its clocks controlling NBS standard transmissions by 4

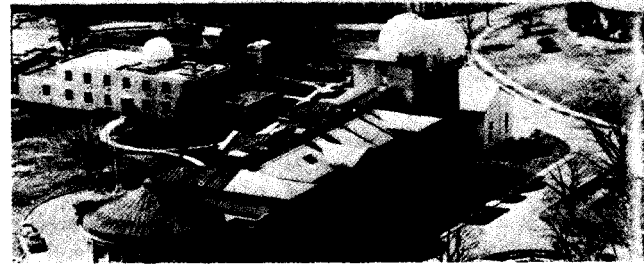
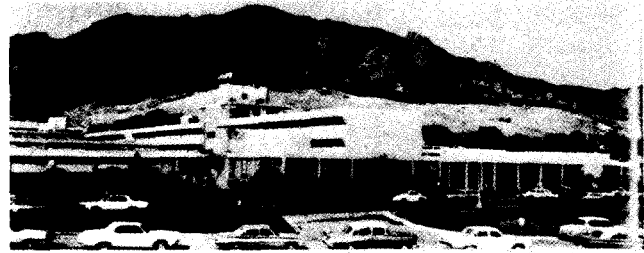

parts in  $10^{13}$ . (A clock running fast by 4 parts in  $10^{13}$  accumulates about 35 billionths of a second error per day. This rate of error would require about 80 000 years to accumulate one second in error.) The present specified absolute accuracy of the rate of the NBS clock is  $\pm 5$  parts in  $10^{12}$ .

Measurements made after October 1 with portable clocks indicate that the time difference between the USNO and the NBS coordinated clocks is within one microsecond. By mutual agreements between USNO and NBS, small frequency adjustments ( $< 10^{-12}$ ) will be made infrequently to assure that this time difference remains less than about three microseconds.

Among scientists requiring more precise time measurements are geodesists, who, in attempting to measure the Earth very accurately, must sight on an artificial satellite from distant locations at very nearly the same instant of time. The sightings must be made within about 100 microseconds of each other, but the geodesists would prefer that the time error be within 10 microseconds. There are also military and NASA requirements that require synchronization accuracies in the microsecond range. It should be emphasized that this is synchronization accuracy and not absolute time-of-day accuracy.

Meanwhile, there is a general trend in technology toward tighter tolerances on synchronization. For example, the planned Aircraft Collision Avoidance System (ACAS) specifies worldwide synchronization accuracy of 0.5 microsecond, which is possibly beyond the current state-of-the-art.

To meet such needs, the National Bureau of Standards and U.S. Naval Observatory are engaged in a joint effort to provide a unified time service to all the United States. The new system is near the limit of the present state-of-the-art in its ability to provide accurate time and time synchronization to remote locations. This synchronization system is expected to provide a working model of a coordinate time system suitable for extension to worldwide coverage at some later date.

*NBS Technical News Bulletin*

## ANNEX 11.E.4.

### NBS Time and Frequency Publication Services\*

- A. Publishes a monthly *Time and Frequency Services Bulletin*. Typical table of contents as follows: (Sec. 273.01)

#### CONTENTS

1. TIME SCALE INFORMATION\*  
Relations of some time scales to the AT(NBS) and UTC(NBS)<sup>1</sup> Time Scales.
2. ADJUSTMENTS IN NBS BROADCAST TIME PULSES  
Listed are adjustments in broadcast time pulses dated from January 1, 1972. Notices of future adjustments will be made when they are available from the BIH. These adjustments are made to maintain the broadcast pulses within about  $\pm 0.7$  seconds of the UT1 scale. The UT1 scale is slightly non-uniform due to variations in the rotation of the earth about its axis.
3. DAILY PHASE DEVIATIONS FOR NBS STATIONS\*  
Day-by-day transmitted phase deviations measured from 1800 UT to 1800 UT, referred to the UTC(NBS) time marker, are listed for station WWVB. General time and frequency information is listed for stations WWV and WWVH.
4. PHASE DEVIATIONS FOR NON-NBS STATIONS\*  
Listed are day-by-day phase deviations measured with respect to the UTC(NBS) time marker and obtained by monitoring non-NBS stations.
- 5A. OUTAGES OF NBS RADIO BROADCASTS  
Interruptions in service from NBS radio stations.
- 5B. SCHEDULED OUTAGES OR ALTERATIONS IN NBS RADIO BROADCASTS  
Advance notice of scheduled interruptions or changes in service.
- 6A. DAILY TELEVISION TIME TRANSFER MEASUREMENTS  
Daily readings for the three major U. S. networks of the difference between UTC(NBS) and the trailing edge of the next line 10 (odd) horizontal synchronization pulse as received in Boulder, Colorado.
- 6B. DAILY TELEVISION FREQUENCY TRANSFER MEASUREMENTS\*  
Listed are the average fractional frequencies with respect to the NBS primary frequency standard for each of the three rubidium gas cell frequency standards used at each of the corresponding major network originating studios.
7. NBS FREQUENCY AND TIME SATELLITE EXPERIMENT  
Antenna pointing angles to the satellite and propagation delays from NBS Boulder to the user via the satellite are presented. General information important to the users of the experimental service is also given.
8. EXPLANATION OF TIME SCALES AND DEFINITIONS OF TERMS  
(not in every issue) - The NBS Time Scales--their derivation and relation to each other and to those of other laboratories. Definitions of all terms used in this bulletin.
9. NOTES (not in every issue)  
Corrections, additions, deletions, and special announcements.

\*The sign convention used in this bulletin follows the recommendations of the CCIR.

<sup>1</sup>See notes, part 9.

No. 177, August 1972

- B. Sends advance notice of revisions to NBS standard frequency broadcasts to users on basis of need. (Sec. 273.01)
- C. Periodically sends a bibliographic listing of NBS published documents pertaining to frequency and time standards or related metrology to interested users. (273.00/PA)
- D. Services a mailing list for current scientific and technical publications maintained in Atomic Frequency and Time Standards Program Area. Forwards reprints of papers as they become available. (273.00/PA)

\*Material available upon request to NBS Time and Frequency Sections involved or to Chief Time and Frequency Division, National Bureau of Standards, Boulder, Colorado 80302.

## ANNEX 11.E.5.

### USNO Time and Frequency Publications\*

A. Publishes Time Service Publications (see ref. [41]) as follows:

Series	Title
1.	<i>List of Worldwide VLF and HF Transmissions</i> suitable for Precise Time Measurements. Includes: Call sign, geographic location, frequencies, radiated power, etc. (Time Signal Transmissions).
2.	<i>Schedule of U.S. Navy Time Signal Transmissions</i> in VLF and HF bands. Includes: Times of broadcast, frequencies, etc.
3.	<i>Schedule of U.S. Navy VLF Transmissions</i> including Omega system. Includes: Location, frequencies, power radiated, maintenance periods, type of transmission, etc.
4.	<i>Daily Relative Phase Values</i> (Issued weekly). Includes: Observed phase and time differences between VLF, LF, Omega, Television, Portable Clock measurements, and Loran-C stations and the UTC(USNO Master Clock). Propagation disturbances are also given.
5.	<i>Daily Teletype Messages</i> (sent every working day). Includes: Daily relative phase and time differences between UTC(USNO MC) and VLF, LF, Omega, Loran-C stations. Propagation disturbances and notices of immediate concern for precision timekeeping.
6.	<i>USNO A.1-UT1 Data</i> . Preliminary daily values distributed monthly with final data issued as available.
7.	<i>Preliminary Times and Coordinates of the Pole</i> (issued weekly). Includes: General time scale information; UT1-UTC predicted 2 weeks in advance; time difference between A.1. UT1, UT2, UTC(BIH) and UTC(USNO), provisional coordinates of the pole; DUT1 value; and satellite information.

\*Available upon request to Director, Time Service Division USNO, Washington, DC 20390.

Series	Title
8.	<i>Time Service Announcements</i> pertaining to synchronization by television. Includes: times of coincidence (NULL) ephemeris tables.
9.	<i>Time Service Announcements Pertaining to Loran-C</i> . Includes: Change in transmissions and repetition rates, times of coincidence (NULL) ephemeris tables, coordinates and emission delays, general information, etc.
10.	<i>Astronomical Programs</i> (issued when available). Includes: Information pertaining to results, catalogs, papers, etc., of the Photographic Zenith Tube (PZT), Danjon Astrolabe, and Dual-Rate Moon Position Camera.
11.	<i>Time Service Bulletins</i> . Includes: Time differences between coordinated stations and the UTC Time Scale; earth's seasonal and polar variations (as observed at Washington, D.C. and Florida); Provisional coordinates of the pole; adopted UT2-A.1, etc.
12.	Time Service Internal Mailing.
13.	Time Service Internal Mailing.
14.	<i>Time Service General Announcements</i> . Includes: General information pertaining to time determination, measurement, and dissemination. Should be of interest to all Time Service Addressees.
15.	<i>Bureau International de l'Heure (BIH) Circular D: Heure Definitive et Coordonnées du Pôle a 0<sup>h</sup>TU</i> . Includes: Coordinates of the pole; UT2-UTC, UT1-UTC, and TA (AT)-UTC; UTC-Signal. NOTE: USNO Time Service will distribute Circular D of the BIH to U.S. addressees only.
16.	<i>Communication Satellite Reports</i> giving the differences UTC(USNO)-SATCOM Clock for each of the available SATCOM stations.
17.	<i>Transit Satellite Reports</i> . Includes Satellite Clock-UTC(USNO) and the frequency offset for each of the operational satellites.

B. Publishes Proceedings of Annual PTTI Meetings (e.g. [28]).

## ANNEX 11.F.

### TREATY OF THE METER\*

**Metric Convention:** Signed at Paris, May 20, 1875; ratification advised by the Senate, May 15, 1878; ratified by the President, May 28, 1878; ratifications exchanged, August 2, 1878; proclaimed, September 27, 1878. As amended by the convention signed at Sevres, October 6, 1921; ratification advised by the Senate, January 5, 1923; ratified by the President, September 19, 1923; ratification of the United States, deposited with the Government of the French Republic, October 24, 1923; proclaimed, October 27, 1923.

His Excellency the President of the United States of America, His Majesty the Emperor of Germany, His Majesty the Emperor of Austria-Hungary, His Majesty the King of the Belgians, His Majesty the Emperor of Brazil, His Excellency the President of the Argentine Confederation, His Majesty the King of Denmark, His Majesty the King of Spain, His Excellency the President of the French Republic, His Majesty the King of Italy, His Excellency the President of the Republic of Peru, His Majesty the King of Portugal and the Algarves, His Majesty the Emperor of all the Russias, His Majesty the King of Sweden and Norway, His Excellency the President of the Swiss Confederation, His Majesty the Emperor of the Ottomans, and His Excellency the President of the Republic of Venezuela, desiring international uniformity and precision in standards of weight and measure, have resolved to conclude a convention to this effect, and have named as their plenipotentiaries the following: • • •

Who, after having exhibited their full powers, which were found to be in good and due form, have agreed upon the following articles:

**Article 1.** The high contracting parties engage to establish and maintain, at their common expense, a scientific and permanent international bureau of weights and measures, the location of which shall be at Paris.

**Art. 2.** The French Government shall take all the necessary measures to facilitate the purchase, or, if expedient, the construction, of a building which shall be especially devoted to this purpose, subject to the conditions stated in the regulations which are subjoined to this convention.

**Art. 3.** The operation of the international bureau shall be under the exclusive direction and supervision of an international committee of weights and measures, which latter shall be under the control of a general conference for weights and measures, to be composed of the delegates of all the contracting Governments.

**Art. 4.** The general conference for weights and measures shall be presided over by the president for the time being of the Paris Academy of Sciences.

**Art. 5.** The organization of the bureau, as well as the formation and the powers of the international committee, and of the general conference for weights and measures, are established by the regulations subjoined to this convention.

**Art. 6.** The international bureau of weights and measures shall be charged with the following duties:

First. All comparisons and verifications of the new prototypes of the meter and kilogram.

Second. The custody of the international prototypes.

Third. The periodical comparison of the national standards with the international prototypes and with their test copies, as well as comparisons of the standard thermometers.

Fourth. The comparison of the prototypes with the fundamental standards of nonmetrical weights and measures used in different countries for scientific purposes.

Fifth. The sealing and comparison of geodesic measuring bars.

Sixth. The comparison of standards and scales of precision,

the verification of which may be requested by governments or by scientific societies, or even by constructors or men of science.

**Art. 7.** After the committee shall have proceeded with the work of coordinating the measures relative to electric units and when the general conference shall have so decided by a unanimous vote, the bureau will have charge of the establishment and keeping of the standards of the electric units and their test copies and also of comparing with those standards, the national or other standards of precision.

The bureau is also charged with the duty of making the determinations relative to physical constants, a more accurate knowledge of which may be useful in increasing precision and further insuring uniformity in the provinces to which the above-mentioned units belong (article 6 and first paragraph of article 7).

It is finally charged with the duty of coordinating similar determinations effected in other institutions.

**Art. 8.** The international prototypes and standards and also their test copies shall be deposited in the bureau; access to the deposit shall be solely reserved for the international committee.

**Art. 9.** The entire expense of the construction and outfit of the international bureau of weights and measures, together with the annual cost of its maintenance and the expenses of the committee, shall be defrayed by contributions from the contracting states, the amount of which shall be computed in proportion to the actual population of each.

**Art. 10.** The amounts representing the contributions of each of the contracting States shall be paid at the beginning of each year, through the ministry of foreign affairs of France, into the *Caisse de dépôts et consignations* at Paris, whence they may be drawn as occasion may require, upon the order of the director of the bureau.

**Art. 11.** Those Governments which may take advantage of the privilege, open to every State, of acceding to this convention shall be required to pay a contribution, the amount of which shall be fixed by the committee on the basis established in article 9, and which shall be devoted to the improvement of the scientific apparatus of the bureau.

**Art. 12.** The high contracting parties reserve to themselves the power of introducing into the present convention, by common consent, any modifications the propriety of which may have been shown by experience.

**Art. 13.** At the expiration of twelve years this convention may be abrogated by any one of the high contracting parties, so far as it is concerned.

Any Government which may avail itself of the right of terminating this convention, so far as it is concerned, shall be required to give notice of its intentions one year in advance, and by so doing shall renounce all rights of joint ownership in the international prototypes and in the bureau. • • •

#### Appendix No. 1, Regulations.

**Article 1.** The international bureau of weights and measures shall be established in a special building, possessing all the necessary safeguards of stillness and stability.

It shall comprise, in addition to the vault, which shall be devoted to the safe-keeping of the prototypes, rooms for mounting the comparators and balances; a laboratory, a library, a room for the archives, workrooms for the employés, and lodgings for the watchmen and attendants.

**Art. 2.** It shall be the duty of the international committee to acquire and fit up the aforesaid building and to set in operation the work for which it was designed.

In case of the committee's inability to obtain a suitable

\*Schwartz, K. M., *Federal and State Weights and Measures Laws*, "Metric Convention—1875," *Nat. Bur. Stand. (U.S.) Circular 501*, pp. 3-5 (USGPO, December 1951).



## Federal and State Weights and Measures Laws

building one shall be built under its directions and in accordance with its plans.

*Art. 3.* The French Government shall, at the request of the international committee, take the necessary measures to cause the bureau to be recognized as an establishment of public utility.

*Art. 4.* The international committee shall cause the necessary instruments to be constructed, such as comparators for the standards of line and end measures, apparatus for the determination of absolute dilatations, balances for weighing in air and in vacuo, comparators for geodetic measuring bars, etc.

*Art. 5.* The entire expense incurred in the purchase or construction of the building, and in the purchase and placing of the instruments and apparatus, shall not exceed 400,000 francs.

*Art. 6.* The annual appropriation for the international bureau consists of two parts, one of which is fixed, the other complementary.

The fixed part is, in principle, 250,000 francs, but on the unanimous vote of the committee may be raised to 300,000 francs. It is borne by all the States and autonomous colonies that adhered to the meter convention before the sixth general conference.

The complementary part is made up of contributions from the States and autonomous colonies that joined the convention after the aforesaid general conference. The committee is charged with the duty of drawing up on the motion of the director the annual budget, but without exceeding the amount computed in accordance with the provisions of the two paragraphs above. The budget is made known every year by means of a special financial report to the Governments of the high contracting parties.

If the committee find it necessary either to increase beyond 300,000 francs the fixed part of the annual appropriation or to modify the computation of the contributions as determined by article 20 of these regulations, it should lay the matter before the Governments so as to enable them to issue in good time the needed instructions to their delegates to the next general conference in order that the said conference may deliberate to good purpose. The decision will stand only in the case that no opposition shall have been expressed before or in the conference by any of the contracting States.

If the State should let three years go without paying its contribution, that contribution shall be divided among the other States proportionally to their own contribution. The additional sum thus paid by the States to make up the whole of the appropriation of the bureau shall be regarded as an advance to the delinquent State and shall be reimbursed to them if that State should make good its arrears. The advantages and prerogatives conferred by adhering to the meter convention are suspended in the case of States that have been delinquent three years.

After three more years the delinquent State shall be expelled from the convention and the reckoning of the contributions restored in accordance with the provisions of article 20 of these regulations.

*Art. 7.* The general conference mentioned in article 3 of this convention shall be at Paris, upon the summons of the international committee, at least once every six years.

It shall be its duty to discuss and initiate measures necessary for the dissemination and improvement of the metrical system, and to pass upon such new fundamental metrological determinations as may have been made during the time when it was not in session. It shall receive the report of the international committee concerning the work that has been accomplished, and shall replace one-half of the international committee by secret ballot.

The voting in the general conference shall be by States; each State shall be entitled to one vote.

Each of the members of the international committee shall be entitled to a seat at the meetings of the conference. They may at the same time be delegates of their Governments.

*Art. 8.* The international committee mentioned at article 3 of the convention shall be composed of 18 members all from different States.

At the time of the renewal by halves of the international committee the outgoing members shall be first those who may have been provisionally elected to fill vacancies between two sessions of the conference; the others will be drawn by lot. Outgoing members may be reelected.

*Art. 9.* The international committee organizes itself by electing by its own secret vote its chairman and secretary. Those appointments are notified to the Governments of the high contracting parties.

The chairman and the secretary of the committee and the director of the bureau must belong to different countries.

Once organized, the committee can not hold other elections or make other appointments until three months shall have elapsed after the notice of a vacancy calling for a vote shall have been given to all the members.

*Art. 10.* The international committee directs all the metrological works that the high contracting parties shall decide to have carried on jointly.

It is also charged with the duty of seeing to the conservation of the international prototypes and standards.

It may, lastly, institute the cooperation of specialists in questions of metrology and coordinate the results of their work.

*Art. 11.* The committee shall meet at least once in two years.

*Art. 12.* The balloting in the committee is by a majority vote; in case of a tie vote the chairman has the casting vote.

Decisions are only valid if the members present are at least one half of the elected members forming the committee.

Subject to that condition absent members have a right to delegate their votes to present members who must prove that they have been so delegated. This also applies to appointments by secret ballot.

The director of the bureau is a nonvoting member of the committee.

*Art. 13.* During the interval occurring between two sessions the committee shall have the right to discuss questions by correspondence.

In such cases, in order that its resolutions may be considered to have been adopted in due form, it shall be necessary for all the members of the committee to have been called upon to express their opinions.

*Art. 14.* The international committee for weights and measures shall provisionally fill such vacancies as may occur in it; these elections shall take place by correspondence, each of the members being called upon to take part therein.

*Art. 15.* The international committee will draw up a detailed set of regulations for the organization and work of the bureau and will fix the dues to be paid for the extraordinary works provided by articles 6 and 7 of the convention.

Those dues will be applied to improving the scientific equipment of the bureau. A certain amount may be drawn annually for the retirement fund from the total dues collected by the bureau.

*Art. 16.* All communications from the international committee to the Governments of the high contracting parties shall take place through the diplomatic representatives of such countries at Paris.

For all matters requiring the attention of the French authorities, the committees shall have recourse to the ministry of foreign affairs of France.

*Art. 17.* A regulation drawn up by the committee will determine the maximum staff for each category of the personnel of the bureau. The director and his assistants shall be elected by secret ballot by the international committee. Other appointments shall be notified to the Governments of the high contracting parties. The director will appoint the other members of the personnel within the bounds laid by the regulation mentioned in the first paragraph above.

*Art. 18.* The director of the bureau shall have access to the place where the international prototypes are deposited only in pursuance of a resolution of the committee and in the presence of at least one of its members. The place of deposit of the prototype shall be opened only by means of three keys, one of which shall be in the possession of the director of archives

## Introduction

of France, the second in that of the chairman of the committee, and the third in that of the director of the bureau.

The standards of the class of national prototypes alone shall be used for the ordinary comparing work of the bureau.

*Art. 19.* The director of the bureau shall annually furnish to the committee: First, a financial report concerning the accounts of the preceding year, which shall be examined, and if found correct, a certificate to that effect shall be given him; second, a report on the condition of the apparatus; third, a general report concerning the work accomplished during the course of the year just closed.

The international committee shall make to each of the Governments of the high contracting parties an annual report concerning all its scientific, technical, and administrative operations, and concerning those of the bureau. The chairman of the committee shall make a report to the general conference concerning the work that has been accomplished since its last session.

The reports and publications of the committee shall be in the French language. They shall be printed and furnished to the Governments of the high contracting parties.

*Art. 20.* The scale of contributions spoken of in article 9 of the convention is established for its fixed part on the basis of the appropriation referred to in article 6 of the present regulations and of the population; the normal contribution of each State can not be less than five to a thousand nor more than 15 per cent of the whole appropriation, regardless of the population. In order to establish that scale, it shall first be found which are the States that are in the conditions required for the minimum and maximum and the remainder of the quota shall be distributed among the other States in the direct ratio of their population.

The quota thus reckoned stands for the whole time included between two consecutive general conferences and can only be modified in the meanwhile in the following cases:

(a) If one of the adhering States allows three successive years to pass without making its payments;

(b) When, on the contrary, a State which had been previously delinquent for more than three years pays up its arrears, and the occasion arises to return to the other Governments the advances made by them.

The complementary contribution is computed on the same basis of population and is like that which the States that have long belonged to the convention pay under the same conditions.

If after adhering to the convention a State declares it would like to extend the benefits thereof to one or more of its colonies that are not autonomous, the number of the population of the said colonies would be added to that of the State in reckoning the scale of contributions.

When a colony that is recognized as autonomous shall desire to adhere to the convention, it will be regarded with respect to its admission into the convention and as the mother country may decide, either as a dependency of that mother country or as a contracting State.

*Art. 21.* The expense of constructing the international prototypes and the standards and test copies which are to accompany them shall be defrayed by the high contracting parties in accordance with the scale fixed in the foregoing article.

The amounts to be paid for the comparison and verification of standards required by States not represented at this convention shall be regulated by the committee in conformity with the rates fixed in virtue of article 15 of the regulations.

*Art. 22.* These regulations shall have the same force and value as the convention to which they are annexed. • • •

On January 2, 1890, "meter No. 27" and "kilogram No. 20", being copies of the international prototype meter and kilogram preserved at the International Bureau of Weights and Measures, were opened at the White House and accepted by President Harrison as national standards. Duplicates of these, being "meter No. 21" and "kilogram No. 4", were received later in the same year. These standards were

given into the custody of the Office of Standard Weights and Measures of the Coast and Geodetic Survey of the Treasury Department.

In 1893 a ruling of fundamental importance with respect to standards was made by T. C. Mendenhall, the Superintendent of Standard Weights and Measures. This ruling, which subsequently came to be known as the "Mendenhall Order", was approved April 5, 1893, by the Secretary of the Treasury; its essential part is as follows:

Bulletin No. 26, "Fundamental Standards of Length and Mass", United States Coast and Geodetic Survey, Treasury Department, April 5, 1893.

• • • the Office of Weights and Measures, with the approval of the Secretary of the Treasury, will in the future, regard the International Prototype Metre and Kilogramme as fundamental standards, and the customary units, the yard and the pound, will be derived therefrom in accordance with the Act of July 28, 1866. • • •

Bulletin No. 26 also carried a "Note", as follows:

NOTE.—Reference to the Act of 1866, results in the establishment of the following:

*Equations*

$$1 \text{ yard} = \frac{3600}{3937} \text{ metre.}$$

$$1 \text{ pound avoirdupois} = \frac{1}{2.2046} \text{ kilo.}$$

A more precise value of the English pound avoirdupois is

$$\frac{1}{2.20462} \text{ kilo.,}$$

differing from the above by about one part in one hundred thousand, but the equation established by law is sufficiently accurate for all ordinary conversions.

As already stated, in work of high precision the kilogramme is now all but universally used and no conversion is required.

The National Bureau of Standards continues to consider the relation

$$1 \text{ yard} = \frac{3600}{3937} \text{ meter}$$

which may also be expressed

$$1 \text{ meter} = 39.37 \text{ inches}$$

as an exact equivalent. In the case of the relation between the avoirdupois pound and the kilogram, however, the National Bureau of Standards now recognizes as the fundamental relation

$$1 \text{ avoirdupois pound} = 0.453\,592\,427\,7 \text{ kilogram}$$

which corresponds with

$$1 \text{ kilogram} = 2.204\,622\,341 \text{ avoirdupois pounds.}$$

## ANNEX 11.G.

### LEGAL DOCUMENTS CONCERNING “STANDARD TIME”

#### Contents

	Page
11.G.1. “Uniform Time Act” — <i>Public Law 89-387</i> , 89th Congress S. 1404, April 13, 1966...	391
11.G.2. “Standard Time,” <i>U.S. Code, Title 15</i> , 3, Chap. 6. sec. 260-267, pp. 3228-3231, 1970 Edition (USGPO, 1971).....	394
11.G.3. “Standard Time Zone Boundaries,” <i>Code of Federal Regulations</i> , Title 49—Transportation, Subtitle A, Part 71, issued July 31, 1970, pp. 83-90 (USGPO, January 1, 1972).....	398
11.G.4. “Standard Time Zone Boundaries—Relocation of Eastern-Central Time Zone Boundary in the State of Michigan,” <i>Federal Register</i> , Title 49—Transportation, Subtitle A, Part 71, <b>38</b> , No. 70, pp. 9228-9229 (April 12, 1973) .....	406
11.G.5. “Emergency Daylight Saving Time—Procedures and Criteria for Implementation,” <i>Federal Register</i> , <b>38</b> , Title 49—Transportation, Subtitle A, Part 73, No. 244, pp. 34876-34878 (December 20, 1973)—Added in proof.....	408
11.G.5.a. “Emergency Daylight Saving Time”—DOT exemption and realignment to Certain States, <i>Federal Register</i> , <b>39</b> , No. 7 (Transportation), pp. 1524-1526 (January 10, 1974)—Added in proof.....	411

# ANNEX 11.G.1.



Public Law 89-387  
89th Congress, S. 1404  
April 13, 1966

## An Act

To promote the observance of a uniform system of time throughout the United States.

*Be it enacted by the Senate and House of Representatives of the United States of America in Congress assembled, That this Act may be cited as the "Uniform Time Act of 1966".*

Uniform Time  
Act of 1966.

Sec. 2. It is the policy of the United States to promote the adoption and observance of uniform time within the standard time zones prescribed by the Act entitled "An Act to save daylight and to provide standard time for the United States", approved March 19, 1918 (40 Stat. 450; 15 U.S.C. 261-264), as modified by the Act entitled "An Act to transfer the Panhandle and Plains section of Texas and Oklahoma to the United States standard central time zone", approved March 4, 1921 (41 Stat. 1446; 15 U.S.C. 265). To this end the Interstate Commerce Commission is authorized and directed to foster and promote widespread and uniform adoption and observance of the same standard of time within and throughout each such standard time zone.

Sec. 3. (a) During the period commencing at 2 o'clock antemeridian on the last Sunday of April of each year and ending at 2 o'clock antemeridian on the last Sunday of October of each year, the standard time of each zone established by the Act of March 19, 1918 (15 U.S.C. 261-264), as modified by the Act of March 4, 1921 (15 U.S.C. 265), shall be advanced one hour and such time as so advanced shall for the purposes of such Act of March 19, 1918, as so modified, be the standard time of such zone during such period; except that any State may by law exempt itself from the provisions of this subsection providing for the advancement of time, but only if such law provides that the entire State (including all political subdivisions thereof) shall observe the standard time otherwise applicable under such Act of March 19, 1918, as so modified, during such period.

(b) It is hereby declared that it is the express intent of Congress by this section to supersede any and all laws of the States or political subdivisions thereof insofar as they may now or hereafter provide for advances in time or changeover dates different from those specified in this section.

(c) For any violation of the provisions of this section the Interstate Commerce Commission or its duly authorized agent may apply to the district court of the United States for the district in which such violation occurs for the enforcement of this section; and such court shall have jurisdiction to enforce obedience thereto by writ of injunction or by other process, mandatory or otherwise, restraining against further violations of this section and enjoining obedience thereto.

Violations.

80 STAT. 107.  
80 STAT. 108.

Sec. 4. (a) The first section of the Act of March 19, 1918, as amended (15 U.S.C. 261), is amended to read as follows:

Standard time  
zones.

"That for the purpose of establishing the standard time of the United States, the territory of the United States shall be divided into eight zones in the manner provided in this section. Except as provided in section 3(a) of the Uniform Time Act of 1966, the standard time of the first zone shall be based on the mean solar time of the

sixtieth degree of longitude west from Greenwich; that of the second zone on the seventy-fifth degree; that of the third zone on the ninetieth degree; that of the fourth zone on the one hundred and fifth degree; that of the fifth zone on the one hundred and twentieth degree; that of the sixth zone on the one hundred and thirty-fifth degree; that of the seventh zone on the one hundred and fiftieth degree; and that of the eighth zone on the one hundred and sixty-fifth degree. The limits of each zone shall be defined by an order of the Interstate Commerce Commission, having regard for the convenience of commerce and the existing junction points and division points of common carriers engaged in interstate or foreign commerce, and any such order may be modified from time to time. As used in this Act, the term 'inter-

"Interstate or foreign commerce." state or foreign commerce' means commerce between a State, the District of Columbia, the Commonwealth of Puerto Rico, or any possession of the United States and any place outside thereof."

15 USC 262. (b) Section 2 of such Act is amended to read as follows:  
 "Sec. 2. Within the respective zones created under the authority of this Act the standard time of the zone shall insofar as practicable (as determined by the Interstate Commerce Commission) govern the movement of all common carriers engaged in interstate or foreign commerce. In all statutes, orders, rules, and regulations relating to the time of performance of any act by any officer or department of the United States, whether in the legislative, executive, or judicial branches of the Government, or relating to the time within which any rights shall accrue or determine, or within which any act shall or shall not be performed by any person subject to the jurisdiction of the United States, it shall be understood and intended that the time shall insofar as practicable (as determined by the Interstate Commerce Commission) be the United States standard time of the zone within which the act is to be performed."

Designations. (c) Section 4 of such Act is amended to read as follows:  
 "Sec. 4. The standard time of the first zone shall be known and designated as Atlantic standard time; that of the second zone shall be known and designated as eastern standard time; that of the third zone shall be known and designated as central standard time; that of the fourth zone shall be known and designated as mountain standard time; that of the fifth zone shall be known and designated as Pacific standard time; that of the sixth zone shall be known and designated as Yukon standard time; that of the seventh zone shall be known and designated as Alaska-Hawaii standard time; and that of the eighth zone shall be known and designated as Bering standard time."

60 Stat. 237. Sec. 5. The Administrative Procedure Act (5 U.S.C. 1001-1011) shall apply to all proceedings under this Act, the Act of March 19, 1918 (15 U.S.C. 261-264), and the Act of March 4, 1921 (15 U.S.C. 265).

Effective date. Sec. 6. This Act shall take effect on April 1, 1967; except that if any State, the District of Columbia, the Commonwealth of Puerto Rico, or any possession of the United States, or any political subdivision thereof, observes daylight saving time in the year 1966, such time shall advance the standard time otherwise applicable in such place by one hour and shall commence at 2 o'clock antemeridian on the last

Sunday in April of the year 1966 and shall end at 2 o'clock ante-meridian on the last Sunday in October of the year 1966.

SEC. 7. As used in this Act, the term "State" includes the District "State," of Columbia, the Commonwealth of Puerto Rico, or any possession of the United States.

Approved April 13, 1966.

---

LEGISLATIVE HISTORY:

HOUSE REPORTS: No. 1315 accompanying H. R. 6785 (Comm. on Interstate & Foreign Commerce) and No. 1385 (Comm. of Conference).

SENATE REPORT No. 268 (Comm. on Commerce).

CONGRESSIONAL RECORD:

Vol. 111 (1965): June 3, considered and passed Senate.  
Vol. 112 (1966): Mar. 16, considered and passed House, amended, in lieu of H. R. 6785.  
Mar. 22, Senate concurred in House amendment with amendments.  
Mar. 29, Senate agreed to conference report.  
Mar. 30, House agreed to conference report.

## ANNEX 11.G.2.

### STANDARD TIME \*

§ 260. Congressional declaration of policy; adoption and observance of uniform standard of time; authority of Secretary of Transportation.

It is the policy of the United States to promote the adoption and observance of uniform time within the standard time zones prescribed by sections 261 to 264 of this title, as modified by section 265 of this title. To this end the Secretary of Transportation is authorized and directed to foster and promote widespread and uniform adoption and observance of the same standard of time within and throughout each such standard time zone. (Pub. L. 89-387, § 2, Apr. 13, 1966, 80 Stat. 107.)

#### EFFECTIVE DATE

Section 6 of Pub. L. 89-387 provided that: "This Act [which enacted sections 260, 260a, 266, and 267 of this title and amended sections 261-263 of this title] shall take effect on April 1, 1967; except that if any State, the District of Columbia, the Commonwealth of Puerto Rico, or any possession of the United States, or any political subdivision thereof, observes daylight saving time in the year 1966, such time shall advance the standard time otherwise applicable in such place by one hour and shall commence at 2 o'clock antemeridian on the last Sunday in April of the year 1966 and shall end at 2 o'clock antemeridian on the last Sunday in October of the year 1966."

#### SHORT TITLE

Section 1 of Pub. L. 89-387 provided: "That this Act [which enacted sections 260, 260a, 266, and 267 of this title, and amended sections 261-263 of this title, and enacted provisions set out as notes under this section] may be cited as the 'Uniform Time Act of 1966'."

#### TRANSFER OF FUNCTIONS

Reference to the Interstate Commerce Commission was changed to the Secretary of Transportation pursuant to Pub. L. 89-670, Oct. 15, 1966, 80 Stat. 931, which created the Department of Transportation and vested all powers, duties and functions of the Interstate Commerce Commission and of the Chairman, members, offices, and officers thereof relating generally to standard time zones and daylight savings time under this section in the Secretary of Transportation. See section 1655(e)(5) of Title 49, Transportation.

#### SECTION REFERRED TO IN OTHER SECTIONS

This section is referred to in sections 266, 267 of this title.

\*Committee on Judiciary of House of Representatives, *United States Code: 1970 Edition*, Title 15, §, Chap. 6, "Weights and Measures and Standard Time," sec. 260-267, pp. 3228-3231 (USGPO, 1971).

§ 260a. Advancement of time or changeover dates.

(a) Duration of period; State exemption.

During the period commencing at 2 o'clock antemeridian on the last Sunday of April of each year and ending at 2 o'clock antemeridian on the last Sunday of October of each year, the standard time of each zone established by sections 261 to 264 of this title, as modified by section 265 of this title, shall be advanced one hour and such time as so advanced shall for the purposes of such sections 261 to 264, as so modified, be the standard time of such zone during such period; except that any State may by law exempt itself from the provisions of this subsection providing for the advancement of time, but only if such law provides that the entire State (including all political subdivisions thereof) shall observe the standard time otherwise applicable under such sections 261 to 264, as so modified during such period.

(b) State laws superseded.

It is hereby declared that it is the express intent of Congress by this section to supersede any and all laws of the States or political subdivisions thereof insofar as they may now or hereafter provide for advances in time or changeover dates different from those specified in this section.

(c) Violations; enforcement.

For any violation of the provisions of this section the Secretary of Transportation or his duly authorized agent may apply to the district court of the United States for the district in which such violation occurs for the enforcement of this section; and such court shall have jurisdiction to enforce obedience thereto by writ of injunction or by other process, mandatory or otherwise, restraining against further violations of this section and enjoining obedience thereto. (Pub. L. 89-387, § 3, Apr. 13, 1966, 80 Stat. 107.)

TRANSFER OF FUNCTIONS

Reference to the Interstate Commerce Commission was changed to the Secretary of Transportation pursuant to Pub. L. 89-670, Oct. 15, 1966, 80 Stat. 931, which created the Department of Transportation and vested all powers, duties and functions of the Interstate Commerce Commission and of the Chairman, members, offices, and officers thereof relating generally to standard time zones and daylight savings time under this section in the Secretary of Transportation. See section 1655(e)(5) of Title 49, Transportation.

SECTION REFERRED TO IN OTHER SECTIONS

This section is referred to in section 261 of this title.

§ 261. Zones for standard time; interstate or foreign commerce.

For the purpose of establishing the standard time of the United States, the territory of the United States shall be divided into eight zones in the manner provided in this section. Except as provided in section 260a(a) of this title, the standard time of the first zone shall be based on the mean solar time of the sixtieth degree of longitude west from Greenwich; that of the second zone on the seventy-fifth degree; that of the third zone on the ninetieth degree; that of the fourth zone on the one hundred and fifth degree; that of the fifth zone on the one hundred and twentieth degree; that of the sixth zone on the one hundred and thirty-fifth degree; that of

the seventh zone on the one hundred and fiftieth degree; and that of the eighth zone on the one hundred and sixty-fifth degree. The limits of each zone shall be defined by an order of the Secretary of Transportation, having regard for the convenience of commerce and the existing junction points and division points of common carriers engaged in interstate or foreign commerce, and any such order may be modified from time to time. As used in sections 261-264 of this title, the term "interstate or foreign commerce" means commerce between a State, the District of Columbia, the Commonwealth of Puerto Rico, or any possession of the United States and any place outside thereof. (Mar. 19, 1918, ch. 24, § 1, 40 Stat. 450; Apr. 13, 1966, Pub. L. 89-387, § 4(a), 80 Stat. 108.)

AMENDMENTS

1966—Pub. L. 89-387 increased the number of time zones from five for the territory of continental United States to eight for the territory of the United States, inserted the "exception phrase", substituted "solar" for "astronomical" time, established the first zone on basis of the 60th degree of longitude west from Greenwich, redesignated as the second through the fifth zones based on the 75th, 90th, 105th, and 120th degrees former zones one through four based on such degrees, established the sixth zone based on the 135th degree, redesignated as the seventh zone based on the 150th degree former fifth zone based on such degree, and established the eighth zone based on the 165th degree, substituted "interstate or foreign commerce" for "commerce between the several States and and with foreign nations" and defined "interstate or foreign commerce."

REPEALS

Section 5 of act Mar. 19, 1918, repealed all conflicting acts and parts of acts.

DISTRICT OF COLUMBIA

Act March 31, 1949, ch. 43, 63 Stat. 29, authorized the Board of Commissioners [now the District of Columbia Council] to establish daylight-saving time in the District of Columbia.

RETURN TO STANDARD TIME

Act Sept. 25, 1945, ch. 388, 59 Stat. 537, provided, that, notwithstanding the provisions of act Jan. 20, 1942, ch. 7, 56 Stat. 9, which provided for war time, the standard time for each zone as provided for in sections 261-264 of this title should again become effective as of Sept. 30, 1945, at 2:00 A. M.

TRANSFER OF FUNCTIONS

Reference to the Interstate Commerce Commission was changed to the Secretary of Transportation pursuant to Pub. L. 89-670, Oct. 15, 1966, 80 Stat. 931, which created the Department of Transportation and vested all powers, duties and functions of the Interstate Commerce Commission and of the Chairman, members, offices, and officers thereof relating generally to standard time zones and daylight savings time under this section in the Secretary of Transportation. See section 1655(a)(5) of Title 49, Transportation.

SECTION REFERRED TO IN OTHER SECTIONS

This section is referred to in sections 260, 260a, 262, 266, 267 of this title.

§ 262. Duty to observe standard time of zones.

Within the respective zones created under the authority of sections 261 to 264 of this title the standard time of the zone shall insofar as practicable (as determined by the Secretary of Transportation) govern the movement of all common carriers engaged in interstate or foreign commerce. In all statutes, orders, rules, and regulations relating to the time of performance of any act by any officer or department of the United States, whether in the



legislative, executive, or judicial branches of the Government, or relating to the time within which any rights shall accrue or determine, or within which any act shall or shall not be performed by any person subject to the jurisdiction of the United States, it shall be understood and intended that the time shall insofar as practicable (as determined by the Secretary of Transportation) be the United States standard time of the zone within which the act is to be performed. (Mar. 19, 1918, ch. 24, § 2, 40 Stat. 451; Apr. 13, 1966, Pub. L. 89-387, § 4(b), 80 Stat. 108.)

#### AMENDMENTS

1966—Pub. L. 89-387 inserted "insofar as practicable (as determined by the Interstate Commerce Commission)" in two instances and substituted "engaged in interstate or foreign commerce" for "engaged in commerce between the several States or between a State and any one of the Territories of the United States, or between a State or the Territory of Alaska and any one of the insular possessions of the United States or any foreign country".

#### TRANSFER OF FUNCTIONS

Reference to the Interstate Commerce Commission was changed to the Secretary of Transportation pursuant to Pub. L. 89-870, Oct. 15, 1966, 80 Stat. 931, which created the Department of Transportation and vested all powers, duties and functions of the Interstate Commerce Commission and of the Chairman, members, offices, and officers thereof relating generally to standard time zones and daylight savings time under this section in the Secretary of Transportation. See section 1655(e)(5) of Title 49, Transportation.

#### SECTION REFERRED TO IN OTHER SECTIONS

This section is referred to in sections 260, 260a, 261, 266, 267 of this title.

#### § 263. Designation of zone standard times.

The standard time of the first zone shall be known and designated as Atlantic standard time; that of the second zone shall be known and designated as eastern standard time; that of the third zone shall be known and designated as central standard time; that of the fourth zone shall be known and designated as mountain standard time; that of the fifth zone shall be known and designated as Pacific standard time; that of the sixth zone shall be known and designated as Yukon standard time; that of the seventh zone shall be known and designated as Alaska-Hawaii standard time; and that of the eighth zone shall be known and designated as Bering standard time. (Mar. 19, 1918, ch. 24, § 4, 40 Stat. 451; Apr. 13, 1966, Pub. L. 89-387, § 4(c), 80 Stat. 108.)

#### AMENDMENTS

1966—Pub. L. 89-387 added Atlantic standard time as first zone designation; redesignated as eastern standard time, central standard time, mountain standard time and Pacific standard time for second through fifth zones former designation of United States standard eastern time, United States standard central time, United States standard mountain time and United States standard Pacific time for former zones one through four; added Yukon standard time as sixth zone designation; redesignated as Alaska-Hawaii standard time for seventh zone former designation of United States standard Alaska time for fifth zone; and added Bering standard time as eighth zone designation.

#### TRANSFER OF FUNCTIONS

All functions, powers, and duties of this Interstate Commerce Commission and the Chairman, members, offices, and officers thereof relating generally to standard

time zones and daylight savings time under this section were transferred to and vested in the Secretary of Transportation by Pub. L. 89-870, Oct. 15, 1966, 80 Stat. 931, which created the Department of Transportation. See section 1655(e)(5) of Title 49, Transportation.

#### SECTION REFERRED TO IN OTHER SECTIONS

This section is referred to in sections 260, 260a, 261, 262, 266, 267 of this title.

#### § 264. Part of Idaho in third zone.

In the division of territory, and in the definition of the limits of each zone, as provided in sections 261 to 264 of this title, so much of the State of Idaho as lies south of the Salmon River, traversing the State from east to west near forty-five degree thirty minutes latitude, shall be embraced in the third zone: *Provided*, That common carriers within such portion of the State of Idaho may conduct their operations on Pacific time. (Mar. 19, 1918, ch. 24, § 3, as added Mar. 3, 1923, ch. 216, 42 Stat. 1434, and amended June 24, 1948, ch. 631, § 1, 62 Stat. 646.)

#### AMENDMENTS

1948—Act June 24, 1948, added proviso relating to common carriers.

#### EFFECTIVE DATE OF 1948 AMENDMENT

Section 2 of act June 24, 1948, provided that: "This Act [act June 24, 1948] shall take effect at 2 o'clock antemeridian of the second Monday following the date of its enactment [June 24, 1948]."

#### REPEALS

The original section 3 of act Mar. 19, 1918, providing for daylight-savings, was repealed by act Aug. 20, 1919, ch. 51, 41 Stat. 280.

#### TRANSFER OF FUNCTIONS

All functions, powers, and duties of the Interstate Commerce Commission and the Chairman, members, offices, and officers thereof relating generally to standard time zones and daylight savings time under this section were transferred to and vested in the Secretary of Transportation by Pub. L. 89-870, Oct. 15, 1966, 80 Stat. 931, which created the Department of Transportation. See section 1655(e)(5) of Title 49, Transportation.

#### SECTION REFERRED TO IN OTHER SECTIONS

This section is referred to in sections 260, 260a, 261, 262, 266 of this title.

#### § 265. Transfer of certain territory to standard central-time zone.

The Panhandle and Plains sections of Texas and Oklahoma are transferred to and placed within the United States standard central-time zone.

The Secretary of Transportation is authorized and directed to issue an order placing the western boundary line of the United States standard central-time zone insofar as the same affect Texas and Oklahoma as follows:

Beginning at a point where such western boundary time zone line crosses the State boundary line between Kansas and Oklahoma; thence westerly along said State boundary line to the northwest corner of the State of Oklahoma; thence in a southerly direction along the west State boundary line of Oklahoma and the west State boundary line of Texas to the southeastern corner of the State of New Mexico; thence in a westerly direction along the State boundary line between the States of Texas and New Mexico to the Rio Grande River; thence down the Rio Grande River as the boundary line between the United States and Mexico: *Provided*,

That the Chicago, Rock Island and Gulf Railway Company and the Chicago, Rock Island and Pacific Railway Company may use Tucumcari, New Mexico, as the point at which they change from central to mountain time and vice versa; the Colorado Southern and Fort Worth and Denver City Railway Companies may use Sixela, New Mexico, as such changing point; the Atchison, Topeka and Santa Fe Railway Company and other branches of the Santa Fe system may use Clovis, New Mexico, as such changing point, and those railways running into or through El Paso may use El Paso as such point: *Provided further*, That this section shall not, except as herein provided, interfere with the adjustment of time zones as established by the Secretary of Transportation. (Mar. 4, 1921, ch. 173, § 1, 41 Stat. 1446.)

#### REPEALS

Section 2 of act Mar. 4, 1921, repealed all conflicting laws and parts of laws.

#### TRANSFER OF FUNCTIONS

Reference to the Interstate Commerce Commission was changed to the Secretary of Transportation pursuant to Pub. L. 89-670, Oct. 15, 1966, 80 Stat. 931, which created the Department of Transportation and vested all powers, duties and functions of the Interstate Commerce Commission and of the Chairman, members, offices, and officers thereof relating generally to standard time zones and daylight savings time under this section in the Secretary of Transportation. See section 1655(e) (5) of Title 49, Transportation.

#### TRANSFER OF EL PASO AND HUDSPETH COUNTIES, TEXAS, TO MOUNTAIN STANDARD TIME ZONE

Pub. L. 91-228, Apr. 10, 1970, 84 Stat. 119, provided: "That, notwithstanding the first section of the Act of March 4, 1921 (15 U.S.C. 265) [this section], the Secretary of Transportation may, upon the written request of the County Commissioners Court of El Paso County, Texas, change the boundary line between the central standard time zone and the mountain standard time zone, so as to place El Paso County in the mountain standard time zone, in the manner prescribed in section 1 of the Act of March 19, 1918, as amended (15 U.S.C. 261), and section 5 of the Act of April 13, 1966 (15 U.S.C. 266). In the same manner, the Secretary of Transportation may also place Hudspeth County, Texas, in the mountain standard time zone, if the Hudspeth County Commissioners Court so requests in writing and if El Paso County is to be placed in that time zone."

#### SECTION REFERRED TO IN OTHER SECTIONS

This section is referred to in sections 260, 260a, 266 of this title.

#### § 266. Applicability of Administrative Procedure Act.

The Administrative Procedure Act shall apply to all proceedings under sections 260 to 267 of this title. (Pub. L. 89-387, § 5, Apr. 13, 1966, 80 Stat. 108.)

#### REFERENCES IN TEXT

The Administrative Procedure Act, referred to in text, is classified to sections 551 et seq. and 701 et seq. of Title 5, Government Organization and Employees.

#### CODIFICATION

"Sections 260 to 267 of this title" read in the original "this Act [meaning Pub. L. 89-387], the Act of March 19, 1918 (15 U.S.C. 261-264), and the Act of March 4, 1921 (15 U.S.C. 265)", which are classified to sections 260-263, 266, 267; 261-264; and 265 of this title, respectively,

#### TRANSFER OF FUNCTIONS

All functions, powers, and duties of the Interstate Commerce Commission and the Chairman, members, offices, and officers thereof relating generally to standards time zones and daylight savings time under this section

were transferred to and vested in the Secretary of Transportation by Pub. L. 89-670, Oct. 15, 1966, 80 Stat. 931, which created the Department of Transportation. See section 1655(e) (5) of Title 49, Transportation.

#### SECTION REFERRED TO IN OTHER SECTIONS

This section is referred to in section 267 of this title.

#### § 267. State defined.

As used in sections 260 to 263, 266 and 267 of this title, the term "State" includes the District of Columbia, the Commonwealth of Puerto Rico, or any possession of the United States. (Pub. L. 89-387, § 7, Apr. 13, 1966, 80 Stat. 109.)

#### TRANSFER OF FUNCTIONS

All functions, powers, and duties of the Interstate Commerce Commission and the Chairman, members, offices, and officers thereof relating generally to standard time zones and daylight savings time under this section were transferred to and vested in the Secretary of Transportation by Pub. L. 89-670, Oct. 15, 1966, 80 Stat. 931, which created the Department of Transportation. See section 1655(e) (5) of Title 49, Transportation.

#### SECTION REFERRED TO IN OTHER SECTIONS

This section is referred to in section 266 of this title.

## ANNEX 11.G.3.

### PART 71—STANDARD TIME ZONE BOUNDARIES \*

- Sec.
- 71.1 Limits defined; exceptions authorized for certain rail operating purposes only.
  - 71.2 Annual advancement of standard time.
  - 71.3 Atlantic zone.
  - 71.4 Eastern zone.
  - 71.5 Boundary line between eastern and central zones.
  - 71.6 Central zone.
  - 71.7 Boundary line between central and mountain zones.
  - 71.8 Mountain zone.
  - 71.9 Boundary line between mountain and Pacific zones.
  - 71.10 Pacific zone.
  - 71.11 Yukon zone.
  - 71.12 Alaska-Hawaii zone.
  - 71.13 Bering zone.

**AUTHORITY:** The provisions of this Part 71 issued under secs. 1-4, 40 Stat. 450, as amended, sec. 1, 41 Stat. 1446, as amended, secs. 2-7, 80 Stat. 107-109, sec. 6(e)(5), 80 Stat. 937, sec. 1, 84 Stat. 119; 15 U.S.C. 260-267, 49 U.S.C. 1655(e)(5), unless otherwise noted.

**SOURCE:** The provisions of this Part 71 appear at 35 F.R. 12318, Aug. 1, 1970, unless otherwise noted.

§ 71.1 Limits defined; exceptions authorized for certain rail operating purposes only.

(a) This part prescribes the geographic limits of each of the eight standard time zones established by section 1 of the Standard Time Act, as amended by section 4 of the Uniform Time Act of 1966 (15 U.S.C. 261). It also contains lists of operating exceptions granted for specified rail carriers, whose operations cross the time zone boundaries prescribed by this part, authorizing them to carry the standard of time on which the major portion of a particular operation is conducted into an adjoining time zone.

(b) Any rail carrier whose operations cross a time zone boundary prescribed by this part may apply for an operating exception to the General Counsel, Department of Transportation, Washington, D.C. 20590. However, each rail carrier for which an operating exception is granted shall, in its advertisements, time cards, station bulletin boards, and other publications, show arrival and departure times in terms of the standard time for the place concerned.

(c) The time zones established by the Standard Time Act, as amended by the

\*Office of Federal Register, *Code of Federal Regulations*, Title 49 (Transportation) "Part 71—Standard Time Zone Boundaries," pp. 83-90 (USGPO, January 1, 1972).

Uniform Time Act of 1966, are Atlantic, eastern, central, mountain, Pacific, Yukon, Alaska-Hawaii, and Bering.

**§ 71.2 Annual advancement of standard time.**

(a) Section 3(a) of the Uniform Time Act of 1966 (15 U.S.C. 260a(a)) requires that "the standard time of each zone . . . shall be advanced 1 hour [during the period beginning at 2:00 a.m. on the last Sunday in April of each year and ending at 2:00 a.m. on the last Sunday in October] . . . and such time as so advanced shall be the standard time of such zone during such period." The section further authorizes any State to exempt itself from this requirement. For these reasons, all times (including the period of advanced time) in the United States, whether in an exempted State or not, shall be cited as "standard time" during the entire year.

(b) Section 3(b) of the Uniform Time Act of 1966 (15 U.S.C. 260a(b)) provides that "it is the express intent of Congress . . . to supersede any and all laws of the States or political subdivisions thereof insofar as they may now or hereafter provide for advances in time or changeover dates different from those specified in [section 3(a) of that Act]", which are those specified in paragraph (a) of this section.

**§ 71.3 Atlantic zone.**

The first zone, the Atlantic standard time zone, includes that part of the United States that is between 52°30' W. longitude and 67°30' W. longitude and that part of the Commonwealth of Puerto Rico that is west of 67°30' W. longitude, but does not include any part of the State of Maine.

**§ 71.4 Eastern zone.**

The second zone, the eastern standard time zone, includes that part of the United States that is west of 67°30' W. longitude and east of the boundary line described in § 71.5, and includes all of the State of Maine, but does not include any part of the Commonwealth of Puerto Rico.

**§ 71.5 Boundary line between eastern and central zones.**

(a) *Minnesota - Michigan - Wisconsin.* From the junction of the western boundary of the State of Michigan with the boundary between the United States and Canada southerly and easterly along the

western boundary of the State of Michigan to a point in the middle of Lake Michigan opposite the main channel of Green Bay; thence southerly along the western boundary of the State of Michigan to its junction with the southern boundary thereof and the northern boundary of the State of Indiana.

(b) *Indiana-Illinois.* From the junction of the western boundary of the State of Michigan with the northern boundary of the State of Indiana easterly along the northern boundary of the State of Indiana to the east line of La Porte County; thence southerly along the east line of La Porte County to the north line of Starke County; thence east along the north line of Starke County to the east line of Starke County; thence south along the east line of Starke County to the south line of Starke County; thence west along the south line of Starke County to the east line of Jasper County; thence south along the east line of Jasper County to the south line of Jasper County; thence west along the south lines of Jasper and Newton Counties to the western boundary of the State of Indiana; thence south along the western boundary of Indiana to the north line of Gibson County; thence east along the north lines of Gibson and Pike Counties to the east line of Pike County; thence south along the east lines of Pike and Warrick Counties to the north line of Warrick County; thence east along the north lines of Warrick and Spencer Counties to the east line of Spencer County; thence south along the east line of Spencer County to the Indiana-Kentucky boundary.

(c) *Kentucky.* From the junction of the east line of Spencer County, Ind., with the Indiana-Kentucky boundary easterly along that boundary to the west line of Meade County, Ky.; thence southeasterly and southwesterly along the west lines of Meade and Hardin Counties to the southwest corner of Hardin County; thence along the south lines of Hardin and Larue Counties to the northwest corner of Taylor County; thence southeasterly along the west (southwest) line of Taylor County and northeasterly along the east (southeast) line of Taylor County to the west line of Casey County; and thence southerly along the west and south lines of Casey, Pulaski, and McCreary Counties to the Kentucky-Tennessee boundary.

(d) *Tennessee.* From the junction of the west line of McCreary County, Ky.,

with the Kentucky-Tennessee boundary westerly along that boundary to the west line of Scott County, Tenn.; thence southerly along the west line of Scott County, the north and west lines of Morgan County, and the north line of Roane County to the north line of Rhea County; thence northwesterly along the north line of Rhea County; and thence southwestly along the west lines of Rhea and Hamilton Counties to the Tennessee-Georgia boundary.

(e) *Georgia-Alabama.* From the junction of the west line of Hamilton County, Tenn., with the Tennessee-Georgia boundary westerly along that boundary to its junction with the Alabama-Georgia boundary; thence southerly along that boundary and the Florida-Georgia boundary to the southwest corner of the State of Georgia.

(f) *Florida.* From the southwest corner of the State of Georgia to the midpoint of the Apalachicola River on the downstream side of Jim Woodruff Dam; thence southerly along the middle of the main channel of the Apalachicola River and Apalachicola Bay to the Gulf of Mexico.

(g) *Operating exceptions—*(1) *Lines east of boundary excepted from eastern zone.* Those parts of the following lines of railroad located east of the zone boundary described in this section, are, for operating purposes only, excepted from the eastern standard time zone and included within the central standard time zone:

Railroad	From—	To—
Baltimore & Ohio.	East line of La Porte County, Ind. (west of Walkerton, Ind.).	West yard limits of Garrett, Ind.
Do.....	Illinois-Indiana State line (west of Dana, Ind.).	West yard limits of Indianapolis, Ind.
Do.....	Illinois-Indiana State line (west of Vincennes, Ind.).	Washington, Ind.
Chicago, Milwaukee, St. Paul & Pacific.	Illinois-Indiana State line (northwest of Dana, Ind.).	Seymour, Ind.
Do.....	Michigan-Wisconsin State line (south of Iron Mountain, Mich.).	Champion, Ontonagon, and Iron River, Mich. <sup>1</sup>
Chicago & Northwestern.	Michigan-Wisconsin State line.	East lines of Marquette and Delta Counties, Mich. <sup>1</sup>
Erie-Lackawanna.	South line of Starke County, Ind. (near Ora, Ind.).	Marion, Ohio.

See footnotes at end of table.

Railroad	From—	To—
Grand Trunk Western.	East line of La Porte County, Ind. (east of Mill Creek).	Michigan-Indiana State line (near Granger, Ind.).
Do.....	Michigan-Indiana State line (near Granger, Ind.).	Battle Creek, Mich. <sup>1</sup>
Illinois Central....	Illinois-Indiana State line (west of Riverton, Ind.).	South yard limits of Indianapolis, Ind.
Do.....	West line of Hardin County, Ky. (west of Summit, Ky.).	Hodgenville, Ky., and south yard limits of Louisville, Ky.
Louisville & Nashville.	West line of Meade County, Ky. (west of Guston, Ky.).	Strawberry, Ky.
Do.....	South line of Hardin County, Ky. (south of Dombey, Ky.).	Lebanon Junction, Ky.
Do.....	West line of Hamilton County, Tenn. (west of Hooker, Ga.).	Western limits of Chattanooga, Tenn.
Do.....	Apalachicola River.	River Junction, Fla.
Norfolk & Western.	East line of Starke County, Ind. (west of Burr Oak, Ind.).	East yard limits of Fort Wayne, Ind.
Do.....	East line of La Porte County, Ind. (east of Dillon, Ind.).	Toledo, Ohio.
Do.....	Illinois-Indiana State line (west of State line, Ind.)	Toledo, Ohio, and Ohio-Michigan State line (near Munson, Mich.).
Do.....	Ohio-Michigan State line (near Munson, Mich.).	Oakwood Junction, Mich. <sup>1</sup>
Do.....	East line of La Porte County, Ind. (west of Walkerton, Ind.).	South yard limits of Peru, Ind.
Do.....	Illinois-Indiana State line (west of Ambia, Ind.).	East yard limits of Frankfort, Ind.
Do.....	Illinois-Indiana State line (west of Cayuga, Ind.).	Frankfort, Ind.
Penn Central.....	Michigan-Indiana State line (south of Grand Beach, Mich.).	Niles, Mich. <sup>1</sup>
Do.....	East line of La Porte County, Ind. (west of Elkhart, Ind.).	Tower B (4.9 miles) east of the west line of Elkhart County, Ind.
Do.....	East line of Starke County, Ind. (west of Donaldson, Ind.).	Fort Wayne, Ind.
Do.....	South line of Starke County, Ind. (north of Denham, Ind.).	Logansport, Ind.
Do.....	East line of Jasper County, Ind. (east of Remington, Ind.).	Logansport, Ind.

Railroad	From—	To—
Penn Central— Continued	The intersection of the north line of Benton County, Ind., and Illinois-Indiana State line (northwest of Sheff, Ind.).	Sheff, Ind.
Do.....	South line of Newton County, Ind. (north of Sheff, Ind.).	Illinois-Indiana State line (northeast of Danville, Ill.)
Do.....	Illinois-Indiana State line (west of St. Marys of the Woods, Ind.).	Ringo Tower, Ind. (Terre Haute).
Do.....	Illinois-Indiana State line (east of Farrington, Ill.).	Ringo Tower, Ind. (Terre Haute).
Peoria & Eastern.	Illinois-Indiana State line (east of Danville, Ill.).	West yard limits of Indianapolis, Ind.
Soo Line.....	Michigan-Wisconsin State line.	United States-Canada Boundary (near Sault Ste. Marie, Mich.) <sup>1</sup>
Southern.....	East line of Pike County, Ind. (west of Stapleton, Ind.).	Junction with Baltimore & Ohio near Vincennes Street, New Albany, Ind.

<sup>1</sup> Effective only from 2 a.m. on the last Sunday in October to 2 a.m. on the last Sunday in April; exception unnecessary during the remainder of year because during that period Michigan time is not advanced and therefore is the same as central standard time (advanced).

(2) *Lines west of boundary included in eastern zone.* Those parts of the following lines of railroad located west of the zone boundary line described in this section, are, for operating purposes only, excepted from the central time zone and included within the eastern standard time zone:

Railroad	From—	To—
Apalachicola Northern.	Apalachicola, Fla., and Apalachicola River.	Port St. Joe, Fla.
Central of Georgia.	Georgia-Alabama State line (west of Hilton, Ga.).	Dothan, Ala.
Chesapeake & Ohio.	South line of Starke County, Ind. (north of Beardstown, Ind.).	Griffith, Ind.
Do.....	Michigan-Indiana State line (south of New Buffalo, Mich.).	Porter and La Crosse, Ind. <sup>1</sup>
Louisville & Nashville.	West line of Taylor County, Ky. (east of Whitewood, Ky.).	Greensburg, Ky.

See footnotes at end of table.

Railroad	From—	To—
Monon.....	North line of Pulaski County, Ind. (south of San Pierre, Ind.).	Michigan City, Ind. and Hammond, Ind.
Do.....	West line of White County, Ind. (west of Lee, Ind.).	Hammond, Ind. and Michigan City, Ind.
Penn Central.....	South line of Daviess County, Ind. (north of Petersburg, Ind.).	Ashby, Ind.
Seaboard Coast Line.	Georgia-Alabama State line (west of Esom, Ga.).	Birmingham, Ala.
Do.....	Georgia-Alabama State line (west of Omaha, Ga.).	Montgomery, Ala.
Do.....	Georgia-Alabama State line (near Pyne, Ga.).	Parkwood, Ala.
Do.....	Georgia-Alabama State line (west of Saffold, Ga.).	Abbeville, Elba, and Montgomery, Ala.
Tennessee, Alabama & Georgia.	Georgia-Alabama State line (southwest of Mcnlo, Ga.).	Gadsder, Ala.

<sup>1</sup> Effective only from 2 a.m. on the last Sunday in October to 2 a.m. on the last Sunday in April; exception unnecessary during the remainder of the year because during that period Michigan time is not advanced and therefore is the same as central standard time (advanced).

(3) *Indiana and Ohio operations included in Michigan nonadvanced time.* Those parts of the following lines of railroad located east of the zone boundary described in this section, are, for operating purposes only, excepted from the eastern standard time zone to permit operations in accordance with Michigan nonadvanced eastern standard time during the period from 2 a.m. on the last Sunday in April to 2 a.m. on the last Sunday in October:

Railroad	From—	To—
Chesapeake & Ohio.	Michigan-Ohio State line (north of Alexis, Ohio).	Alexis, Ohio.
Detroit & Toledo Shore Line.	Michigan-Ohio State line (north of Toledo, Ohio).	Toledo, Ohio.
Penn Central.....	Michigan-Indiana State line (north of Vistula, Ind.).	Tower B, Elkhart, Ind.
Do.....	Michigan-Ohio State line (north of Alexis, Ohio).	Alexis, Ohio.
Do.....	Michigan-Indiana State line (south of Niles, Mich.).	South Bend, Ind.
Do.....	Michigan-Indiana State line (south of Sturgis, Mich.).	Fort Wayne, Ind.

(4) *Michigan operations excepted from Michigan nonadvanced eastern*

*standard time.* Those parts of the following lines of railroad located within the State of Michigan and east of the zone boundary described in this section, are, for operating purposes only, excepted from the requirement to operate in accordance with Michigan's nonadvanced eastern standard time and are authorized to operate on eastern standard time (advanced) during the period from 2 a.m. on the last Sunday in April to 2 a.m. on the last Sunday in October.

Railroad	From—	To—
Ann Arbor.....	Ohio-Michigan State line (north of Alexis, Ohio).	Owosso, Mich.
Detroit, Toledo & Ironton.	Ohio-Michigan State line (north of Metamora, Ohio).	Detroit and Dearborn, Mich.
Do.....	Ohio-Michigan State line (north of Denson, Ohio).	Tecumseh, Mich.
Do.....	Ohio-Michigan State line (north of Alexis, Ohio) (over the tracks of the Ann Arbor Railroad).	Diann, Mich.
Penn Central.....	Indiana-Michigan State line (north of Ray, Ind.).	Jackson, Mich.
Do.....	White Pigeon Junction, Mich.	Jonesville, Mich.
Do.....	Litchfield, Mich.	Osseo, Mich.
Do.....	Bankers, Mich.	North Adams, Mich.
Do.....	Morenci, Mich.	Palmyra, Mich.
Do.....	Clayton, Mich.	Ida, Mich.
Do.....	Ohio-Michigan State line (south of Ottawa Lake, Mich.).	Clinton, Mich.
Do.....	Ohio-Michigan State line (north of Alvordton, Ohio).	Jackson, Mich.
Do.....	Cement City, Mich.	Brooklyn, Mich.

(h) *Municipalities on boundary line.* All municipalities located upon the zone boundary line described in this section are in the central standard time zone, except Apalachicola, Fla., which is in the eastern standard time zone.

§ 71.6 Central zone.

The third zone, the central standard time zone, includes that part of the United States that is west of the boundary line between the eastern and central standard time zones described in § 71.5 and east of the boundary line between the central and mountain standard time zones described in § 71.7.

§ 71.7 Boundary line between central and mountain zones.

(a) *Montana-North Dakota.* Beginning at the junction of the Montana-North Dakota boundary with the boundary of the United States and Canada southerly along the Montana-North Dakota boundary to the Missouri River; thence southerly and easterly along the middle of that river to the midpoint of the confluence of the Missouri and Yellowstone Rivers; thence southerly and easterly along the middle of the Yellowstone River to the north boundary of T. 150 N., R. 104 W.; thence east to the northwest corner of T. 150 N., R. 102 W.; thence south to the southwest corner of T. 149 N., R. 102 W.; thence east to the northwest corner of T. 148 N., R. 102 W.; thence south to the northwest corner of T. 147 N., R. 102 W.; thence east to the southwest corner of T. 148 N., R. 101 W.; thence south to the middle of the Little Missouri; thence easterly and northerly along the middle of that river to the midpoint of its confluence with the Missouri River; thence southerly and easterly along the middle of the Missouri River to the north line of Morton County; thence west along the north line of Morton County to the northwest corner of T. 140 N., R. 83 W.; thence south to the southwest corner of T. 140 N., R. 83 W.; thence east to the southeast corner of T. 140 N., R. 83 W.; thence south to the middle of the Heart River; thence easterly and northerly along the middle of that river to the southern boundary of T. 139 N., R. 82 W.; thence east to the middle of the Heart River; thence southerly and easterly along the middle of that river to the midpoint of the confluence of the Heart and Missouri Rivers; thence southerly and easterly along the middle of the Missouri River to the northern boundary of T. 130 N., R. 80 W.; thence west to the northwest corner of T. 130 N., R. 80 W.; thence south to the North Dakota-South Dakota boundary; thence easterly along that boundary to the middle of the Missouri River.

(b) *South Dakota.* From the junction of the North Dakota-South Dakota boundary with the Missouri River southerly along the main channel of that river to the crossing of the Chicago & North Western Railway near Pierre; thence southwesterly to the northeast corner of T. 1 S., R. 28 E. in Jones County; thence south along the range line between Rs.

28 and 29 E. to the north line of Mellette County; thence east along the north line of Mellette County to the west line of Tripp County; thence south along the west line of Tripp County to the North Dakota-Nebraska boundary.

(c) *Nebraska*. From the junction of the west line of Tripp County, South Dakota with the South Dakota-Nebraska boundary west along that boundary to the west line of R. 30 W.; thence south along the range line between Rs. 30 and 31 W. to the southwest corner of sec. 19, T. 33 N., R. 30 W.; thence easterly along section lines to the northeast corner of sec. 29, T. 33 N., R. 30 W.; thence southerly along section lines with their offsets to the northeast corner of sec. 17, T. 32 N., R. 30 W.; thence westerly along section lines to the northwest corner of sec. 18, T. 32 N., R. 30 W.; thence southerly along the range line to the southwest corner of T. 31 N., R. 30 W.; thence easterly along the township line to the northeast corner of T. 30 N., R. 30 W.; thence southerly along the range line to the southwest corner of T. 29 N., R. 29 W.; thence westerly along the township line to the northwest corner of sec. 4, T. 28 N., R. 30 W.; thence southerly along section lines to the southwest corner of sec. 33, T. 28 N., R. 30 W.; thence easterly along the township line to the northeast corner of sec. 4, T. 27 N., R. 30 W.; thence southerly along section lines to the southwest corner of sec. 22, T. 26 N., R. 30 W.; thence easterly along section lines to the southeast corner of sec. 24, T. 26 N., R. 30 W.; thence southerly along the range line to the north line of Thomas County; thence westerly along the north line of Thomas County to the west line of Thomas County; thence south along the west line of Thomas County to the north line of McPherson County; thence west along the north line of McPherson County to the west line of McPherson County; thence south along the west line of McPherson County to the north line of Keith County; thence east along the north line of Keith County to the west line of Lincoln County; thence south along the west line of Lincoln County to the north line of Hayes County; thence west along the north line of Hayes County to the west line of Hayes County; thence south along the west line of Hayes and Hitchcock Counties to the Nebraska-Kansas boundary.

(d) *Kansas-Colorado*. From the junction of the west line of Hitchcock County, Nebr., with the Nebraska-Kansas boundary westerly along that boundary to the northwest corner of the State of Kansas; thence southerly along the Kansas-Colorado boundary to the north line of Sherman County, Kans.; thence easterly along the north line of Sherman County to the east line of Sherman County; thence southerly along the east line of Sherman County to the north line of Logan County; thence westerly along the north line of Logan County to the east line of Wallace County; thence southerly along the east line of Wallace County to the north line of Wichita County; thence westerly along the north line of Wichita County to the east line of Greeley County; thence southerly along the east line of Greeley County to the north line of Hamilton County; thence easterly along the north line of Hamilton and Kearny Counties to the junction of the east line of R. 36 W.; thence southerly along the range line between Rs. 35 and 36 W. with its offset to the south line of Kearny County; thence westerly along the south line of Kearny and Hamilton Counties to the Kansas-Colorado boundary; thence southerly along the Kansas-Colorado boundary to the junction of that boundary with the north boundary of the State of Oklahoma.

(e) *Oklahoma-Texas-New Mexico*. From the junction of the Kansas-Colorado boundary with the northern boundary of the State of Oklahoma westerly along the Colorado-Oklahoma boundary to the northwest corner of the State of Oklahoma; thence southerly along the west boundary of the State of Oklahoma and the west boundary of the State of Texas to the southeast corner of the State of New Mexico; thence westerly along the Texas-New Mexico boundary to the east line of Hudspeth County, Tex.; thence southerly along the east line of Hudspeth County, Tex., to the boundary between the United States and Mexico.

(f) *Operating exceptions*—(1) *Lines east of boundary excepted from central zone*. Those parts of the following lines of railroad, located east of the zone boundary line described in this section, are, for operating purposes only, excepted from the central standard time zone and are included within the mountain standard time zone:



Railroad	From—	To—
Atchison, Topeka, & Santa Fe.	East line of T. 24 S., R. 36 W., Kearny County, Kans.	Scott City and Dodge City, Kans.
Do.....	Kansas-Colorado State line.	Satanta, Kans.
Do.....	Colorado-Oklahoma State line.	Dodge City, Kans., via Boise City, Okla.
Chicago, Burlington, & Quincy.	East line of Hooker County, Nebr.	Ravenna, Nebr.
Do.....	East line of Perkins County, Nebr.	Holdrege, Nebr.
Do.....	East line of Chase County, Nebr.	McCook, Nebr.
Do.....	East line of Dundy County, Nebr.	Do.
Chicago, Milwaukee, St. Paul & Pacific.	Missouri River, S. Dak.	Mobridge, S. Dak.
Chicago & Northwestern.	West line of T. 34 N., R. 30 W., Cherry County, Nebr.	Long Pine, Nebr.
Great Northern..	Montana-North Dakota State line.	Williston, N. Dak.
Do.....	Yellowstone River, N. Dak.	Waterford City, N. Dak.
Northern Pacific.	East line of T. 138 N., R. 83 W., Morton County, N. Dak.	Mandan, N. Dak.
Do.....	North line of T. 140 N., R. 81 W., Morton County, N. Dak.	Do.
Do.....	South line of T. 139 N., R. 81 W., Morton County, N. Dak.	Do.
Union Pacific....	East line of Keith County, Nebr.	North Platte, Nebr.
Do.....	East line of Wallace County, Kans.	Ellis, Kans.

(2) *Lines west of boundary included in central zone.* Those parts of the following lines of railroad located west of the zone boundary line described in this section are, for operating purposes only, excepted from the mountain standard time zone and are included within the central standard time zone:

Railroad	From—	To—
Atchison, Topeka, & Santa Fe.	Texas-New Mexico State line (near Texico, N. Mex.).	Clovis, N. Mex.
Chicago, Rock Island & Pacific.	Texas-New Mexico State line.	Tucumcari, N. Mex.
Do.....	West line of Thomas County, Kans.	Goodland, Kans.

Railroad	From—	To—
Missouri.....	West line of Wichita County, Kans.	Pueblo, Colo.
Soo Line.....	Montana-North Dakota State line.	Whitetail, Mont.
Southern Pacific.	East line of Hudspeth County, Tex.	El Paso, Tex.
Texas & Pacific.	.....do.....	Do.
Texas-New Mexico.	Texas-New Mexico State line.	Lovington, N. Mex.

(g) *Points on boundary line.* All municipalities located upon the zone boundary line described in this section are in the mountain standard time zone, except Murdo, S. Dak., which is in the central standard time zone.

§ 71.8 Mountain zone.

The fourth zone, the mountain standard time zone, includes that part of the United States that is west of the boundary line between the central and mountain standard time zones described in § 71.7 and east of the boundary line between the mountain and Pacific standard time zones described in § 71.9.

§ 71.9 Boundary line between mountain and Pacific zones.

(a) *Montana-Idaho-Oregon.* From the junction of the Idaho-Montana boundary with the boundary between the United States and Canada southerly along the Idaho-Montana boundary to the boundary line between Idaho County, Idaho, and Lemhi County, Idaho; thence southwesterly along the boundary line between those two counties to the main channel of the Salmon River; thence westerly along the main channel of the Salmon River to the Idaho-Oregon boundary; thence southerly along that boundary to the boundary line between Baker County, Oreg., and Malheur County, Oreg.; thence westerly along the north line of Malheur County to the northwest corner of Malheur County; thence southerly along the west line of Malheur County to the southwest corner of T. 35 S., R. 37 E.; thence east to the Idaho-Oregon boundary; thence south along that boundary to the southwest corner of the State of Idaho; thence easterly along the Idaho-Nevada boundary to the northeast corner of the State of Nevada.

(b) *Utah-Nevada-Arizona-California.* From the northeast corner of the State

of Nevada southerly along the Utah-Nevada boundary, the Nevada-Arizona boundary, and the Arizona-California boundary to the boundary between the United States and Mexico.

(c) *Operating exceptions*—(1) *Lines east of boundary excepted from mountain zone.* Those parts of the following lines of railroad located east of the zone boundary line described in this section, are, for operating purposes only, excepted from the mountain standard time zone and are included within the Pacific standard time zone:

Railroad	From—	To—
Great Northern..	Troy, Mont.....	Montana-Idaho State line.
Northern Pacific..	Paradise, Mont.....	Do.
Southern Pacific..	Ogden, Utah.....	Utah-Nevada State line.
Western Pacific...	Salt Lake City, Utah.	Do.
Do.....	Burmester, Utah..	Warner, Utah.

(2) *Lines west of boundary included in mountain zone.* Those parts of the following lines of railroad located west of the zone boundary line described in this section, are, for operating purposes only, excepted from the Pacific standard time zone and are included in the mountain standard time zone:

Railroad	From—	To—
Atchison, Topeka, & Santa Fe.	Colorado River...	Southern limits of Needles, Calif.
Chicago, Milwaukee, St. Paul & Pacific.	Montana-Idaho State line.	Avery, Idaho.
Union Pacific....	Idaho-Nevada State line near Idavada, Idaho.	Wells, Nevada.
Do.....	West line of Malheur County, Oreg.	Burns, Oreg.

(d) *Points on boundary line.* All municipalities located upon the zone boundary line described in this section are in the mountain standard time zone.

§ 71.10 Pacific zone.

The fifth zone, the Pacific standard time zone, includes that part of the United States that is west of the boundary line between the mountain and Pacific standard time zones described in § 71.9 and east of 137° W. longitude.

§ 71.11 Yukon zone.

The sixth zone, the Yukon standard time zone, includes that part of the United States that is between 137° W. longitude and 141° W. longitude.

§ 71.12 Alaska-Hawaii zone.

The seventh zone, the Alaska-Hawaii standard time zone, includes that part of the United States that is between 141° W. longitude and 162° W. longitude and including all of the State of Hawaii.

§ 71.13 Bering zone.

The eighth zone, the Bering standard time zone, includes that part of the United States that is between 162° W. longitude and 172°30' W. longitude and that part of the Aleutian Islands that is west of 172°30' W. longitude, but does not include any part of the State of Hawaii.

# ANNEX 11.G.4.

**Title 49—Transportation**  
**Subtitle A—Office of the Secretary of**  
**Transportation**

[Docket No. 21; Amdt. 71-13]

**PART 71—STANDARD TIME ZONE**  
**BOUNDARIES\***

**Relocation of Eastern-Central Standard**  
**Time Zone Boundary in the State of**  
**Michigan**

The purpose of this amendment to part 71 of title 49 of the Code of Federal Regulations is to change the existing boundary line between the eastern time zone and the central time zone as it relates to the State of Michigan.

On March 15, 1973, the Department of Transportation published in the *FEDERAL REGISTER* (38 FR 7009), a notice of proposed rulemaking to relocate a segment of the boundary between the eastern and central time zones from its present location along the border between the State of Wisconsin and the Upper Peninsula of the State of Michigan northward in order to include four Upper Peninsula counties along the Wisconsin border (Menominee, Dickinson, Iron, and Gogebic) in the central time zone.

The proposal was based on a petition from the Board of County Commissioners of each of the four counties. The petitions cited two reasons for seeking the change—closer commercial relations with neighboring communities in the State of Wisconsin, which is in the central zone, than with the rest of the State of Michigan; and the recent decision of the State of Michigan to observe advanced (daylight, or "fast") time beginning in 1973. From 1969 to 1972, the State of Michigan exercised its option under section 3(a) of the Uniform Time Act of 1966 (15 U.S.C. § 260a) and exempted itself from the observance of advanced time. Thus, eastern standard (slow) time was observed throughout the year in Michigan. All or part of the four counties concerned are further west than Chicago, Ill., which is in the central zone; the westernmost of the counties, Gogebic, is as far west as St. Louis, Mo., which is also in the central zone. (In fact, the westernmost part of Gogebic County is farther west than the 19th meridian west of Greenwich, which is the standard meridian of the central zone.) Under eastern advanced time, during the summer, areas that far west have daylight on some days as late as 10:30 p.m.; under central advanced time (which is the same time on the clock as eastern standard time) there is daylight on those days only as late as 9:30 p.m.

Under the Uniform Time Act of 1966, the Secretary of Transportation is authorized to modify the boundaries of time zones "having regard for the convenience of commerce and the existing junction points and division points of common carriers engaged in interstate or foreign commerce."

Interested persons were given a 22-day period within which to comment in writing on the proposed change. In addition, a representative of the Department conducted a public hearing on the proposal in each of the four counties, during which interested persons had opportunity to comment on the proposal either orally or in writing, or both. Although percentages varied county by county, comments received from each county overwhelmingly favor the proposal. Of the total of approximately 1,500 persons who submitted comments, approximately 90 percent favor the proposal, and document commercial relations with both the State of Wisconsin and other areas in the central time zone close enough to demonstrate that the convenience of commerce would be served by including the four counties in the central time zone. Among those favoring the proposal is North Central Airlines, Inc., the only certificated air carrier engaged in interstate commerce in the four-county area.

The Department also invited comments on whether any counties in the Upper Peninsula contiguous to the four named should be placed in the central zone. Since very few persons addressed themselves to this, only the four counties named are being placed in the central zone at this time. Many persons, however, urged the Department to locate the boundary line farther east in the Upper Peninsula, between the counties of Alger and Schoolcraft in the west and the counties of Luce and Mackinac in the east. These counties meet in a straight north-south line approximately 86° west of Greenwich. These persons contend that—

- (1) There are two discernible economic areas in the Upper Peninsula;
- (2) The 12 Upper Peninsula counties west of this north-south line (Alger, Baraga, Delta, Dickinson, Gogebic, Houghton, Iron, Keweenaw, Marquette, Menominee, Ontonagon, and Schoolcraft) form an area closely tied economically to the State of Wisconsin;
- (3) The three Upper Peninsula counties east of this line (Chippewa, Luce, and Mackinac) form another, closely tied economically to the Lower Peninsula of Michigan;
- (4) This north-south line runs through a sparsely populated section of the Upper Peninsula and relocating the time zone boundary along it would inconvenience relatively few people.

Although the Department recognizes the validity of these contentions, relocation of the boundary that far east was not within the scope of the proposal which led to this rulemaking. These contentions will, however, be considered as the Department evaluates the effect of the relocation which is being made.

Advanced time begins this year at 2 a.m., Sunday, April 29. Making the relocation of the boundary effective at that time will serve both the convenience of

\*Federal Register, Title 49 (Transportation), "Part 71—Standard Time Zone Boundaries," 38, No. 70, pp. 9228-9229 (April 12, 1973).

Title 49—Transportation

commerce and the convenience of the persons living in the area affected by the change (since eastern standard time is the same time on the clock as central advanced time, they will not have to change their clocks). I therefore find that good cause exists for making this amendment effective in fewer than 30 days after publication in the FEDERAL REGISTER.

In consideration of the foregoing, effect at 2 a.m. on April 29, 1973, paragraph (a) of § 71.5 of title 49 of the Code of Federal Regulations is amended to read as follows:

**§ 71.5 Boundary line between eastern and central zones.**

(a) *Minnesota-Michigan-Wisconsin.*— From the junction of the western boundary of the State of Michigan with the boundary between the United States and Canada northerly and easterly along the west line of Gogebic County to the west line of Ontonagon County; thence south along the west line of Ontonagon County to the north line of Gogebic County; thence southerly and easterly along the north line of Gogebic County to the west line of Iron County; thence north along the west line of Iron County to the north line of Iron County; thence east along the north line of Iron County to the east line of Iron County; thence south along the east line of Iron County to the north line of Dickinson County; thence east along the north line of Dickinson County to the east line of Dickinson County; thence south along the east line of Dickinson County to the north line of Menominee County; thence east along the north line of Menominee County to the east line of Menominee County; thence southerly and easterly along the east line of Menominee County to Lake Michigan; thence east to the western boundary of the State of Michigan; thence southerly and easterly along the western boundary of the State of Michigan to a point in the middle of Lake Michigan opposite the main channel of Green Bay; thence southerly along the western boundary of the State of Michigan to its junction with the southern boundary thereof and the northern boundary of the State of Indiana.

This amendment does not concern adherence to or exemption from advanced time. The Uniform Time Act of 1966 requires observance of advanced time from 2 a.m. on the last Sunday in April to 2 a.m. on the last Sunday in October of each year, but permits any State to exempt itself from this requirement by law applicable to the entire State. A State that has parts in more than one time zone may exempt the entire area within one time zone without exempting the entire State. Thus, that part of the State of Michigan which is hereby placed in the central time zone must, under existing law in the State of Michigan, observe central advanced time from 2 a.m. on the last Sunday in April to 2 a.m. on the last Sunday in October of each year. That entire part may, however, be exempted from such observance by act of the Michigan legislature. The Department of

Transportation does not have any administrative authority with respect to this requirement.

(Act of March 19, 1918, as amended by the Uniform Time Act of 1966, 15 U.S.C. 260-267; sec. 6(e)(5), Department of Transportation Act, 49 U.S.C. 1655(e)(5).)

Issued in Washington, D.C., on April 10, 1973.

CLAUDE S. BRINEGAR,  
*Secretary of Transportation.*

[FR Doc.73-7199 Filed 4-11-73;8:45 am]

# ANNEX 11.G.5.

## Title 49—Transportation

### SUBTITLE A—OFFICE OF THE SECRETARY OF TRANSPORTATION

[OST Docket No. 34]

#### PART 73—EMERGENCY DAYLIGHT SAVING TIME

##### Procedures and Criteria for Implementation

The Emergency Daylight Saving Time Energy Conservation Act of 1973 (December 15, 1973, Pub. L. 93-182) ("the Act") advances the standard time by one hour in all eight standard time zones of the United States continuously from 2:00 a.m. Sunday, January 6, 1974, to 2:00 a.m. Sunday, April 27, 1975, and provides that the time as so advanced shall be standard time. The purpose of the regulations which appear below is to set forth procedures and criteria for implementation of the Act.

Two classes of States are permitted to exempt themselves from advanced time: (1) Any State which is entirely within one time zone and not contiguous to any other State (Hawaii, Puerto Rico, and the Virgin Islands); and (2) any State with parts thereof in more than one time zone (Alaska, Florida, Idaho, Indiana, Kansas, Kentucky, Michigan, Nebraska, North Dakota, Oregon, South Dakota, Tennessee, and Texas). (Section 3(a)). If a State elects to exempt itself, the exemption must apply to the entire area of the State lying within one time zone, and the effect of the exemption must be to put the entire State on uniform time (i.e. the exemption can only apply to that part of the State in the more easterly zone) (see H. Rep. No. 93-709 at 5). While this limitation could not be literally applied to Alaska, which is in four time zones, any exemption for that State would have to take account of this intent of Congress.

Section 3(c) of the Act provides that any law in effect on October 27, 1973, exempting a State from advanced time under section 3(a) of the Uniform Time Act of 1966 (15 U.S.C. § 260a(a)) shall remain in effect as the exercise by the State of the exemption permitted by section 3(a) of the Act unless the State by law provides that such exemption shall not apply during the effective period of the Act. Thus, the effect of section 3(c) of the Act is to continue exemptions enacted by Indiana, Hawaii, Puerto Rico and the Virgin Islands, unless the legislature passes a law providing that the exemption shall not apply. (The State of Arizona has also enacted an exemption pursuant to section 3(a) of the Uniform Time Act which was in effect October 27, 1973; however, that exemption does not remain in effect and Arizona may not otherwise exempt itself because, although it lies entirely within one time zone, it is contiguous to another State and therefore does not satisfy the statutory requirements for exemption.)

States permitted exemptions by section 3(a) may exempt themselves from advanced time anytime during the period

---

\*Federal Register, Title 49 (Transportation) "Part 73—Emergency Daylight Saving Time", 38, No. 244, pp. 34876-34878 (December 20, 1973)—Added in proof.

## Title 49—Transportation

the Act is in effect. The exemption must, however, be complete; a State may not elect to exempt itself from advanced time during winter months but observe advanced time during summer months.

Section 3(b) of the Act permits the President to grant a State an exemption from the advanced time established by section 3(a) of the Act or a request for realignment of the existing limits of time zones, if the State, by proclamation of its Governor, makes a finding prior to Sunday, January 6, 1974—the effective date of the Act—that such exemption or realignment is necessary to avoid undue hardship or to conserve fuel in such State or part thereof. (“[The President’s] decision should be based on the appropriateness of all aspects of any exemption, including convenience of commerce, possible energy savings, or undue hardship to large segments of the population, as well as the possible impact on the success of and cooperation with the national energy conservation program.” S. Rept. No. 93-504 at 3.)

By Executive Order 11751, issued December 15, 1973, the President has designated and empowered the Secretary of Transportation to exercise the authority vested in him by section 3(b) to grant the exemptions or realignments.

The last regular Federal workday before the effective date of the Act is Friday, January 4, 1974. Therefore, proclamations should be received by the Department of Transportation not later than 5:30 p.m. eastern standard time on that date.

Section 2 of the Executive Order establishes the following criteria to guide the Secretary in the exercise of the authority delegated by the Order:

1. The policy of the United States, as expressed in section 2 of the Uniform Time Act of 1966 (15 U.S.C. 260), to promote the adoption and observance of uniform time within the standard time zones of the United States. This means that an exemption will not ordinarily be granted to an area if the effect would be to put it on a time different from all contiguous areas.

2. *The convenience of commerce.* This is the primary standard in section 4 of the Uniform Time Act of 1966 (15 U.S.C. 261) guiding the Secretary’s decisions whether to modify time zone limits under that section. This means that the problems of carriers engaged in interstate and foreign commerce and of the broadcast media will be given considerable weight in determining whether an exemption or realignment will be granted.

3. *Possible energy savings.* The rationale behind the Act is that year-round advanced time will conserve energy. Since any exemption or realignment may interfere with the testing of this rationale, a Governor claiming that an exemption or realignment will conserve fuel must produce evidence substantiating the effect on fuel use in the subject area and in related power-consumption areas.

4. *Undue hardship to large segments of the population.* Included within this criterion are considerations of the com-

merce and industry in the area covered by the proclamation, weather conditions, problems of school children that cannot be dealt with adequately by State and local authorities, motor vehicle traffic patterns and densities, commercial and energy relationships with surrounding areas, and location on the western edges of a time zone which has a severe westward extension. For a showing of “undue” hardship, the effects must substantially exceed those consequences presumably recognized by the Congress as necessarily incident to advanced time during winter months.

5. *Possible impact on the success of and cooperation with the national energy conservation program.* Many of the measures being taken or planned as part of the national energy conservation program are directed, among other things, to the reduction and shift of peak energy demands, increased use of mass transportation and car pools, increased load factors in commercial aviation, and conversion of heating and power plants to alternative fuels. Any exemption or realignment inconsistent with, or counterproductive to the success of, any of these measures will be denied unless specific evidence is presented that an overriding reason exists for granting the exemption or realignment.

In deciding whether to grant an exemption or realignment the Secretary may, by virtue of section 3 of the Executive Order, seek information and advice from any appropriate Federal agency.

Any exemption enacted pursuant to section 3(a) and any exemption or realignment granted pursuant to section 3(b) expires contemporaneously with the expiration of the Act at 2:00 a.m. Sunday, April 27, 1975, at which time only those exemptions enacted pursuant to section 3(a) of the Uniform Time Act of 1966, as amended, and time zone limits as they existed on October 27, 1973, will be effective.

In addition to the foregoing, the Act contains other significant provisions:

1. Section 5 suspends for the duration of the Act the authority of the Secretary under section 4 of the Uniform Time Act of 1966 (15 U.S.C. 261) to modify the limits of time zones. During the effective period of the Act, time zone limits may be realigned only in accordance with section 3(b) of the Act and only for the duration of the Act.

2. Section 3(d) makes applicable to the Act the preemption provision in section 3(b) of the Uniform Time Act of 1966 (15 U.S.C. 260a(b)), superseding all laws of States and their political subdivisions insofar as they are inconsistent with the six months of advanced time established by section 3(a) of the Uniform Time Act. Thus, during the effective period of the Act, all laws of States and their political subdivisions are superseded to the extent they are inconsistent with the Act.

3. The authority of the Secretary under section 3(c) of the Uniform Time Act of 1966 (15 U.S.C. 260a(c)) to seek enforcement in the appropriate United States District Courts of the advanced

time provision of the Uniform Time Act of 1966, as amended, is made applicable to the Act by section 3(d) of the Act.

4. The Secretary, with the cooperation of all appropriate Federal agencies, is required to study the full range of effects of the year-round advanced time established by the Act and to submit two reports to Congress thereon. In order to limit the number of variables affecting the operation of the Act and improve the reliability of the study, an exemption or realignment granted by the Secretary may not be revoked or modified during the effective period of the Act except with the prior written approval of the Secretary.

Because of the emergency nature of the Act and the short period of time between its enactment December 15, 1973, and its taking effect January 6, 1974, I find that notice and public procedure on these regulations is contrary to the public interest and that good cause exists for making them effective in fewer than 30 days after publication in the FEDERAL REGISTER.

In consideration of the foregoing, Title 49 of the Code of Federal Regulations is amended by adding thereto a new Part 73, to read as follows:

### Subpart A—General

- Sec.
- 73.1 Purpose.
- 73.3 Definitions.
- 73.5 State exemption for State in two time zones.
- 73.7 Grant of exemption or realignment by the Secretary.
- 73.9 Reduction in number of time zones.
- 73.11 Restrictions on exemptions and realignments.
- 73.13 Expiration of exemptions and realignments.

### Subpart B—Procedures and Criteria

- 73.21 Submission of proclamation of a Governor.
  - 73.23 Decision of the Secretary.
  - 73.25 Criteria.
- AUTHORITY: Pub. L. 93-182, December 15, 1973; Executive Order 11751, December 15, 1973; 5 U.S.C. 552(a) (1).

### Subpart A—General

- § 73.1 Purpose.
- This part sets forth the procedures and criteria for implementation of the Emergency Daylight Saving Time Energy Conservation Act of 1973 (December 15, 1973, Pub. L. 93-182) (“the Act”).
- § 73.3 Definitions.
- As used in this part—  
“Governor of a State” and “Governor” include the Commissioner of the District of Columbia, the Commissioner of the Commonwealth of Puerto Rico, and the Governor of the Virgin Islands.  
“Secretary” means the Secretary of Transportation.  
“State” includes the District of Columbia, the Commonwealth of Puerto Rico, and any possession of the United States.
- § 73.5 State exemption for State in two time zones.
- An exemption enacted pursuant to section 3(a) of the Act by a State with parts thereof in two time zones may apply only

## Title 49—Transportation

to all that part of the State which is in the more easterly time zone.

### § 73.7 Grant of exemption or realignment by the Secretary.

(a) A request for exemption or realignment pursuant to section 3(b) of the Act may be granted in whole or in part.

(b) An exemption will not ordinarily be granted pursuant to section 3(b) of the Act to an area if the effect would be to put that area on a time different from the time observed in all contiguous areas.

### § 73.9 Reduction in number of time zones.

No realignment of time zone limits will be granted pursuant to section 3(b) of the Act if the effect of such realignment would be to reduce the number of time zones in the United States.

### § 73.11 Restrictions on exemptions and realignments.

(a) An area exempted from the observance of advanced time or affected by a realignment pursuant to section 3(b) of the Act shall observe continuously from 2:00 a.m. Sunday, January 6, 1974, to 2:00 a.m. Sunday, April 27, 1975, the standard time applicable January 5, 1974, to the standard time zone in which the area is located. Exemptions or realignments may be revoked or modified only with the approval of the Secretary.

(b) A State may not exercise the exemption authority contained in section 3(a) of the Act in a manner which would frustrate the intent of the Act that either advanced time or non-advanced time will be observed on a year-round basis by each State.

### § 73.13 Expiration of exemptions and realignments.

Exemptions enacted pursuant to section 3(a) of the Act, and exemptions from advanced time or realignments of time zone limits granted pursuant to section 3(b) of the Act, expire contemporaneously with the expiration of the Act at 2:00 a.m. Sunday, April 27, 1975. At that time, only those exemptions enacted pursuant to section 3(a) of the Uniform Time Act of 1966, as amended, and alignments of time zone limits as they existed October 27, 1973, will be effective.

### Subpart B—Procedures and Criteria

#### § 73.21 Submission of proclamation of a Governor.

(a) A certified copy of a proclamation issued by the Governor of a State pursuant to section 3(b) of the Act must be forwarded to the Docket Clerk, Office of the General Counsel, TGC, Department of Transportation, 400 Seventh Street SW., Washington, D.C. 20590, and should be mailed in time to be received by 5:30 p.m. eastern standard time Friday, January 4, 1974.

(b) For proclamations transmitted by telecopier, the telephone number is Area Code 202, 426-4193. A certified copy of a proclamation transmitted in this manner shall be forwarded to the Docket Clerk in accordance with paragraph (a) of this section immediately upon completion of transmission.

(c) A proclamation must include, or be accompanied by, a statement of the claims of undue hardship or fuel conservation on which the proclamation is based, and supporting facts. Additional information may be requested by the Secretary and the proclamation should

be accompanied by the name, title, address, and telephone number of the official of the State to be contacted by the Secretary for that purpose.

#### § 73.23 Decision of the Secretary.

Proclamations received in accordance with § 73.21 of this part will be acted upon as expeditiously as practicable. The decision of the Secretary will be communicated to the Governor by telegram and confirmed by letter.

#### § 73.25 Criteria.

Consistent with the legislative history of section 3(b) of the Act, the Secretary's decision will be based on consideration of the appropriateness of all aspects of the exemption or realignment. This will involve, necessarily, a consideration and balancing of the objectives sought to be achieved by the Act, including:

(1) The policy of the United States, as expressed in section 2 of the Uniform Time Act of 1966 (15 U.S.C. 260), to promote the adoption and observance of uniform time within the standard time zones of the United States.

(2) The convenience of commerce.

(3) Possible energy savings.

(4) Undue hardship to large segments of the population.

(5) Possible impact on the success of and cooperation with the national energy conservation program.

*Effective date:* This Part is effective December 20, 1973.

Issued in Washington, D.C., on December 19, 1973.

CLAUDE S. BRINEGAR,  
Secretary of Transportation.

[FR Doc.73-27018 Filed 12-19-73;12:49 pm]

## ANNEX 11.G.5.a.

Office of the Secretary  
[OST Docket No. 34, Notice No. 74-3]

### ARIZONA Emergency Daylight Saving Time Exemption

The Emergency Daylight Saving Time Energy Conservation Act of 1973 (December 15, 1973, Pub. Law 93-182) ("the Act") advances the standard time by one hour in all eight standard time zones of the United States continuously from 2 a.m. Sunday, January 6, 1974, to 2 a.m. Sunday, April 27, 1975, and provides that the time as so advanced shall be standard time.

Section 3(b) of the Act permits the President to grant a State an exemption from advanced time established by section 3(a) of the Act or a request for realignment of the existing limits of time zones, if the State, by proclamation of its Governor, makes a finding prior to Sunday, January 6, 1974—the effective date of the Act—that such exemption or realignment is necessary to avoid undue hardship or to conserve fuel in such State or part thereof. ("[The President's] decision should be based on the appropriateness of all aspects of any exemption, including convenience of commerce, possible energy savings, or undue hardship to large segments of the population, as well as the possible impact on the success of and cooperation with the national energy conservation program." S. Rept. No. 93-504 at 3.)

By Executive Order 11751, issued December 15, 1973, the President has designated and empowered the Secretary of Transportation to exercise the authority vested in him by section 3(b) to grant exemptions or realignments. Procedures and criteria for implementation were issued by the Secretary (49 CFR Part 73, 38 FR 34876).

The Governor of the State of Arizona, the Honorable John R. (Jack) Williams, by proclamation issued December 19, 1973, requests that the State of Arizona be exempted from observance of advanced time during the effective period of the Act.

The proclamation and supporting data submitted establish that Arizona had legislatively exempted itself from observance of advanced time under the Uniform Time Act of 1966; that the summer mean temperatures in the more populous areas of the State are such as to cause severe discomfort, and that observance of advanced time would severely increase this discomfort; that if Arizona were to observe year-round advanced time, greater power consumption would likely occur during summer months, without corresponding savings during winter months; and that much of the State's agricultural commerce with Mexico would be disrupted by observing advanced time.

Several residents of Arizona have submitted views in opposition to the Governor's proclamation. They did not, however, present specific data responsive to the criteria set forth in either the Act

or the regulations promulgated thereunder.

Upon consideration of the proclamation and supporting data, and all comments received, I find the requested exemption is consistent with the objectives sought to be achieved by the Act, and should be granted. I further find that the State of Arizona shall observe mountain nonadvanced (standard) time as standard time during the effective period of the Emergency Daylight Saving Time Energy Conservation Act of 1973.

Because of the emergency nature of the Act; the Congressional intent that it be implemented quickly<sup>1</sup>; the short period of time between its enactment December 15, 1973, and its taking effect January 6, 1974; and the short period of time between the date of the proclamation—December 19, 1973—and January 6, 1974, I find that notice and public procedure on this action are contrary to the public interest and that good cause exists for making it effective in fewer than 30 days after publication in the FEDERAL REGISTER. For these same reasons it has not been possible to assess the need for, and, if necessary, to prepare an environmental impact statement on this action. See section 102, National Environmental Policy Act of 1969 (January 1, 1970, Public Law 91-190, sec. 102, 83 Stat. 853; 42 U.S.C. 4332).

This action is taken pursuant to section 3(b) of the Emergency Daylight Saving Time Energy Conservation Act of 1973 (December 15, 1973, Public Law 93-182, § 3(b), 87 Stat. 708); Executive Order 11751 (38 FR 34725); and Part 73 of the Regulations of the Office of the Secretary of Transportation (49 CFR Part 73).

**Effective date.** This action is effective 2 a.m. mountain nonadvanced (standard) time Sunday January 6, 1974.

Issued in Washington, D.C., on January 4, 1974.

CLAUDE S. BRINEGAR,  
Secretary of Transportation.  
[FR Doc.74-765 Filed 1-9-74; 8:45 am]

[OST Docket No. 34, Notice No. 74-1]

### KENTUCKY Emergency Daylight Saving Time; Realignment

The Emergency Daylight Saving Time Energy Conservation Act of 1973 (December 15, 1973, Pub. Law 93-182) ("the Act") advances the standard time by one hour in all eight standard time zones of the United States continuously from 2 a.m. Sunday, January 6, 1974, to 2 a.m. Sunday, April 27, 1975, and provides that the time as so advanced shall be standard time.

Two classes of States are permitted to exempt themselves from advanced time: (1) Any State which is entirely within one time zone and not contiguous to any

<sup>1</sup> "[The Secretary] should act quickly and expeditiously. Failure to do so will risk serious inconvenience and uncertainty." See Senate Report No. 93-504 at 3.

other State (Hawaii, Puerto Rico, and the Virgin Islands); and (2) Any State with parts thereof in more than one time zone (Alaska, Florida, Idaho, Indiana, Kansas, Kentucky, Michigan, Nebraska, North Dakota, Oregon, South Dakota, Tennessee, and Texas). (Section 3(a)). If a State elects to exempt itself, the exemption must apply to the entire area of the State lying within one time zone, and the effect of the exemption must be to put the entire State on uniform time (i.e., the exemption can only apply to that part of the State in the more easterly zone) (see H. Rept. No. 93-709 at 5).

States permitted exemptions by section 3(a) may exempt themselves from advanced time anytime during the period the Act is in effect. The exemption must, however, be complete; a State may not elect to exempt itself from advanced time during winter months but observe advanced time during summer months.

Section 3(b) of the Act permits the President to grant a State an exemption from the advanced time established by section 3(a) of the Act or a request for realignment of the existing limits of time zones, if the State, by proclamation of its Governor, makes a finding prior to Sunday, January 6, 1974—the effective date of the Act—that such exemption or realignment is necessary to avoid undue hardship or to conserve fuel in such State or part thereof. ("[The President's] decision should be based on the appropriateness of all aspects of any exemption, including convenience of commerce, possible energy savings, or undue hardship to large segments of the population, as well as the possible impact on the success of and cooperation with the national energy conservation program." S. Rept. No. 93-504 at 3.)

By Executive Order 11751, issued December 15, 1973, the President has designated and empowered the Secretary of Transportation to exercise the authority vested in him by section 3(b) to grant the exemptions or realignments.

Procedures and criteria for implementation were promulgated by the Secretary (49 CFR Part 73, 38 FR 34876).

The Governor of the Commonwealth of Kentucky, the Honorable Wendell H. Ford, by proclamation issued January 3, 1974, requests the limits of the division between the eastern and central time zones in Kentucky be realigned during the effective period of the Act, to include within the central time zone all of the Commonwealth except twelve north-eastern counties (Boone, Kenton, Campbell, Grant, Pendleton, Bracken, Mason, Lewis, Greenup, Carter, Boyd, and Lawrence). The twelve counties which would remain in the eastern time zone are proximate to the Ohio and West Virginia State lines.

The proclamation and supporting data submitted by the Governor of Kentucky establish that more than 75 percent of the population of Kentucky live in the extreme western edge of the eastern time zone (as presently delineated); that observance of eastern advanced time within most of that portion of Kentucky in the eastern time zone would cause

\*Federal Register (Transportation)—"Emergency Daylight Saving Time"—DOT Exemption and Realignment to Certain States—39, No. 7, pp. 1524-1526 (January 10, 1974.)—Added in proof.



extreme hardship to school children, agriculture, and industry requiring daylight working conditions; that the convenience of commerce would be served by western Kentucky counties observing the same time as adjacent areas in Tennessee and Indiana; and that the proposed realignment would not be detrimental to the national energy conservation program. The data submitted also establish that the twelve counties which would remain in the eastern time zone are commercially related to adjacent areas in Ohio and West Virginia, and that the convenience of commerce would best be served by their continued observance of the same time as those areas.

Although section 3(a) of the Act contemplates State legislative action to achieve an exemption from observance of advanced time within one time zone of a State with parts in more than one zone, the proposed realignment may be obtained only under section 3(b).

Upon consideration of the proclamation and supporting data, I find the requested realignment of the limits of the eastern and central time zones within Kentucky is consistent with the objectives sought to be achieved by the Act. During the effective period of the Act, therefore, the limit between the eastern and central time zones in the Commonwealth of Kentucky shall be defined as follows:

From the junction of the east line of Spencer County, Indiana, with the Indiana-Kentucky boundary northerly and easterly along that boundary to the west line of Boone County, Kentucky; thence southerly along the west line of Boone County to the north line of Grant County; thence west along the north line of Grant County to the west line of Grant County; thence southerly along the west line of Grant County to the south line of Grant County; thence easterly along the south lines of Grant and Pendleton Counties to the west line of Bracken County; thence south along the west line of Bracken County to the south line of Bracken County; thence easterly along the south lines of Bracken, Mason, Lewis, and Carter Counties to the west line of Lawrence County; thence south along the west line of Lawrence County to the south line of Lawrence County; thence easterly and northerly along the south line of Lawrence County to its junction with the Kentucky-West Virginia boundary; thence southerly along the Kentucky-West Virginia boundary to the Kentucky-Tennessee boundary; thence west along the Kentucky-Tennessee boundary to its junction with the west line of Scott County, Tennessee.

Because of the emergency nature of the Act; the Congressional intent that it be implemented quickly; the short period of time between its enactment December 15, 1973, and its taking effect January 6, 1974; and the short period of time between the date of the proclamation—January 3, 1974—and January 6, 1974, I find that notice and public procedure on this action are contrary to the public interest and that good cause

<sup>1</sup> “[The Secretary] should act quickly and expeditiously. Failure to do will risk serious inconvenience and uncertainty.” See Senate Report No. 93-504 at 3.

exists for making it effective in fewer than 30 days after publication in the FEDERAL REGISTER. For these same reasons it has not been possible to assess the need for, and, if necessary, to prepare an environmental impact statement on this action. See section 102, National Environmental Policy Act of 1969 (January 1, 1970, Public Law 91-190, section 102, 83 Stat. 853; 42 U.S.C. 4332).

This action is taken pursuant to section 3(b) of the Emergency Daylight Saving Time Energy Conservation Act of 1973 (December 15, 1973, Pub. Law 93-182, section 3(b), 87 Stat. 708); Executive Order 11751 (38 FR 34725); and Part 73 of the Regulations of the Office of the Secretary of Transportation (49 CFR Part 73).

**Effective date.** This action is effective 2 a.m. central nonadvanced (standard) time Sunday, January 6, 1974.

Issued in Washington, D.C., on January 4, 1974.

CLAUDE S. BRINEGAR,  
Secretary of Transportation.

[FR Doc. 74-767 Filed 1-9-74; 8:45 am]

[OST Docket No. 24, Notice No. 74-3]

#### IDAHO AND OREGON

##### Emergency Daylight Saving Time Exemptions

The Emergency Daylight Saving Time Energy Conservation Act of 1973 (December 15, 1973, Pub. Law 93-182) (“the Act”) advances the standard time by one hour in all eight standard time zones of the United States continuously from 2:00 a.m. Sunday, January 6, 1974, to 2 a.m. Sunday, April 27, 1975, and provides that the time as so advanced shall be standard time.

Two classes of States are permitted to exempt themselves from advanced time: (1) any State which is entirely within one time zone and not contiguous to any other State (Hawaii, Puerto Rico, and the Virgin Islands); and (2) any State with part thereof in more than one time zone (Alaska, Florida, Idaho, Indiana, Kansas, Kentucky, Michigan, Nebraska, North Dakota, Oregon, South Dakota, Tennessee, and Texas). (Section 3(a)). If a State elects to exempt itself, the exemption must apply to the entire area of the State lying within one time zone, and the effect of the exemption must be to put the entire State on uniform time (i.e., the exemption can only apply to that part of the State in the more easterly zone) (see H. Rept. No. 93-709 at 5).

Section 3(a) permits States to exempt themselves from advanced time by law enacted anytime during the period the Act is in effect. The exemption must, however, be complete; a State may not elect to exempt itself from advanced time during winter months but observe advanced time during summer months.

Section 3(b) of the Act permits the President to grant a State an exemption from the advanced time established by section 3(a) of the Act or a request for realignment of the existing limits of time zones, if the State, by proclamation of

its Governor, makes a finding prior to Sunday, January 6, 1974—the effective date of the Act—that such exemption or realignment is necessary to avoid undue hardship to large segments of the population or part thereof. (“[The President’s] decision should be based on the appropriateness of all aspects of any exemption, including convenience of commerce, possible energy savings, or undue hardship to large segments of the population, as well as the possible impact on the success of and cooperation with the national energy conservation program.” S. Rept. No. 93-504 at 3.)

By Executive Order 11751, issued December 15, 1973, the President has designated and empowered the Secretary of Transportation to exercise the authority vested in him by section 3(b) to grant the exemptions or realignments.

Procedures and criteria for implementation were issued by the Secretary (49 CFR Part 73, 38 FR 34876).

The Governor of the State of Idaho, the Honorable Cecil D. Andrus, by proclamation issued December 28, 1973, requests that the entire area of Idaho located within the mountain time zone be exempted from observance of advanced time during the effective period of the Act.

The Governor of the State of Oregon, the Honorable Tom McCall, by proclamation issued January 2, 1974, requests that any determination made with respect to the mountain time zone section of Idaho apply equally to that section of Oregon which is in the mountain zone (northern Malheur County), since failure to apply any Idaho exemption to this County would create an “island” one hour ahead of all surrounding areas.

The proclamation and supporting data submitted by the Governor of Idaho establish that the State is located on the boundary between the mountain and Pacific time zones; that the northern portion of Idaho is located in the Pacific time zone and the southern portion in the mountain time zone; that permitting the requested exemption would result in observance of a single time throughout the State; that energy conservation would not occur were advanced time observed in the southern portion; that winter daylight time observance would severely disrupt outdoor industry, such as forestry, and school operations in the southern portion of the State; and that commerce would not be disrupted.

Several television broadcasting companies operating within southern Idaho state that their services would be adversely affected if the requested exemption is granted. Their network programming is received through the mountain time zone, and they note that “prime time” broadcasts would occur between 5 and 9 p.m., if advanced time is not observed, rather than between 6 and 10 p.m., if advanced time is observed. The broadcasters state that purchase and use of tape delay equipment would not be economically feasible.

Other comments have been received from several Idaho residents generally supporting or opposing the requested exemption.

extreme hardship to school children, agriculture, and industry requiring daylight working conditions; that the convenience of commerce would be served by western Kentucky counties observing the same time as adjacent areas in Tennessee and Indiana; and that the proposed realignment would not be detrimental to the national energy conservation program. The data submitted also establish that the twelve counties which would remain in the eastern time zone are commercially related to adjacent areas in Ohio and West Virginia, and that the convenience of commerce would best be served by their continued observance of the same time as those areas.

Although section 3(a) of the Act contemplates State legislative action to achieve an exemption from observance of advanced time within one time zone of a State with parts in more than one zone, the proposed realignment may be obtained only under section 3(b).

Upon consideration of the proclamation and supporting data, I find the requested realignment of the limits of the eastern and central time zones within Kentucky is consistent with the objectives sought to be achieved by the Act. During the effective period of the Act, therefore, the limit between the eastern and central time zones in the Commonwealth of Kentucky shall be defined as follows:

From the junction of the east line of Spencer County, Indiana, with the Indiana-Kentucky boundary northerly and easterly along that boundary to the west line of Boone County, Kentucky; thence southerly along the west line of Boone County to the north line of Grant County; thence west along the north line of Grant County to the west line of Grant County; thence southerly along the west line of Grant County to the south line of Grant County; thence easterly along the south lines of Grant and Pendleton Counties to the west line of Bracken County; thence south along the west line of Bracken County to the south line of Bracken County; thence easterly along the south lines of Bracken, Mason, Lewis, and Carter Counties to the west line of Lawrence County; thence south along the west line of Lawrence County to the south line of Lawrence County; thence easterly and northerly along the south line of Lawrence County to its junction with the Kentucky-West Virginia boundary; thence southerly along the Kentucky-West Virginia boundary to the Kentucky-Tennessee boundary; thence west along the Kentucky-Tennessee boundary to its junction with the west line of Scott County, Tennessee.

Because of the emergency nature of the Act; the Congressional intent that it be implemented quickly;<sup>1</sup> the short period of time between its enactment December 15, 1973, and its taking effect January 6, 1974; and the short period of time between the date of the proclamation—January 3, 1974—and January 6, 1974, I find that notice and public procedure on this action are contrary to the public interest and that good cause

<sup>1</sup> “[The Secretary] should act quickly and expeditiously. Failure to do will risk serious inconvenience and uncertainty.” See Senate Report No. 93-504 at 2.

exists for making it effective in fewer than 30 days after publication in the FEDERAL REGISTER. For these same reasons it has not been possible to assess the need for, and, if necessary, to prepare an environmental impact statement on this action. See section 102, National Environmental Policy Act of 1969 (January 1, 1970, Public Law 91-190, section 102, 83 Stat. 853; 42 U.S.C. 4332).

This action is taken pursuant to section 3(b) of the Emergency Daylight Saving Time Energy Conservation Act of 1973 (December 15, 1973, Pub. Law 93-182, section 3(b), 87 Stat. 708); Executive Order 11751 (38 FR 34725); and Part 73 of the Regulations of the Office of the Secretary of Transportation (49 CFR Part 73).

**Effective date.** This action is effective 2 a.m. central nonadvanced (standard) time Sunday, January 6, 1974.

Issued in Washington, D.C., on January 4, 1974.

CLAUDE S. BRINEGAR,  
Secretary of Transportation.

[FR Doc. 74-787 Filed 1-9-74; 8:45 am]

[OST Docket No. 34, Notice No. 74-3]

#### IDAHO AND OREGON

##### Emergency Daylight Saving Time Exemptions

The Emergency Daylight Saving Time Energy Conservation Act of 1973 (December 15, 1973, Pub. Law 93-182) (“the Act”) advances the standard time by one hour in all eight standard time zones of the United States continuously from 2:00 a.m. Sunday, January 6, 1974, to 2 a.m. Sunday, April 27, 1975, and provides that the time as so advanced shall be standard time.

Two classes of States are permitted to exempt themselves from advanced time: (1) any State which is entirely within one time zone and not contiguous to any other State (Hawaii, Puerto Rico, and the Virgin Islands); and (2) any State with part thereof in more than one time zone (Alaska, Florida, Idaho, Indiana, Kansas, Kentucky, Michigan, Nebraska, North Dakota, Oregon, South Dakota, Tennessee, and Texas). (Section 3(a)). If a State elects to exempt itself, the exemption must apply to the entire area of the State lying within one time zone, and the effect of the exemption must be to put the entire State on uniform time (i.e., the exemption can only apply to that part of the State in the more easterly zone) (see H. Rept. No. 93-709 at 5).

Section 3(a) permits States to exempt themselves from advanced time by law enacted anytime during the period the Act is in effect. The exemption must, however, be complete; a State may not elect to exempt itself from advanced time during winter months but observe advanced time during summer months.

Section 3(b) of the Act permits the President to grant a State an exemption from the advanced time established by section 3(a) of the Act or a request for realignment of the existing limits of time zones, if the State, by proclamation of

its Governor, makes a finding prior to Sunday, January 6, 1974—the effective date of the Act—that such exemption or realignment is necessary to avoid undue hardship to large segments of the population or part thereof. (“[The President’s] decision should be based on the appropriateness of all aspects of any exemption, including convenience of commerce, possible energy savings, or undue hardship to large segments of the population, as well as the possible impact on the success of and cooperation with the national energy conservation program.” S. Rept. No. 93-504 at 3.)

By Executive Order 11751, issued December 15, 1973, the President has designated and empowered the Secretary of Transportation to exercise the authority vested in him by section 3(b) to grant the exemptions or realignments.

Procedures and criteria for implementation were issued by the Secretary (49 CFR Part 73, 38 FR 34876).

The Governor of the State of Idaho, the Honorable Cecil D. Andrus, by proclamation issued December 28, 1973, requests that the entire area of Idaho located within the mountain time zone be exempted from observance of advanced time during the effective period of the Act.

The Governor of the State of Oregon, the Honorable Tom McCall, by proclamation issued January 2, 1974, requests that any determination made with respect to the mountain time zone section of Idaho apply equally to that section of Oregon which is in the mountain zone (northern Malheur County), since failure to apply any Idaho exemption to this County would create an “island” one hour ahead of all surrounding areas.

The proclamation and supporting data submitted by the Governor of Idaho establish that the State is located on the boundary between the mountain and Pacific time zones; that the northern portion of Idaho is located in the Pacific time zone and the southern portion in the mountain time zone; that permitting the requested exemption would result in observance of a single time throughout the State; that energy conservation would not occur were advanced time observed in the southern portion; that winter daylight time observance would severely disrupt outdoor industry, such as forestry, and school operations in the southern portion of the State; and that commerce would not be disrupted.

Several television broadcasting companies operating within southern Idaho state that their services would be adversely affected if the requested exemption is granted. Their network programming is received through the mountain time zone, and they note that “prime time” broadcasts would occur between 5 and 9 p.m., if advanced time is not observed, rather than between 6 and 10 p.m., if advanced time is observed. The broadcasters state that purchase and use of tape delay equipment would not be economically feasible.

Other comments have been received from several Idaho residents generally supporting or opposing the requested exemption.

# SUBJECT INDEX

## A

	Page
A. 1 time (USNO).....	320
Abbreviations	
international organizations.....	324
time and frequency listing.....	458
Absolute frequency.....	321
Absorption.....	72, 131
beam.....	131, 132
cell.....	84, 130
frequency, electromagnetic.....	128
laser radiation, simple.....	131
microwave.....	97
probability.....	78
saturated.....	129, 133, 134, 142
iodine.....	131
methane.....	107, 131
A-C power utilities in the continental U.S.....	298
ACAS (Aircraft Collision Avoidance System), T/F.....	288
commercial.....	289
evaluation for TFD.....	289
ground timing system.....	289
walk-in T/F service.....	289
Acceleration, stress, vibration (crystal units).....	50, 61
Accessibility, UTC(NBS).....	221, 222
Accuracy.....	81, 103, 124, 153
AT-NBS time scale.....	219, 220
atomic time scale.....	4, 219
algorithms.....	215
AT(NBS).....	220, 322
construction and maintenance.....	207
NBS.....	113, 219
TAI.....	27, 207, 223
USNO (A. 1).....	322
capability	
frequency standards.....	124, 127, 133
historical developments.....	139
NBS-III (1969).....	115
NBS-5 (preliminary error budget 1973).....	124
SI base units.....	140
cesium.....	81, 95, 104, 113, 124
clock.....	277, 317
date transfer.....	300
definition.....	139, 153, 238, 317
dissemination (T/F) techniques.....	300
frequency	
standards.....	96, 104, 113, 124, 139
synchronization.....	300
laboratory cesium standards and precision of clock rate or	
frequency standards.....	104, 208
levels of service (satellite).....	277
operation skill required for T/F comparisons.....	302
primary frequency standards.....	113, 121, 127, 146
rate of AT(NBS) time scale.....	219, 223
received, radio broadcast carrier.....	282
synchronization.....	208
TAI time scale.....	223
time.....	153
WWV broadcast transmissions.....	247
accuracy users (TFD)-low, intermediate, high.....	299
Acoustic loss (crystal).....	46, 59
Active device.....	72, 78
Active-line TV.....	265
capabilities and limitations for TFD.....	267
experiment.....	267
Active maser oscillator.....	128
Additive noise.....	54, 240
Advanced T/F systems using radio techniques.....	284

	Page
Advantages of T/F dissemination techniques	
a-c power (60-Hz).....	299
aircraft flyover.....	294
commercial (stabilized) broadcasts.....	282
hardwire distribution systems (telephone, coax line).....	297
HF broadcasts.....	251
LF broadcasts.....	246
Loran-A navigation system.....	257
Loran-C navigation system.....	256
MBTS system.....	287
microwave system (SHF).....	282
Omega navigation system.....	253
portable clock method.....	292
pulsar optical time transfer.....	296
satellites.....	280
television methods.....	264, 265, 267
TF-ACAS.....	289
VHF reflection from meteor trails.....	284
VLBI clock synchronizations.....	285
VLF broadcasts.....	244
AEP (American Electric Power) Co.....	298
Aging.....	48, 49, 61, 167
clock.....	208
crystal.....	48, 49, 61, 290
frequency.....	158
rate.....	49, 167
time.....	48
Aircraft Collision Avoidance System (see ACAS)	
Aircraft flyover synchronization.....	293
evaluation for TFD.....	294
one-way method.....	294
two-way method.....	294
Algorithms	
atomic time scale.....	215
first and second order time scale.....	216
mini-computer program.....	227
time prediction.....	214
Allan variance.....	114, 123, 157, 165, 209
computing counter program.....	182
discussion.....	165
equation.....	166, 178
sample calculation.....	181
Ambiguity.....	238, 300
cycle (VLF).....	243
position, navigation.....	251
power system (60-Hz).....	299
American Electric Power (see AEP)	
Ammonia	
beam maser.....	92, 131, 133
clock.....	93, 140
inversion transition.....	92
maser.....	92
Amplifiers, operational.....	169
low noise.....	169
Amplitude distribution.....	46
Analog	
spectrum analyzers (frequency domain).....	164
to digital converter.....	168
voltage.....	164
Angular momentum	
electron.....	69, 71, 73
total.....	76
Anharmonic overtone, quartz.....	60
Antenna pointing charts (satellite).....	277
APC (Automatic Phase Corrector) telephone lines.....	297
Apparent solar time.....	5
Applications, line of sight radio dissemination.....	240
Astronomical time.....	13
scale.....	5

	Page
Astronomy stations (USNO)	
Richmond, Florida (near Miami).....	321
Washington, D.C.....	320
Asymmetry, spectral.....	128
AT(atomic time).....	7, 223
AT(NBS).....	207, 214, 222, 262
accuracy rate.....	219, 220, 224
calibration with NBS-5 frequency standard.....	220
clock ensemble.....	215
rate measurement system (chronograph).....	215
time scale.....	207, 214, 223, 264
errors of 6 selected cesium clocks.....	219
overview.....	207
system.....	214
block diagram.....	214
AT-cut plates, quartz crystal units.....	44, 59
Atomic	
beam.....	67, 83, 87, 88
cesium.....	80, 87, 121
Dunoyer's apparatus.....	87
frequency standards.....	67, 71, 83, 93, 96, 103, 113
Frisch-Segre technique.....	88
magnetic resonance techniques.....	87
techniques.....	88
thallium devices.....	87, 96
tubes (cesium).....	127
clock.....	4, 207, 317
cesium.....	140
world's first (ammonia).....	93, 140
worldwide synchronization.....	290, 294
frequency	
control of HF radio broadcasts (emissions).....	251
energy levels.....	67, 69
standards.....	67, 72, 83, 87, 113, 121, 127
availability.....	103
capability.....	143, 302
historical development.....	87, 103
increasing use.....	103
major examples.....	78
physical basis.....	67
recent progress in development.....	103
side by side comparison.....	95, 290
state of the art.....	104, 113, 121, 214
hydrogen	
hyperfine splitting.....	91
maser.....	87, 97, 105, 113
properties.....	70
spectra.....	73
state, change of.....	71, 88
time.....	7, 95
time scales	
(also see Time scales).....	7, 207, 320
differing techniques for construction and maintenance.....	207
NBS-generation, stability, accuracy and accessibility.....	207
NBS system, AT(NBS).....	214, 320
TAI (see TAI)	
unit of time interval.....	95, 208
velocities.....	122
Atomichrons.....	95
Atoms.....	67, 71
alkali metals.....	77
barium oxide.....	131
cesium.....	77, 95, 153, 319
change of state.....	71, 90
criteria for choosing.....	73, 77
electrical charge.....	67
energy.....	68, 69, 73, 75-77
helium.....	68
hydrogen.....	70, 73, 74, 92, 98
energy level for ground electronic state.....	69, 91
interrogation of.....	127
magnetic moments.....	72, 77, 89
mercury.....	90, 131
nuclear.....	69

	Page
orbital angular momentum number.....	73
potassium.....	75, 88
energy level diagram for emission electron.....	75
properties.....	70
rubidium.....	77, 81, 97
silver.....	87, 88
sodium.....	87, 91, 96
spectra.....	73
thallium.....	96
velocity.....	72
ATS-1 (Applications Technology Satellite-1), NASA.....	272
VHF transponders.....	270
ATS-3.....	272
experimental work with satellite.....	276
timing studies.....	277
Audio tones (HF radio broadcasts).....	248
Auto-correlation functions.....	209
Automatic Phase Corrector (see APC)	
Automation system (time scales).....	219
Average	
clock.....	320
frequency.....	165
one second (frequency stability).....	133
sample, independent estimate of $S_y(f)$ .....	165
time.....	157
variance.....	165
<b>B</b>	
Balmer series.....	73
Bandwidth	
frequency measuring equipment.....	159
servo.....	169, 170
Baselines, widely separated (VLBI).....	284
Base units of measurements.....	10, 139, 140, 318
comparison of accuracy capability.....	140
Basic standards.....	127, 145, 319
Battery bias box (frequency stability measurements).....	169
Beam	
absorption in.....	131, 135
atomic (see atomic beam)	
atomic frequency standard.....	93, 131
broken-technique.....	92
cesium.....	80, 87, 94, 95, 107, 113, 121, 127
clock.....	290
laboratory device.....	93-95, 104, 214
particle.....	143
cryogenic source.....	107
double-system.....	116
hybrid optics.....	108
hydrogen standard.....	79, 94, 95, 105, 106, 131, 132
intensity.....	121
long.....	95
maser, storage.....	132
molecular.....	87
multiple.....	107
optics.....	105, 122
alignment.....	124
hybrid.....	108
particle system.....	141
reversal.....	104, 113, 114, 121
storage, principle.....	132, 135
tube.....	131, 133
barium oxide.....	131
cesium.....	87, 121, 127, 131, 133, 143
helium.....	131
hydrogen, storage.....	131-132
mercury.....	131
particle.....	143
smaller.....	107
storage.....	106, 131, 132, 135
thallium.....	87, 96, 131
traveling.....	131, 132

	Page
Beat-frequency technique.....	162
Bias.....	110, 123, 124, 127, 218
cavity phase difference.....	121, 123
collisions.....	130
corrections.....	134
deterministic.....	153
frequency.....	123, 130
correction.....	115
functions.....	160, 190
B <sub>1</sub> and B <sub>2</sub> (tables).....	192-204
general.....	161
variances.....	176
uncertainties.....	124, 128, 129
wall shift.....	134
Bibliography (also see reference listings at end of each chapter)	
atomic frequency standards.....	84
frequency stability.....	182
future trends in accurate frequency/time metrology.....	148
time scales and their formation.....	230
time/time scales.....	14
BIH (International Time Bureau).....	10, 19, 23, 33, 207, 223, 324
NBS/USNO interactions.....	321
UTC.....	10, 23, 25, 220, 322
BIPM (International Bureau of Weights and Measures).....	324
Black body radiation.....	68, 71
Bloch-Siegert	
effect.....	141
frequency shift.....	129
Bohr's	
model.....	67, 68
theory.....	70, 71, 74
Broadcasts.....	240, 319
atomic frequency control of HF.....	251
carrier, received accuracy.....	282
format of WWV, WWVB, WWVH.....	246, 249
location of stations for TFD service.....	241
NBS, standard frequency.....	247, 321
reference for NBS T/F.....	207, 248, 319
stabilized carrier (commercial).....	282
standard time and frequency (emissions).....	31, 238
allocated band (chart).....	311
outside allocated band (chart).....	312
U.S. Navy time signal.....	321
Broken-beam technique.....	92
Buffer gas.....	82, 96, 132, 142
techniques.....	91, 97
Bureau International de l'Heure (see BIH)	
Bureau International des Poids et Mesures (see BIPM)	

## C

c (velocity of light), defined value.....	127, 145
C-fields.....	79-81, 89, 115
Calendars.....	317
Calibration	
AT(NBS) time scale with NBS-5.....	220
cost.....	301
delay.....	238
frequency.....	114
standard.....	214
local standard.....	267
microwave frequency stability.....	173, 187
NBS-III primary frequency standard.....	113, 214
NBS-5 primary frequency standard.....	121, 215
precision.....	218
PTTI standards/facilities.....	365, 371
remote oscillator.....	267
Capabilities, time dissemination techniques.....	300
Cathode ray experiment (electron).....	67
Carrier-to-noise ratio.....	161

	Page
Cavity.....	81, 128
coupling.....	173
discriminator.....	173
phase-difference bias.....	121, 123
phase shift.....	104, 124
offsets.....	130
pulling.....	98, 128, 129
effects.....	106
frequency shift.....	98
Q.....	173
Ramsey type.....	113, 121, 130
resonance.....	129
CCDS (Consultative Committee for the Definition of the Second).....	10, 324
recommendations at 6 <sup>th</sup> session.....	39
CCIR (International Radio Consultative Committee).....	323, 324
Recommendation 460.....	31
Study Group 7.....	324
Celestial navigation.....	6, 11, 317
motion of bodies.....	320
Cell, absorption.....	84, 130
Cesium.....	77, 80, 94-96, 103, 122
accuracy.....	81, 96, 104, 113, 121, 133, 146
atom.....	77, 95, 153, 319
atomic beam.....	80, 87, 94, 98, 127, 145
commercial.....	95, 96, 107
device.....	87
transition.....	81, 95, 319
tube.....	127, 134
beam diagram.....	80
clock.....	218, 290
performance.....	140
time errors.....	219
gas cell standard.....	96
oscillator.....	263
particle beam tube.....	143
resonance frequency.....	81, 127, 319
reference.....	87, 267
standard.....	95, 113, 121
transition frequency.....	81, 95, 122, 127
Cesium beam standard.....	80, 87, 103, 107, 127, 145, 214
commercial.....	95, 96, 107, 114, 290
improvements.....	95, 108
early forms.....	93-95
electronic systems.....	105, 114, 121
frequency.....	67, 87, 113, 145
high-performance tube.....	108
laboratory device.....	94, 103, 121, 145, 214
accuracy trends (1956-1973).....	104
state-of-the-art.....	104, 121
C-fields.....	79-81, 89
errors.....	105
longitudinal.....	105
structure.....	108
CGPM (General Conference of Weights and Measures).....	10, 17, 323
Chains, frequency multiplier.....	114, 122
Change of state-atoms.....	71
Characteristics	
broadcasts (F/T) in allocated bands.....	311
emissions (F/T) outside allocated bands.....	312
frequency stabilized navigation systems.....	313
Loran-C stations.....	254, 313
radio frequency bands 4 to 10.....	310a
Characterization of frequency stability.....	154
Charge distribution for ground states of several elements.....	75
Charge to mass ratio.....	67, 69
Chief of U.S. Naval Operations, transferring responsibility.....	349
Chronograph-AT(NBS) rate measurement.....	215
Chronometer.....	13
CIPM (International Committee of Weights and Measures).....	323



	Page
Circuit, electrical equivalent (quartz crystal).....	44, 59
Circular slide rule (satellite propagation delay).....	277, 278
Classification of time and frequency users.....	299
Clock.....	3, 4, 93, 94, 114, 140, 153, 208, 290, 317
aging.....	208
ammonia.....	93, 140
atomic.....	140, 317
scale, international comparison.....	291, 294
average.....	320
cesium.....	219
commercial.....	219
time errors.....	140, 223
performance.....	216
characterization.....	95, 218
commercial cesium.....	321, 381
coordination.....	153, 208, 235, 317
definition.....	215
ensemble.....	215
AT(NBS).....	216, 218
frequency stability.....	114
NBS.....	219
primary function.....	219
time dispersion.....	161, 209
errors.....	93, 140
first atomic.....	95, 290
“flying experiment”.....	209
frequency drift.....	240, 271, 379
master.....	272, 379
USNO.....	208, 224
modeling.....	212
noise characterization.....	269, 271, 273
on-board, satellite.....	216
on-line.....	292
on-site visits.....	227
“paper”.....	95, 290
portable.....	218, 290
quartz crystal.....	290
first.....	209
random perturbation of time.....	208
rate/frequency, accuracy and precision.....	253
resynchronization of remote.....	254, 271
slave.....	153, 208, 238, 295, 317
synchronization.....	208, 277
accuracy.....	238
basic techniques of system.....	243
initial.....	285
intercontinental precision.....	259, 262, 277
remote locations.....	271, 290
widely separated.....	128
transition.....	297
Coax.....	297, 298
cable distribution, T/F signals.....	297
evaluation of hardwire systems for TFD.....	297
transmission of phase data over lines.....	297
Codes.....	250
IRIG-H time.....	34
transmission of DUT1.....	248
WWV – 100 Hz.....	246
WWVB – time.....	237
Coherent communications systems.....	121
Collimator, oven.....	91
Collision-narrowing effect (buffer gases).....	91
Color subcarrier (see television)	
Commercial-radio broadcast.....	282
TFD technique.....	282
evaluation for TFD.....	
Commercial frequency standard.....	95, 96, 107, 114, 290
cesium.....	97, 108
rubidium.....	276
Communication satellites.....	13, 318
Compromise time scale.....	

	Page
Computer (frequency stability measures)	
analysis, time data .....	170
on-line processing .....	215
program (Allan variance) .....	182
Concepts	
dissemination, T/F .....	235
frequency stability .....	156
primary frequency standards .....	133
time .....	4
time and frequency .....	10, 208
Confidence of the estimate .....	164
Confinement techniques .....	129, 141
Confining particles (effects on frequency) .....	129, 130
Conservation of charge .....	71
Conservation of electromagnetic spectrum .....	257, 302
Consultative Committees (International) .....	324
Continental drift .....	284
Contours, satellite path delay .....	277
Convergence, power law spectral densities .....	165
Conversion	
chart-stability measures (Frequency domain-time domain) .....	166
fractional frequency to time stability .....	222
Converter	
analog to digital .....	168
voltage to frequency .....	170
Coordinate time scale, UTC(NBS) .....	207, 220
Coordinate Universal Time (see UTC)	
Coordinates of the pole .....	323, 384
Coordination agreement (NBS/USNO time scales) .....	220, 381, 382
Corpuscular theory .....	71
Corrections	
lunar topography (TFD) .....	287
VLF broadcasts .....	243
Cost, users' effectiveness (dissemination techniques) .....	222, 238
Counters	
computing-time domain measurements .....	174
frequency .....	157, 163, 167
Crab Nebula Pulsar .....	294
Criteria, frequency standard characteristics .....	77
Cryogenic beam source .....	107
Crystalline body vibration .....	60
Crystals (also see Quartz crystals) .....	43, 59
Cycle	
identification (VLF) .....	243, 252
per second (Hertz) .....	10, 70, 140
slip (low frequency radio) .....	245
<b>D</b>	
Data	
analysis (T/F) statistical .....	153, 181
concepts for primary frequency standards .....	133
filtering .....	216
simulation .....	212
translation from frequency domain to time domain .....	178
uniform methods of reporting .....	175
Date .....	4, 153, 208, 235, 317
accuracy of transfer .....	300
events of a leap second .....	34
DC resistance-phase sensitivity (hardwire TFD) .....	297
Dead time in the frequency stability measurement process .....	164
Decoders, IRIG time code .....	250
Dedicated telephone lines (TFD) .....	297
Defense Satellite Communication System (see DSCS)	
Definitions	
accuracy .....	139, 153, 238
clock .....	3, 153, 208, 317
date .....	4, 153, 208, 317
deviations, random/non-random .....	153
epoch .....	4, 153, 208, 317

	Page
equation of time.....	6
frequency.....	10, 70, 140, 153, 237
frequency stability.....	154
measures of.....	156
hertz.....	10, 70, 140
identification (TFD).....	238
leap second.....	9, 34, 220
precision.....	154
reproducibility.....	154
second.....	11, 17, 127, 139, 140, 153, 209, 319
simultaneity.....	4, 153, 208
stability.....	154, 155
statistical models.....	155
synchronization.....	4, 153, 208
time.....	5, 153, 371
astronomical.....	5, 13
atomic.....	7
ephemeris.....	6
GMT.....	6
interval.....	10, 208, 371
sidereal.....	6
SI unit.....	17, 208
TAI.....	10, 19, 27
UT0.....	5
UT1.....	6
UT2.....	6
UTC.....	8
UTC(BIH).....	10, 26
time scale.....	4, 207, 317
Delay	
computer, satellite.....	277
differential.....	298
path.....	270, 277
radio propagation.....	240, 259
satellite	
motion variability.....	271
path contours.....	277
theoretical prediction (propagation).....	243
time, propagation.....	237, 238, 269
Demodulator (FM).....	173
Densities, spectral (also see spectral density).....	156, 157, 177, 178
Description of radio frequency bands 4 through 10.....	310a
Detection of particles.....	78, 128
Deterministic	
biases.....	173
properties.....	208
Deviations	
frequency, quartz crystal.....	50
random/non-random.....	153
Dielectric constants, quartz material.....	45
Difference frequency.....	167, 243
Differential	
delay.....	298
measurements (TV, line-10).....	260
path delay.....	259
phase noise measurements.....	171
Digital time dissemination.....	266
Dipole transitions.....	130
Director of NBS, responsibilities.....	318, 335
Discriminator	
cavity.....	173
frequency.....	164
Dispersion	
frequency.....	244
time.....	219, 220
Dissemination	
compromises in choosing a service.....	302
concepts.....	235
system.....	239
characteristics.....	237

	Page
Dissemination (T/F) techniques.....	221, 222, 235
Aircraft Collision Avoidance System (ACAS).....	288
aircraft flyover.....	293
coax cable.....	296
commercial radio broadcasts.....	282
HF radio broadcasts.....	247
LF radio broadcasts.....	245
Loran—A navigation system.....	257
Loran—C navigation system.....	222, 253
meteor trail.....	283
microwave signals.....	281
Moon Bounce Time Synchronization (MBTS).....	286
Omega navigation system.....	251
portable clock.....	290
power line (60 Hz) system.....	222, 298
pulsar optical time transfer.....	294
radio methods.....	239
satellites.....	222, 223, 269
telephone lines.....	296
television systems (TV).....	222, 259
Very Long Base Interferometry (VLBI).....	284
VLF radio systems.....	241
Dissemination (T/F) techniques, comparison-evaluation.....	301
fractional frequency stability vs function of sample time.....	221
Dissymmetric modes, crystal.....	48
Distance gap between T/F source and user.....	235
Diurnal changes	
phase, low frequency.....	242, 245, 310a
resistance of phone line.....	296
Diversity techniques, radio reception.....	247
DOD directive No. 5160 (T/F responsibilities).....	320, 365
Doppler	
effect.....	98, 141, 143, 269
first order.....	81, 130, 133, 141, 142
second order.....	121–124, 141
measurements.....	273
radar.....	161
ranging.....	288
shift.....	80, 115, 130, 271
second order.....	105, 115, 130, 131, 142
Double-beam system (atomic frequency standard).....	116, 121
Double resonance techniques.....	90, 96
Drift.....	43, 48
compensation, quartz crystal.....	50, 61
continental.....	284
correction.....	290
frequency.....	167, 210
linear.....	158, 167
long-time, quartz crystal.....	48
rates.....	43, 158, 209
Drive level, crystal frequency stability.....	50, 61
DSCS (Defense Satellite Communication System).....	276
network.....	281
timing tests.....	276
Dual rate moon camera.....	320
Dunoyer's atomic beam apparatus.....	87
DUT1.....	33, 245
transmission code.....	35

## E

Earth	
coverage by satellites.....	269
magnetic field.....	79
orbital motion.....	285
rotation rate.....	7
satellite (TFD).....	269
sun, moon relationships.....	5
Einstein	
photoelectric effect.....	68
theory of special relativity.....	71

	Page
Elastic constants, crystal.....	45
Electrical	
charge-atoms.....	67
equivalent circuit, quartz.....	44, 59
Electromagnetic (EM)	
absorption frequency.....	71, 128
field, energy of.....	68, 71
radiation.....	68, 71
spectrum, conservation of.....	257
wave.....	71
Electron.....	67, 69, 70, 74, 130
angular momentum.....	71, 73
collisions.....	130
emission.....	75
intrinsic magnetic moment.....	70, 71
mass.....	69
spin.....	71, 73, 88
velocity.....	69
Electronic	
frequency standards, quantum.....	127, 131
problems, laboratory cesium beam standards.....	105, 121
systems.....	95, 114
Electrostatic	
magnetic forces.....	74
state separator.....	92
Emergency daylight saving time.....	408, 411
Emission	
electrons.....	75
probability.....	78
spectral, lines.....	88
spontaneous.....	72, 128
Enclosures, crystal.....	44, 45, 61
Energy.....	67, 129-131
atoms.....	68, 69
difference.....	76
electromagnetic (EM) field.....	68, 72
levels.....	73, 75, 76, 78, 88, 130
atomic frequency.....	67, 69
cesium.....	81
hydrogen atom.....	69, 73, 76, 79, 98
lithium.....	89
many-electron atom.....	73
mercury.....	90
potassium.....	75, 88
rubidium.....	82, 97
shifts.....	129
spin-additional.....	70
transitions.....	69, 71, 72, 74, 88, 90
states.....	67, 131, 141
total E.....	69
transition states.....	88
trapping, crystal units.....	46, 48, 60
Ensemble	
clock.....	215, 218-220
devices.....	154, 155
AT(NBS) clock.....	215
time, calculation.....	216
Envelope timing measurements (VLF).....	252
Environment (oscillator signal generators).....	52, 155
Ephemeris reference tables, time of coincidence (TOC)	
Loran-C.....	255, 384
TV.....	263, 384
Ephemeris Time (see ET)	
Epoch.....	4, 153, 208, 317
Equation of time.....	6
Equatorial satellite.....	269
Ergodicity.....	155
Errors	
clock.....	161, 219
Loran-C timing.....	256
signal processing equipment.....	164
wall shift.....	79, 98, 106, 134

	Page
ET (Ephemeris time) .....	6, 95, 317
Evaluable primary frequency standards.....	207, 219, 223
Evaluation	
NBS-III.....	113
NBS-5.....	121, 215
time and frequency users and systems.....	300
Exchange spin.....	129, 130
Excitation	
frequency.....	89, 93
pulsed microwave.....	104
state levels.....	90
Experimental work	
ATS-3 satellite.....	277
Exponential	
prediction.....	213, 218
weighting filter.....	212
<b>F</b>	
Factors affecting radio propagation.....	310a
FAGS (Federation of Astronomical and Geophysical Services).....	324
FC-cut (crystal).....	60
Federation of Astronomical and Geophysical Services (see FAGS)	
Figure of merit .....	116, 128
Filter	
adjustable RC.....	169
exponential weighting.....	212
low pass.....	162, 171
optimum.....	210, 212
flicker.....	226
various noise processes.....	225
recursive.....	226
First	
ammonia clock.....	93, 140
order	
Doppler shift.....	98, 130, 133, 142
time scale algorithm.....	216
minicomputer program.....	227
quartz crystal clock.....	290
Flexure (crystal units)	
shear modes.....	44, 59
type.....	49
Flicker-frequency noise.....	114, 178
Flicker noise.....	62, 158, 226
flicker of phase and DC.....	62, 114
frequency modulation (FM).....	7, 158, 210-213, 298
time dispersion with recursive filter.....	226
predictors for.....	213
Fluctuations	
measure of phase (frequency domain).....	114
oscillator frequency.....	54
random.....	166
Flux of signal particles.....	128
“Flying clock measurements”.....	95, 290
FM noise.....	164
Foamed mounting (quartz units).....	52
Focusing magnets.....	104
Formats	
HF radio broadcasts.....	247
Loran-C navigation system.....	255
Omega (proposed).....	253
WWV, WWVH broadcasts.....	249
WWVB one-minute time code.....	246
Fourier	
frequencies.....	156
transformations.....	158, 179, 210

	Page
Fractional frequency	
conversion to time stability.....	222
differential deviation, pulsars.....	295
fluctuation spectral density.....	166
offsets.....	8, 209
stability.....	114-116, 128, 156, 216, 217
power line (60 Hz) data.....	299
relative.....	114
versus sample time for several TFD techniques.....	265
TAI.....	223
television	
color subcarrier measurements.....	265
line-10 data.....	261, 262
Frequency.....	10, 43, 60, 70, 127, 140, 153, 208, 237
absolute.....	321
stabilization of a TV transmission.....	263
accurate measurements.....	140-142
survey.....	142-144
aging.....	158
averaging.....	165
basic concepts.....	10, 208
beat or difference.....	162, 167
bias.....	123
correction.....	115
broadcasts (standard).....	240, 241
calibration.....	114, 121
cesium	
beam.....	93, 113
transition.....	81, 95, 122, 319
characteristics criteria.....	77
clock drift.....	209
comparison.....	292
zero-beat method.....	250
control (HF broadcasts).....	248
counters.....	157, 163, 167
cutoff.....	159
dependence of various "noise" types.....	167
deviation.....	50
error expander.....	168
difference.....	116, 243
discriminators.....	164
dispersion.....	244
time scale memory.....	220
dissemination (also see <i>Dissemination T/F techniques</i> ).....	235
domain.....	157, 211
measures of phase fluctuations.....	114, 155, 167, 168
translation to time domain.....	159
drift.....	167, 210
electromagnetic absorption.....	128
excitation.....	89
flicker noise.....	114, 178
fluctuations.....	164, 167
fractional.....	177
measurement.....	167
spectral density.....	54, 156, 165, 178
variances.....	164
free atom.....	78
hertz (unit of frequency).....	10, 70, 140
high transition.....	130, 134
hydrogen	
resonance.....	106
terms of cesium.....	98
transition frequency.....	107
infrared synthesis.....	142
lock, servo system.....	95, 114
measurements (also see <i>measurement freq.</i> )	
accurate.....	139
significance and impact.....	144
survey of selected throughout EM spectrum.....	143

	Page
microwave .....	71, 99, 142, 173
modulation (FM) .....	114
demodulator .....	173
white noise .....	210
multiplication .....	114, 167
multiplier chains .....	94
noise (see Noise) .....	158
offset .....	210
UTC from 1960 to 1972 .....	8
output .....	127
permanent change (crystal) .....	51
radiation .....	72
radio (RF) bands 4 to 10, description .....	310a
response .....	164
rubidium transition .....	82
shift keying (FSK) .....	244
shifts .....	97, 142
short-term changes .....	49
signal (carrier) variable .....	178
sources, high precision-state of the art .....	62
stability (see Frequency stability)	
stabilization	
commercial broadcast stations .....	282
TV color subcarrier .....	263
TV transmissions .....	262
standards (see Frequency standards)	
step .....	220
survey-accurate measurements .....	144
synchronization, accuracy of .....	300
temperature drift compensation .....	50
time	
Division (NBS) .....	319, 361
metrology .....	127, 140, 145, 148, 237
performance, precision quartz oscillators .....	49
signal emissions	
CCIR recommendation 460 .....	31, 32
in allocated bands .....	241, 311
outside allocated bands .....	312
transformation .....	128, 132
transition .....	77, 130, 141
unified standard .....	127, 145
white noise .....	115
window .....	164
zero-beat method of comparison .....	250
Frequency and time	
metrology .....	127, 140, 148, 195, 237
NBS Division responsibilities .....	319, 322, 361
USNO (Time Service) Division responsibilities .....	320, 322, 371
Frequency band, RF transmissions .....	310a
Frequency domain .....	155, 157, 168
analog spectrum analyzers .....	164
characteristics of various power laws .....	211
frequency stability .....	166
measurements .....	168
time domain .....	168
translation to time domain .....	159, 178
measures	
phase fluctuations .....	114
stability .....	178
Frequency stability .....	43, 60, 61, 105, 114, 123, 128, 154, 159, 165
applications of specifications and measurements .....	165
bibliography .....	182
calibration procedure, microwave .....	173
characterization of .....	154
clock ensemble .....	220
color subcarrier (TV) .....	265
concepts of .....	156



	Page
crystal oscillators .....	43, 48, 62
definition .....	154
fractional (see Fractional stability)	
measure (spectral density) .....	165
measurements	
definitions .....	157
hazards in .....	164
HF regions .....	168
microwave region .....	171, 188
calibration procedure .....	173, 187
techniques .....	162
X-band .....	174
one-second averaging .....	133
quartz crystal .....	43, 48, 62
statistical models .....	155, 209
summary of measures .....	165
systematic	
trends .....	158
variations .....	158
terminology specifications .....	165
translations among measures .....	159
chart-time domain	
frequency domain .....	166, 178
Frequency standards .....	62, 72, 77, 78, 87, 103, 113, 121, 127, 146, 208, 209
accuracy .....	95, 105, 113, 121, 214
capability .....	115, 124, 127, 133, 146
primary .....	121, 146
atomic (see Atomic frequency standards)	
beam .....	73, 80, 81, 88, 96
basic .....	144, 146, 319
cesium (see Cesium beam standard)	
characteristics criteria .....	77
commercial .....	95, 96, 98, 107
effects on frequency	
particle	
confinement .....	129
interrogation .....	128
preparation .....	131
frequency/temperature drift	
compensation (quartz) .....	50
future areas of promise for development .....	127
historical development .....	87
hydrogen (see Hydrogen)	
international comparisons .....	95, 290
laboratory .....	93, 94, 103, 113, 121, 146, 214
accuracy trend, 1956-1973 .....	104
stability performance data .....	105
Mean Time Between Failure (MTBF) .....	9, 96
National Bureau of Standards (NBS) .....	93, 94, 113, 121, 214
NBS-III .....	113
accuracy capability (1969) .....	115
NBS-5	
accuracy budget .....	124
(preliminary 1973)	
frequency stability .....	122
primary	
calibration .....	95, 97, 113, 121, 214
candidates for .....	146
concepts for .....	78, 133
evaluable .....	207, 223
improvements in .....	103, 113, 121
memory of the rate .....	223
NBS and measurement system .....	121, 214
quantum electronic .....	127, 131
secondary .....	78
stability .....	62, 105, 122
state of the art .....	104, 113, 121, 127, 214
thallium .....	87, 96
rubidium .....	82, 97
commercial .....	97, 108
USA .....	315

	Page
Frequency-time domain.....	157
Characteristics of various power law.....	211
chart translation.....	166, 178
measures of frequency stability.....	157, 168
techniques.....	168
translation among measures.....	159, 166, 178
Frequency-transitions (also see applicable atoms).....	77, 130, 140
coupling.....	130
particles.....	130, 134
Frisch-Segre atomic beam technique.....	88
Functions, auto-correlation.....	209
Fundamental constants	
base set of.....	139, 145
knowledge of.....	145
Future	
developments-crystal oscillators.....	55, 62
primary frequency standards.....	107, 127, 139
trends, accurate F/T metrology (Bibliography).....	148

## G

Gas cell.....	81, 87, 89-91, 97, 131-133
cesium.....	96
factors limiting performance.....	97
optically pumped.....	82, 90, 97, 132
maser.....	132
passive.....	132
rubidium.....	81, 89, 97, 131-133
standards.....	97, 132
temperature.....	97
General Conference of Weights and Measures (see CGPM)	
General theory of relativity.....	144
Generators, power utilities.....	237
Geometry of VLBI receiving sites.....	284
GEOS-II (satellite).....	272
Geostationary satellite.....	223, 271
Global	
geodesy.....	284
time synchronization.....	290, 294
Glossary of time and frequency symbols.....	176
GMT (Greenwich Mean Time).....	6, 11
Gradients, magnetic field.....	106
Gravitational	
potential, difference in.....	220
shifts, relativistic.....	271
Greenwich, England-meridian.....	11
Greenwich Mean Time (see GMT)	
Ground state, electron.....	69, 75, 90
Ground stations (ACAS)	
(walk in T/F service).....	289
synchronization.....	289
Groundwave radio signals.....	251, 282
range, Loran-C signals.....	256
stability, Loran-C signals.....	254, 256
Group Repetition Period (GRP), Loran-C.....	254, 256

## H

Hardwire systems, aerially mounted.....	298
Hazards in frequency stability measures.....	164
Helium ion storage technique.....	131
Hertz, unit of frequency.....	10, 70, 140
Heterodyne techniques.....	162
period measurements.....	163
HF (High Frequency) radio.....	247
atomic frequency control of broadcasts.....	251

	Page
broadcast formats.....	247
evaluation for TFD.....	251
optimum radio measurement procedures.....	250
propagation delay of radio signals.....	250
skywave radio signals.....	251
telecommunications systems, performance prediction.....	251
time/frequency dissemination.....	247
High accuracy T/F users.....	299
High performance cesium beam tube.....	108
Hops, skywave radio signals.....	250
Hybrid beam optics.....	108
Hydrogen.....	68, 77, 97, 113
atom	
emission spectrum.....	74
energy level.....	69, 73, 76
atomic hyperfine splitting.....	91
beam standard.....	97, 105, 106
frequency	
difference between standards.....	285
in terms of cesium.....	98
magnetic dipole transition.....	98
masers.....	79, 97, 98, 105, 113, 132, 216, 285, 296
atomic.....	97, 113
comparisons with cesium beam.....	216
deformable storage bulb.....	106
Harvard.....	98
large bulb.....	99, 105
historical development.....	92
inaccuracies.....	106
NP3 (NASA).....	216
clock ensembles comparison NP3/AT(NBS).....	217
Ramsey.....	98
spectrum.....	70, 73
spin exchange shifts.....	106
stability.....	106
standard.....	97, 105, 285
storage bulbs.....	79, 92, 97, 105, 134
transition frequency.....	79
wall shift.....	79, 98, 105
storage beam	
standard.....	105
transition curves.....	106
tube.....	106, 132
Hyperfine interaction.....	76
splitting.....	91
transition.....	127, 130

## I

IAU (International Astronomical Union).....	323, 324
IBS (Institute for Basic Standards), NBS.....	341
ICSU (International Council of Scientific Unions).....	323, 324
Identification (TFD).....	238, 244
Image rejection, predetection bandwidth.....	164
Improvements	
NBS cesium frequency standards.....	104, 113, 121, 220
phase noise characteristics, crystal oscillators.....	105
TAI scale.....	39, 223
Infrared	
effects.....	129
frequency synthesis.....	142
region (EM spectrum).....	127
Initial synchronization of clocks.....	243
Injection of T/F information into TV format.....	265
Instabilities.....	156
evaluation of a primary rate standard.....	219-220
frequency measures.....	167
Institute for Basic Standards (see IBS)	
Instruments, long-beam frequency standards.....	95
Interaction time-storage technique.....	91
Intercomparisons, hydrogen masers and cesium beam standards..	98
Interconnected power systems.....	298
Intercontinental synchronization of precise clocks.....	285, 291, 294

	Page
Intermediate T/F accuracy users.....	299
International Astronomical Union (see IAU)	
International Atomic Time Scale (see TAI)	
International Council of Scientific Unions (see ICSU)	
International Latitude Service (ILS).....	323
International organizations, standard time and frequency.....	323
International Polar Motion Service (see IPMS)	
International Radio Consultative Committee (see CCIR)	
International Science Radio Union (see URSI)	
International System of Units of Measurement (see SI)	
International Telecommunications Union (see ITU)	
International Union of Geodesy and Geophysics (see IUGG)	
International Union of Pure and Applied Physics (see IUPAP)	
Inter-Range Instrumentation Group (see IRIG)	
Interrogation	
atoms or molecules.....	127
electromagnetic (EM) field.....	127, 128
particle.....	127, 141
time.....	129
Intrinsic reproducibility.....	154
Iodine	
absorption of laser radiation.....	131
saturated absorption.....	131
transition.....	143
Ion storage.....	107
helium.....	131, 143
mercury.....	131
principle.....	133
Ionospheric propagation anomalies.....	240, 310a
IPMS (International Polar Motion Service).....	323, 324
IRIG (Inter-Range Instrumentation Group)	
decoders for time codes.....	250
time code.....	248
ITU (International Telecommunications Union).....	323, 324
IUGG (International Union of Geodesy and Geophysics).....	324
IUPAP (International Union of Pure and Applied Physics).....	324

## J

Josephson	
effect.....	127
phenomenon.....	145
Julian Day	
modified number.....	221

## K

Kirsch hyperfine-structure level separations.....	89
---	----

## L

Laboratoire Suisse de Recherches Hologères (see LSRH)	
Laboratory frequency standards	
cesium.....	94, 96, 103, 113, 121, 214
accuracy trend, 1956 to 1973.....	104
stability performance data.....	105
performance, stability.....	105, 116, 123
state-of-the-art.....	104, 113, 121
Lacey's method (frequency stability).....	122
Lane identification (navigation).....	252
Laser	
oscillator.....	129, 143
radiation	
simple absorption.....	131
sulfurhexafluoride.....	131
latitude stations (International— see IPMS).....	323
Lattice distortions in crystals.....	46

	Page
Leap second.....	9, 32, 220, 318
adjustments.....	32-34, 221
dating of events.....	34
Leap year.....	8, 318
“Legal” volt.....	145
Legislative Authority, NBS responsibilities.....	331
LES-6 (satellite).....	272, 276
LF (low frequency) radio signals.....	245
evaluation for TFD.....	246
pulse decay time measurements.....	246
single-frequency phase tracking.....	245
time and frequency dissemination.....	245
Length	
standard of.....	144
unified standard.....	145, 237
Librations of moon (effect on TFD).....	287
Light	
intensity (optical pumping).....	97
quantization.....	68
shift.....	97, 132
spectroscopy.....	71
wave theory.....	71
Light, speed of.....	127, 145
Limitations of dissemination techniques for TFD (see evaluation under various techniques).	
Line-of-sight	
applications.....	240
radio frequency propagation.....	269, 310a
transmission.....	240
Line-Q, particle confinement.....	129
Linear drift, crystal oscillators.....	43, 61, 158, 167
Linewidths.....	142
narrow.....	95
resonance curve.....	72
transition.....	78
Lithium nucleus.....	89
Local standard calibration.....	267
Local TV service areas.....	264
Long beam instruments (Cesium standard).....	95, 113
Long term stability, NBS-III.....	114
Long time drift, quartz crystals.....	48
Longitudinal C-fields.....	105
Loose phase-lock loop.....	169
Loran-A navigation system (HF).....	257
baseline of pairs.....	257
clock synchronization via.....	257
coverage map for stations.....	258
evaluation for TFD.....	257
pulse envelope.....	259
Loran-C navigation system (LF).....	253
basic and specific rates.....	256
basic unit.....	254
chains.....	254
characteristics of stations.....	254, 313
clock synchronization techniques.....	223, 256
coverage map of system.....	255
evaluation for TFD.....	256
groundwave range.....	256
null ephemeris table (TOC).....	255, 384
pulse-coded format.....	254
pulse group format.....	255
skywave propagation.....	256
synchronization of.....	254
time of coincidence (TOC) of signals.....	255
Loran triad.....	257
Low-accuracy T/F users.....	299
Low-altitude orbiting satellites.....	271
LSRH (Swiss Laboratory of Clock Research).....	98
Lunar	
topography, corrections for TFD.....	287
radar time synchronization (see MBTF)	

## M

	Page
M, sample time.....	165
Magnetic	
dipole transition.....	98
forces.....	74
moment.....	70-72, 77, 88, 89
nuclear.....	89
resonance technique, atomic beam.....	88, 89
shielding.....	92, 108, 121
Magnetic field	
earth's.....	79
gradient.....	106
properties.....	124
Magnets, focusing.....	104
Magnification factor.....	243
Maintenance of synchronization at remote sites.....	292
Majorana transitions.....	130
Mapping of exponents, $\mu - \alpha$ .....	160
Maps	
Loran-A (navigation system) coverage.....	258
Loran-C (navigation system) coverage.....	255
Omega (navigation system) stations.....	252
time zone	
USA.....	326
world.....	12
world-location of broadcasting stations useful for TFD.....	241
Masers.....	77, 79, 92, 97, 105, 132, 144, 146, 216
active oscillator.....	128
ammonia.....	92, 131, 133, 144
Harvard, large bulb.....	105
hydrogen (see Hydrogen maser)	
rubidium.....	131, 132
self-stimulation emission.....	79
stability.....	106
storage beam.....	132
techniques.....	92, 132
Mass, electron.....	69
Master	
clock.....	240, 271, 379
station, Loran-C.....	254
Maxwell's theory (EM radiation).....	69, 71
MBTS (Moon Bounce Time Synchronization).....	286
evaluation for TFD.....	287
Mean solar time.....	5, 6
Mean-square time error.....	210
Mean Time Between Failure (see MTBF)	
Measurements	
accurate frequency.....	140, 144
survey.....	143
AT(NBS) rate system.....	214
comparison techniques.....	167
differential, TV line-10 data.....	260
Doppler (radio).....	273
envelope timing (VLF).....	252
"flying clock".....	95, 290
frequency (also see Frequency measurements)	
domain (time domain).....	167-171
computing counter.....	174
fluctuations.....	167
stability.....	154-159
conversion chart.....	166, 178
operational systems-microwave region.....	171
translations.....	159, 160
TV color subcarrier.....	263
microwave.....	173, 188
period.....	163
phase (TV).....	268
power-shift.....	123
process "dead time".....	164
pulse-velocity distribution.....	123
quantum transitions.....	140
relativity.....	284
single-oscillator system.....	173

	Page
techniques for frequency stability.....	162
time.....	3
differences.....	218
physical.....	81
time devices since ~ 1000 AD.....	3
unified standard.....	127, 145
X-band frequency.....	171-173
<b>Mechanical</b>	
design of cesium beam standards.....	108, 121
vibration, crystal units.....	50, 61
Medium-altitude satellites.....	269
Memory-rate of NBS primary frequency standard.....	223
<b>Mercury</b>	
atom.....	90
ion storage.....	131
Meridian of Greenwich, England.....	11
Merit, figure of.....	116, 128
Meteor trail (burst) system.....	283
evaluation for TFD.....	284
phase stability.....	283
scatter, forward reflection.....	283
<b>Methane</b>	
saturated absorption.....	107, 131, 144
cell.....	84
Metrology (see Frequency and time)	
<b>Microwave</b>	
absorption.....	97
effects.....	71, 129
frequency.....	71, 99, 142
frequency stability measurements.....	171, 187, 188
calibration procedure.....	173
input power.....	104
optimum power.....	116
pulsed excitation.....	104
relay routing of TV networks.....	260
resonances.....	4
signal changes.....	107
spectrum.....	123
system drift.....	281
TD-2 system.....	260, 281
time and frequency transfer.....	281
evaluation for TFD.....	282
Mini-modem equipment (DSCS).....	276
Minimum-squared error of time prediction.....	212
Mise en pratique du temps atomique international (putting into use the TAI).....	21, 22
<b>Mission responsibilities</b>	
NBS.....	318, 331
USNO.....	319, 357
Mixer, double balanced.....	168
Modeling, clock.....	208
<b>Models</b>	
idealized.....	155
mathematical, propagation media.....	240
statistical.....	155
<b>Modes, crystal units</b>	
dissymmetric.....	48
flexure and shear.....	44, 59, 60
motion.....	42, 46, 59
Modified Julian Day number.....	221
<b>Modulation</b>	
frequency.....	114
sinusoidal.....	173
time pulse.....	246
Molecular beam technique (Stern).....	87
<b>Moment (electron).....</b>	70
magnetic.....	71, 77, 89
nuclear magnetic.....	89
<b>Momentum</b>	
particle.....	70
total angular.....	76

	Page
Monotonic function of time.....	163
Moon Bounce Time Synchronization (see MBTS)	
Moon	
earth, sun relationships.....	5
librations affecting TFD.....	287
Motions of celestial bodies.....	320
Mounting systems, crystal vibrator.....	45
MTBF (Mean Time Between Failure),	
cesium standards.....	9, 96
Multipair-telephone lines (TFD).....	296
Multipath effects, radio propagation.....	269, 310a
Multiple	
beams (frequency standards).....	107
frequency-VLF techniques.....	243, 253
Multiplication, frequency.....	167
Multiplier chains, frequency.....	96, 114, 122
Mutual reciprocity of reflected	
VHF signals.....	283

## N

Narrow linewidths.....	95
NASA-Application Technology Satellites	
(ATs).....	276
NASA orbital elements (satellite positions).....	277
National Bureau of Standards (see NBS)	
National Physical Laboratory (see NPL)	
National reference standards.....	104
National Research Council (see NRC)	
National Research Laboratory of	
Metrology (see NRLM)	
Natural quartz.....	45
Naval time signals.....	321
Navigation	
capability of present day communication system.....	302
celestial.....	6, 317
characteristics of frequency stabilized systems useful	
for time/frequency comparisons.....	313
Loran systems for TFD.....	253, 257
radio systems for TFD.....	239
Radux system.....	242
rho-rho system.....	251
timing relationship.....	252
Navigators time scale.....	318
Navy Navigation Satellite System (see NNSS)	
NBS (National Bureau of Standards)	
AT clock ensemble.....	215
atomic time scale.....	214, 320
broadcasts of standard frequency.....	321
cesium beam frequency standard.....	94, 105, 113, 121
clock ensemble.....	114, 217
coordination with USNO.....	220, 321, 377
enabling legislation.....	329
function.....	335
Institute for Basic Standards (IBS).....	341
mission.....	318, 331
organization and assignment of functions.....	339
organization chart.....	346
primary standards	
frequency and time.....	319
frequency measurement system.....	214
radio station WWV, WWVH.....	247
time and frequency	
activities.....	318
Division.....	319, 361
organization chart.....	319
publications.....	183, 383
responsibilities.....	361
TV time system.....	266
UTC, accessibility and coordinated time scales.....	207, 220, 221, 319



	Page
NBS-III cesium standard.....	113, 214, 223
NBS-5 cesium standard.....	105, 121, 215, 220
calculated and measured stability.....	121, 123, 221
evaluation (1973 preliminary).....	124, 215
system description.....	121
NBS-X4.....	105, 121, 124, 215, 221
Needs, time and frequency.....	300, 302
Network (TV) reroutes.....	261
NNSS (Navy Navigation Satellite System).....	273
Noise.....	54, 62, 72, 128, 156, 159, 207, 244
additive.....	54, 240
AM.....	164
bandwidth, system.....	159
clock, characterization.....	212
contribution to frequency fluctuations.....	54
dependence of various types.....	167
differential phase measurements.....	171
flicker.....	158, 211, 226
FM.....	7, 210, 226, 298
frequency.....	114, 178
phase.....	62, 114, 167
FM.....	164, 226
frequency.....	158
improved phase characteristics (crystal oscillators).....	105
non-deterministic.....	159
power.....	159
power law processes.....	211
process.....	159, 220
$\alpha = -1$ .....	160, 212
optimum filters.....	225
random.....	167
shot.....	54, 114, 123, 128
spectrum.....	207
types, frequency dependence.....	167
white.....	115, 167, 226
FM.....	210, 226
frequency.....	115
Non-random deviations.....	153
Non-reciprocity of propagation path.....	271, 310a
North Atlantic Synchronization (Synchron) aircraft flyover.....	294
NP-0532 pulsar time transfer.....	294
evaluation for TFD.....	296
fractional frequency deviations vs sample time.....	295
NPL (National Physical Laboratory), England.....	94
NRC (National Research Council), Canada.....	95, 103
NRLM (National Research Laboratory of Metrology), Japan.....	104
Nuclear	
atoms.....	69
effect, frequency stability (crystal units).....	51
magnetic moments.....	89
spin.....	71, 76
Nucleus	
atom.....	67, 69, 71
lithium.....	89
Null ephemeris table – Loran-C.....	255, 384
Number of users TFD systems serve.....	301

O

Offset, frequency.....	8, 210
Omega navigation system.....	251
basic pattern.....	252
evaluation for TFD.....	253
10-second proposed format.....	253
On-board clock (satellite).....	269, 271, 273
On-line	
clock.....	216
computer processing.....	215
On-site clock visit.....	292
One-sided spectral density.....	179
One-way satellite system.....	270
Operational amplifier.....	169

	Page
Optical pulsars (see Pulsars)	
Optical pumping.....	82, 89-91, 97, 130, 132, 141
Optics	
beam	
alignment.....	124
hybrid.....	108
system.....	116
Optimum	
filter.....	210, 225
HF radio measurement procedures.....	250
Orbit	
predictions.....	273
satellite.....	269
"Orbit" television system (USSR).....	277
Orbital	
angular momentum number.....	73
elements, satellite.....	270
motion, earth.....	5, 6
Organization	
chart	
NBS-Department of Commerce.....	346
NBS-Time and Frequency Division.....	319
USNO-Time Service Division.....	320
functions	
NBS.....	318, 329
USNO.....	319, 347
Oscillators.....	43, 62, 93, 95, 267
active maser.....	79, 128
calibration of remote.....	267
cesium.....	81, 263
design circuit.....	53
environment.....	52, 155
frequency	
fluctuations.....	54
fractional, stability/function of sample time.....	211
stability measurement system.....	173
laser.....	129, 143
precision.....	52
quartz.....	43, 83, 115, 158, 211
crystal (see quartz crystal oscillator)	
crystal controlled.....	52, 62
flicker of phase and DC flicker noise.....	62
frequency-time performance.....	49
future developments.....	55, 62
general purpose.....	52
short term stability.....	54, 62
severe environment.....	52
slave.....	115, 128
temperature compensated.....	52, 60
thermal shot noise.....	54
voltage controlled.....	52, 163
Oven.....	80
collimator.....	121
detector.....	121

## P

"Paper clock".....	227
Particle.....	127-130, 141
beam apparatus.....	141
cesium beam tube.....	143
collisions.....	142
confinement.....	129, 141
detection.....	78, 128
flux of signal.....	128
interrogation.....	127, 141
momentum.....	70
preparation.....	130, 141
pulsed.....	131
storage.....	129, 141, 142
wavelength.....	70

	Page
Passive	
device.....	78
method, particle interrogation.....	129
technique.....	134
television.....	259
Path delay.....	222, 240, 250, 259, 270
contours (satellite).....	277
differential.....	259
propagation.....	240
Pauli exclusion principle.....	74
Period measurement.....	163
Periodicity.....	74
Perturbation, random (clocktime).....	209
Phase	
anomalies.....	244, 310
automatic correction (APC), telephone lines.....	297
difference instability.....	113
bias (cavity).....	121, 123
fluctuations.....	166, 180
frequency domain measure.....	114, 166
phase sideband power, related.....	180
spectral density.....	166
lock loop.....	169
loose.....	169
tight.....	170
noise	
characteristics (crystal oscillators).....	62, 105
flicker.....	62, 114, 167
quadrature.....	162, 167, 171, 180
random walk (time).....	166, 167, 211, 226
records (VLF).....	242
residual error.....	243
shift	
cavity.....	104, 121, 130
diurnal.....	242, 245, 296, 310a
problems.....	104
shifter, adjustable.....	171
sideband power-fluctuations.....	180
stability of the meteor burst trail.....	283
tracking	
LF signals.....	245
VLF signals.....	242
trans-Atlantic comparisons.....	242
values, daily.....	252, 383, 384
Photo cell.....	78, 83
detector.....	91
Photoelectric effect	
Einstein explanation.....	68
theory (Shrödinger and Heisenberg).....	70
Photographic integration, LF time pulse measurements.....	246
Photographic Zenith tube (PZT).....	320
Photon.....	91, 129
recoil effects.....	141, 142
Physical	
basis-atomic frequency standards.....	67
measurements of time.....	81
Physikalisch Technische Bundesanstalt (see PTB)	
Planck's constant.....	68, 70, 88, 142, 144
Planetary motion.....	69
Plate strain, vibrating crystal.....	46, 48, 59
Plates (quartz)	
AT-cut.....	44, 59
FC-cut.....	60
Polar motion.....	6, 284
Portable clocks.....	95, 290
evaluation for TFD.....	292
Position ambiguity (navigation).....	251
Post-detection bandwidth.....	164
Postdoctoral research awards (NBS).....	361
Potassium	
atoms.....	88
emission electrons.....	75

	Page
Power	
grids	
synchronization of interconnected.....	246
U.S. coast to coast interconnected.....	298
law	
frequency and time domain characteristics.....	211
noise processes.....	211
spectral densities.....	156, 165
line (60 Hz) signal-time transfer.....	298
evaluation for TFD.....	299
fractional frequency stability.....	299
noise.....	159
optimum microwave.....	116
shift measurement.....	123
spectral density (crystal units).....	54
Precision	
clock rate or frequency.....	208
clocks, international comparisons.....	294, 295
definition.....	140, 154
frequency	
sources, state-of-the-art.....	62
standards, calibration.....	98, 218
NBS-III.....	113
oscillator.....	43, 52, 62
synchronization, time scale.....	208
Precise Time and Time Interval (see (PTTI))	
Prediction	
exponential.....	213
routine.....	218
long-term performance-HF communications systems.....	251
minimum-squared error of time.....	212
orbit (satellite).....	273
oscillator aging.....	158, 159
theory, clock errors.....	162
time algorithms.....	214
Pressure-temperature shifts (gas cells).....	97
Primary standards.....	78, 79, 127, 214
candidates for.....	133, 146
concepts.....	133
evaluable.....	219, 223
frequency (see Frequency standard, primary)	
frequency and time interval.....	208, 319
future-areas of promise.....	127
inaccuracies in evaluation of rate.....	219
state-of-the-art.....	104, 140, 214
Probability distribution.....	158
Propagation	
characteristics of various RF bands.....	310a
delay	
radio.....	240, 256
path.....	259
theoretical predictions.....	243
factors affecting.....	310a
ionospheric anomalies.....	240
mathematical models.....	240
media.....	240
vagaries.....	252
Properties, deterministic.....	158, 208
PTB (Physikalisch Technische Bundesanstalt).....	104
CS-1 (cesium standard).....	223
PTTI (Precise Time and Time Interval).....	363
meetings.....	321
standards and calibration facilities.....	365, 371
USNO responsibilities.....	363
Publications	
NBS time and frequency.....	183, 383
Special Publication 236.....	319
USNO time and frequency.....	384
Pulsars.....	294
differential fractional frequency deviations.....	295
NP-0532.....	294
time transfer system (optical signals).....	294
evaluation for TFD.....	296

	Page
Pulse	
coded Loran-C format.....	255
LF decay time measurements.....	246
methods, accuracy evaluation of NBS-5.....	123
modulation, time.....	246
repetition rates	
Loran-A navigation systems.....	257
Loran-C navigation systems.....	256
sync (TV).....	259, 262
transfer standard.....	259
time (WWV, WWVH).....	249
VLF methods.....	243
Pulsed	
microwave excitation.....	104
preparation, particle.....	131
Pumping, optical (see Optical pumping)	

## Q

Q values.....	92, 94, 96
cavity.....	173
line.....	107, 121, 129
quartz.....	45, 59
Quadrature	
condition.....	173, 180
phase.....	162, 167, 171
Quantization.....	68
spatial.....	88
Quantum	
electronic frequency standards.....	127, 131, 319
historical development.....	139
mechanics, theory.....	70, 72
numbers.....	70, 73
transition.....	128, 129, 140
Quartz.....	43, 59
crystal.....	43, 59
aging.....	48, 49, 61, 290
ambient temperature changes.....	48
amplitude distribution.....	46
amplitude of vibration.....	50, 53
anharmonic overtone in.....	60
AT-cut plates.....	44, 59
characteristics.....	43
clock.....	218, 290
crystalline body vibration.....	60
crystallographic axes.....	44
dielectric constants.....	45
dissymmetric modes.....	48
drift rates.....	43, 48, 54, 290
drive level (frequency stability).....	50, 61
elastic constants.....	45
electrical equivalent circuit.....	44, 59
enclosures.....	44, 61
energy trapping.....	46-48, 60
FC-cut plate.....	60
first clock.....	290
flexure-type, shear modes.....	47, 49, 59
foamed mounting.....	52
frequency	
deviations.....	50
stability.....	43, 48, 52, 54, 60
temperature drift compensation.....	50, 52
glass units.....	49
imperfections.....	48, 50
lattice distortion.....	46
long-time drift.....	48
metal units.....	49
modes of motion.....	44, 46, 59
nuclear effects on.....	51

	Page
oscillators.....	43, 52, 62, 81, 83, 93, 95, 115, 123, 158, 211
aging.....	49, 61, 158
characteristics.....	43
controlled.....	62
design circuit.....	53
flicker of phase and DC flicker noise.....	62
frequency	
fluctuations.....	54
stability.....	43, 48, 60
future developments.....	55, 62
improved phase noise characteristics.....	62
low frequency types.....	49
output phase noise.....	62
performance, precision.....	49, 62
precision.....	52, 53
severe environment.....	52
short-term stability.....	54
state-of-the-art.....	43, 59, 62
temperature compensated.....	51-53, 60
thermal and shot noise.....	54
TRANSIT (satellite) stability.....	273, 274
voltage-controlled.....	52
plates	
dispersion curves for thickness shear and flexure.....	60
mode shapes.....	60
Q-values.....	45, 59
resonance patterns.....	46, 59
shock and vibration, effects on.....	50-52, 61
short-term	
frequency changes.....	49
stability.....	54, 62
stress distribution.....	46
stress-strain relationship.....	50, 51
synthetic.....	45, 59
units	
acceleration.....	50, 61
high-frequency aging.....	49
power spectral density.....	54
triple, ribbon supported.....	52
vibration, mechanical.....	48, 50, 61
width-shear vibrators.....	48, 49
vibrating	
mounting systems.....	44
plate strain.....	46, 52, 60
impurities.....	50
material.....	45, 59
natural.....	45
noise.....	54
resonators.....	59
strain in vibrating plates.....	60
thermally induced strain (non-aging).....	50
vibration.....	50, 61
vibrators	
acoustic loss.....	46
basic modes.....	44
designations.....	44
distribution of strain.....	48
frequency-time performance.....	49
mounting systems.....	45
quality factor.....	54
resonance pattern.....	46
stress distribution.....	46
surface strain.....	48
temperature/frequency effects.....	48, 52, 53, 60
thermal shock.....	50
width-shear.....	48, 49

## R

Rabi magnetic resonance method.....	88, 94
Radar (Doppler) signal instabilities.....	161
Radiation	
barium oxide.....	131
black-body.....	68, 71

	Page
electromagnetic.....	68, 71
frequency.....	72
iodine absorption, laser.....	131
methane.....	131
optical resonance.....	90
sulfurhexafluoride laser.....	131
<b>Radio</b>	
astronomy stations, worldwide net.....	285
broadcast stations for TFD (map).....	241
characteristics of frequency bands.....	310a
commercial for TFD.....	282
delay path (satellite).....	269
dissemination of time and frequency.....	239
dissemination techniques.....	240
evaluation of methods for TFD.....	244, 246, 251, 282
HF broadcasts.....	247
LF broadcasts.....	245
VLF broadcasts.....	241
frequency bands 4 through 10, characteristics.....	310a
frequency (RF) spectral density.....	156
HF skywave signals.....	251
microwave systems for TFD.....	281
navigation systems for TFD.....	251
propagation	
factors.....	240, 310a
path delay.....	240, 259
Radux navigation system.....	242
<b>Ramsey</b>	
cavity.....	113, 116, 130
fields.....	89, 92
resonance.....	94, 105
separated oscillating fields.....	92
spectrum.....	123
type cavity.....	121
<b>Random</b>	
deviations.....	153
fluctuations.....	166, 207
perturbation of a clock's time.....	209
uncertainty.....	133
walk.....	153, 166
walk FM.....	211, 226
walk of phase (time).....	167, 226
Range-range (navigation system).....	251
<b>Ranging</b>	
Doppler.....	288
navigation.....	252
<b>Rate</b>	
accuracy of AT (NBS) scale.....	219, 220
time correction.....	220
<b>Ratio</b>	
carrier to noise.....	161
charge to mass.....	69
<b>Real-time synchronization</b>	
stabilized TV sync pulses.....	262
transfer in local TV service area.....	264
Received accuracy of broadcast carrier.....	282
Receiver cost for stated accuracy (TFD).....	301
Recoil effect (particle interrogation).....	129, 141, 142
Recursive filter (Flicker noise FM).....	226
Redundancy.....	9
cesium frequency standards (Omega).....	256
<b>Reference</b>	
NBS T/F broadcasts.....	207
stable.....	218
standards, national.....	95, 104, 317
stations (USNO time).....	379
tables	
Loran-C, TOC.....	254, 384
television, TOC.....	263, 384
Refractive index (radio signals).....	269

	Page
Relative	
fractional frequency stability.....	114, 116, 262, 265, 295, 299
time difference AT(NBS)–AT(USNO) time scales.....	262
Relativistic gravitational shifts.....	271
Relativity.....	103
Einstein theory of special.....	71
general theory.....	144
measurements.....	284
tests.....	106
Relaxation time.....	92, 128
RELAY-II (satellite).....	272
Relay transponder, satellite.....	269
Reliability.....	9, 103, 238, 301
Reorganization Plan 3 of 1946 (USNO).....	350
Repeatability, signal arrival time.....	238
Repetitive resynchronizations.....	289
Reporting data, uniform methods of.....	175
Reproducibility, intrinsic.....	154
Reroutes, TV networks.....	261
Residuals.....	208
phase error VLF.....	243
Resistance-phase sensitivity (telephone TFD).....	297
Resonance.....	72, 105, 106
ammonia.....	92
atomic beam magnetic techniques.....	87
cavity.....	129
cesium.....	81, 94, 319
curves.....	89, 90
double, techniques.....	90, 96
frequency.....	319
hydrogen.....	98, 106
linewidth of curve.....	72
lithium nucleus.....	89
microwave.....	4
optical radiation.....	90
pattern (crystal vibrators).....	46
quartz plates (AT-cut).....	59
Rabi magnetic method.....	88, 89
Ramsey curves.....	105, 106
rubidium hyperfine.....	82, 97
Resonator, quartz.....	59
Resynchronization of remote clocks.....	253
Rho-rho navigation technique.....	251
Rotation of the earth.....	7, 317
Routing of TV signals in USA.....	260
Rubidium.....	77
commercial standards.....	97, 108
gas cell.....	81, 89, 97, 131, 133
diagram.....	82
hyperfine resonance.....	81, 97
maser.....	131, 132
oscillator frequencies (TV standards).....	263
transition frequency.....	82
Russell-Saunders coupling.....	74
Rutherford experiment.....	67

## S

Sample averaging of independent estimates of $S_y(f)$ .....	165
Sample size, $M$ .....	165
Sampling time	
interval.....	178
oscillator frequency fluctuations.....	54
SAT (Stepped Atomic Time).....	8
Satellite, orbiting	
elements.....	270
low-altitude.....	269, 271
medium-altitude.....	269, 275
Satellites.....	223, 269



	Page
antenna pointing charts.....	277
ATS-I.....	270, 272
ATS-3.....	272, 277
basic concepts for TFD.....	269
classification.....	269
communications.....	276
delay (path) computer.....	277
DSCS.....	272, 276
earth coverage of.....	270
evaluation for TFD.....	280
GEOS-II.....	272
geostationary.....	223, 302
LES-6.....	272, 276
low altitude orbiting.....	271, 273
medium altitude.....	269, 275
motion variability (path delay changes).....	271
movement.....	271, 277
NASA-ATS.....	276
Navy Navigation Satellite System (NNSS).....	273
on-board clock.....	269, 271, 273
one-way mode.....	270
orbit.....	269
predictions.....	273
RELAY-II.....	272
relay transponder.....	269
selected T/F comparisons (1962-1973).....	272
side tone ranging technique.....	270
stationary.....	302
synchronous (equatorial).....	269, 280
TACSAT.....	272, 276
TELSTAR.....	272
TIMATION.....	272, 275
TRANSIT.....	272, 273
transponder.....	269
two-way mode.....	270
Saturated absorption.....	129, 133, 134
device.....	142
iodine.....	131, 144
methane.....	84, 107, 133, 144
Scales (see Time scales).....	
Schottky barrier diodes.....	168
mixer.....	215
Script $\mathcal{L}$ (f).....	114, 167, 169, 176
sample calculation of.....	180
versus frequency.....	170
Schrödinger's theory.....	70
Second.....	11, 95, 121, 127
atomic.....	140, 319
definition.....	11, 17, 127, 139, 140, 153, 208, 319
ephemeris.....	6
leap.....	9, 34, 220, 318
TAI.....	7, 9
Second-order.....	
Doppler shift.....	105, 115, 121, 123, 141
time scale algorithm.....	216
Secondary standards.....	79
Selective pumping.....	97
Self-stimulation emission masers.....	79
Series limit (energy levels).....	73
Service areas, local TV.....	263, 264
Servo.....	
bandwidth.....	169, 170
loop.....	169
response.....	163
system.....	
frequency lock (NBS-III).....	114
solid state.....	116
VLF tracking system.....	242
time constant.....	116
Setting of remotely located clocks (TV).....	262
Severe environment oscillator.....	52
Sextant.....	317
Shields, magnetic.....	108, 121

	Page
Shift	
cavity phase.....	104, 124
diurnal.....	242, 245, 296, 310a
Doppler.....	80, 115, 130, 271
energy level.....	129
frequency (wall collision).....	142
light.....	97, 132
relativistic gravitational.....	271
wall.....	79, 98, 105, 134
Shock and vibration, quartz units.....	50, 52
Short-term stability.....	49, 54, 62, 267
Shot noise.....	54, 114, 123, 128
SI (International System) of units.....	140, 207, 319, 323
accuracy capability.....	140
base units.....	140
unit of time.....	19, 23, 27, 140, 207
Side-by-side comparisons, atomic frequency standards.....	95, 290
Side-tone ranging technique (satellite).....	270
Sidereal time.....	6
sigma versus tau.....	167, 170
Signal	
frequency (carrier) variable.....	178
particles, flux.....	128
power line (60 Hz).....	223, 298
processing equipment, errors caused by.....	164
source.....	164
Silver atoms.....	87
Simulation, data.....	212
Simultaneity (time).....	4, 153, 208
Single-frequency phase tracking	
LF signals.....	245
VLF signals.....	242
Sinusoidal modulation.....	173
Skill (operator) required for TFD systems.....	302
Skywave	
hops (HF radio transmissions).....	250
signals	
HF radio.....	251
Loran-C.....	256
Slave	
clock.....	271
oscillator.....	115, 128
Sodium atoms.....	87, 91, 96
Solar time	
apparent.....	5
mean.....	5, 6, 325
Spatial	
quantization.....	88, 89
state selection.....	130, 141
Specification of frequency stability terminology.....	165
Spectra, atomic.....	73
Spectral density.....	54, 115, 157, 165
asymmetry.....	128
concepts.....	156
estimation from time domain data.....	164
fluctuations	
fractional frequency.....	166
frequency.....	177
phase.....	166, 177
voltage.....	177
frequency domain measures of stability.....	178
measure of frequency stability.....	165
one-sided; two sided.....	179
power.....	54, 115
radio frequency (RF).....	156
types of.....	179
Spectral emission lines.....	88
Spectroscopy.....	71
Spectrum	
analyzers, analog.....	164
conservation of electromagnetic.....	257, 302
microwave.....	123
Ramsey.....	123
Speed of light (unified standard).....	127, 145

	Page
Spin .....	71, 106
additional energy levels .....	70
electron .....	73, 88
exchange, collisions .....	129, 130
hydrogen, exchange shifts .....	106
nuclear .....	76
Spontaneous emission .....	72, 128
Stability .....	52, 54, 62, 153
atomic standards .....	103, 108, 114, 123
characterization of frequency .....	154
clock ensemble .....	218, 220
color subcarrier frequency (TV) .....	263, 265
Commercial	
cesium standards .....	107
rubidium standards .....	108
definition .....	154
fractional frequency .....	116, 128
conversion to time stability .....	222
TV system long-term .....	267
frequency (see Frequency stability)	
hydrogen maser standards .....	105
laboratory cesium standards .....	106
long-term .....	114
measures	
applications of .....	161
frequency domain .....	157, 178
time domain .....	157, 165
performance of various frequency standards .....	105–108, 113, 121
short-term .....	54, 62, 128, 267
statistical models .....	209
temperature control .....	48, 52, 60
Stabilized	
commercial broadcast stations .....	282
emissions outside allocated frequency assignments .....	312
navigation systems .....	313
television sync pulses .....	262
Stable time scale and reference .....	218
Standards .....	67, 87, 103, 145, 235
atomic beam frequency (also see Atomic standard) .....	67, 93, 96, 127
historical development .....	87, 103
basic .....	127, 145
calibration (local) .....	267
cesium (see Cesium beam standard)	
frequency	
cesium .....	17, 80, 95, 103, 107, 140
hydrogen .....	79, 97, 105
rubidium .....	81, 97, 108
thallium .....	96
frequency and time	
broadcasts .....	240, 241
signal emission – CCIR Recommendation 460 .....	31
signals in allocated bands .....	241, 311
gas cell .....	90, 97, 132
length .....	144
measurement, unified .....	127, 145, 237
national reference .....	104, 317
primary (see Primary standards)	
quantum electronic frequency .....	127, 131
secondary .....	78
“The” .....	145
time .....	17, 145, 207, 237, 394
interval, frequency .....	144
scale .....	207, 214, 223
unified (frequency, length, time) .....	127, 145, 237
Standard time	
adoption and observance .....	394
advancement, annual .....	399
emergency daylight saving time .....	408
legal definition .....	325
Standard time and frequency	
basic .....	319
emissions .....	31, 240, 241, 311
international organizations involved in .....	323
radio assignments (international) .....	241
responsibilities in the USA .....	317

	Page
Standard time zones USA (map).....	326
boundaries.....	325, 398
relocation – Michigan (1973).....	406
world.....	12
State (energy)	
selection.....	78, 80
separator, electrostatic.....	92
spatial.....	130
State-of-the-art	
laboratory cesium beam.....	104, 113, 121
primary standards.....	214
Stationarity.....	155
Stations	
latitude.....	323
location of broadcasting (for TFD).....	241
master.....	254
NBA, NSS (USNO).....	243
radio astronomy net.....	285
USNO time reference.....	379
WWV, WWVH (NBS).....	247
WWVB.....	245
Statistical	
analysis, T/F data.....	153, 207
models	
frequency stability.....	155, 209
time dispersion.....	210
smoothing, VLF data.....	243
Step, frequency.....	220
Stepped Atomic Time (see SAT)	
Stern-Gerlach experiment.....	88
Stern molecular beam technique.....	87
Storage	
beam.....	79, 131, 135, 142
tube.....	132
box principle.....	92
bulbs.....	79
deformable.....	106
hydrogen.....	79, 97
principle, particles.....	141, 142
technique – interaction time.....	91
Storage of ions.....	143
helium.....	131
mercury.....	131
principle.....	133
Strain (quartz crystal).....	48, 50
surface (vibrators).....	48
thermally induced.....	50
vibrating plate.....	60
Stress	
distribution, vibrating quartz.....	46
vibration and acceleration (quartz).....	50, 61
Structure, C-field.....	108
Study Group 7 (CCIR).....	324
Subcarrier (TV color).....	263
Sub-radar reflection point (MBTS).....	287
Sulfurhexafluoride laser radiation.....	131
Sun-earth-moon relationships.....	5, 319, 357
Sundial.....	5
Survey, accurate frequency measurements.....	144
Sync pulses (TV).....	259, 262
transfer standard.....	259
SYNCHRON (North Atlantic Synchronization) aircraft flyover...	294
Synchronization.....	4, 238
ACAS ground stations.....	289
accuracy and precision of.....	208
aircraft flyover.....	293
clock.....	153, 238, 256
initial.....	243, 262
remote site.....	259, 277, 285, 290
maintenance of time.....	292
day to day (60-Hz system).....	298
definition.....	4, 292
global time.....	242, 290, 293

	Page
interconnected power grids.....	246
intercontinental of precise clocks.....	285, 293
Loran-C navigation system.....	256
system.....	11
worldwide-atomic clocks.....	242, 290
Synchronous	
satellite.....	269, 302
altitude (equatorial).....	269
detection.....	116
Synthesis, infrared frequency.....	142
Synthetic quartz.....	45
System	
AT (NBS) rate measuring.....	215
clock ensemble.....	215
coherent communication.....	237
coverage of a T/F.....	238, 300
fundamental constants and basic standards.....	144
navigation for TFD.....	251
noise bandwidth.....	159
operational for measurement frequency.....	168, 171
single oscillator measuring.....	173
stability descriptions at	
HF region.....	168
microwave region.....	171
Systematic variations and trends (frequency stability).....	158
Système International d'Unites (International System of Units – see SI)	

## T

### TABLES

Accuracy budget for NBS-5 (1973 preliminary).....	124
Accuracy capability of NBS-III (1969).....	115
Bias Functions $B_1$ and $B_2$ .....	192-204
Characteristics:	
frequency stabilized navigation systems useful for time/ frequency comparisons.....	313
Loran-C stations.....	254, 313
radio frequency bands 4 through 10.....	310a
stabilized frequency and time signal emissions outside allocated frequency assignments.....	312
standard frequency and time signals in allocated bands.....	311
Data on different concepts for primary frequency standards.....	133
Designation of "quartz vibrators".....	44
Frequency dependence of various noise types.....	167
Frequency offsets of UTC from 1960 to 1972.....	8
Organization chart:	
NBS – Department of Commerce.....	346
NBS Time and Frequency Division.....	319
USNO Time Service Division.....	320
Promising candidates for primary frequency standards.....	146
Selected time/frequency comparisons via satellites (1962– 1973).....	272, 276
Stability measure conversion chart (frequency domain-time domain).....	166
Standard Time and Frequency radio assignments (WARC).....	241
Survey of accurate frequency measurements.....	144
TACSAT (satellite).....	272
TAI (International Atomic Time).....	7, 19, 22, 27, 207, 321
accuracy.....	223
construction.....	10, 223, 321
current determination.....	39
fractional frequency.....	223, 224
improvement.....	39
rate.....	223
resolutions.....	27
scale.....	10, 321, 324
adoption.....	223
annual frequency drift.....	223
Tau ( $\tau$ ) parameter (ACAS).....	288
Techniques	
active line TV for TFD.....	265

	Page
atomic beam, magnetic resonance.....	87
beat-frequency.....	162
broken-beam.....	92
buffer gas.....	82, 91
clock modeling.....	208
clock synchronization	
Loran-C.....	256
system.....	238
confinement.....	129, 141
constructing and maintaining atomic time scales.....	207
dissemination (see T/F dissemination techniques)	
diversity (radio reception).....	247
double-resonance.....	90, 96
frequency and time domain.....	168
frequency stability measurements	
HF region.....	168
microwave.....	171
X-band.....	171, 174
Frisch-Segre atomic beam.....	88
heterodyne.....	162
maser.....	92
measurement for frequency stability.....	162
multiple frequency, VLF.....	243
optical	
detection.....	91, 96
pumping.....	82, 89-91, 97
radio T/F dissemination.....	240, 284
satellite for TFD.....	269
side-tone ranging (satellite).....	270
Stern molecular beam.....	87
television for TFD.....	259
trilateration.....	277
Telephone lines.....	296
dedicated.....	297
evaluation for TFD.....	297
resistance, phase change.....	296
underground.....	297
Telephone time signals (WWV).....	298
Television.....	259
active line NBS TV system.....	265
frame repetition rate.....	262
local service area.....	263, 264
microwave relay system (USA).....	260
network reroutes.....	261
"Orbit" system (USSR).....	277
passive for TF comparisons.....	259
real time synchronization via stabilized TV sync pulses.....	262
routing of signals.....	260
sync pulses.....	259, 262
sync pulse "transfer standard".....	259
system long-term stability.....	267
TD-2 microwave system.....	260
TFD techniques.....	259
active line injection of T/F information into TV format.....	265
NBS TV system.....	266
color subcarrier.....	263
calibration system.....	264
frequencies.....	263
stability, stabilization.....	263
evaluation.....	264, 265, 267
line-10 (passive technique)	
differential measurements.....	260
fractional frequency stability.....	262
transfer standard.....	260
USNO, line-10 (real time) measurement system.....	262
vertical blanking interval format.....	261
TELSTAR (satellite).....	272
Temperature.....	48, 52, 60
ambient changes (crystal).....	48
compensated quartz oscillator.....	52, 60
compensation advantages/methods.....	48, 52, 60

	Page
frequency effects (quartz crystals).....	48
gas cell.....	97
maser.....	106
Temps Atomique International (see TAI)	
Terminology	
specification of frequency stability.....	165
time scale.....	208
TFD (Time and Frequency Dissemination) (see Dissemination, T/F techniques)	
TF-ACAS (see ACAS)	
Thallium atom beam devices.....	96
beam tube.....	131
Theoretical predictions of propagation delay.....	243
Thermal	
equilibrium.....	130
induced strains.....	50
shock, crystal.....	50
shot noise.....	54
Tidal oscillations.....	284
Tight phase-lock loop.....	170
TIMATION II, III (satellites).....	275
Time.....	4-11, 81, 145, 153, 208, 235
accuracy.....	153
requirements.....	299
Act, Uniform (1966).....	325, 391
algorithms prediction.....	214
announcements (radio).....	248
apparent solar.....	5
aspects.....	153
astronomical.....	5, 13, 95
atomic.....	7, 95
NBS.....	207, 214, 320
TAI.....	7, 27, 223, 257, 321
USNO.....	320, 322
basic concepts.....	4, 10, 208
bibliography.....	14, 230
closure (portable clock).....	291
coarse check.....	277
code.....	253
generator.....	266
IRIG-H (modified).....	248
WWV, WWVH (100 Hz).....	248
WWVB.....	245
comparisons.....	250
constant of phase-lock loop.....	169
coordinated Universal (UTC).....	8
frequency offsets (1960 to 1972).....	8
correction rate.....	220
definition (also see Definitions, time).....	5, 208
delay.....	237
difference.....	215, 218
between clocks.....	219
dispersion.....	226
clock ensemble.....	219, 220
frequency (VLF).....	244
statistical models for.....	210
dissemination (also see Dissemination, T/F techniques).....	319, 361
capabilities of techniques.....	300
digital.....	266
overview of principles and techniques.....	235
time scale UTC(NBS).....	221, 222
domain	
characteristics of various power laws.....	170, 211
computing, counter measurements.....	174
data, spectral density estimation.....	164
frequency stability.....	166
measurements.....	170
translation-frequency domain.....	159, 166, 178
duration.....	4
ensemble, calculation of.....	216
ephemeris (ET).....	6, 95

	Page
equation of.....	6
errors in AT(NBS) scale.....	219
frequency (also see Time and frequency)	
length, unified standard.....	127, 145
metrology.....	140, 145
performance, precision quartz oscillators.....	52-54
global synchronization.....	285, 290, 294
Greenwich Mean Time (see GMT)	
interrogation.....	129
interval.....	4, 11, 95, 139, 153, 208, 237, 319
astronomical.....	95
atomic unit.....	95
sampling.....	178
standard.....	139
mean solar.....	5, 6, 325
mean-square error.....	210
measurements.....	3
envelope.....	252
monotonic function of.....	163
Naval signals (radio).....	321
NBS broadcasts.....	319, 383
ordered format.....	288
physical measurement of.....	81
prediction	
algorithms.....	214, 215
minimum squared error.....	212
pulse	
broadcasts from WWV, WWVH.....	249
modulation.....	246
random walk of phase.....	226
reference stations (USNO).....	292, 379
relaxation.....	91, 128
sampling.....	178
oscillator frequency fluctuations.....	54
scales (see Time scales)	
SI, unit.....	27, 203, 139, 208
sidereal.....	6
signal repeatability.....	238
signals (allocated bands).....	311
simultaneity.....	4
stability, conversion from fractional frequency stability.....	222
standard.....	17, 145, 207, 237, 394
basic.....	319
broadcasts in allocated bands.....	311
USA.....	317
system, nation unified.....	382
ticks.....	248
transfer.....	239, 276, 294, 298
mode.....	222
optical pulsar signals.....	294
power line (60 Hz) signal technique.....	298
precise.....	285
system description.....	239
television techniques.....	259
VLF radio signals.....	243
unit of.....	23, 153
unified standard for.....	127, 145
Time and frequency (also see Frequency; time)	
abbreviations.....	458
accuracy levels of service (satellite TFD).....	277
activities	
NBS (Time and Frequency Division).....	318, 361
USNO (Time Service Division).....	320, 357
classification of users.....	299
dissemination (also see Dissemination T/F techniques)	
overview of principles and techniques.....	233, 236, 237
Division (NBS).....	318, 361
DOD.....	365
location of broadcasting stations used for T/F dissemination.....	241
metrology.....	127, 140, 145, 148, 237



	Page
NBS activities.....	318, 359
NBS/USNO responsibilities.....	321, 322, 377
publications	
NBS.....	183, 383
USNO.....	384
radio dissemination.....	240
standard radio broadcasts.....	241, 311
standards in the USA.....	207, 317
system coverage.....	238, 300
technology.....	302
transfer, basic considerations.....	235
user and system evaluation.....	300
user needs.....	299
Time domain.....	155, 157, 159, 170, 178, 211
conversion to frequency domain.....	159
frequency stability.....	166
measurement.....	170
computing counter.....	174
spectral density estimation.....	164
stability measure.....	165
translations among measures.....	160
Time of Coincidence (TOC)	
Loran-C reference tables.....	255, 384
TV reference tables.....	263, 384
Time-ordered format.....	288
Time Reference Stations (USNO).....	292, 379
Time scale.....	3, 4, 8, 11, 23, 207, 223, 317, 322
A. 1 (USNO).....	320
algorithms.....	214, 215
first order.....	216
mini-computer program.....	227
second order.....	216
astronomical.....	5, 11
AT (NBS).....	205, 214
block diagram.....	214
generation, stability, accuracy and accessibility.....	205
long-term accumulated time, errors of 6 selected cesium clocks.....	219
overview.....	207
relative fractional frequencies of 5 selected clocks.....	219
system.....	214, 322
AT (NBS)–AT(USNO).....	262, 321
atomic.....	4, 205, 320
algorithms.....	215
construction and maintenance.....	207
NBS.....	205, 320
TAI (see TAI)	
USNO (A. 1).....	320
automation system.....	219
bibliography.....	14, 230
celestial navigation.....	11
comparisons.....	9, 291, 294, 321
compromise.....	13, 318
coordinate, UTC (NBS).....	207, 220
coordination.....	322
agreement, NBS and USNO.....	220, 382
clock time scales.....	220, 381
frequency dispersion in the memory.....	220
navigators.....	318
relative time difference AT (NBS)–AT (USNO).....	262
simultaneity.....	4
stable.....	219
synchronization.....	4
systems.....	11
TAI (also see TAI).....	10, 27, 220, 223, 321, 324
unit of (BIH).....	23, 321
USA.....	322
USNO and NBS UTC, coordination.....	292, 322, 381, 382
USNO clock.....	272, 320

	Page
UTC.....	8, 220
UTC (NBS).....	220, 221, 261, 320
Time Service Division (TSD-USNO).....	320, 363
Time, Universal.....	6, 7, 32
UT0.....	6
UT1.....	6
UT2.....	6
UTC(BIH).....	10, 23, 220
Time zones	
USA standard.....	325, 326
world map.....	12
Timekeeping.....	3
accuracy progress (1000 to 1973 AD).....	3
accuracy via Loran-C.....	256
Total	
angular momentum.....	76
energy, E.....	69
TRANET tracking network.....	275
Trans Atlantic phase comparisons.....	242, 294
Transfer	
clock.....	271
standard.....	239, 259
Transform, Fourier.....	158, 210
Transformation, frequency.....	128, 132
TRANSIT satellite.....	272-274
crystal oscillator stability.....	273, 274
Transitions (atomic).....	69, 71, 72, 88, 129
ammonia inversion.....	92
cesium.....	81, 95, 122
clock.....	128
coupling.....	130
dipole, magnetic.....	98, 130
energy levels.....	67-70, 72, 88
frequency.....	77, 130, 141
high frequency.....	130, 134
hydrogen.....	79, 98, 106
hyperfine.....	98, 107, 127, 130
iodine.....	141
linewidth.....	78
majorana.....	130
probability.....	72
quantum.....	128, 129, 140
rubidium.....	81, 97
Translations	
frequency stability measures.....	159
time domain measures.....	160
Transmissivity optical.....	132
Transmission phase data-coax cable.....	297
Transmissions (radio) descriptions RF bands 4 through 10.....	310a
Transponder (satellite).....	270
Traveling beam tube.....	131
Treaty of the Meter (Standards).....	324, 385
Trend, UT - ET.....	7
Trilateration.....	223, 277, 289
Triple ribbon supported HF crystal unit.....	52
Tube	
cesium beam (atomic).....	121, 127, 131, 143
hydrogen storage beam.....	131, 132
Photographic Zenith (PZT).....	320
thallium beam.....	131
TV (see Television)	
TV-time (NBS active TFD system).....	266
Two-way mode	
aircraft flyover.....	294
satellite.....	271
Types of spectral densities.....	179

## U

Uncertainties	
bias.....	124, 128, 129
random.....	133

	Page
UNESCO (United Nations Educational, Scientific and Cultural Organization).....	324
Unified standard (frequency, length, time).....	127, 145, 237
Unified time	
adoption and observation (time zones).....	394
nation gets system (accurate).....	382
Uniform methods of reporting T/F data.....	175
Uniform Time Act of 1966.....	325, 391
Units	
frequency-Hertz.....	10, 70, 140
measurement, SI.....	17, 27, 139, 208
time interval	
astronomical.....	95
atomic.....	95, 139
time/time scale (BIH).....	23, 25, 153
Universal Time (UT) (see Time, Universal)	
URSI (International Science Radio Union).....	324
USA	
standard time zones.....	325, 326
standards of time and frequency.....	317
time scales.....	322
Users, T/F dissemination	
cost to.....	222, 238, 301
evaluation of selected techniques.....	300
number that can be served.....	301
U.S. Naval Observatory (see USNO)	
USNO (U.S. Naval Observatory).....	317, 319, 349, 351
A, 1 time scale.....	320
authorizing documents.....	347
clock time scale.....	320
functions and missions.....	319, 322, 357
line-10 (real time) TV measurements.....	262
Naval time signals (radio).....	321
NBS coordination.....	220, 292, 321, 381, 382
organization chart (TSD).....	320
publications, time and frequency.....	384
PTTI responsibilities.....	363
Time Reference Stations.....	379
Time Service Division (TSD).....	320
UTC time scale.....	292, 321
UT (see Time, Universal)	
UTC (BIH).....	10, 220, 322
new system.....	8
UTC (Coordinated Universal Time).....	10, 32, 220, 318
frequency offsets.....	8
UTC (NBS).....	261, 321, 382
accessibility.....	221, 222, 245, 248
coordinated time scales.....	220
time scale.....	207
UTC(USNO).....	261, 321, 382
coordination with NBS.....	220, 321, 381, 382
time scale.....	207, 220, 261

## V

Variability in path delay, satellite motion.....	271
Variance, Allan (see Allan variance)	
Variations, systematic.....	158
Velocities, atoms.....	72, 122
Maxwellian distribution.....	72
Veractor tuning.....	169
Vertical blanking interval-TV format.....	261, 267
Very Long Baseline Interferometry (see VLBI)	
VHF radio signals	
signals reflected from meteor trails.....	283
transponders (satellite).....	270

	Page
Vibration (quartz crystals).....	50, 61
amplitude.....	50, 53
mechanical.....	50, 61
shock.....	52
Vibrators (see Quartz crystal vibrators)	
Vibratory plates (synthetic quartz).....	45
VLBI (Very Long Baseline Interferometry).....	284
evaluation for TFD.....	285
geometry of receiving sites.....	284
VLF radio signals.....	241
corrections to broadcasts.....	243, 384
evaluation for TFD.....	244
Frequency Shift Keying (FSK) of carriers.....	244
multiple-frequency techniques.....	243
pulse methods.....	243
single frequency comparison.....	242
statistical smoothing of data.....	243
time transfer.....	243
use in TFD.....	244
Voltage	
controlled oscillator.....	52, 53
frequency converter.....	170
<b>W</b>	
Walk-in service, T/F comparisons (ACAS).....	289
Wall	
coatings.....	92, 98
collisions.....	129, 142
shift.....	98, 105
bias.....	134
error.....	106
Wave	
analyzer.....	169
electromagnetic (EM).....	71
function.....	70
theory.....	71
Weighting	
factors.....	218
filter, exponential.....	212
White noise.....	166, 167, 211, 225
FM-random walk of phase (time).....	167, 226
frequency (cesium beam standards).....	115
Width-shear vibrators, quartz crystal units.....	48, 49
World Administrative Radio Council (WARC).....	240
Worldwide	
net of radio astronomy stations.....	285
synchronization of atomic clocks.....	285, 290, 294
WWV/WWVH (NBS standard HF-T/F stations).....	247
accuracy of WWV transmissions, 1923-1973.....	247
broadcast format.....	249
telephone signals (WWV).....	297
time	
code.....	248
pulse broadcast characteristics.....	249
WWVB (NBS frequency stabilized LF station).....	245
time code.....	246
<b>X</b>	
X-band frequency	
measurements.....	173
source.....	173
techniques for frequency stability measurements.....	174
<b>Y</b>	
Year, leap.....	8
Yearly UTC adjustments.....	8

## Z

Page

<b>Zeeman</b>	
spectral lines .....	88
splitting .....	90
<b>Zero-beat method of comparing frequencies</b> .....	250
<b>Zero-coefficient (crystals)</b> .....	45
<b>Zenith Photographic Tube (PZT)</b> .....	520

## TIME AND FREQUENCY ABBREVIATIONS LISTING

ACAS	Aircraft Collision Avoidance System	IAU	International Astronomical Union
AEP	American Electric Power Company	IBS	Institute for Basic Standards (NBS)
APC	Automatic Phase Corrector	ICAO	International Civil Aviation Organization
AT	Atomic Time	ICSU	International Council of Scientific Unions
ATS-1 & -3	Applications Technology Satellites 1 & 3 (NASA)	IFRB	International Frequency Registration Board
BIH	Bureau International de l'Heure <sup>1</sup> (International Bureau of Time)	IMCO	Intergovernment Maritime Consultative Organization
BIPM	Bureau International des Poids et Mesures (International Bureau of Weights and Measures)	IPMS	International Polar Motion Service (formerly International Latitude Service, ILS)
CCDS	Comité Consultatif pour la Définition de la Seconde (Consultative Committee for the Definition of the Second)	IRIG	Inter-Range Instrumentation Group (USA)
CCDM	Comité Consultatif pour la Définition de la Metre (Consultative Committee for the Definition of the Meter)	ITU	International Telecommunications Union
CCIR	Comité Consultatif International des Radiocommunications (International Radio Consultative Committee)	IUGG	International Union of Geodesy and Geophysics
CGPM	Conférence Générale des Poids et Mesures (General Conference of Weights and Measures)	IUPAP	International Union of Pure and Applied Physics
CIPM	Comité International des Poids et Mesures (International Committee of Weights and Measures)	IWP	Interim Working Party
DOC	Department of Commerce (USA)	LES-6	Lincoln Experimental Satellite No. 6
DOD	Department of Defense (USA)	LF	Low Frequency
DSCS	Defense Satellite Communication System	LSRH	Laboratoire Suisse de Recherches Hologères (Swiss Laboratory of Clock Research)
DUT 1	The approximate value of the difference UT1 minus UTC as transmitted (may be regarded as a correction to be added to UTC to obtain an approximation of UT1 $DUT1 \approx UT1 - UTC$ )	MBTS	Moon Bounce Time Synchronization
EM	Electromagnetic	MF	Medium Frequency
ET	Ephemeris Time	MTBF	Mean Time Between Failure
FAGS	Federation of Astronomical and Geophysical Services	NASA	National Aeronautics and Space Administration (USA)
FM	Frequency Modulation	NBS	National Bureau of Standards (USA)
FSK	Frequency Shift Keying	NNSS	Navy Navigation Satellite System
GEOS	Geodetic Earth Orbiting Satellite (NASA)	NOAA	National Oceanographic and Atmospheric Administration (DOC)
GOES	Geostationary Operational Environmental Satellite (DOC/NOAA)	NPL	National Physical Laboratory (England)
GMAT	Greenwich Mean Astronomical Time	NRC	National Research Council (Canada)
GMT	Greenwich Mean Time	NRL	Naval Research Laboratory (USA)
GRI	Group Repetition Interval	NRLM	National Research Laboratory of Metrology (Japan)
HF	High Frequency	PCM	Pulse Code Modulation
Hz	Hertz (cycles per second)	PTB	Physikalisch-Technische Bundesanstalt (Physical Technical Federal Laboratory - Germany)
		PTTI	Precise Time and Time Interval
		PZT	Photographic Zenith Time
		RELAY II	Satellite
		RF	Radio Frequency
		RGO	Royal Greenwich Observatory (England)

<sup>1</sup>The original language is given for the abbreviation followed by the English translation.

SAT	Stepped Atomic Time	TRANET	Tracking Network
SHF	Super High Frequency	TRANSIT	NNSS Satellite (US Navy)
SI	Système International d'Unites (International System of Units)—officially abbreviated SI—is a modernized version of the metric system. It was established by international agreement (CGPM) to provide a logical and interconnected framework for all practical measurements in science, industry, and commerce. SI is built upon a foundation of base units and their definitions, from which all other units are derived	TV	Television
		UHF	Ultra High Frequency
		UNDP	United Nations Development Program
		UNESCO	United Nations Educational, Scientific, and Cultural Organization
		URSI	Union Radioscientifique Internationale (International Science Radio Union)
		USNO	United States Naval Observatory (USA)
		UT	Universal Time.
TACSAT	Tactical Communication Satellite (DOD)	UT0	Universal Time—An apparent solar time corrected for the earth's orbital and inclination effects
TAI	Temps Atomique International (International Atomic Time) (It is the coordinate of time reference established by the BIH on the basis of data from atomic clocks functioning in several establishments conforming to the definition of the second, the unit time of the SI.)	UT1	Universal Time 1—UT0 corrected for polar motion based on astronomical measurements from worldwide observatories
TD-2	USA Microwave Network System (TV)	UT2	Universal Time 2—UT1 corrected for periodic seasonal fluctuations
TELSTAR	Satellite (first reported clock comparison—see table 10.9)	UTC	Universal Time Coordinated (a time scale coordinated by the BIH relating to TAI by time differences of an integral number of seconds and tracking UT1 by leap seconds)
T/F	Time and Frequency	VHF	Very High Frequency
TF/CAS	Time and Frequency—Aircraft Collision Avoidance System	VLBI	Very Long Baseline Interferometry.
TFD	Time and Frequency Dissemination	VLF	Very Low Frequency
TIMATION	Time Navigation Satellite (US Navy)		
TOC	Time of Coincidence (Loran-C and TV Tables)	WARC	World Administrative Radio Conference