

THE ATOMIC CLOCK

An Atomic Standard of Frequency and Time

A basically new, primary standard of frequency and time, invariant with age, has been developed at the National Bureau of Standards; an atomic clock based on a constant natural frequency associated with the vibration of the atoms in the ammonia molecule. Based on a principle developed by Dr. Harold Lyons of the Bureau's microwave research laboratory, the new clock promises to surpass by one or two orders of magnitude the accuracy of the present primary standard, the rotating earth. Dr. Lyons was assisted in the design and construction of the clock by B. F. Husten, E. D. Heberling, and other members of his staff.

This is the first atomic clock ever built and is controlled by a constant frequency derived from a microwave absorption line of ammonia gas, providing a time constancy of one part in ten million. Theoretical considerations indicate a potential accuracy of one part in a billion or even ten billion, depending on the type of atomic system and spectrum line used.

The present crowding of the radio frequency spectrum has imposed severe limitations, both nationally and internationally, on the expanding use of radio for industry and communications. The atomic clock may be expected to benefit greatly the communications industries and the military services, for it will, in effect, provide additional room in the radio frequency range for more communication stations of all types. The present "radio space" allows for a drifting of each station's frequency, so that a broad "radio space" is required if interference with other stations is to be avoided. The maximum utilization of available space in the radio spectrum depends on the accuracy with which

the frequency of an individual station can be controlled, especially at the higher frequencies where quartz crystals cannot be used as frequency controlling elements. These frequencies, used by radar, television relays, and microwave equipment in general, could be controlled by atomic elements. Such control would also make possible the permanent establishment of radio channels on such an exact basis that tuning could be made as automatic as the dialing of a telephone number.

The improvements in frequency and time measurement offered by the atomic clock are also of fundamental importance in many fields of science. An absolute time standard will be of special importance in astronomy, where present time standards leave much to be desired. The atomic clock and the method represent important tools of research and development in every technical field where precise measurements of time and frequency are crucial--for example, in long-range radio navigation systems, in the upper range of the microwave region where atomic systems can serve as electronic components, and in basic research in microwave spectroscopy and molecular structure.

The present time and frequency standards are based on astronomical determinations of the period of rotation of the earth. However, the earth is very gradually slowing down in response to the forces of tidal friction in shallow seas. In addition, there are irregular variations--some of them rather sudden--in the period of rotation, the reasons for which are unknown. These two causes are responsible for changes in mean solar time and therefore in the frequency of any periodic or vibrating systems measured in terms of such time standards.

In recent years, vibrations of atoms in molecules--or what are more specifically termed spectrum lines originating in transitions between energy

levels of these atomic systems--have been found in the microwave region of the radio spectrum. It has been possible to make very precise measurements of these lines by radio methods using all-electronic equipment of unprecedented sensitivity and resolution. When it became evident that such spectrum lines might eventually provide new primary frequency standards, scientists at the National Bureau of Standards began seeking a means of utilizing one of these lines to control an oscillator which in turn could be used to drive a clock. Because the resulting equipment, the atomic clock, is controlled by the invariable molecular system of ammonia gas, it is independent of astronomical determinations of time.

The National Bureau of Standards atomic clock consists essentially of a crystal oscillator, a frequency multiplier, a frequency discriminator, and a frequency divider, all housed in two vertical-type cabinet racks, on the top of which are mounted a special 50-cycle clock and a waveguide absorption cell. Ammonia gas under a pressure of 10 or 15 microns is maintained in this cell, a rectangular  $1/2 \times 1/4$ -inch copper tube wound in a compact 30-foot spiral about the clock.

The new development uses an absorption frequency of ammonia to hold a microwave signal fixed. If the microwave signal output of a generator differs in frequency from the ammonia absorption line, then the control circuits generate an "error signal" which brings the microwave signal back to the frequency of the spectrum line. The oscillator generating the microwave signal is thus controlled, and the setting of the clock which it drives can be compared with an astronomical clock.

The microwave signal is initiated by a 100-kilocycle quartz-crystal oscillator or any other oscillator which, for purposes of convenience and accuracy, is designed for a high degree of stability. By means of vacuum-tube

circuits and silicon-crystal diodes, this frequency is multiplied to provide output signals throughout the microwave range. These signals are compared with the frequency of a microwave spectrum line, in this case of ammonia gas, by suitable control circuits, often called frequency discriminator or "servo" circuits. If the quartz-crystal oscillator drifts after the microwave signal at the upper end of the multiplier chain has been exactly tuned to the frequency of the spectrum line, the discriminator circuit generates an output signal which, through the proper control circuits, can be applied to the oscillator at the bottom of the multiplier chain to bring it back to the proper frequency. By means of a frequency divider, the 100 kilocycles may be reduced to any desired frequency for driving a clock; e.g. one thousand cycles or 50 cycles.

#### Principles and Operation<sup>1/</sup>

Frequency-discriminator or servo-mechanism control circuits for atomic clocks might be developed in many different forms. The electronic control circuit in the present atomic clock is one successful form of several being developed by the National Bureau of Standards. It is now being refined to give even greater time-keeping accuracy.

The fundamental frequency signal generated by the 100-kilocycle oscillator is first multiplied up to 270 megacycles per second (abbreviated Mc) by a frequency-multiplying chain using standard low-frequency tubes. In the next step, the multiplying chain is continued up to 2970 Mc by means of a frequency-multiplying klystron, which is also modulated by an FM oscillator generating a signal at  $13.8 \pm 0.12$  Mc. This makes the frequency-modulated output of the klystron  $2983.8 \pm 0.12$  Mc. After further amplification, the frequency-modulated signal is multiplied in a silicon crystal rectifier to

23,870.4  $\pm$  0.96 Mc, and fed to the ammonia absorption cell. As the frequency of this modulated control signal sweeps across the absorption line frequency of the ammonia vapor, the signal reaching the silicon crystal detector at the end of the absorption cell dips because of the absorption, thus giving a negative output pulse.<sup>2/</sup>

A second pulse is generated when the output of the frequency-modulated oscillator at 13.8  $\pm$  0.12 Mc is fed to a mixer (or radio receiver) into which is also fed a 12.5-Mc signal from the quartz-crystal multiplying chain. When the signal sweeps across the proper frequency to be tuned in (12.5 Mc plus the 1.39 Mc intermediate frequency of the receiver, or 13.89 Mc), an output pulse is generated. The time interval between the two pulses--that from the absorption cell, caused by the absorption line, and that from the receiver or mixer--is a measure of the degree to which the frequency-multiplying chain is tuned to the absorption line. The two pulses can therefore be made to control a discriminator circuit which will give zero output when the time interval is right (that is, when the circuit is tuned to the absorption line) and will generate a control signal when the time interval is wrong. If the quartz-crystal oscillator drifts in frequency to higher values, the time interval between the two pulses increases; for frequencies which are too low, the interval decreases. The control signals thus generated are fed to a reactance tube, which then forces the quartz-crystal circuit to oscillate at the correct frequency to tune to the absorption line. The quartz-crystal oscillator is thus locked to the ammonia line. Frequency dividers then divide the precise 100-kilocycle signal down to 50 cycles to drive an ordinary synchronous motor clock, and also down to 1000 cycles to drive a special synchronous-motor clock, which is designed for exact adjustment and comparison with astronomical time to within

5/1000 of a second.

Control of the quartz-crystal circuit depends on the relative duration of the positive and negative portions of a square-wave signal generated by the discriminator. In the discriminator, the two pulses between which the time interval is to be measured turn a trigger circuit or square-wave generator on and off. When the time interval is correct, the on-off cycle generates no output signal from the positive and negative peak detectors driven by the square-wave signal. The detectors or rectifiers draw current on the positive and negative peaks of the square-wave, but when the positive and negative portions of the square wave are of equal duration, they balance and give no direct current output. However, if the time interval between the two input driving pulses gets longer or shorter, the relative duration of the positive and negative parts of the square-wave changes so that a resultant direct-current output is generated. This output is positive or negative, depending on the change in the time interval. Thus, no control voltage is generated when the quartz-crystal oscillator is on the proper frequency to agree, through the frequency-multiplying chain, with the ammonia line; but a positive or negative control voltage is produced for correcting the oscillator circuit when it drifts one way or the other from its proper value.

One great advantage of this particular clock circuit lies in the inherent short-time stability of the quartz-crystal oscillator, which makes it unnecessary for the discriminator circuits to apply correcting control signals to the oscillator at a very rapid rate. The crystal and multiplier circuits bridge the gap between the frequency of the clock and that of the absorption line.

Recording equipment and a frequency meter are used in checking the accuracy of the clock. For this purpose, the frequency of the clock's crystal

oscillator is compared to the frequency of the Bureau's primary frequency standards, a group of precision, 100-kilocycle quartz-crystal oscillators calibrated in terms of the U. S. Naval Observatory time signals. These oscillators maintain constant frequency with respect to each other to an accuracy of one part in a billion for intervals up to 10 hours and better than one part in 100 million per day. They can therefore be used to measure the constancy of the atomic clock to this accuracy. This is done by beating the signals from the two sources together at a frequency of 12.5 Mc to obtain greater measurement sensitivity. A change of one cycle per second in the frequency of the beat note, as recorded on the frequency meter or on an automatic recorder, indicates a frequency variation of one part in 12.5 million. In recent tests the clock maintained a constancy of one part in ten million for several hours. These tests show that the clock will lock accurately to the armonia line even when a perturbing signal is applied to the reactance tube in the attempt to force the clock to change its rate.

#### Ultimate Accuracy

The ultimate accuracy of an atomic clock depends on many factors, of which the most important are those governing the width of the spectrum line. Spectrum lines are not infinitely narrow but have a finite width covering a considerable frequency range, since atoms or molecules do not emit or absorb radiation at only one frequency but rather over a narrow band of frequencies. The ratio of a line frequency to its width at the half-power points is called the Q of the line, in analogy to the Q (quality) factor of resonant circuits used in standard radio technique. The Q is a measure of the sharpness of the line and therefore determines its usefulness as an accurate frequency and time standard.

In the case of armonia, the natural line width determined by the uncertainty principle of quantum mechanics gives a Q of about  $10^{18}$  (a billion billion). If a

*time*

line width were determined only by the natural life ~~line~~ of an excited state in the ammonia molecule, giving a Q of  $10^{18}$ , frequency and time could be determined to better than one part in a billion billion (1,000,000,000,000,000,000).

However, the line is broadened by other factors which lower the Q to a value of from 50,000 to 500,000, depending on the temperature and pressure of the gas. This may be compared to Q values of roughly 50,000 for a good cavity resonator in a microwave circuit and values of 1,000,000 or so for the best quartz crystals. The ammonia spectrum line thus has a Q approximating that of the best quartz crystals, though much more constant and stable.

The ammonia molecules in the absorption cell are moving rapidly in random thermal motion at an average speed of almost 2000 feet per second at room temperature. When a gas molecule in an absorption cell is approaching or receding from the source of an electromagnetic wave because of its heat motion, its absorption frequency is different from that which it would have if it were standing still. This gives rise to a "Doppler broadening" of the absorption line, analogous to the change in pitch of sound as its source approaches, passes, and leaves an observer. Thus, the line width can be reduced slightly by lowering the temperature of the gas (or by using a heavier molecule). Doppler broadening lowers the Q of the ammonia line to about 330,000 at room temperatures.

Molecular collisions also broaden the absorption line. This broadening occurs because the collisions abruptly terminate the absorption process, causing the molecules to absorb wave trains whose lengths vary in a random way determined by the distribution of time intervals between collisions. A frequency analysis of these wave trains shows a corresponding random distribution of absorbed frequencies, all centering about a mean value determined by the number of collisions per second. In ammonia gas at a pressure of 10 microns there are about 120,000 collisions per second, giving an experimentally measured Q of 45,000 for



the absorption line used. (This is the line known to spectroscopists as the 3,3 line, for which the quantum numbers J and K are each equal to 3.)

Actually, there are more collisions effectively interrupting the absorption process in ammonia than the kinetic theory of gases would indicate. Further broadening of the line results from collisions of the molecules with the walls, and even near misses between molecules cause interaction strong enough to interrupt absorption. The number of collisions per second, and thus the collision broadening, can be reduced by lowering the gas pressure. This process, if not carried too far, does not reduce absorption in the gas, because the decrease in number of molecules absorbing energy is offset by the increase in absorption per molecule resulting from the increase in  $Q$ . However, when the pressure is reduced too much, a phenomenon known as saturation of the line sets in, caused by an excess of radiation. Too few molecules are then left in the proper energy states to absorb the microwave radiation coming into the cell. Many molecules, which normally would be in the proper energy state to absorb the incoming radiation, are in an excited state as a result of previous absorption. Eventually these molecules will emit the quanta which they have absorbed, returning to the normal level where absorption is again possible. However, as this process is slow, the molecule usually returns to the ground level in a collision with another molecule, converting the absorbed radiation into heat. As the gas pressure is lowered, the number of collisions is greatly reduced, and not enough molecules return to ground levels. The excessive incoming radiation then weakens and broadens the absorption line through saturation. The broadening results because saturation occurs earlier at the peak of the line than out at its wings.

Saturation can be eliminated by reducing the strength of the incoming radiation. However, as the gas pressure and radiation intensity are both lowered, a condition will finally be met for which the signal strength will be down in the

natural electrical noise level of the circuits used to detect the signal. Circuit noise then sets the ultimate limitation on the reduction of collision and saturation broadening. It is estimated that a Q of 300,000 to 400,000 can be attained at pressures of about one micron--still a long way from the Q of the natural line width. Assuming that effective Q values of 400,000 can be obtained with ammonia, an accuracy of one part in 100 million or better should be possible since a measurement of the center of the absorption line to within  $1/250$  of the width of the line could be made.

#### Applications and Significance

Improvement of the accuracy of the atomic clock will make it useful in several fields of pure and applied science. The lengths of the mean solar day, used in astronomical measurements, fluctuate as much as one part in 20 to 30 million, because of variations in the rate of rotation of the earth on its axis. The variation in present time standards, due to these fluctuations, causes errors in the location of heavenly bodies and in studies of their orbits and motions. The atomic clock offers the possibility of an invariant master clock against which the variation in the earth's time-keeping could be measured. An absorption cell on an atomic clock could, for some purposes, take the place of an astronomical observatory.

Broadcasts of standard frequency are of importance in keeping all kinds of radio, radar, and electronic equipment properly tuned throughout the world. This service is required in international transportation and communications so that, for example, an airplane with radio navigational equipment will be using the right frequency wherever it is in the world and whatever airport it is using. At present, the National Bureau of Standards Station, WWV, broadcasts standard frequency and time signals on several transmitter frequencies to all

the world. The Navy Department also uses quartz-crystal clocks to broadcast time signals for navigational purposes. These quartz-crystal clocks drift slightly in frequency and have to be adjusted to keep them in agreement with the basic astronomical time signals. Clocks of this type could be kept constant automatically by means of absorption lines.

Maintenance of transmitter frequency to within close limits is also necessary to utilize the available radio spectrum efficiently. The use of long-distance standard frequency broadcasts is complicated by a large reduction in accuracy due to ionospheric effects. A long distance, short-wave signal travels around the earth by reflection from the upper ionized regions of the atmosphere, known as the ionosphere. Every morning at sunrise the ionosphere moves downward, and every evening at sunset it rises. This daily variation in height causes a Doppler shift of the frequency of the reflected wave and, together with other as yet unknown causes, is responsible for a reduction by a factor of 25 or more in the accuracy of the frequency of the received signal. Thus, the Bureau's standard frequency broadcast agrees with astronomical time signals to one part in one hundred million at the transmitter but may be known to only one part in four million after transmission over long distances. This difficulty can be partly overcome in several ways. One is the provision of a local, precise frequency standard calibrated by means of received standard time signals also transmitted by radio. However, this process, which requires a day or more, complicates the equipment problem and introduces additional errors, making impractical the use of standard frequency broadcasts for instantaneous or continuous frequency calibrations of the highest precision.

At the last International Radio Conference held in Atlantic City in 1947, plans were formulated to provide standard frequency and time broadcasts from many stations located to render good service throughout the world. These services may

be improved or simplified by means of atomic clocks and frequency standards. Such clocks could control the standard frequency emissions of the various stations without checking and monitoring by astronomical time signals. The Doppler frequency shifts could then be eliminated by limiting transmission distances to short ranges. Also, equipment anywhere in the world could be checked against an absorption line with the certainty of obtaining a precision calibration against an absolute standard and without depending on a standard frequency broadcast.

One advantage of the rotating earth as the basic time-keeper is that it never stops rotating or breaks down. Likewise, any man-made clock must not break down but must be kept running forever if it is to keep track of time from some arbitrary instant chosen as a starting point. With the present quartz-crystal clocks, this difficulty is met by using a large number of similar clocks constantly inter-compared so that breakdown of one does not mean a loss of time-keeping records. While this procedure could also be used with atomic clocks, it would not be necessary for use of the clock as a frequency standard or for defining a standard of time-intervals since these applications do not require continuous operation of the atomic clock.

The atomic clock should permit improvement in astronomical time standards in a way impossible with electric-pendulum or quartz-crystal clocks. It thus opens the possibility of improving the precision of knowledge of the length of the year, that is, the time it takes the earth to revolve once in its orbit around the sun. This is independent of the time it takes the earth to rotate once on its axis-- the mean solar day. Measurements could then determine whether the mean sidereal year is more constant than the mean solar day, as some astronomers believe may be the case.

Although the use of atomic time presents advantages in many fields of science, it will always be necessary for some purposes to have astronomical time

standards. This is because the pointing of a telescope depends on the orientation of the earth at the instant of observation, in other words, on astronomical time measurements which derive from the motion of the earth.

#### The NBS Program and Microwave Spectroscopy

The atomic clock program is being carried on at the National Bureau of Standards along several different lines. Among these is a project being developed with the cooperation of the atomic beam laboratory of Columbia University which may result in greatly improved accuracy. In this method, quantum transitions in beams of atoms such as cesium will be used to establish frequency and time standards. The broadening of the lines by collisions and Doppler effect is largely eliminated in this method so that the potential accuracy is increased by a factor of 10 to 100 or more. Calculations show that an ultimate accuracy of one part in ten billion may be reached. The atomic beam is again used in conjunction with a quartz-crystal oscillator and frequency multiplier system, just as in the present method using an absorption cell.

The chemical analysis of many heavy molecules by means of a microwave spectroscope has been carried out by many investigators. This makes it highly desirable to place frequency standards on an atomic basis at an early date in order that better precision can be obtained in the measurement of molecular constants. More and more chemicals will be analyzed as the technique is pushed to higher and higher frequencies in the microwave region. Spectroscopic analysis has hitherto been dependent on infrared, optical, and ultraviolet methods, which for the most part are limited to work on atoms and the simpler molecules. However, a large part of medical and industrial chemistry requires analysis of large, complicated molecules. The heavy molecules, rotating at slower rates, usually have spectrum lines in the microwave region so that the recent advances

in microwave measurement technique now provide highly accurate methods for the study of molecular constitution. Such large molecules are principally involved in the fields of high polymers, plastics, rubber, textiles, oil, foods, drugs, and biological chemicals such as vitamins.

Stable isotopes which are now available from the Atomic Energy Commission, are being widely applied in industry and medicine, and it is becoming important to have quick, accurate instruments for measurements of the kind and quantity of isotopes present in a sample. Isotopic identification is not possible by ordinary chemical methods, which deal only with the outer parts of an atom or molecule and not with the nucleus. The microwave spectrometer, having a resolution up to 100,000 times greater than an infrared spectroscope, will be able to make measurements on minute isotopic samples, and it can be built to do this quickly and accurately with automatic, all-electronic components.

One of the most important applications of quartz crystals is to the frequency-control of transmitters and filters used in radio equipment--both military and civilian. If these transmitters varied in frequency, radio and television sets would constantly have to be retuned, and much interference between adjacent channel transmitters would also result. Telephone companies operate carrier telephone circuits in which large numbers of simultaneous messages are transmitted over the same cable and are separated by means of crystal filters. Similar needs are met in microwave relay networks used for simultaneous communications, television, and FM broadcasting. At the higher frequencies, which are inaccessible to crystal oscillators or filters, the need for frequency-control equipment is urgent. Here atomic oscillators and spectrum lines used as filters would give the necessary frequency control and stability. A filter would consist of a cell filled with a gas that would absorb many different frequencies. A band-pass rather than a band-stop filter can also be made by means of additional microwave components called

magic tees. Such filters could be electrically tuned by making use of the Stark effect, in which an applied electric field can force a molecule to change its frequency.

Stable oscillators for controlling high-frequency transmitters can be made by using a method similar to that in the present atomic clock. Here a discriminator or servo circuit locks the transmitter to a spectrum line through a control signal generated by the servo whenever the frequency drifts. However, it would be advantageous to eliminate the servo or discriminator and develop an atomic oscillator in which the absorption line would directly determine the frequency of the oscillator or transmitter. This would be analogous to a low-frequency quartz-crystal oscillator and make possible many new applications to microwave radio systems.

Dr. Harold Lyons, in recent work at the National Bureau of Standards, has designed circuits of this type for use in transmitter control and for making an atomic clock and frequency standard without using discriminator circuits. In this method, the atomic-oscillator frequency is reduced by means of frequency dividers, but no quartz crystal-driven frequency-multiplying chain is used, as in the present clock, nor is any servo circuit required. The circuit is that of a feedback oscillator in which feedback is obtained for the amplifier through a magic tee only at the absorption line frequency. The tee is balanced at other frequencies, but the absorption occurring at the resonance frequency of the line unbalances it and allows the signal to be passed through so that the amplifier oscillates. This circuit requires a microwave amplifier at the frequency of the absorption line. Such amplifiers have been built, but are not yet commercially available, at 24,000 Mc where the ammonia lines are found.

Meanwhile, an exact equivalent of this circuit has been set up at 3,000 Mc, where amplifiers are now available. This circuit uses a resonant cavity in an

equivalent circuit of the absorption line. As the oscillator has functioned satisfactorily, an attempt is being made to find suitable absorption lines in the 3,000-Mc region. This involves a search for the lines of deuterated ammonia, in which some of the hydrogen atoms in the ammonia molecules have been replaced by heavy hydrogen (deuterium) atoms. The heavier deuterated ammonia will give lines at lower frequencies than ordinary ammonia. For example, when all three hydrogen atoms have deuterium atoms substituted for them, the frequency will go down to approximately 1,200 Mc. The National Bureau of Standards plans to construct a magic-tee atomic oscillator using the lower-frequency ammonia lines. Another atomic oscillator to be constructed at the Bureau will be similar to the magic-tee type but will use a six-arm waveguide bridge to control the feedback of the amplifier. This circuit should largely eliminate possible effects of the external circuits on the frequency of the oscillator. Thus, the oscillator, controlled by the absorption line alone, should be especially suitable for primary atomic clocks and frequency standards. Analogous circuits at low frequencies, using quartz crystals in ordinary bridges, have become the most precise quartz crystal oscillators so far constructed. The relative merits of the magic-tee and bridge circuits are being investigated.

The atomic clock may eventually be used to improve the standard frequency and time broadcasts of the National Bureau of Standards, both from Station WWV and the Bureau's new station in Hawaii, WWVH. This could be done by monitoring the present quartz-crystal clocks with an atomic clock and would be especially useful at the Hawaiian transmitter. A precise atomic clock would give the Bureau a time standard analogous to the Bureau's new atomic standard of length provided by the invariant wavelength of the light from a single mercury isotope ( $\text{Hg}^{198}$ ).

The goal of using spectrum lines of individual, isolated atoms in a field-



free space to establish time and frequency standards is most nearly attained in the method using quantum transitions in atomic beams. Both this method and the method using absorption cells stem from the application of atomic physics to practical problems. In fact, quantum mechanics must be used to calculate and design the necessary apparatus, and the absorption by ammonia gas is a typical quantum mechanical effect incapable of explanation by classical physics. The ammonia molecule, structurally like a pyramid with the three hydrogen atoms forming the triangular base and the nitrogen atom at the apex, continually turns itself inside-out, giving rise to a quantum-mechanical resonance absorption. The atomic clock is thus another example of the importance of atomic physics to engineering. The overlapping of the fields of electronics and microwave physics may well provide a new technique for opening up the millimeter-wavelength bands above the region where ordinary microwave methods are applicable and below the region of optical methods.

1/ Microwave frequency standards, Harold Lyons, Physical Review, 74, 1203, Nov. 1, (1948). The first discussion of the atomic clock, presented at the meeting of the American Physical Society in Washington, D. C., on April 30, 1948.

2/ Somewhat similar pulse circuits were first used in a stabilized klystron oscillator by Dr. W. D. Hersberger of the RCA Laboratories, Princeton. Such an application is fortunately simpler than the application to an atomic clock, which must work with much lower signal levels.

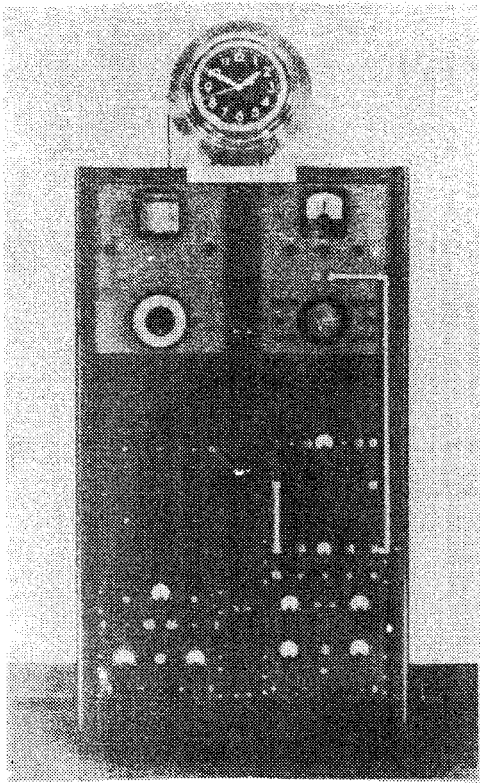

FIGURE 1

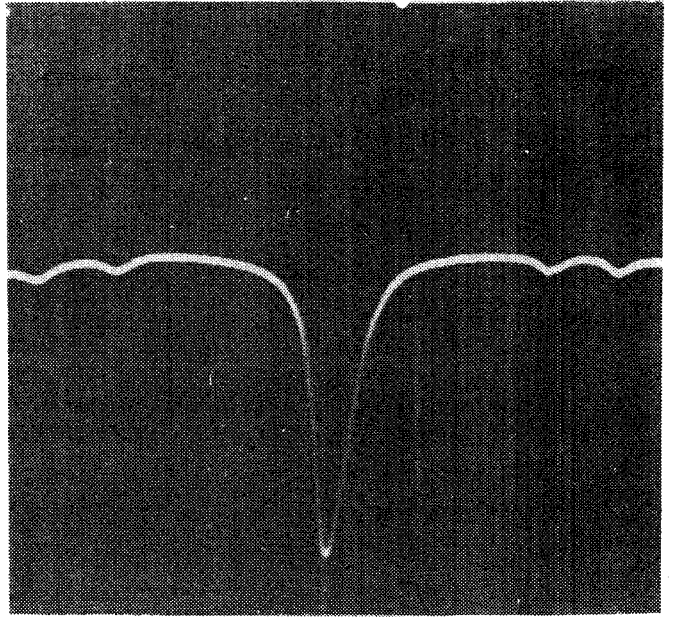

FIGURE 3

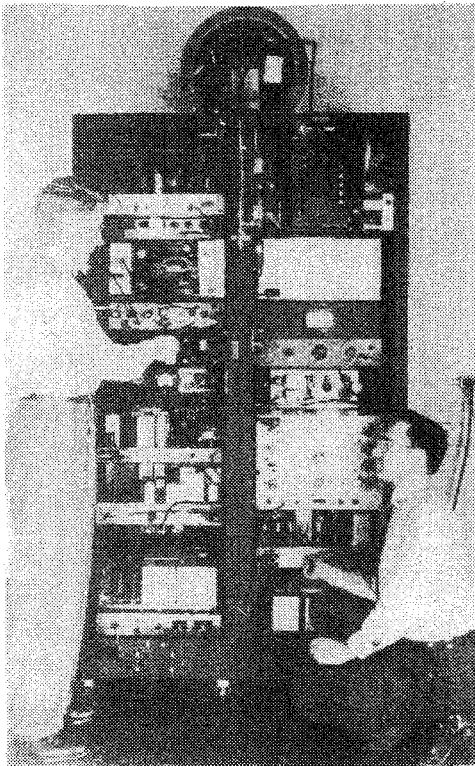
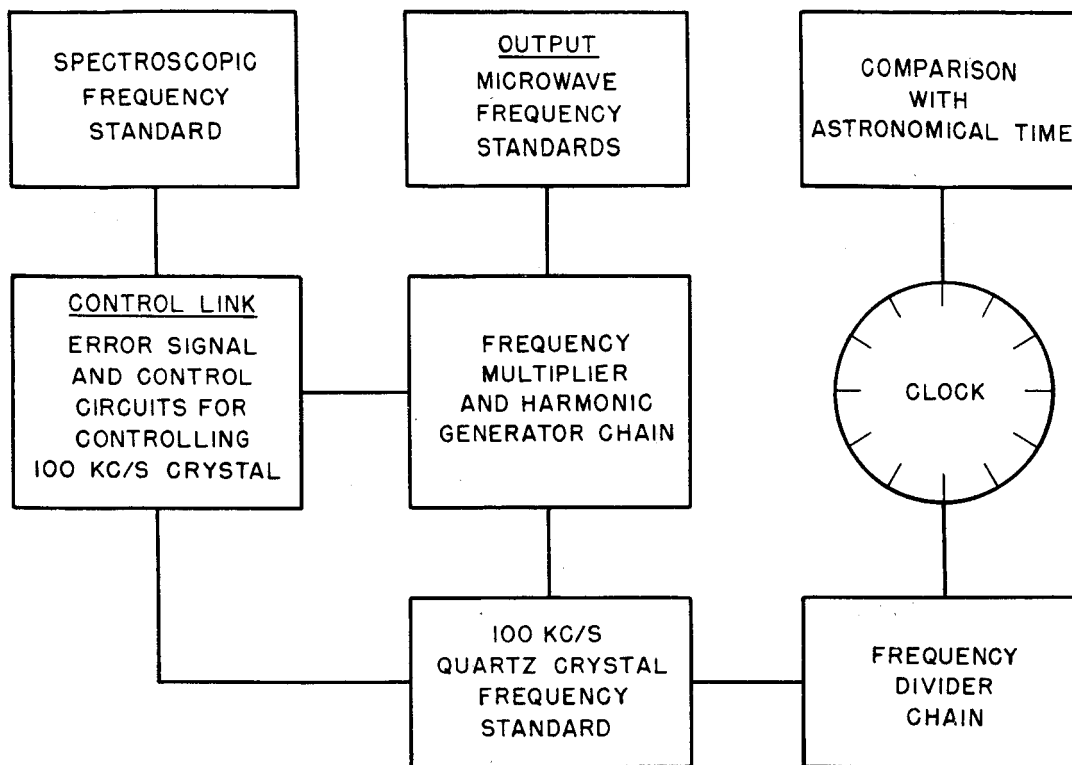

FIGURE 2



FIGURE 4



SIMPLIFIED BLOCK DIAGRAM OF NBS ATOMIC CLOCK  
FIGURE 5.

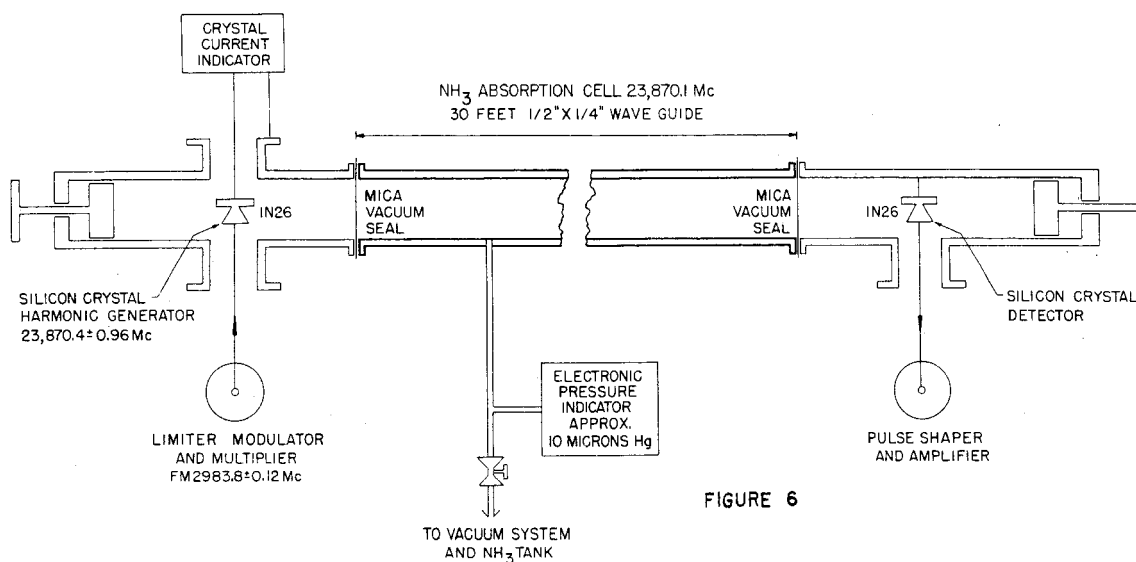

FIGURE 6

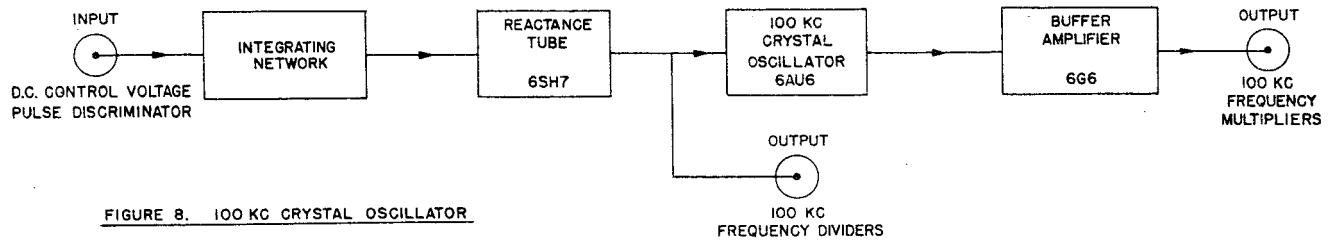

FIGURE 8. 100 KC CRYSTAL OSCILLATOR

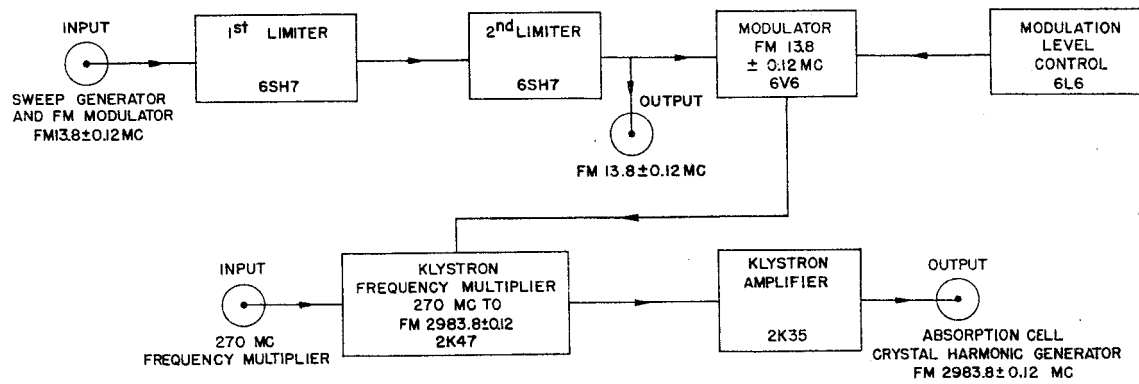

FIGURE 9. LIMITER, MODULATOR, AND MULTIPLIER

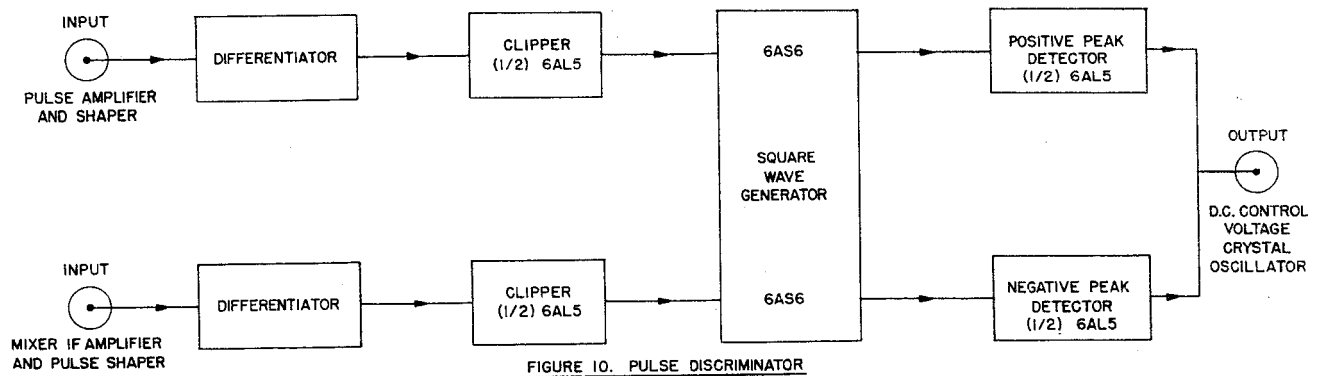
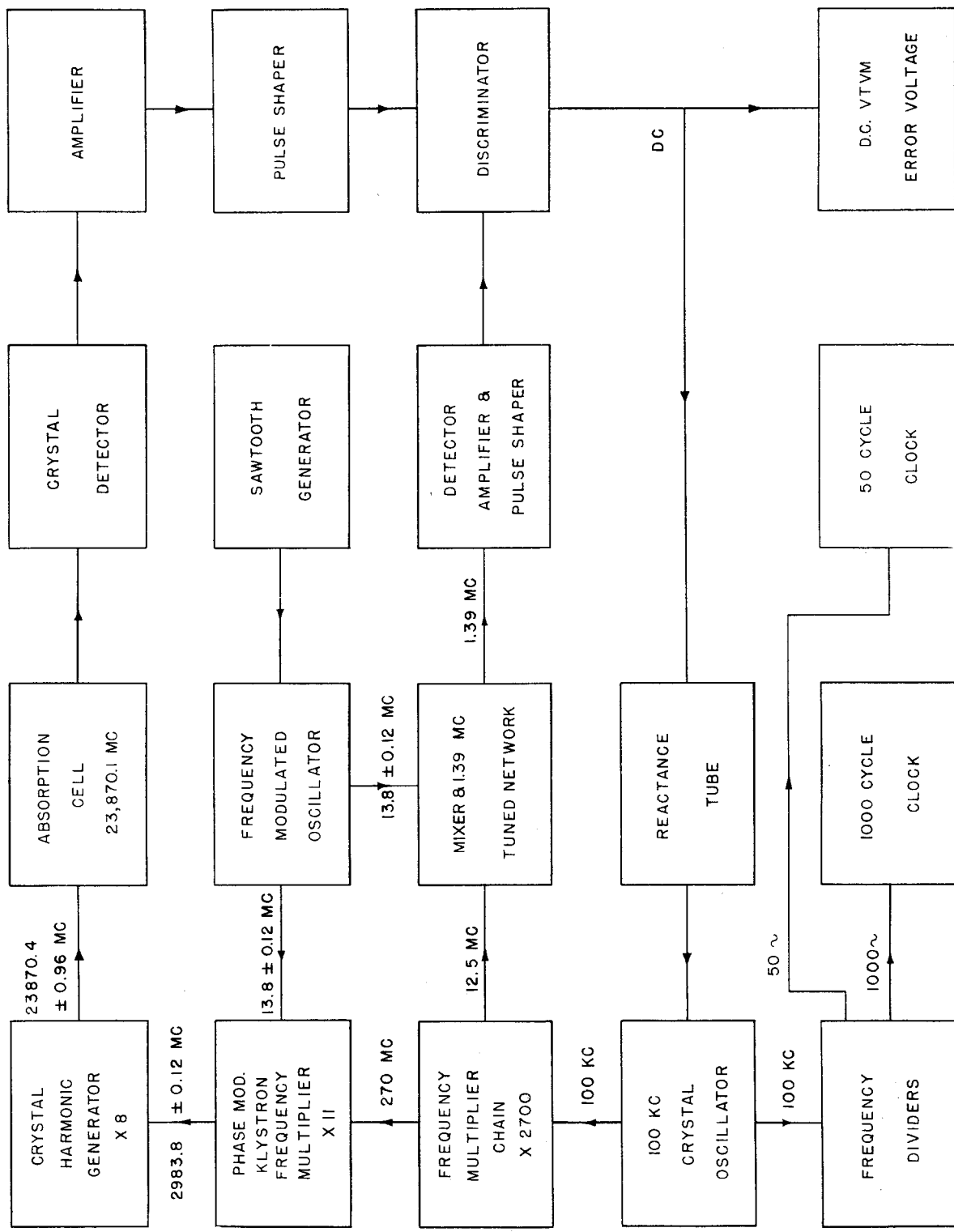

FIGURE 10. PULSE DISCRIMINATOR



COMPLETE BLOCK DIAGRAM OF NBS ATOMIC CLOCK  
FIGURE 7

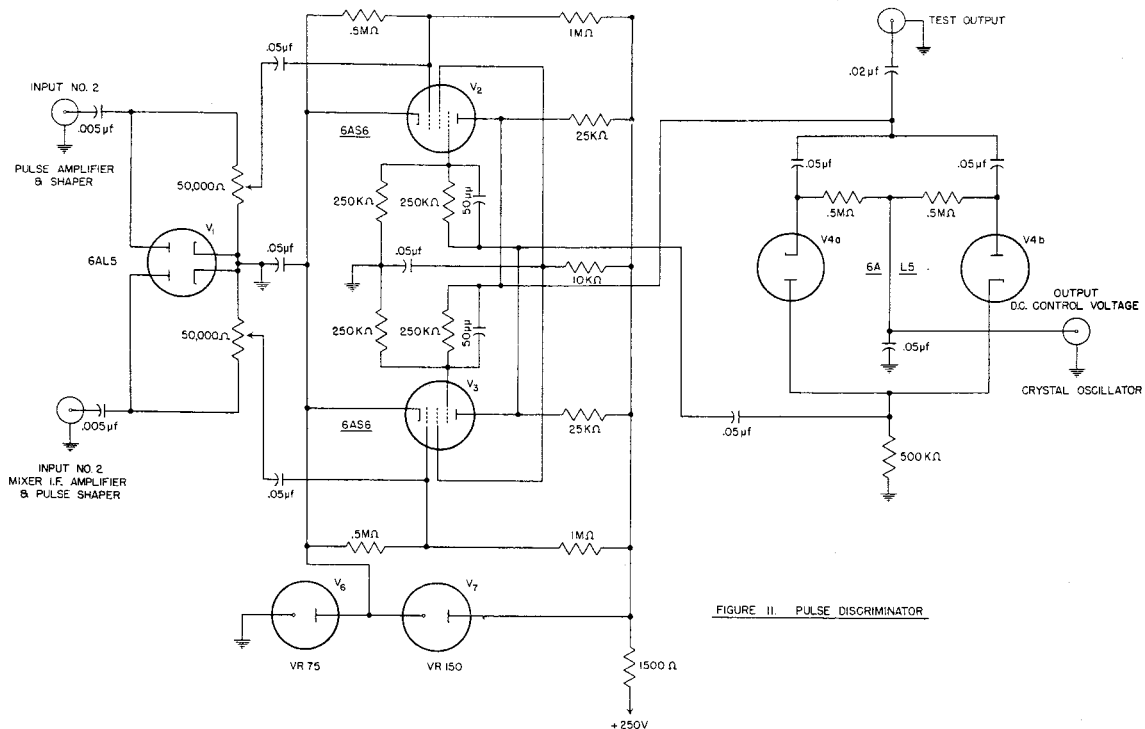

FIGURE 11. PULSE DISCRIMINATOR

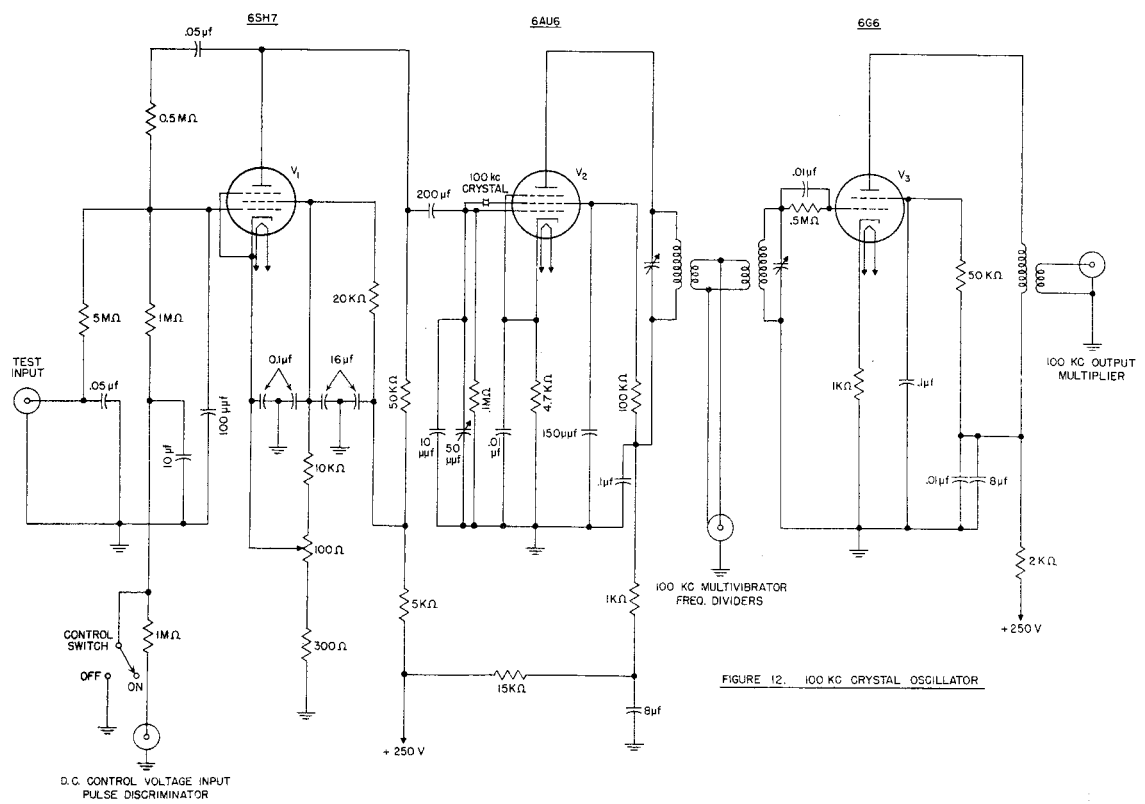

FIGURE 12. 100 KC CRYSTAL OSCILLATOR

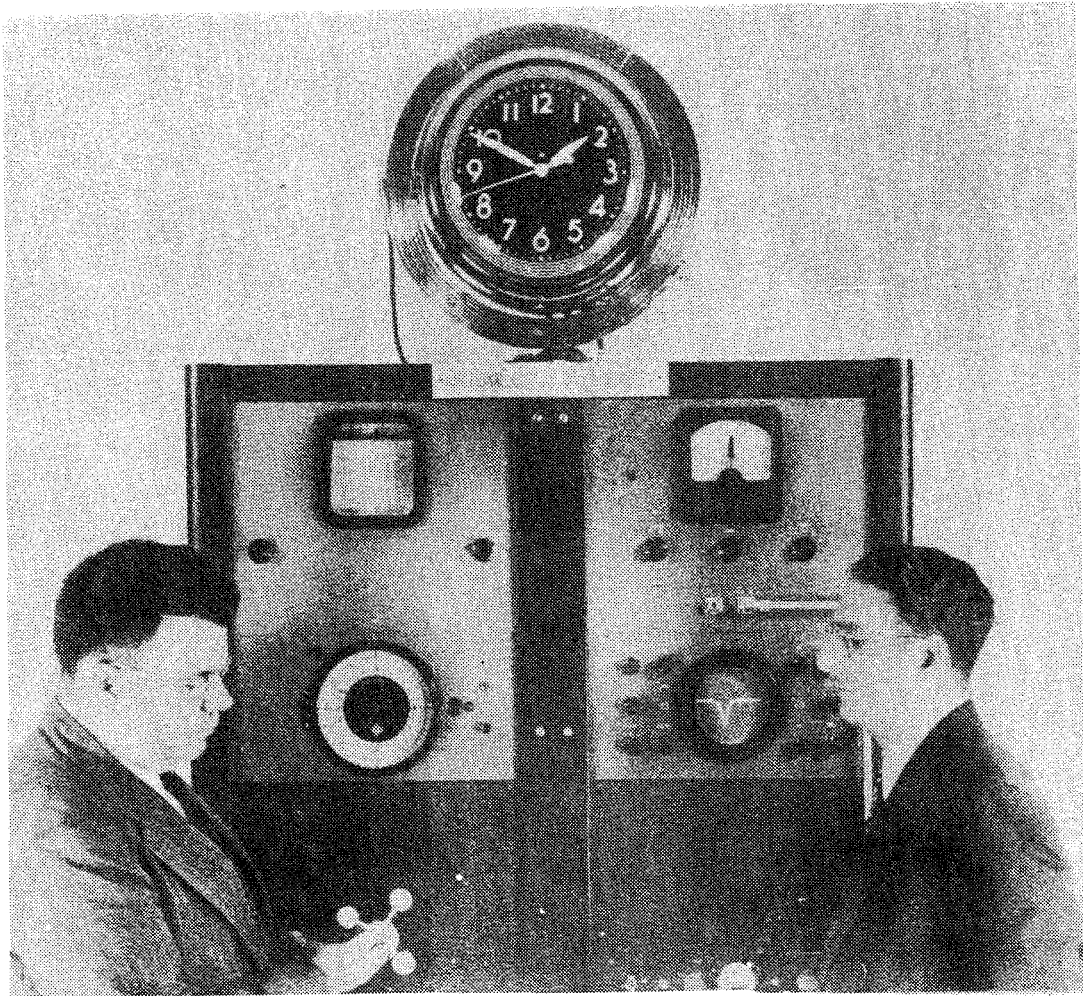

FIGURE 13

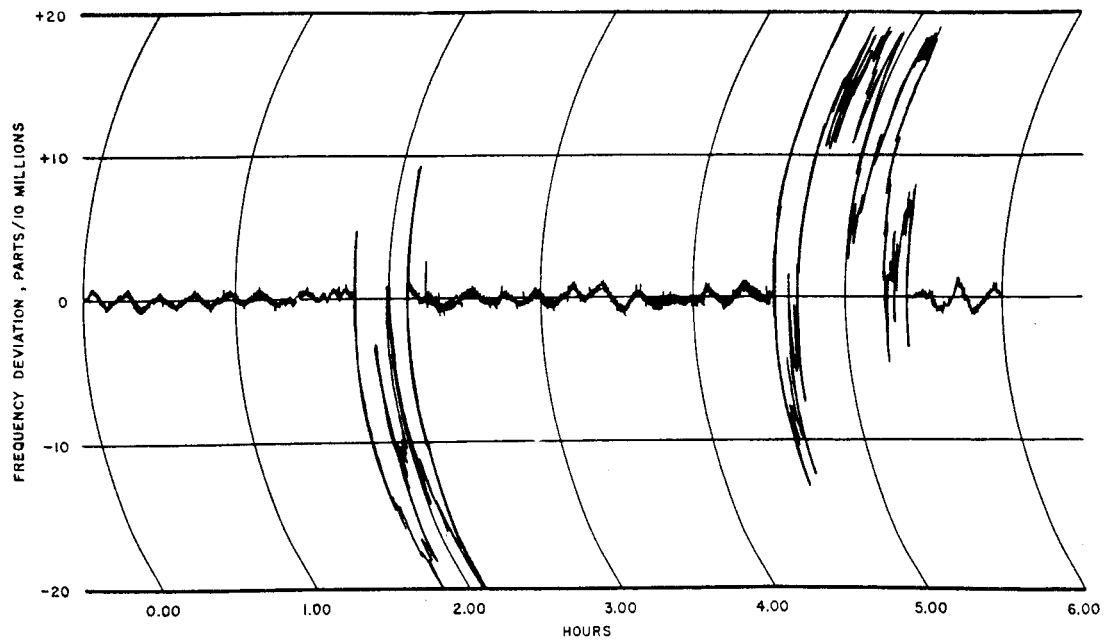

FIGURE 14

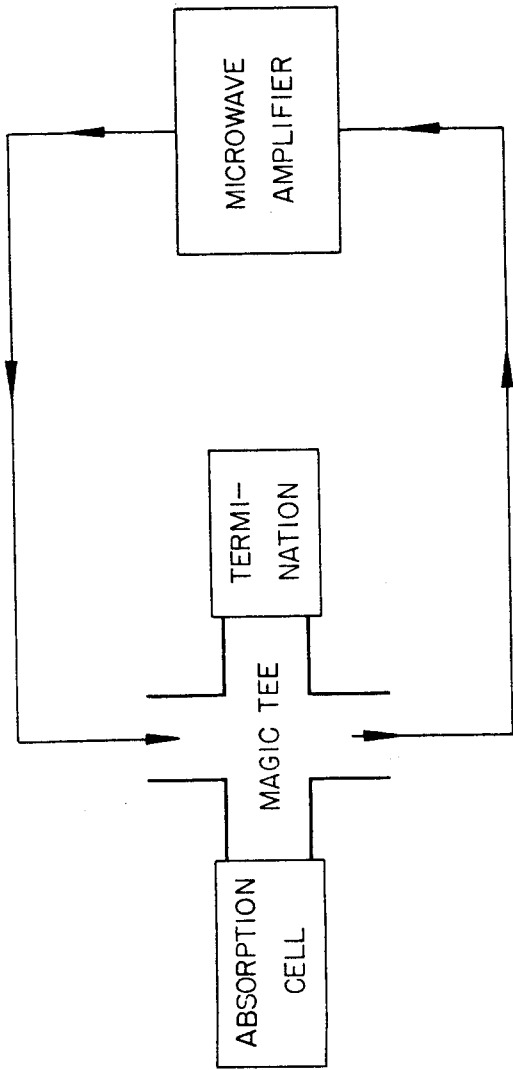
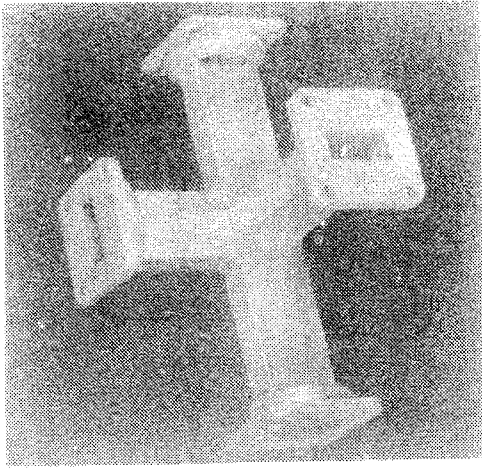

FIGURE 15

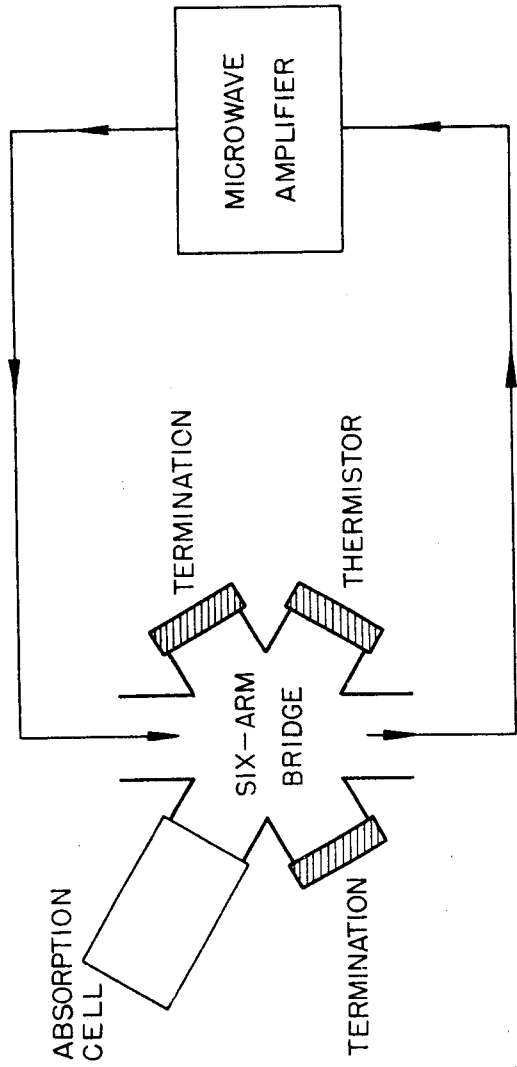
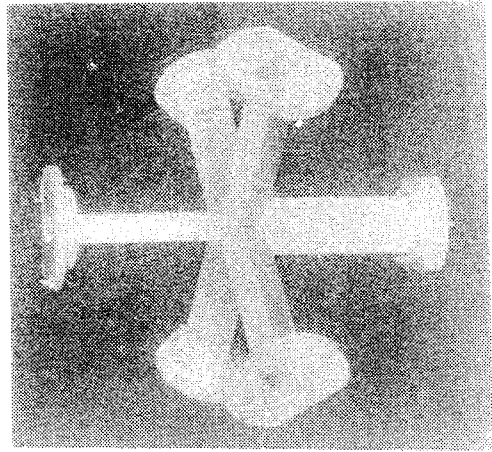

FIGURE 16



CAPTIONS FOR ILLUSTRATIONS:

Figure 1. - The new atomic clock at the National Bureau of Standards is completely contained in this unit with the electronic equipment housed in a standard rack cabinet and the waveguide absorption cell wound in a spiral around a 50-cycle synchronous clock on top of the cabinet. From top to bottom, on the left panels: frequency deviation recorder; 1000-cycle synchronous motor clock (24-hour dial); electronic frequency meter (drives deviation recorder); 100-kilocycle quartz-crystal oscillator; frequency dividers (divide 100 kc down to 50 and 1000 cycles); regulated power supply for klystron tubes; regulated plate and filament power supply. On the right panels: frequency comparator and deviation indicator; monitoring oscilloscope; pulse amplifiers and shapers, and pulse discriminator; d-c control voltage indicator; sweep generator, FM modulator, and klystron frequency multiplier (270 mc to 2984 mc); frequency multiplier (100 kc to 270 mc); electronic vacuum gage; regulated plate and filament power supply.

PHOTO 17857-1-320

Figure 2. - Details on size and construction of the atomic clock, developed at the National Bureau of Standards, appear in this general view of the back of the equipment. E. F. Husten (left) and E. D. Heberling (right), members of the staff at the NBS Microwave Standards Laboratory, are shown making adjustments on the clock's amplifier and power supply circuits. The amount of equipment shown is larger than needed for the clock alone since some of the instruments are for measurements and tests of performance. Actually, the circuits essential to the operation of the atomic clock could be condensed into one of the two cabinet racks.

PHOTO 17857-2-320

Figure 3. - While the NBS Atomic Clock is in operation, the monitoring oscilloscope continuously displays a trace of the 3,3 absorption line of ammonia. The 3,3 line, strongest of many absorption lines in ammonia, corresponds to the quantum transition in which the quantum numbers J and K both have the value 3. The symmetric output pulse is produced by absorption of the FM control signal as it sweeps across the natural absorption-line frequency of the ammonia gas. The sharpness of this line on the oscilloscope screen is an indication of the time-keeping accuracy of the atomic clock. A frequency scale may be inferred from the known frequency interval (1.74 Mc) between the main 3,3 pulse and the first satellite pulse on either side (the satellites are produced by nuclear quadrupole moments of  $N^{14}$ ). This shows that the width of the 3,3 absorption line at the half-power points is about 0.335 Mc; dividing the center frequency (23,870 Mc) by this half-power value yields a Q of 71,200.

PHOTO 17857-4-320

Figure 4. - The quantum transition by which the ammonia molecule (top),  $NH_3$ , absorbing energy at one sharply defined frequency, can turn itself inside out is illustrated in classical terms by the schematic diagram (bottom). An absorption line produced by such a transition serves as the frequency control for the NBS Atomic Clock. The ammonia molecule is in the form of a pyramid with a nitrogen nucleus at the apex and three hydrogen nuclei at the base; each nucleus is surrounded by its characteristic electron charge. The Average distance between the nitrogen nucleus and each hydrogen nucleus is 1.01 Angstroms; that between the hydrogen nuclei is 1.63 Angstroms. The pyramid is about 0.38 Angstroms high, and the H-N-H apex angle is  $107^\circ$ .

PHOTO 17857-3-320

Figures 5 and 6.

Figure 5. - Simplified block diagram of the National Bureau of Standards Atomic Clock. The fundamental driving signal originates in the 100-kilocycle quartz-crystal oscillator. The frequency-multiplier and harmonic-generator chain then multiplies this signal up to microwave frequencies by means of vacuum-tube circuits and silicon-crystal diodes, providing output signals throughout the microwave range. Frequency-discriminator circuits in the control link then compare the frequency of these signals with the ammonia frequency standard. After the microwave signal is exactly tuned to the frequency of the spectrum line, any tendency to drift on the part of the quartz-crystal oscillator will cause the discriminator circuits in the control link to send an "error signal" back to the oscillator, maintaining it at the proper frequency. The crystal oscillator is thus locked to the invariant frequency of the ammonia line. A frequency divider chain then drives a synchronous-motor clock, first reducing the stabilized 100-kilocycle signal to the clock frequency.

Figure 6. - The waveguide absorption cell used in the NBS Atomic Clock is a rectangular copper tube wound in a compact spiral and provided with mica windows to seal in the ammonia gas at reduced pressure. A 2983.8-megacycle signal is fed through a coaxial cable to a type-1N26 silicon-crystal rectifier inside the waveguide. This crystal rectifies the input current and generates strong harmonics which radiate down the waveguide. Tuning plungers are shown at the input and output of the cells for impedance matching so that all of the signal is used and none reflected. The present 30-foot cell gives a two-to-one total reduction in signal amplitude. After passing through the absorption cell, the signal is received by another type-1N26 silicon-crystal rectifier. This rectifier, acting like a receiving antenna, generates an output current which dips due to absorption as the input frequency sweeps across the absorption-line frequency.

PHOTO 17857-5-320

Figure 7. - The fundamental driving signal for the NBS Atomic Clock originates in the 100-kilocycle quartz-crystal oscillator (lower left). A frequency-multiplying chain using ordinary radio tubes multiplies the signal up to 270 megacycles; a frequency-multiplying klystron then multiplies the signal 11 more times and combines it with a signal from a frequency-modulated oscillator to produce an FM output signal at  $2983.8 \pm 0.12$  Mc. A silicon-crystal harmonic generator multiplies this FM signal up to  $23870.4 \pm 0.96$  Mc and introduces it into the ammonia absorption cell. As the frequency of the modulated control signal sweeps across the absorption-line frequency of the ammonia vapor, the signal reaching the silicon-crystal detector at the end of the absorption cell is decreased, giving an output pulse which is strengthened and sharpened in the amplifier and pulse shaper. A second pulse is generated by combining in a mixer the output of the FM oscillator and a 12.5 megacycle signal from the frequency multiplying chain. The time interval between the pulse from the absorption cell and the pulse from the mixer can then be measured in the discriminator. The discriminator gives zero output when the time interval is right; but when the interval is wrong, it sends a control signal to the reactance tube, which retunes the crystal oscillator accordingly. The crystal oscillator is then stabilized against drift and can maintain the timekeeping of the synchronous-motor clocks with extreme accuracy.

PHOTO 17857-6-320

Figures 8 through 10.

Figure 8. - The 100-kilocycle frequency standard employs a quartz-crystal oscillator with a reactance-tube control circuit. The "error signal" from a frequency discriminator is passed through the integrating circuit, which smooths out all fluctuations in the error signal except steady changes generated when the circuit tries to drift in frequency. The output voltage of the integrating circuit, applied to the reactance-tube grid, controls the tuning of the crystal oscillator. The oscillator output is fed to a frequency divider and also, through the buffer amplifier, to a frequency multiplier.

Figure 9. - The limiter, modulator, and multiplier arrangement uses a klystron tube to multiply the 270-megacycle input signal 11 times before combining it with an FM signal of  $13.8 \pm 0.12$  Mc. The resulting output signal,  $2983.8 \pm 0.12$  Mc, is then amplified in another klystron and fed to the harmonic generator at the input of the ammonia absorption cell. Klystron tubes are used here because of the extremely high frequencies involved.

Figure 10. - In the pulse discriminator, the two pulses between which the time interval is to be measured turn a trigger circuit or square-wave generator on and off. When the time interval is correct, the on-off cycle generates no output signal from the positive and negative peak detectors driven by the square-wave signal. The detectors draw current on the positive and negative peaks of the square wave, but when the positive and negative portions of the square wave are of equal duration, they balance and give no d-c output. However, if the time interval between the two input driving pulses gets longer or shorter, the relative duration of the positive and negative parts of the square wave changes so that a resultant d-c output is generated. No control voltage is generated when the quartz-crystal oscillator is on the proper frequency to tune the frequency-multiplying chain to the ammonia line, but a control voltage is produced to retune the oscillator if it is tending to drift.

PHOTO 17857-7-320

Figures 11 and 12. - Schematic circuit diagrams of the pulse discriminator and the 100-kilocycle quartz-crystal oscillator used in the NBS Atomic Clock,

PHOTO 17857-8-320

Figure 13. - Dr. E. U. Condon (left), Director of the National Bureau of Standards and Dr. Harold Lyons, inventor of the NBS Atomic Clock, stand before the control panel of the clock. Dr. Condon is holding a model of the ammonia molecule whose microwave absorption line (shown on the oscilloscope screen at right) provides the invariant frequency which controls the timekeeping of the clock. The ammonia gas is maintained at low pressure in the 30-foot absorption cell wound around the synchronous clock (directly above the scientists).

PHOTO 17857-9-320

Figure 14. - The frequency-deviation record reproduced here shows the actual variations in timekeeping accuracy of the NBS Atomic Clock during a six-hour test run. The narrow portions of the deviation trace, recorded while the clock was locked to the ammonia absorption line, indicate a constancy of one part in ten million. When the control circuit was unlocked, large frequency variations occurred, as shown by the broad portions of the recorder trace.

PHOTO 17857-10-320