

U. S. DEPARTMENT OF COMMERCE
NATIONAL BUREAU OF STANDARDS
CENTRAL RADIO PROPAGATION LABORATORY
WASHINGTON, D. C.

THE MICROWAVE FREQUENCY STANDARD AT
THE CENTRAL RADIO PROPAGATION LABORATORY

BY W. D. GEORGE, H. LYONS, J. J. FREEMAN AND J. M. SHALL

THE MICROWAVE FREQUENCY STANDARD AT
THE CENTRAL RADIO PROPAGATION LABORATORY

By W.D. George, H. Lyons, J.J. Freeman and J.M. Shaul

Abstract

This report describes the equipment set up in 1945 at the National Bureau of Standards to generate standard microwave frequencies and to make microwave frequency measurements, tests and calibrations. All frequencies are derived from, or measured directly, in terms of the National primary standard of frequency, the absolute accuracy of which is known at all times to better than 1 part in 100 million. Highly constant oscillators of narrow tuning range are mixed with the multiplied standard frequencies making available an 8% bandwidth at output center frequencies of 29.7, 89.1, 267.3 and 801.9 Mc/s. Harmonics of these output frequencies, generated by silicon-crystal multipliers, give continuous coverage of the range from 342 to somewhat above 30,000 Mc/s with a known accuracy of 1 part in 10 million or better. In this range a total of over 870 fixed frequencies of approximately 1% separation, entirely generated from the primary standard and accurate to 1 part in 100 million, are also made available. Measurements are normally made at controlled temperature and humidity in a shielded room. Absolute accuracy of calibration is usually considerably less than that of the reference frequencies, being limited by the operating band-pass characteristic and dial mechanism for frequency meters, or by the short time frequency changes of oscillators under test. Instructions in the operation and maintenance of the equipment are given. Detailed descriptions, circuit diagrams and photographs of the individual units are also included.

Contents

General Description

1. Introduction
2. The calibration room
3. The primary standard of frequency
4. The frequency-generating equipment
 - a. General-coverage system
 - b. Fine-tuning and spot-frequency arrangement
 - c. Frequency-measurement equipment
 - d. Harmonic-generating and detection equipment
5. Accuracy of calibrations
 - a. Unknown oscillator frequencies
 - b. Frequency meter calibrations
 - c. Q measurements
 - d. Dependence of resonance frequency on temperature for cavities without temperature compensation
 - e. Dependence of resonance frequency on humidity
6. Calibration services of the National Bureau of Standards

(over)

Appendix

I. Operating instructions

1. Procedure for making calibrations using adjustable-frequency oscillators
2. Measurement of adjustable-oscillator frequencies
3. Use of fine-tuning and spot-frequency equipment
4. Operating technique and precautions in use of equipment
 - a. Frequency standard
 - b. Crystal multipliers
 - c. Spurious frequencies
 - d. Frequency meters
 - e. Spectrum analyzers

II. Detailed unit descriptions

(arranged in the following order for each unit)

- a. Description
 - b. Operation and service instructions
 - c. Parts list
 - d. Illustrations
1. Frequency multiplier; output 7.5 Mc/s
 2. Frequency converter-multiplier; output 28.5 to 30.9 Mc/s
 3. Adjustable-frequency oscillators; 2.0 to 2.4 Mc/s and 2.4 to 2.8 Mc/s
 4. Three-stage frequency multiplier; outputs 85.5 to 92.7 Mc/s, 256.5 to 278.1 Mc/s, 769.5 to 834.3 Mc/s
 5. Distribution amplifier; 100 kc/s
 6. Adjustable-frequency oscillator; 500 to 600 kc/s
 7. Frequency multiplier and dual frequency converter; outputs 1500 to 3000 kc/s, 1000 to 2000 kc/s, 2000 to 3000 kc/s
 8. Decade frequency generator; outputs at 100-kc intervals from 100 to 1000 kc/s
 9. Harmonic series generator
 10. Audio-frequency interpolation oscillator
 11. Multi-band receiver and monitoring speaker
 12. Wide-band oscilloscope
 13. Frequency divider; 100 kc/s to 10 kc/s to 1 kc/s to 0.1 kc/s

Illustrations

- Fig. 1. Block schematic of microwave frequency equipment at National Bureau of Standards
- Fig. 2. Frequency in Mc/s output of silicon-crystal frequency multiplier
- Fig. 3. Diagram of rack and panel arrangement of equipment
- Fig. 4. Diagram of shielded room and rack wiring
- Fig. 5. Photograph of complete microwave frequency standard
- Fig. 6. Photograph of complete microwave frequency standard with connecting leads
- Fig. 7. Photograph of spectrum analyzer, frequency meters, and crystal multiplier; 8,500 to 10,000 Mc/s
- Fig. 8. Layout drawing of frequency multiplier; 100 to 7500 kc/s
- Fig. 9. Circuit schematic of frequency multiplier; 100 to 7500 kc/s
- Fig. 10. Photograph of frequency multiplier; 100 to 7500 kc/s (top-front view)

- Fig. 11. Photograph of frequency multiplier; 100 to 7500 kc/s (bottom view)
- Fig. 12. Layout drawing of frequency converter-multiplier; output 28.5 to 30.9 Mc/s.
- Fig. 13. Circuit schematic of frequency converter-multiplier; output 28.5 to 30.9 Mc/s.
- Fig. 14. Photograph of frequency converter-multiplier; output 28.5 to 30.9 Mc/s (top-front view)
- Fig. 15. Photograph of frequency converter-multiplier; output 28.5 to 30.9 Mc/s (bottom view)
- Fig. 16. Layout drawing of adjustable-frequency oscillator; 2.0 to 2.4 Mc/s and 2.4 to 2.8 Mc/s
- Fig. 17. Circuit schematic of adjustable-frequency oscillator; 2.0 to 2.4 Mc/s and 2.4 to 2.8 Mc/s
- Fig. 18. Photograph of adjustable-frequency oscillator; 2.0 to 2.4 Mc/s and 2.4 to 2.8 Mc/s (top-front view)
- Fig. 19. Photograph of adjustable-frequency oscillator; 2.0 to 2.4 Mc/s and 2.4 to 2.8 Mc/s (bottom view)
- Fig. 20. Layout drawing of three-stage frequency multiplier and power supply.
- Fig. 21. Circuit schematic of three-stage frequency multiplier and power supply
- Fig. 22. Photograph of three-stage frequency multiplier (front view)
- Fig. 23. Photograph of three-stage frequency multiplier (top view)
- Fig. 24. Photograph of three-stage frequency multiplier (bottom view)
- Fig. 25. Photograph of power supply for three-stage frequency multiplier (top-front view)
- Fig. 26. Photograph of power supply for three-stage frequency multiplier (bottom view)
- Fig. 27. Layout drawing of distribution amplifier; 100 kc/s
- Fig. 28. Circuit schematic of distribution amplifier; 100 kc/s
- Fig. 29. Photograph of distribution amplifier; 100 kc/s (top-front view)
- Fig. 30. Photograph of distribution amplifier; 100 kc/s (bottom view)
- Fig. 31. Layout drawing of adjustable-frequency oscillator; 500 to 600 kc/s
- Fig. 32. Circuit schematic of adjustable-frequency oscillator; 500 to 600 kc/s
- Fig. 33. Photograph of adjustable-frequency oscillator; 500 to 600 kc/s (front view)
- Fig. 34. Photograph of adjustable-frequency oscillator; 500 to 600 kc/s (top view)
- Fig. 35. Photograph of adjustable-frequency oscillator; 500 to 600 kc/s (bottom view)
- Fig. 36. Layout drawing of frequency multiplier and dual frequency converter; outputs 1500 to 3000 kc/s, 1000 to 2000 kc/s, 2000 to 3000 kc/s
- Fig. 37. Circuit schematic of frequency multiplier and dual frequency converter
- Fig. 38. Photograph of frequency multiplier and dual frequency converter (front view)
- Fig. 39. Photograph of frequency-multiplier and dual frequency converter (top view)
- Fig. 40. Photograph of frequency multiplier and dual frequency converter (bottom view)
- Fig. 41. Layout drawing of decade frequency generator; outputs at 100-kc intervals from 100 to 1000 kc/s
- Fig. 42. Circuit schematic of decade frequency generator
- Fig. 43. Photograph of decade frequency generator (front view)
- Fig. 44. Photograph of decade frequency generator (top view)

- Fig. 45. Photograph of decade frequency generator (bottom view)
- Fig. 46. Circuit schematic of harmonic series generator
- Fig. 47. Photograph of harmonic series generator (top-front view)
- Fig. 48. Photograph of harmonic series generator (bottom view)

GENERAL DESCRIPTION

1. Introduction

The microwave frequency standard at the Central Radio Propagation Laboratory, National Bureau of Standards, makes use of the National primary standard of frequency by extending its range to cover the microwave region. This is done by multiplying the 100-ke frequency of the primary standard or a very constant and specially derived frequency measured in terms of the primary frequency, to give fixed points or complete coverage in the desired portion of the microwave spectrum.

2. The Calibration Room

The microwave frequency standard is installed in a temperature and humidity controlled, electrically-shielded room. Room temperature is normally held to $25^{\circ} \pm 1^{\circ} \text{C}$, at a relative humidity of $50\% \pm 2\%$. The room may be readily operated over a fairly wide range of temperature and humidity conditions if desired. The standard-frequency distribution lines and the a-c power line entering the shielded room are filtered to reduce interference from outside radio-frequency sources. The room is shielded with one layer of 5 oz. electrolytic sheet copper. All power supplied the room is regulated by external a-c regulators.

3. The Primary Standard of Frequency

The National primary standard of frequency consists of nine quartz-crystal-controlled oscillators which operate continuously and are automatically compared with Naval Observatory time and with each other. The absolute value of frequency from each of these standards is thereby known within 1 part in 100 million at all times. Short-time constancy (1 hour or less) of these standards is usually better than 1 part in 10^9 . Output from one or more of these oscillators is distributed to laboratory equipment where higher and lower standard frequencies are derived. One of the standard oscillators controls the continuous radio broadcast of standard frequencies from the Bureau's station WWV.

Details concerning the broadcast of technical radio services from station WWV are given in an announcement obtainable on request.

4. The Frequency Generating Equipment

a. General-Coverage System

The method by which other standard frequencies are derived from the primary frequency standard may be seen by reference to the block diagram in Fig. 1. The standard frequency, 100 kilocycles per second, is multiplied to a very-high or ultra-high frequency and then impressed across a silicon-crystal rectifier, the harmonics from which are selected to give the desired microwave standard frequencies. Continuous coverage is obtained by adding,

in a frequency converter, the output of precision, adjustable-frequency oscillators to the output of one of the multipliers and then continuing the multiplication.

Referring to Fig. 1 this process may be traced through in detail. The 100 kc/s is first multiplied to 7500 kc/s by conventional multipliers with sufficient filtering to reduce, to a very low value, all spurious side-frequencies and harmonics in the desired output. The resultant frequency is added to the output of oscillator A or B and then tripled to the 28.5 to 30.9 Mc/s range. Each of the precision oscillators A or B is adjustable over the range shown, with 8000 dial divisions and a very linear scale. After further multiplication, the final frequencies are obtained for application to the crystal-rectifier harmonic generators. The same types of crystals are used in the different ranges of frequencies for harmonic generators as are normally used as mixers or converters in receivers for these same frequency ranges. The frequencies available at points D, E, and F are generated by multipliers using 829B, 832A, and 2C40 tubes, respectively, and giving adjustable output levels as high as 2, 2, and 1 watts. Multiplier circuits are of the ordinary lumped-constant type except for the output circuit of the 270 Mc/s multiplier which uses parallel lines and the 810 Mc/s multiplier which uses a butterfly circuit.

It is seen that about 25% of the frequency stability of the output is derived from oscillators A and B while 75% is derived from the primary frequency standard. However, the instantaneous frequency of A or B may be determined by means of the usual calibrating equipment shown to the right in the block diagram. This equipment also serves to monitor the frequency of oscillator A or B if it is desired to maintain a given frequency over a period of time.

b. Fine-Tuning and Spot-Frequency Arrangement

For applications where finer control or a more constant frequency is needed the arrangement shown at the left in the block diagram is used. Here, the output from the adjustable oscillator C mixes with outputs derived from the decade frequency generator and multiplier to give continuous coverage from 2000 to 2800 kc/s, which is again mixed with the 7500 kc/s in the main converter in place of oscillators A or B. For example, to obtain outputs from 2700 to 2800 kc/s, the 900 kc output may be multiplied to 1800 kc/s and 400 kc/s added in converter L to obtain 2200 kc/s, to which the output from oscillator C may be added in converter K to obtain the desired output. It will be seen that most of the combinations in the range 2000 to 2800 kc/s may be obtained by using only two of the three channels in the multiplier-converter unit. Since the converter channels may also be used as multipliers in their tunable ranges, it is evident that many combinations are available in obtaining most of the desired output frequencies. The output constancy is accordingly now controlled to the extent of about 5% by oscillator C and 95% by the primary standard. The output frequency range is covered by 64,000 dial divisions which gives an adjustment of approximately 4, 12, and 40 kc/s per dial division at frequencies of 3000, 10,000, and 30,000 Mc/s, respectively. This is a frequency change of about 1 part in 10^6 per dial division, while oscillators A and B give a change of about 5 parts in 10^6 per dial division. An additional fine-adjustment control on oscillator C covers a range equal to ± 3 dial divisions for a 180° rotation.

The arrangement shown in the left in the block diagram of Fig. 1 also serves to give outputs from 2000 to 2800 kc/s, at 100 kc/s intervals, derived entirely from the primary standard. This gives fixed frequencies with an accuracy of 1 part in 10^8 or better at approximately 1% intervals throughout the range of the equipment. When using oscillators A or B for continuous coverage an accuracy of frequency of 1 part in 10^7 or better is obtained. By using the fine-tuning equipment and oscillator C, an accuracy of 2 parts in 10^8 may be obtained. For convenience in checking and higher accuracy, oscillator C may be monitored at the fourth harmonic using the same interpolation range and equipment as used for monitoring oscillator A. The outputs will remain constant in frequency to these stated accuracies for several minutes when using the adjustable oscillators, and the interpolation equipment allows continuous determination of frequency over longer periods of time.

c. Frequency-Measurement Equipment

The equipment for measuring the frequencies of oscillators A, B, and C is of conventional type. Briefly, an audio-frequency interpolation oscillator is used to measure the frequency difference between the oscillator's output and harmonic check points derived from the primary-standard frequency. A harmonic series generator and level mixing unit supplies harmonics of 100 kc/s and 10 kc/s, derived from the primary standard, combined with the adjustable oscillator's output, into a radio receiver tuned to the oscillator frequency. When properly tuned and adjusted, the output of the receiver will contain a beat note of between 0 and 5,000 c/s, which is compared directly on an oscilloscope with the output of the interpolation oscillator covering a 0 to 5,000 c/s range and having a linear calibration. When properly adjusted this oscillator has an accuracy of ± 1 c/s throughout its entire range, thus the frequency of the unknown oscillator may be determined within ± 1 c/s, or approximately 1 part in 2 million for any one of the three oscillators. If higher accuracy is required in determining the frequency of the adjustable oscillator, its frequency may be measured at a harmonic, with a proportionate gain in measurement accuracy. This, however, is not justified, except where continuous monitoring is employed, as the short-time stability of the oscillator (3 minutes) is only of the order of 1 part in 2 million. Beats very near to 0 may be conveniently checked at a harmonic in this manner, or, if still too low, may be counted.

d. Harmonic Generating and Detection Equipment

The final output of the multipliers at points D, E, and F is impressed across a silicon-crystal rectifier of appropriate type in order to generate harmonics in the microwave bands. These rectifiers are installed in the standard coaxial mounts or mixers at frequencies up to about 3,000 Mc/s and in waveguide mounts at higher frequencies. Various arrangements can be used. Mixers, such as Radiation Laboratory type TPX-35GM and TPK-23KL, are satisfactory as harmonic generators. Frequencies thus obtained in the coaxial or waveguide transmission system constitute the frequency standards and are utilized in the measurement of unknown frequencies or calibration of frequency meters.

The frequency range covered by these harmonics is shown in Fig. 2. Harmonics of the 85.5 to 92.7 Mc/s output overlap in range from about 1000 Mc/s up, those of the 256.5 to 278.1 Mc/s output overlap from 3200 Mc/s up, and those of the 769.5 to 834.3 Mc/s output overlap from 9200 Mc/s up. When a choice of multiplier output is possible, the higher output frequency will, of course, utilize the lowest order of harmonic and give the highest microwave output in the desired range. The directly-derived fixed-frequency outputs, which occur at approximately 1% intervals throughout the spectrum, divide each harmonic range shown into eight equally spaced parts, the frequencies being accurate to 1 part in 10^8 or better. The order of harmonic being used is, in each case, checked by use of a previously calibrated frequency meter; or, if one is not available within the range, by the agreement of two separate measurements using different harmonics in each case.

Although the microwave power derived from the harmonic generators is low, by the use of sensitive radio receivers or spectrum analyzers, calibrations and frequency measurements may be made. Ordinarily, the calibrating and unknown frequencies are fed into the spectrum analyzer and the standard frequency adjusted until the indicated pips on the screen of the spectrum analyzer coincide. An unknown oscillator of sufficient constancy may be accurately measured by heterodyning with a standard fixed frequency.

To determine the resonance frequency of cavity-type frequency meters a similar procedure may be used in which the frequency of an external oscillator set at the resonance frequency of the cavity is determined by comparison with the standard. Or, alternatively, the standard frequency itself may be used to excite the cavity and adjusted until a maximum or minimum is seen on the spectrum analyzer, depending on whether a transmission-type or reaction-type cavity is being measured. With the addition of a frequency of approximately $f_0/2Q$ fed into the harmonic-generator crystal at proper amplitude along with the standard frequency, so as to give a side-band frequency on each side of the cavity resonance curve at about the half-power point, an improvement of from 2 to 5 times in accuracy of calibration may be obtained. Resonance is then indicated when the standard frequency is adjusted to give equal amplitudes on each side-band pip. When using this method, however, it is important that the response of the overall analyzer equipment following the frequency meter be flat. Operating near the edge of an oscillator "mode" and critical matching stub adjustments should be avoided.

Superheterodyne search receivers with panoramic adapters are available for calibration and measurement work over the range from 300 to 3000 Mc/s. In addition, spectrum-analyzer equipment is readily available with detection equipment covering the ranges of 2,400 to 3,750 Mc/s, 5,200 to 8,000 Mc/s, 8,400 to 10,000 Mc/s, and 21,500 to 26,400 Mc/s. Accordingly, even though the frequency standard has complete and continuous coverage, it is at present somewhat more difficult to make frequency measurements of unknown frequency meters outside the above ranges. Additional plumbing and local oscillator equipment is being made available so that complete coverage of the entire microwave spectrum may be conveniently handled. Multiple conversion, measurement of harmonics, and beat-frequency measurements without spectrum analyzers are other methods which may be utilized.

A spectrum analyzer (Radiation Laboratory type) with plumbing covering the range 3,400 to 10,000 Mc/s approximately, with crystal harmonic generator and unknown and calibrated frequency meters in position is shown in Fig. 7.

Complete coverage of the range from about 300 to 100 Mc/s is obtained by feeding the output from the 28.5 to 30.9 Mc/s multiplier through a harmonic generator of the coaxial type. Also, by the use of the converter-stage outputs on the fine-tuning unit, complete coverage of the lower frequencies from audio frequencies up to 300 Mc/s may be obtained.

5. Accuracy of Calibrations

a. Unknown Oscillator Frequencies

The limit of accuracy with which the frequency of an unknown oscillator can be measured is the absolute accuracy to which the standard frequency itself is known, or as previously stated, to 1 part in 10^8 . (Frequency inter-comparisons between the various primary-standard oscillators are regularly made to 1 part in 10^{10}). Using the regular equipment with oscillators A or B, a maximum accuracy of 1 part in 10^7 may be achieved if the frequency of the unknown is sufficiently constant. When using the spot-frequency or fine-tuning equipment 1 or 2 parts in 10^8 are the approximate limits of accuracy.

After reaching operating temperature, when using oscillator combinations A and B, or C, the constancies of these oscillators are such that accuracies of the output frequencies of 1 part in 10^7 and 2 parts in 10^8 , respectively, may be maintained over a three-minute period without adjustment. For most microwave oscillators, this constancy is considerably better than that of the frequency being measured.

b. Frequency Meter Calibrations

The accuracy certified in calibration of a frequency meter depends on constancy of the meter, its Q and on the sensitivity of the resonance-indicating device. The useful accuracy of the calibration also depends upon the sensitivity of the method followed to set on resonance in use, and on whether or not the reactance coupled into the cavity by the external circuits is the same as that when the calibration was made. To reduce frequency pulling, due to coupled reactance, calibrations are usually made with matched attenuators having enough attenuation to effectively isolate the frequency meter.

For cavity-type frequency meters, sealed against humidity changes and either temperature-compensated or made of invar, the effects of humidity and temperature can be greatly reduced. For unsealed cavities, calibration in the controlled standards room greatly improves the accuracy of calibration, but use of the cavity under conditions other than standard will involve additional errors even though corrections are made. These arise because of errors in the measurements of temperature and humidity, failure of the cavity to come to equilibrium, and errors in the correction data to be applied.

The accuracy of tunable-type cavity frequency meters is also limited by backlash and dial inaccuracies and by the fact that these meters are seldom of the sealed type.

The accuracy of calibration of a cavity frequency meter depends on how closely it can be set to resonance. Since it resonates over a finite bandwidth determined by its loaded Q_L , the accuracy of calibration will be a function of the Q of the cavity. This can be determined by calculating the sensitivity of setting the cavity to resonance in terms of the smallest change in output response which can be seen on the output indicator used for determining resonance. If the output indicator is a spectrum analyzer, the height of response on the oscilloscope will be proportional to the r-f input power to the analyzer; this dependence is brought about by proper design of the second detector circuit and is done in order to show an energy spectrum on the oscilloscope. This increases the sensitivity of setting a cavity to resonance compared to that obtained with a receiver having output proportional to input voltage.

The height of response on a spectrum analyzer can be calculated from the equivalent circuit shown below, where there is also shown a curve of response versus frequency.

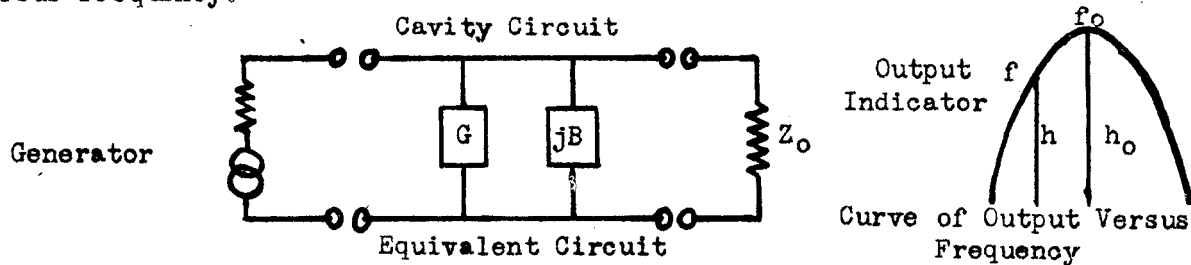

This equivalent circuit is derived from cavity theory for a symmetrical cavity and shows the cavity as a parallel resonant circuit having conductance G and susceptance B . The equivalent constant voltage generator transmits power to the matched output load Z_0 . The ratio of power transmitted off resonance, P , to that transmitted on resonance P_0 , will be equal to the ratio of response off resonance, h , to that on resonance, h_0 . This can be shown to be given by the following formula,

$$\frac{h}{h_0} = \frac{P}{P_0} = \frac{1}{1 + 4 \frac{Q_L^2 \Delta f^2}{f_0^2}}$$

where $\Delta f = f_0 - f$. The fractional uncertainty in setting to resonance is given from this formula as

$$\frac{\Delta f}{f_0} = \frac{1}{2Q_L} \sqrt{\frac{\Delta h}{h_0}}$$

when $\Delta h \ll h_0$ as is the case for the Naval Q_L values encountered. Here $\Delta h = h_0 - h$ and is the smallest change in response that can be determined on the output indicator. For a cavity having a loaded Q_L of 10,000 and $\Delta h/h_0 = 1/25$ this equation gives $\Delta f/f_0$ as one part in 100,000. Actual tests show that this is the order of accuracy of setting obtainable with present-day spectrum analyzers when trying to set to the maximum of the response curve where the slope is zero. By careful work, accuracies somewhat better than this can be obtained. However, when much greater sensitivities for setting to resonance are needed, it is necessary to use other

methods, some of which work on the steep sides of the resonance curves, such as the method described under 3-d. A cavity Q meter employing such methods gives sensitivities several times greater than that obtained by setting at the peak of the resonance curve. Increased sensitivity would also be obtained by sharpening the response curve by means of circuits for which the output response of the spectrum analyzer goes up faster than the case where it is proportional to the input power.

c. Q Measurements

An accurate measurement of the loaded Q of transmission-type frequency meters, or other symmetric transmission-type components, may be made by measuring the frequencies at which the power transmission drops to 0.5 of the resonance-frequency power. The Q then equals $f_0/(f_2-f_1)$. For high Q components the limit of accuracy using this method is determined by the precision to which the 0.5 power points can be set. A conservative estimate that these points can be set to $\pm 2\%$ of the f_0 maximum response value (which is approximately a $\pm 3\%$ variation in amplitude at the half-power points) would result in a maximum error of about 4% in the f_2-f_1 value, as the voltage response is very nearly inversely proportional to the number of cycles off resonance in the half-power regions. This would give a similar 4% maximum uncertainty in the Q value caused by limitations in determining the half-power points and should constitute the principal error in such Q measurements. This can be seen by solving the equation given above for Q from which we have

$$Q_L = \frac{f_0}{2\Delta f} \sqrt{\frac{h_0 - h}{h}}$$

where $h = 1/2 h_0$ at the half power point.

For measuring the Q of reaction type cavities it is usually necessary to terminate the line with the cavity and to measure the standing wave ratio, with a slotted line, as a function of frequency. This curve can be plotted and Δf determined as the distance between points on the curve where the standing wave ratio is given by

$$\frac{r_0 + 1 + \sqrt{r_0^2 + 1}}{r_0 + 1 - \sqrt{r_0^2 + 1}} \quad \text{where } r_0 \text{ is the stand-}$$

ing wave ratio at resonance. The loaded Q_L is then $f_0/\Delta f$.

Components having low Q values (less than several thousand) cannot be reliably measured directly by using the microwave frequency standard as a source of excitation, since the Q of the multiplier circuits and the matching components in the crystal multiplier assemblies is fairly high and the mixer and local oscillator plumbing may also be fairly frequency-sensitive. When low Q values are to be determined, a local oscillator with constant output over the range to be explored should be coupled directly to the component to be measured and a detecting system of linear or known response used to set the half-power points. This oscillator is then measured by comparison with the microwave frequency standard. With this method the accuracy of Q measurements is usually limited by the precision with which the half-power points can be set and the constancy of output maintained by the oscillator over the range used.

d. Dependence of Resonance Frequency on Temperature for Cavities without Temperature Compensation

Since the resonance frequency of a cavity is a function of its linear dimensions, and since these vary with temperature, the calibration of a frequency meter requires a specification of its temperature at the time of measurement. From the principle of electrodynamic similitude it follows for a perfectly conducting cavity that regardless of the type of mode or shape if all linear dimensions be varied proportionately, then the reciprocal of the frequency will vary in the same proportion. In general, for cavities of finite conductivity, neglecting second-order effects,

$$\frac{\Delta l}{l} = - \frac{\Delta f}{f} = \alpha (T - T_0)$$

where $\frac{\Delta l}{l}$ represents the fractional increase in linear dimension, and is

the thermal coefficient of expansion for the material from which the cavity is made, assuming this is homogeneous. Since the temperature of the cavity in general will be uniform within 0.1° C, and may be specified at the time of calibration to that figure, the fractional error in frequency of calibration due to the uncertainty in the temperature is, under these conditions,

$$\frac{\Delta f}{f} = - \frac{\alpha}{10}$$

The expansion coefficient α is the increase in length per unit length per degree Centigrade and has values of 0.9×10^{-6} , 9.6×10^{-6} , 19.0×10^{-6} , for invar, stainless steel, and brass, respectively.

e. Dependence of Resonance Frequency on Humidity

The resonance frequency of a cavity is also a function of the dielectric constant of the medium it encloses. For perfectly conducting cavities, regardless of shape or mode, it follows from the principle of electrodynamic similitude, that, all other factors remaining constant, a fractional increase

in dielectric constant, $\frac{\Delta \epsilon}{\epsilon}$, produces a fractional decrease in frequency

given by $\frac{\Delta f}{f} = - \frac{\Delta \epsilon}{2\epsilon}$.

The dielectric constant of the air within a cavity is a function of the partial pressures of dry air and water vapor, and the temperature, or what is equivalent, the relative humidity. Report 599, entitled "Standards for microwave frequencies," issued by the Radiation Laboratory, discusses the effect of relative humidity on resonance frequency of cavities, and gives graphs of the dielectric constant of air over varying conditions. Report 599 includes a nomograph giving the change in frequency of a resonant cavity due to changes in the relative humidity.

Unsealed or semi-sealed cavities may be subject to additional errors due to mode-damping materials. Some materials such as poly-iron used for mode-damping are hygroscopic and in giving up moisture will keep the atmosphere in the cavity at a higher relative humidity than that of the outside controlled atmosphere. Since the amount of moisture in the material is unknown and depends upon the previous history of the cavity, the cavity should be thoroughly flushed out with the controlled atmosphere and allowed to stand for several days under controlled conditions until equilibrium is reached.

The accuracy with which calibrations of cavities can be made can be summed up by stating that commercial cavities with a Q of about 10,000 have been measured with an accuracy of 1 part in 50,000 to 200,000 or better depending on whether the cavity was sealed or not. A sealed and compensated cavity might be calibrated much more closely by using more sensitive methods of setting on resonance. Adjustable cavities might not warrant such close calibrations because of mechanical inaccuracies of the tuning and dial arrangement.

6. Calibration Service of the National Bureau of Standards

The services of the Central Radio Propagation Laboratory of NBS, in connection with frequency standards, include measurements, tests and information on instruments which are in turn used as standards to test or measure considerable numbers of other instruments.

The frequency standards services are available without charge to the Army, Navy, and other Government agencies. The Army and Navy may arrange that similar services be supplied, without charge, to industrial concerns that need such services directly in connection with Army or Navy contracts. Frequency standardization tests are available to the public, with fees charged in accordance with the normal NBS policy.

All requests for tests of oscillators or frequency meters in the range above 300 Mc/s should be made in writing to the Director, National Bureau of Standards, Attention Central Radio Propagation Laboratory, Division XIV, Section 9, and should state the frequency or frequencies to be covered, method of coupling, and any special limitations or operating conditions desired for the test. Calibrations will normally be made at room conditions of 25° C and 50-percent relative humidity.

All requests for tests for contractors for Army or Navy should reach the NBS in writing via an inspection, liaison or other office of the Army or Navy.

Appendix

I. Operating Instructions

Efficient operation of the microwave frequency standard requires a knowledge of the relative advantages of the various possible combinations of equipments and auxiliaries. The location and proper use of the various controls and connecting circuits should also be understood.

Generally, a frequency of 100 kc/s will be supplied through the filtered line to the standard frequency jack at the top-left of the center rack. From this jack the signal is connected through the distribution amplifier to the various other equipments as shown in the block diagram. The use of external panel connections for all interconnecting leads is employed to obtain maximum flexibility and utility of the equipment. The 100 kc/s frequency supplied from one of the primary-standard oscillators, will normally be within 2 parts in 10^7 of true frequency. Where measurements requiring a higher order of accuracy are being made, the absolute value within 1 part in 10^8 should be obtained from the Frequency and Time Standards group of Section 8.

In making calibrations or measurements it is necessary to decide which units of the equipment should be used. Adjustable-type frequency meters may be most easily calibrated using the spot-frequency equipment to generate harmonics entirely controlled from the primary standard, unless it is necessary that calibrations be made at certain specific frequencies. Fixed-type frequency meters must be calibrated by use of the adjustable oscillator and interpolation equipment. The fine-tuning adjustable oscillator should be used only where extremely accurate measurements or maintenance of a constant frequency over a long period are desired, since it involves the use of several added controls and additional steps in the computations.

Because of the high accuracy and wide coverage of the microwave frequency standard, it is a rather complicated instrument. Preliminary searching or exploration of unknown equipment frequency characteristics is most easily accomplished by use of an auxiliary oscillator of few controls.

1. Procedure for Making Calibrations Using Adjustable-Frequency Oscillators

Before using the adjustable oscillator equipment for highly accurate calibrations, the oscillators should be allowed to stabilize for one hour or more. The multiplier and converter equipment may be used without this warm-up period without loss of accuracy, but the tuning of some of the high Q circuits may have to be readjusted periodically until temperature stabilization occurs. The a-c power to the entire three-rack installation is controlled by one of the breaker switches on the distribution box and each rack's entire equipment is controlled from the toggle switch on the right side of the top panel of each rack.

The approximate microwave frequency required for calibration or measurement will already be known or should be determined by use of a search oscillator or by other means. A convenient method for doing this, where a frequency meter to be calibrated lies within the range of a spectrum analyzer, is to couple the meter closely to the analyzer input and observe the reaction pip on the local-oscillator "mode" curve. By matching this pip with one from a calibrated frequency meter a fairly accurate preliminary calibration may be made. For adjustable frequency meters the approximate end limits of frequency should be determined and the desired calibration points between these limits selected.

After determining the desired approximate frequency, the harmonic range chart (Fig. 2) should be examined and the highest output range selected which will give harmonics at the desired frequencies. If continuous coverage is

desired over greater than an 8% frequency range, harmonics of the 12th order and higher must be used. The use of the highest output range (and lowest harmonic order) gives the greatest amount of microwave power and requires the use of less gain in the spectrum analyzer. This reduces the amount of amplitude instability or jumpiness of the pip on the analyzer screen and the amount of "stub twiddling" or matching required to get a usable signal. The required frequency at a given output jack is divided by the proper multiple of 3 to get the approximate frequency at the 9.5 to 10.3 Mc/s output of the converter stage. The required adjustable oscillator frequency is obtained by subtracting 7.5 Mc/s; the correct dial setting for the oscillator is obtained from the calibration chart or from one of the frequency graphs.

Working upward from the converter stage, the microwave output frequency is,

$$F_m = (7.5 \text{ Mc} + F_{osc}) AB$$

where A = 9 for the 90 Mc range; 27 for the 270 Mc range; 81 for the 810 Mc range

B = harmonic multiplication order of the crystal multiplier

Calibration charts are supplied for the 2.0 to 2.4 Mc/s and 2.4 to 2.8 Mc/s oscillators which give the dial setting for each even 10-kc point throughout their ranges. These dial settings may normally be relied upon to be within ± 1 dial division or approximately ± 50 c/s. Dial settings for frequencies between these points are obtained by interpolation, or with greater ease and accuracy by the use of the interpolation equipment used to measure the final frequency. Charts giving the microwave frequency outputs from harmonics of the 30, 90, 270, 810 Mc/s output stages with adjustable oscillator inputs of 2000 to 2800 kc/s at each 100 kc/s interval within this range are also available. It is necessary to determine the harmonic multiplication order of the crystal multiplier to compute the microwave frequency being measured. These harmonics are usually identified by use of a previously calibrated frequency meter having sufficient accuracy to unmistakably identify the harmonic being used. In the event that no calibrated frequency meter is available in the range being used, several successive harmonics may be used to obtain the desired microwave frequency. It is best to use at least three separate input frequencies to give these harmonic responses and through knowledge of the input frequencies determine the harmonic order for each input frequency. If only two frequencies are used it is sometimes possible to select harmonics that are not adjacent, but may be assumed so, thus giving an erroneous result. This may be more likely to occur if the measured microwave frequency range is not approximately known, but is very unlikely to occur if three separate harmonics are used.

2. Measurement of Adjustable-Oscillator Frequencies

The adjustable oscillator frequencies are measured directly in terms of the primary standard of frequency by comparison with frequencies or harmonics derived from the standard. A harmonic series generator is used to generate harmonics of 100 kc/s and 10 kc/s throughout the 550 kc to 30 Mc/s range of the receiver. Only the frequency range of 2.0 to 2.8 Mc is used in measuring the adjustable oscillator frequencies. The 500 to

600 kc/s oscillator, used with the fine-tuning arrangement, is measured on the fourth harmonic and the resulting frequency divided by four to obtain the greater accuracy which is desirable when this oscillator is used.

The resulting beat note from the receiver between the adjustable oscillator and the 10 kc/s standard-frequency markers is measured by means of the audio-frequency interpolation oscillator and comparison oscilloscope. This oscillator (G.R. type 617-C) has a frequency range of 0 to 5000 c/s and, when checked against the 100 c/s from the standard-controlled frequency divider at 100 cycle intervals, has an accuracy of ± 1 c/s throughout its range. The approximate frequency of the adjustable oscillator is determined from the dial calibration and the observed beat frequency added to, or subtracted from, the proper 10 kc/s multiple to get the exact oscillator frequency. Where the beat note is either very near 0 or 5000 c/s, a slight adjustment of the oscillator dial after the beat frequency has been noted, and observation of the direction of change will determine if the beat frequency should be added or subtracted. By using the crystal filter on the receiver and proper tuning, frequencies up to 5000 c/s may be measured. Beat frequencies too near to zero beat to be measured on the oscilloscope may be measured at a higher frequency on the receiver or counted.

The harmonic series generator panel includes mixer controls by which the relative strengths of the standard and unknown signals may be adjusted for maximum beat frequency output. Fixed insertion-type attenuators are also provided for a rough control of these output levels..

In similar manner the receiver and interpolation equipment may be used to measure the frequency of any signal in the frequency range of from 0 to 30 Mc/s.

3. Use of Fine-tuning and Spot-Frequency Equipment

The fine-tuning arrangement makes use of the outputs from the 500 to 600 kc/s oscillator, the decade frequency generator, and the frequency multiplier and dual-frequency converter to give a highly accurate, precisely controlled, continuous coverage of the frequency range of 2.0 to 2.8 Mc/s. This output is supplied to the main frequency converter in place of the adjustable oscillator outputs of 2.0 to 2.8 Mc/s to give very fine tuning control and much higher stability for critical measurement applications in the microwave frequency band. Normally, the multiplier stage or the first converter stage will be used to generate multiples of 100 kc/s of from 1500 to 2200 kc/s, obtained by multiplying or mixing outputs from the decade frequency generator. To these respective frequencies the 500 to 600 kc/s from the oscillator is added, through use of the second converter stage. The oscillator should always be patched into the right-hand input jack on the converter stages to reduce harmonic interference or spurious frequencies in the output. These spurious frequencies are caused by harmonic distortion of the oscillator frequency in the converter tube and, when these harmonics fall near the desired output frequency, may be of sufficient amplitude to be bothersome under certain conditions. If such interference occurs, the other side-band or difference frequency may be used in some cases to obtain the same output frequency, or the oscillator frequency may be injected at the first converter and a fixed frequency substituted at the second converter.

The latter method requires that one more tuning control be kept in step when adjusting the oscillator frequency. Spurious frequency responses are treated in detail under section 4-C. When using the converter stages for multiplication only or for mixing frequencies entirely derived from the standard, no harmonic side-frequencies are generated.

Fixed frequencies at 100 kc/s intervals in the frequency range 2.0 to 2.8 Mc/s are generated by multiplying or combining in the converters the outputs from the decade frequency generator. Several combinations are possible for many of the frequencies and, since no harmonic-generated side frequencies are present, any readily obtained combination may be used. The microwave outputs, when using these frequencies, are most useful for calibrating tunable frequency meters or for supplying marker frequencies in any portion of the microwave spectrum.

4. Operating Technique and Precautions in Use of Equipment

a. Frequency Standard

In using the microwave frequency standard, the desired oscillator units should be turned on and stabilized and the proper interconnections completed. The meter on the 100 to 7500 kc/s multiplier should be adjusted to read at one-half scale when the meter switch is in the left-hand position by means of the level control on the 100 kc/s distribution amplifier. This meter also serves as a convenient indication that the 100 kc/s is being supplied when starting up the equipment. Lamp loads are available for the various output jacks and power levels and serve as convenient relative-power-output indicators when tuning up or adjusting the various circuits.

Tuning of the various stages should progress from the lowest-frequency stage on up through the various mixers and multipliers to the output stage. Meters are available on each tunable stage for adjusting to resonance. These meters give no indication of the power output; in most cases they show conditions of maximum radio-frequency current. Plate-current meters are also provided for the 90, 270, and 810 Mc/s multiplier output stages, but since the multiplier efficiency is low in these stages, these meters show slight indications of resonance and are chiefly useful for determining tube loading. The very low efficiency of the output stages makes the system practically fool-proof. Detuning of any of the stages or operation at minimum bias control settings will not overload the tubes. Considerable caution should be observed when using crystal multipliers on any of the outputs, that the crystal is not burned out from a sudden overload as the output stage is tuned up. Output levels for each of the three output stages are adjusted by means of a bias control for each stage. The excitation to the 90 Mc/s stage is so balanced that output from this stage may be controlled from 0 to approximately 2 watts. Output from each of the other stages is normally adjusted by means of this same 90 Mc/s control, the other bias controls being adjusted for optimum operation and left there. Filament switches are provided on the 270 and 810 Mc/s stages for turning these tubes off when not in use. A grid-range switch in the 810-Mc untuned input must also be thrown to the proper position when using the 270 or 810-Mc stages.

The practice of turning off all of the equipment except the oscillators for standby periods of several hours or greater will save considerably on tube replacements. The considerable reduction in heating also reduces the load on the air-conditioning unit during such periods.

b. Crystal Multipliers

The use of silicon-crystal rectifiers of the series IN21, IN23, IN26, or other types to generate high harmonics from the standard frequency outputs at 30, 90, 270, and 810 Mc/s simplifies considerably the measurement of microwave frequencies. These rectifiers, however, have certain limitations which must be considered when used in this manner. Since the power output on any particular harmonic is very low (the order of microwatts) it is necessary to work the crystal rectifier at very nearly the maximum power input it will stand under continuous operation. This power is of the order of 0.1 to 0.5 watt depending on the type and condition of the crystal being used. Crystal input impedances generally range from 100 to 500 ohms.

The optimum excitation is readily apparent for any particular harmonic if the output is observed on the spectrum analyzer oscilloscope. Increasing power input beyond the optimum point will result in rapid loss of output which will drop to zero at possibly twice the optimum input power. If a meter is connected so as to read rectified crystal current, its reading will be maximum when the greatest harmonic power is being generated. This decrease in output current or rectification efficiency under overloaded conditions is generally attributed to a reduction of the reverse resistance of the crystal. Maximum current will generally be of the order of 20 to 50 milliamperes. The use of an indicating meter gives a convenient means of adjusting for maximum harmonic output and also serves to show, to some extent, the condition of the crystal. Operation at, or very near the point of maximum harmonic power output reduces considerably the tendency toward jumpiness of the received signal on the oscilloscope. However, operation of a crystal rectifier at input above the maximum current or harmonic output point for any considerable period of time will result in loss of sensitivity or burn-out of the crystal.

In the wave-guide mounts where the base of the crystal is clamped at one side of the wave guide, an insulated connection may be installed for use in operating a rectified-current meter. A button condenser is useful in making the outlet a low impedance to microwave power. By use of a variable resistor in the meter circuit, a rectified negative bias can be used on the crystal which may improve the generation of harmonics by as much as 6 db in some cases. This reduces the power dissipation in the crystal but increases the reverse voltage applied. The use of some of the newer types of high-back voltage crystals such as welded germanium crystals may increase considerably the amount of microwave power output. On the other types of crystal mounts, some form of shunt feed on the center conductor of the radio-frequency input cable can be used to obtain the connection point for crystal-current meter and bias control.

By means of the crystal current tap or through a regular coaxial T connection, an additional frequency may be injected into the crystal multiplier to give side bands on both sides of every harmonic of the multiplier output. These side bands are useful as additional marker frequencies and as a means of higher accuracy in the calibration of frequency meters, if the side bands are generated at approximately the half-power points. Undesired spurious sidebands and responses and some of their causes are discussed in section c below under "spurious frequencies".

In tuning up the multiplier it is best to adjust the bias control to give low output, maximize each of the tuned stages, including the final output stage and then maximize the harmonic output by adjustment of the 90 Mc bias control. This insures that each radio-frequency stage is tuned properly and has not been falsely detuned to show maximum harmonic output because the crystal had been overloaded at resonance.

The use of "line stretchers", matching transformers, etc., in the line feeding the crystal multiplier is usually not necessary, except perhaps at the 810-Mc input frequency. Since the crystal impedance is generally several times as high as that of the line, standing waves will develop. By having adequate reserve power the optimum crystal excitation may still be maintained. In the 810-Mc stage the use of a line stretcher of six to eight inches variation may prove helpful.

c. Spurious Frequencies

Spurious or undesired frequencies in the outputs from the crystal multipliers are introduced from several sources which will be discussed separately. It should be noted that spurious frequencies slightly separated from the desired driving frequency and 30 to 40 db down in level, may, when passed through the crystal multiplier, come out at equal amplitude with the desired harmonics or in some cases even completely obscure the desired frequency. Proper converter adjustment, reducing these interfering frequencies by 50 to 60 db in the range where harmonic interference develops and careful tuning of the other stages will reduce these interferences to a satisfactory level.

(1) Multiplier Side-Frequencies

Side-frequencies are generated in the frequency-multiplier stages which consist of adjacent harmonics to the desired harmonic output. These adjacent harmonics appear in the output with a ratio to the desired frequency which is determined by the relative harmonic content generated and by the selectivity of the output tank or filter employed. The higher the harmonic order, the more difficult it becomes to separate a given harmonic from the adjacent ones, as the per cent of separation becomes increasingly less. Where multi-stage frequency multipliers are used, these side-frequencies have a tendency to ride on through successive stages, giving side-frequencies in the outputs which are spaced the original side-frequency difference from the desired output as well as harmonics of this difference. The side-frequencies may or may not be symmetrically located around the desired frequency and certain of these frequencies may be missing or very highly attenuated.

It is obvious that, where these side-frequencies prove bothersome, the logical place to reduce them is in the stages where they are generated in each case. The use of several separately tuned circuits, loosely coupled, or a multi-section conventional filter is usually sufficient to reduce the amplitude of such responses to a satisfactory point. Such filter networks will be noted in the detailed circuit schematics of the various multiplier and converter units. Crystal filters are also useful when the separation is small (less than about 10%) but must usually be used in conjunction with the conventional networks.

In using the output from one of the multiplier stages to drive a crystal multiplier to obtain high harmonics for microwave frequency measurements it is possible to obtain responses from other than the desired source frequency. This is most likely to occur if the output stage driving the crystal multiplier is greatly detuned, but might occur through considerable detuning of an earlier stage. Usually these responses are of greatly reduced amplitude and are eliminated by proper tuning. They are more likely to occur when using the 270 to 810-Mc stages, where the 30 and 90-Mc side-frequencies are separated by a smaller percentage of the operating frequency. Sufficient filtering has been employed in all but the high-level output stages to reduce these spurious frequencies to a negligible amount.

(2) Converter-Generated Harmonic Interference

This type of interference is caused where a harmonic of one of the frequencies of a converter stage beats with one of the other frequencies, giving a heterodyne whistle in the output as the tuning is varied. Higher harmonics of both mixed signals in a converter may at times give difference frequencies which are near the desired sum or difference frequency and introduce a spurious beat, or sideband frequency in the desired output.

A specific example of this type of interference occurs in the main frequency converter when the 7.5 Mc/s and approximately 2.5 Mc/s from the adjustable oscillator are added to obtain frequencies in the region of 10 Mc/s. If the oscillator is set on 2510 kc/s, the desired output frequency will be 10,010 kc/s. The fourth harmonic of the 2510 kc/s is 10,040 kc/s and this frequency will also appear in the output of the converter. The amplitude of this interfering frequency depends upon how far it deviates from the resonance frequency of the plate filter network and upon the type and operating conditions of the frequency converter. For a given converter output band-width, the higher harmonic orders (larger ratio between the two mixed frequencies) would cause less interference but would require a greater oscillator tuning range and might give several harmonic cross-over points. Push-push or push-pull converter circuit arrangements may be utilized to reduce the even or odd harmonic responses, but it seems very difficult to obtain both results with a given arrangement.

The main converter unit uses a balanced circuit arrangement to attenuate the even harmonic responses as the fourth harmonic of the lower mixed frequency is the only one which falls within the operating range. Needless to say, the mixed frequency itself should be very free of such interfering harmonics; the interfering frequencies are then only those generated by the

non-linear operations of the converter element. A balancing resistor is used in the screen circuit of the two converter tubes to minimize the harmonic interference. Because of stray coupling and phase changes with tuning, complete cancellation does not occur but a definite adjustment minimum is obtained. An additional front-panel control is available for adjusting the oscillator input power when working in the 10-Mc output range of the converter. By this means satisfactory operation is maintained throughout the interfering range; this control may be operated at maximum throughout the remainder of the frequency range. Improper operation in the interfering range is immediately apparent when using a spectrum analyzer on the crystal-multiplied output by the appearance of a number of pipes on the screen very close to the desired signal. In some cases of improper adjustment the desired signal will be completely absent, with a band of spurious frequencies or "grass" on each side of the desired frequency. Reduction of oscillator input will allow the correct signal to come through and will reduce or eliminate the interference. Slight adjustment of the converter tuning control will often improve a signal which shows slight interference. When properly adjusted, the ratio of harmonic-generated interference to desired output at the 30-Mc jack is of the order of - 50 to - 60 db. When misadjusted, through unbalanced screen resistor or unbalanced converter tubes, or through too high an input power of the adjustable oscillator frequency, a ratio of approximately - 40 db or lower may result in unusable frequency output in the microwave region.

In the frequency multiplier and dual frequency converter a somewhat different method is used to reduce the harmonic-generated interference. These units cover a wider range of frequencies so that both even and odd harmonic frequencies would appear in the output. As single-ended converters of the tunable type are of much simpler design, these were employed. An advantage of desired frequency to harmonic interference of 55 to 80 db was obtained (depending on the interfering harmonic order) by using 6AC7 tubes as converters at very low efficiency. The harmonic-producing frequency is applied to the cathode at very low level with the other frequency applied at class C level to the control grid. In this manner a completely usable output is obtained by following the converter stage with sufficient power amplification. Should interference develop, the flexibility of the cable connections and the number of possible frequency combinations allow a harmonic-free operating point to be chosen.

(3) Parasitic Oscillations

Spurious frequencies of this type should not be present in any of the equipment when operating normally. Aging of components, increased secondary emission, or changes in tube characteristics which sometimes occur, might cause oscillations of this type to develop. Such oscillation is often of the forced type and is not evident when tuning by meters or bulb loads. However, if observed on a spectrum analyzer, such oscillation is immediately apparent as a heavy "grass" or noise on the base line with no central signal. If listened to on a receiver, the signal will tune broadly and have a very high noise level. Installation of a new tube or proper circuit adjustment should eliminate any such condition. A troublesome two-state oscillation between the 90 and 270-Mc states was eliminated by insulating the three-stage shield cover at the 90-Mc end, which proved to be a source of common coupling.

(4) Spectrum Analyzer Responses

The various spectrum analyzer differentiating circuits introduce pips on the analyzer screens. By proper positioning of the various switches and controls on the analyzer, these pips can be reduced or placed out of the working range to avoid confusion with the desired responses. When in doubt as to the source of such a signal, the standard frequency radio-frequency power may be cut off momentarily by the plate switch on the adjustable oscillator or decade frequency generator if used. If the pip disappears, it is identified as a harmonic of the standard frequency being supplied to the crystal multiplier.

d. Frequency Meters

In the calibration of frequency meters by use of a spectrum analyzer, a calibrated reaction-type frequency meter is generally coupled to the analyzer converter arrangement so as to obtain an approximate calibration of the local oscillator on the analyzer, and also to identify the harmonic order of the multiplied standard frequency. The frequency meter to be calibrated is then placed between this calibrated meter and the crystal frequency multiplier. Reaction-type frequency meters are coupled by use of a T connection in the coaxial line or waveguide, with an isolating, matched resistive attenuator placed on each side of the T to reduce reactive coupling to the frequency meter being calibrated. Transmission-type frequency meters are coupled directly into the line with similar use of matched attenuators on each side of the frequency meter. Fixed attenuators of 10 db each have proven generally satisfactory; adjustable attenuators are convenient but may introduce somewhat greater mismatching.

For a symmetrical transmission-type cavity frequency-meter, effects of mismatch on observed resonance frequency may be judged by means of the following formula -

$$\frac{\Delta f}{f} = \sqrt{T} \frac{r^2 - 1}{8Q_c r}$$

In this formula Δf is the magnitude of the maximum frequency shift corresponding to external loading of the cavity on one side (either input or output) by an impedance characterized by a voltage standing wave ratio r . f is the resonance frequency, Q_c is the Q of the cavity with matched loads on both input and output, and T is the ratio of power transmitted to power incident on the cavity at resonance. The maximum total frequency shift with mismatches on both input and output is the sum of the individual frequency shifts calculated by the above formula. The formula is a good approximation if Q_c is large and r is not much greater than unity. As a numerical example, let $r = 1.15$, $Q_c = 4000$, $T = 1/4$, $f = 10,000$ Mc. Then the maximum total frequency shift corresponding to a mismatch of $r = 1.15$ on both sides of the cavity is approximately 0.1 Mc.

When calibrating tunable transmission-type frequency meters it is necessary that both the frequency meter and the local oscillator on the analyzer be tuned very accurately to the frequency being used for calibration and that this frequency be adjusted to give a usable output. A great amount of

adjustment and searching can be avoided if a T connection is placed on each side of the frequency meter beyond the attenuators; a flexible piece of waveguide or coaxial line is then used to bypass the frequency meter and attenuators while the crystal multiplier, frequency standard, and local oscillator are adjusted. This connection is then broken at one end and this frequency meter tuned for maximum response. In this manner, transmission-type frequency meters are no more difficult to calibrate than those of the reaction-type.

When setting up a frequency meter for calibration, the unsealed type should be left disconnected for a sufficient time to stabilize humidity within the cavity. Also, the frequency meter should be mounted far enough away from the spectrum analyzer and other heat-generating equipment to allow the cavity to remain at the temperature of the calibrating room.

Care should be taken when varying the output frequency of the frequency standard that the output level remains constant or the frequency at which a maximum or minimum is measured will be in error.

e. Spectrum Analyzers

Spectrum analyzers of several types are available, but all are essentially high-gain receivers of the "panoramic" type with cathode-ray tubes as indicators. The local oscillator is frequency modulated by a saw-tooth frequency in synchronism with the sweep frequency of the oscilloscope tube, allowing one to observe the response of signals within the range covered. As no image rejection is employed ahead of the crystal frequency converter, an indication will appear when the local oscillator is either lower or higher than the received signal by an amount equal to the intermediate amplifier frequency. Most of the analyzers may be adjusted from zero sweep width to a value wide enough to show both responses as the local oscillator is swept. Provision is also made, through a video amplifier driven by rectified converter-crystal current variations, for observing the "mode" adjustments or sweep range of the klystron local oscillator. By matching pips on this curve, an approximate calibration of frequency meters may be made.

In calibration work, the klystron local oscillator is usually operated with a wide frequency swing during preliminary adjustment and then narrowed down for final observations. Greater effective gain is obtained when sweeping over a narrow range as this gives the resonant circuits in the intermediate-frequency amplifier more time to build up as the frequency is swept by the pass-band of the amplifier. The maximum resolution of an analyzer, or ability to differentiate between closely adjacent frequencies, is determined by the band-width of the i-f amplifier.

Fig. 7 shows a photograph of a spectrum analyzer, crystal multiplier, and frequency meters set up for calibration in the 8,500 to 10,000 Mc/s frequency range.

II. Detailed Unit Descriptions

The following detailed descriptions are given as an aid in maintaining the equipment. Voltage and current readings on the various tubes are not given as in frequency multipliers and radio frequency amplifiers these values vary widely with excitation, loading and bias adjustments. In no case is the maximum recommended value exceeded.

The entire installation is assembled in three heavy duty enclosed relay racks. Panels are standard 19-inch sizes for rack mounting. Connector cables and jacks are either General Radio coaxial type or Army-Navy type N. Each unit is individually fused and a-c power is supplied through a miniature motor-base type of connector. A master switch and plug fuses are also provided in each rack.

1. Frequency Multiplier; Output 7.5 Mc/s

a. Description

The purpose of this unit is to multiply the 100 kc/s from the primary frequency standard to 7500 kc/s, which is one of the input frequencies of the main converter-multiplier unit. The multiplier consists of two push-pull quintupler stages and one push-pull tripler stage, all using 6SJ7 tubes. It is necessary that the output frequency be very free of harmonics and multiplied side-frequencies in order to avoid generation of undesirable spurious components in the converter unit. The side frequencies are reduced in each multiplier stage by the use of multiple tuned filter transformers, very complete shielding, and decoupling networks. The 7.5-Mc frequency is also passed through an additional filter in the converter unit.

b. Operation and Service Instructions

The 100-kc input power should be adjusted by means of the left-hand control to give a meter reading of 200 to 300 microamperes with the meter switch in position one. The meter switch positions 1 to 6 provide relative readings of grid and cathode currents in each stage. Proper alignment may be checked by removing the cover plate on the rear edge of the chassis and adjusting condensers C_1 through C_7 for maximum grid current in each stage as alignment progresses. The output-stage trimmer, C_8 , should be adjusted for maximum output on an external indicator or for minimum cathode current with the switch in position six.

Operating characteristics are as follows:

Power input: 110 v., 60 c., at 50 watts

R-f input: 100 kc/s, 50 to 100 mw at 500 ohms

R-f outputs: 500, 2500, 7500 kc/s at 25 to 50 mw, 100 ohms

R-f output purity:

7500 kc/s	2500-kc side-frequencies	- 60 db
	other side-frequencies	- 80 db
	3rd harmonic	- 60 db
	other harmonics	- 80 db

2500 kc/s	500-kc side-frequencies	- 45 db
	100-kc side-frequencies	-100 db
	harmonics	- 60 db
500 kc/s	side-frequencies and harmonics	- 60 db

c. Parts List

Resistor and condenser values are given in the schematic diagram, Fig. 8.

Tuned transformer data are as follows:

- T-1 Input transformer, 100 kc/s
pri.: 150 turns No. 36 en. silk cov. wire wound between secondaries.
sec.: balanced winding No. 36 en. silk cov. wire with 1/4 inch between pies, total inductance 12 mh.
tuning condenser: dual ceramic-mounted, 125 μ uf max. each section, in parallel.
shield can: aluminum, 4" x 2" x 1 7/16".
- T-2 Output transformer, 500 kc/s
pri.: balanced winding 5/41 litz, 1/8 inch between pies, total inductance 0.92 mh.
sec.: 10 turns 7/41 litz, wound between primary sections.
tuning condenser: dual ceramic-mounted, 80 μ uf max. each section, in parallel.
shield can: aluminum, 4 1/8" x 2 3/8" x 2".
- T-3 Coupling filter, 500 kc/s
pri.: 5/41 litz, wound on powdered-iron cylindrical core 7/8" x 3/8", inductance 0.5 mh (no secondary)
tuning condenser: dual ceramic-mounted, 125 μ uf max. each section, in parallel.
shield can: aluminum, 4" x 2" x 1 7/16".
- T-4 Input transformer, 500 kc/s
pri.: 10 turns 7/41 litz, wound between secondaries.
sec.: balanced winding, 5/41 litz with 1/8" between pies, total inductance 1 mh.
tuning condenser: dual ceramic-mounted, 125 μ uf maximum.
shield can: aluminum, 4" x 2" x 1 7/16".
- T-5 Output transformer, 2500 kc/s
pri.: 66 turns, center-tapped, No. 26 en. wire on 1 inch bakelite form, total inductance 70 μ h.
sec.: 1 turn No. 26 en. wire on 1/2" form and centered inside primary winding.
tuning condenser: dual ceramic-mounted, 80 μ uf max. each section, in parallel.
shield can: aluminum, 4 1/8" x 2 3/8" x 2".

- T-6 Coupling filter, 2500 kc/s
pri.: 62 turns No. 36 en. silk cov. wire toroidally wound on powdered-iron core 1/2" x 1/2" with 3/16" dia. hole, inductance 90 μ h (no secondary).
tuning condenser: dual ceramic-mounted, 125 μ mf max. each section, in parallel.
shield can: aluminum, 4" x 2" x 1 7/16".
- T-7 Input transformer, 2500 kc/s
pri.: 2 turns 7/41 litz wound toroidally at center of balanced secondary.
sec.: 56 turns No. 36 en. silk cov. wire, center tapped, toroidally wound on powdered-iron core 1/2" x 1/2" with 3/16" dia. hole, inductance 80 μ h.
tuning condenser: dual ceramic-mounted, 125 μ mf max. each section, in series.
shield can: aluminum, 4" x 2" x 1 7/16".
- T-8 Output transformer, 7500 kc/s
pri.: 30 turns No. 26 en. wire, center-tapped, wound on 1-inch bakelite form, total inductance 20 μ h.
sec.: 1 turn No. 26 en. wire wound on 1/2 inch bakelite form and centered inside primary winding.
tuning condenser: dual ceramic-mounted, 80 μ mf max. each section, in parallel.
shield can: aluminum, 4 1/8" x 2 3/8" x 2".

d. Illustrations

- Fig. 8. Layout drawing of frequency multiplier;
100 to 7500 kc/s
Fig. 9. Circuit schematic of frequency multiplier;
100 to 7500 kc/s.
Fig. 10. Photograph of frequency multiplier;
100 to 7500 kc/s (top front view).
Fig. 11. Photograph of frequency multiplier;
100 to 7500 kc/s (bottom view).

2. Frequency Converter-Multiplier; Output 28.5 to 30.9 Mc/s

a. Description

This unit contains a balanced frequency converter stage, using 6SA7 tubes, which mixes 7500 kc/s derived from the primary standard of frequency and a very stable adjustable-oscillator frequency or other standard frequency. The resultant sum frequency, between 9.5 and 10.3 Mc/s, is passed through a tunable filter to a tripler stage using a 6AC7 tube. This stage is followed by a tuned amplifier stage using a 6SK7 tube and having a low impedance output which is used to drive the three-stage frequency multiplier. The tripler and amplifier tuning controls are ganged and tuning meters are provided for both the converter and tripler-amplifier stages.

b. Operation and Service Instructions

Operation of the unit is straightforward; the proper inputs are connected and the stages tuned for maximum meter response. The dial ranges are such that only the desired modulation product or harmonic falls within the tuning range in each case. The 7.5 Mc/s is passed through an additional filter and applied in push-pull to the converter grids. The 2.0 to 2.8 Mc/s is passed through an adjustable attenuator and then through a band-pass filter and applied to the grids in parallel. In this manner, harmonics of the lower input frequency which might be present in the input or generated in the tubes are greatly reduced, as the plates are connected in push-pull. This is an important consideration as the fourth harmonic of the adjustable oscillator, when operating in the range of 2500 kc/s, will cause interference with the desired frequency if it is allowed to get into the output circuit. Adjustment of the input to give just sufficient output to drive the next stage when operating in this region will reduce this interference to a negligible amount. An adjustable resistor in the screen circuit is provided on the chassis to allow balancing the converter tubes to reduce this interference; this control should be checked if the converter tubes are changed.

Alignment of the various circuits may be checked by connecting the proper input frequencies and adjusting the successive trimmer condensers for maximum meter response. These adjustments should be made at the high-frequency end of the band and checked for uniform response throughout the band, making slight readjustments if necessary. The 2.0 to 2.8-Mc band-pass input filter may be checked by removing one converter tube, substituting a vacuum-tube voltmeter between the No. 1 socket pin and chassis and aligning the trimmers for uniform response throughout the band.

Adjustment of the balancing resistor for reducing harmonic crossover interference is carried out by tuning the adjustable oscillator to 2.5 Mc/s and listening to the resulting 30-Mc output on the receiver. The oscillator is then adjusted to give a beat note of about 1000 c/s in the receiver. The 2.5-Mc input-level control is decreased to give just enough excitation for maximum output at 30 Mc/s and the screen balancing control is then adjusted for minimum audio output in the receiver.

Operating characteristics of the converter-multiplier unit are as follows:

- Power input: 110 v, 60 c at 50 watts.
- R-f input: 7.5 Mc/s and 2.0 to 2.8 Mc/s, 25 to 50 mw at 100 ohms.
- R-f output: 28.5 to 30.9 Mc/s, 1 watt at 100 ohms.
- R-f output purity:
 - higher order modulation components in operating band - 60 db
 - harmonic crossover interference at 30-Mc point - 55 db
 - harmonics of output - 45 db

c. Parts List

Resistor and condenser values are given in the schematic diagram, Fig. 13.

Tuned transformer data are as follows:

- T-1 60 turns No. 34 en. wire, toroidally wound on 1/2" x 1/2" powdered-iron core with 5/16" dia. hole. C-3, 1.5 to 15 μ pf, National Co. UM-15.
- T-2 pri.: 2 turns No. 28 en. wire toroidally wound.
sec.: 56 turns No. 34 en. wire, center-tapped, wound toroidally on 1/2" x 1/2" powdered-iron core with 3/16" dia. hole.
C-4: 1.5 to 15 μ pf, National Co. UM-15.
- T-3 pri.: 4 turns No. 28 en. silk cov. wire wound over secondary.
sec.: 56 turns No. 34 en. wire wound helically on 1/2" x 1/2" powdered-iron core.
ter: 56 turns No. 34 en. wire, center-tapped, helically wound on 1/2" x 1/2" powdered-iron core.
Spacing: between secondary and tertiary cores, 1/16 inch.
C-1 and C-2: 45 to 140 μ pf, mica compression-type dual trimmers, ceramic mounted.
- T-4 pri.: 32 turns, center-tapped, No. 34 en. wire toroidally wound on 1/4" x 1/2" powdered-iron core with 3/16" dia. hole.
sec.: 1 turn No. 28 en. wire toroidally wound.
C-5: 1.5 to 15 μ pf, National Co. UM-15.
C-6: 1.5 to 5 μ pf, National Co. UM-15 with two rotor plates removed.
- T-5 pri.: 1 turn No. 28 en. wire toroidally wound.
sec.: 32 turns No. 34 en. wire toroidally wound on 1/4" x 1/2" powdered-iron core with 3/16" dia. hole.
ter: 1 turn No. 28 en. wire toroidally wound.
C-7: 1.5 to 15 μ pf, National Co. UM-15.
C-8: 1.5 to 5 μ pf, National Co. UM-15 with two rotor plates removed.
- T-6 8 turns No. 28 en. wire on 1" x 2" low-loss bakelite form.
C-9: 1.5 to 15 μ pf, National Co. UM-15.
C-10: 1.5 to 5 μ pf, National Co. UM-15 with two rotor plates removed.
- T-7 pri.: 8 turns No. 28 en. wire on 1" x 2" low-loss bakelite form.
sec.: 1 turn No. 28 en. wire spaced 1/2" from low-impedance end of pri. winding.
C-11: 1.5 to 15 μ pf, National Co. UM-15.
C-12: 1.5 to 5 μ pf, National Co. UM-15, with two rotor plates removed.

d. Illustrations

Fig. 12. Layout drawing of frequency converter-multiplier; output 28.5 to 30.9 Mc/s.

Fig. 13. Circuit schematic of frequency converter-multiplier; output 28.5 to 30.9 Mc/s.

Fig. 14. Photograph of frequency converter-multiplier; output 28.5 to 30.9 Mc/s (top-front view).

Fig. 15. Photograph of frequency converter-multiplier; output 28.5 to 30.9 Mc/s (bottom view).

3. Adjustable-Frequency Oscillators; 2.0 to 2.4 Mc/s and 2.4 to 2.8 Mc/s

a. Description

The output from these oscillators is mixed with the primary-standard frequencies to give complete coverage of the multiplied frequencies in the microwave spectrum. The oscillators are Lampkin Laboratories type 103, to which have been added a highly filtered, regulated power supply and two radio-frequency output stages using band-pass plate transformers. Only the oscillator tube and its associated circuit are used in the Lampkin units, the other components being removed from the chassis. The 6AC7 amplifier tubes are operated class A to minimize harmonic interference in the converter stage. One of the stages is provided with output impedances of 50 and 500 ohms, either of which may be selected by means of a switch. A plate switch on the oscillator is also provided for momentarily turning off the radio-frequency output and still leaving the tubes in operating condition.

b. Operation and Service Instructions

The band-pass output transformers reduce the harmonic output and allow low impedance coupling to the converter stage. These double-tuned transformers are over-coupled and loaded so as to give essentially flat response throughout the operating band. Adjustment of the trimmer condensers is most easily carried out by using a 50-ohm resistive load and a vacuum-tube voltmeter on the output, setting the oscillator to 2080 kc/s (or 2480 kc/s for the higher frequency unit) and adjusting both trimmers for maximum output, repeating the adjustment several times. A final check at each end of the band, and readjustment if necessary should result in the output being flat within 1 db throughout the band.

The oscillators are calibrated at 10-kc intervals by use of the harmonic series generator and receiver and the oscillators may be set or checked at intermediate points by use of this same equipment. If the calibration drifts slightly through aging, it may be brought into agreement with the chart by an adjustment of the correction trimmer condenser.

Operating characteristics are as follows:

Power input: 110 v, 60 c at 35 watts.

R-f output: 2.0 to 2.4 Mc/s and 2.4 to 2.8 Mc/s, 50 mw approximately at 50 to 100 ohms.

Harmonic content

in output: second harmonic	- 60 db
third harmonic	- 70 db
fourth harmonic	- 80 db

Oscillator

constancy: Short-time variations (3-minute period), less than 1 c/s or 1 part in 2 million approximately.

Day-to-day variation in dial settings (for a maximum variation of 10° C in ambient temperature), less than 2 small dial divisions, or approximately 100 c/s at 2.0 to 2.8 Mc/s.

Backlash in micrometer-dial mechanism, less than 1 small dial division.

c. Parts List

Parts values not shown in the schematic diagram, Fig. 17, are as follows:

- T-2 pri.: 2.0 to 2.4 Mc/s; 56 turns No. 34 en. silk cov. wire on 1/2" x 1/2" cylindrical powdered-iron core.
2.4 to 2.8 Mc/s; 52 turns No. 34 en. silk cov. wire on 1/2" x 1/2" cylindrical powdered-iron core.
sec.: similar to primary in each case.
tertiary: 4 turns No. 28 en. silk cov. wire wound over low-potential end of secondary.
spacing: between primary and secondary cores, 1/16".
primary load resistor: 10,000 ohms, 1/2 watt.
trimmer condensers: C-11, C-12 and C-13, C-14; dual ceramic-mounted, mica-compression-type, 30 to 120 μ mf each section.
- T-3 Similar to T-2, except tertiary winding is 12 turns No. 28 en. silk cov. wire, tapped at 4th turn.

d. Illustrations

- Fig. 16. Layout drawing of adjustable-frequency oscillator; 2.0 to 2.4 Mc/s and 2.4 to 2.8 Mc/s.
Fig. 17. Circuit schematic of adjustable-frequency oscillator; 2.0 to 2.4 Mc/s and 2.4 to 2.8 Mc/s.
Fig. 18. Photograph of adjustable-frequency oscillator; 2.0 to 2.4 Mc/s and 2.4 to 2.8 Mc/s (top-front view).
Fig. 19. Photograph of adjustable-frequency oscillator; 2.0 to 2.4 Mc/s and 2.4 to 2.8 Mc/s (bottom view).
4. Three-Stage Frequency Multiplier; Outputs 85.5 to 92.7 Mc/s, 256.5 to 278.1 Mc/s, 769.5 to 834.3 Mc/s.

a. Description

The three-stage frequency multiplier has outputs with approximately 8% bandwidths at 90, 270 and 810 Mc/s. These outputs are used to drive silicon-crystal frequency multipliers, the harmonics from which constitute the standard frequencies in the microwave spectrum. Harmonics from the 12th through the 36th are used where complete coverage is required.

The first tripler stage uses an 829-B push-pull beam power tube with an untuned band-pass input circuit and a concentric-coupled, tuned output transformer. The second tripler stage uses an 832-A push-pull beam power tube with resonant parallel lines, condenser tuned. An untuned parallel-lines input circuit drives the final stage, a range switch being provided to reduce loading when the final stage is not being used. The third tripler stage uses two 2C40 disc-seal tubes in push-pull, operating with the grids grounded and utilizing a butterfly tank circuit. Filament switches are provided on the panel for turning off the 270 and 810-Mc stages when these outputs are not needed. A tuning meter is also provided for each stage.

A separate chassis contains the plate and filament supply, regulated bias supply and plate current meters for each stage. This unit also contains individual bias adjustment controls for regulating the power output of each stage.

b. Operation and service instructions

The dial gearings for the 90 and 270-Mc stages are chosen so that the operating bands cover about 80 divisions on the dial scales; for the 810-Mc stage, the operating band covers about 20 dial divisions. All dial readings increase with increasing frequency.

The 829-B tube may be changed by taking off the shield cover and removing the plate clips. If this tube is changed it may be necessary to retune the 30-Mc band-pass input transformer. These trimmers are adjusted by removing the bottom cover and tuning so as to give uniform grid excitation throughout the operating band. The converter-multiplier unit and regular connecting cable should be used during this adjustment as it was found that, when using a longer connecting cable, the trimmers could not be properly adjusted.

The 832-A tube may be changed by loosening the set screws in the tuning gear and disengaging the fiber condenser-drive shaft. The four mounting screws in the supporting base are then loosened and the plate clips slipped off the tube pins allowing the tube to be removed.

The 2C40 tubes may be changed by loosening the plate clips and unhooking the concentric filament leads at the lower end. The tube mounting ring may then be removed as a unit by taking out the four supporting screws.

Operating characteristics are as follows:

Power input: 110 v., 60 c. at 100 watts approximately

R-f input: 28.5 to 30.9 Mc/s at 1 watt, 100 ohms approximately

R-f output: 85.5 to 92.7 Mc/s at 3 watts, 50 to 100 ohms
256.5 to 278.1 Mc/s at 3 watts, 50 to 100 ohms
769.5 to 834.3 Mc/s at 1 watt, 50 to 100 ohms

Spurious frequencies (harmonics and side-frequencies) in the 90, 270, 810 Mc/s outputs when properly tuned, less than - 50 db.

Approximate working Q's of the output stages are as follows:

90-Mc stage 90
270-Mc stage 180
810-Mc stage 220

c. Parts list

Parts values not shown in the schematic diagram, Fig. 21, are as follows:

- T-4 Band-pass input transformer, 28.5 to 30.9 Mc/s
pri: 2 turns No. 28 en. silk cov. wire wound over center of secondary.
sec: 16 turns No. 32 en. silk cov. wire on 5/8" x 2-3/8" polystyrene grooved form.
tertiary: 12 turns, center-tapped, No. 32 en. silk cov. wire on 5/8" x 2-3/8" polystyrene grooved form, coupling with secondary adjustable.
loading: 100,000-ohm, 1 watt resistor across tertiary winding.
tuning condensers: dual ceramic, adjustable trimmers, 3 to 13 μ uf each.
- T-5 90 Mc transformer, tunable from 85.5 to 92.7 Mc/s; 3 turns, center-tapped of coaxial copper tubing approximately 1.8" outside dia., coil 1" dia. x 1" length. The inner wire is used as primary and outside shield used as secondary or grid winding. Output link consists of 1 turn No. 14 wire approximately 1/2" dia. at center of coil. Tuning condenser, split-stator type 2 to 12 μ uf, is connected across grid winding.
- T-6 270-Mc transformer, resonant parallel-lines type, tunable from 256.5 to 278.1 Mc/s. Primary consists of two 5/16" dia. copper tubes 5 1/2" long, spaced 3/4" center-to-center. Tuning is accomplished by a 2 to 12 μ uf split-stator condenser attached near center of lines. Output link is No. 10 copper wire loop 2" long by 3/4" spacing, placed 1" from low-potential end of lines.
- Grid excitation for the 810-Mc stage is through 1/8" dia. coaxial copper tubing of approximately same length as plate lines. This stage is cathode driven, the heater power being fed through the center wires. This line is untuned, but a shunting link is provided for operation on the 810-Mc band. This link is opened by a panel control to prevent loading the 270-Mc stage when power is not desired from the 810-Mc stage.
- T-7 810-Mc transformer, butterfly type, tunable output from 769.5 to 834.3 Mc/s; dia. 2 1/2", thickness 1/2", 4 stator plates, 3 rotor plates. Both stator and rotor plates are shunted by brass bars at the back edges on each side at the high-potential points to eliminate a secondary resonance occurring near the second harmonic range of the 270-Mc driving voltage. Output link 1/2" square, coupling adjustable, placed at high-current point at bottom of butterfly tank. Entire tank circuit shielded by 1/8" thick brass box 5" x 5" x 2-3/8".

d. Illustrations

Fig. 20. Layout drawing of three-stage frequency multiplier and power supply.

Fig. 21. Circuit schematic of three-stage frequency multiplier and power supply.

Fig. 22. Photograph of three-stage frequency multiplier (front view).

Fig. 23. Photograph of three-stage frequency multiplier (top view).

Fig. 24. Photograph of three-stage frequency multiplier (bottom view)..

Fig. 25. Photograph of power supply for three-stage frequency multiplier (top-front view).

Fig. 26. Photograph of power supply for three-stage frequency multiplier (bottom view).

5. Distribution Amplifier; 100 kc/s

a. Description

The 100-kc distribution amplifier serves as a decoupling device and supplies 100 kc/s at controllable power levels as required by various units of the microwave frequency standard. The unit contains a buffer amplifier 6V6GT tube, operated as a cathode follower and four output amplifiers using 6G6G tubes. If more complete tube shielding is desired, 6V6 tubes may be substituted in all amplifier sockets without making any other changes.

b. Operation and service instructions

The output amplifier tubes may be operated under class A or class C conditions by adjustment of the input controls for each stage. Because of the comparatively low Q values of the output transformers, considerable harmonic distortion will result in the output under class C conditions. This is no great disadvantage, as in the following units these harmonics are purposely generated in most cases.

Alignment of the trimmer condensers on the transformers for maximum output may be done by using a 100-ohm resistive load and indicating meter. The two trimmers in each transformer are in parallel.

Operating characteristics are as follows:

Power input: 110 v., 60 c. at 40 watts approximately

R-f input: 100 kc/s, 50 to 100 mw at 100 ohms

R-f output: four outputs 100 kc/s, 100 mw maximum at 100 ohms

Distortion: approximate distortion in output (largely second harmonic)

Class A:	no load	-60 db
	100-ohm load	-40 db
Class C:	no load	-45 db
	100-ohm load	-25 db

c. Parts list

Parts values not given in the schematic diagram, Fig. 28, are as follows:

T-1 through T-5; 100-kc transformers, Aladdin Radio Industries part No. S-6568 with secondaries added over primary windings, consisting of 30 turns of 7/41 litz wire. Primary inductance in shield can 11.1 mh. Dual ceramic-mounted, air-dielectric tuning condensers 90 to 135 μ f each, connected in parallel.

d. Illustrations

Fig. 27. Layout drawing of distribution amplifier; 100 kc/s

Fig. 28. Circuit schematic of distribution amplifier; 100 kc/s

Fig. 29. Photograph of distribution amplifier; 100 kc/s (top-front view)

Fig. 30. Photograph of distribution amplifier; 100 kc/s (bottom view)

6. Adjustable-Frequency Oscillator; 500 to 600 kc/s

a. Description

This oscillator is used, in conjunction with the decade-frequency generator and the frequency multiplier and dual frequency converter units, to give continuous frequencies of 2.0 to 2.8 Mc/s of higher stability and finer control for use with the main converter and multipliers.

The oscillator is a Lampkin Laboratories type 103, to which has been added a highly filtered, regulated power supply and two radio-frequency output stages. The oscillator circuit in the Lampkin unit is essentially unchanged. A cathode-coupled buffer stage drives the 100-ohm output stage directly and is coupled through a low-pass filter to the 500-ohm output stage. Output from the 500-ohm stage is used as a source of excitation for the frequency converter and must, therefore, be very free of harmonic components. The 100-ohm output stage may be switched to a position giving high harmonic output for frequency monitoring purposes. By this means, the 500 to 600-kc oscillator may be monitored on the same 2.0 to 2.4 Mc band used for one of the other oscillators. This gives the same number of calibration points on all of the oscillators and higher degree of monitoring accuracy for the 500 to 600-kc unit.

The screw-adjustment type of calibration-correction condenser has been replaced with a dial-operated trimmer which also serves as a fine-range tuning condenser where extreme precision is required.

b. Operation and service instructions

The band-pass output transformers reduce the harmonic output and allow low-impedance coupling to the converter unit. These double-tuned transformers are over-coupled and loaded so as to give essentially flat response throughout the operating band. Adjustment of the trimmers is most easily carried out by using the proper load resistor (100 or 500 ohms) and a vacuum-tube voltmeter on the output, setting the oscillator to 515 kc/s and adjusting both trimmers for maximum output, repeating the adjustment several times. A final check at each end of the band, and readjustment if necessary, should result in the output being flat within 1 db throughout the band.

The 1000-ohm pi-section grid filter is so adjusted that the m-derived half-sections offer maximum attenuation to the second harmonic at different points in the operating range. The operating parameters of the 6SK7 amplifier stage are chosen for minimum harmonic output.

The 6AC7 amplifier stage operates at a higher input level and a high-pass network supplies adequate harmonic output for monitoring the frequency at any multiple value up to the tenth harmonic.

The fine-tuning or calibration-correction condenser covers a range of ± 3 main dial divisions, or approximately ± 50 c/s at 500 kc/s.

Operating characteristics are as follows:

Power input: 110 v., 60 c. at 45 watts.

R-f output: (1) 500 to 600 kc/s, 30 mw. at 200 to 500 ohms, second harmonic -70 db, other harmonics -100 db.

(2) 500 to 600 kc/s, 100 mw. at 50 to 100 ohms, or harmonics as high as 10th.

Oscillator constancy: Short-time variations (3-minute period) less than 1 part in 2 million.

Dial backlash: less than 1 small dial division.

c. Parts list

Parts values not shown in the circuit schematic, Fig. 32, are as follows:

T-1, T-2: Band-pass output transformers, 500 to 600 kc/s

pri: 185 turns 7/41 litz wire wound on 1/2" x 1/2" powdered-iron core, inductance 0.85 mh.

pri loading: 25,000-ohm 1/2 watt resistor

pri tuning: adjustable air-trimmer, 5 to 55 μ f, fixed silvered mica 75 μ f.

sec: similar to primary, except loading resistor 50,000 ohms 1/2 watt

tertiary: 25 turns 7/41 litz wire wound over low-potential end of secondary.

spacing: between primary and secondary core edges $1/8"$.

Pi-network filter:

L-4: 110 turns 7/41 litz wire wound on $1/2" \times 1/2"$ powdered-iron core, inductance 360 μh .

L-3, L-5: 60 turns 7/41 litz wire wound on $1/2" \times 1/2"$ powdered-iron core, inductance 110 μh .

C-2, C-3: 290 μmf , silvered mica

C-1: 220 μmf , silvered mica

C-4: 170 μmf , silvered mica

d. Illustrations

Fig. 31. Layout drawing of adjustable-frequency oscillator; 500 to 600 kc/s.

Fig. 32. Circuit schematic of adjustable-frequency oscillator; 500 to 600 kc/s.

Fig. 33. Photograph of adjustable-frequency oscillator; 500 to 600 kc/s (front view).

Fig. 34. Photograph of adjustable-frequency oscillator; 500 to 600 kc/s (top view).

Fig. 35. Photograph of adjustable-frequency oscillator; 500 to 600 kc/s (bottom view).

7. Frequency Multiplier and Dual Frequency Converter; outputs 1500 to 3000 kc/s, 1000 to 2000 kc/s, 2000 to 3000 kc/s

a. Description

This unit provides a means of using the output of the decade frequency generator and the low-frequency adjustable oscillator to obtain marker frequencies and high-precision complete coverage in the microwave spectrum. In this function, its output is used with the main converter-multiplier equipment in place of the regular 2.0 to 2.8-Mc oscillators.

These three auxiliary units may also be used directly or through harmonic generators as a frequency standard in the low, medium or high frequency range.

The unit contains three tunable channels covering the ranges as given. The circuits of the three stages are identical with the exception of the input coupling arrangements and the inductance values of the filter transformers. The second and third channels, normally used as frequency converters, may also be used as frequency multipliers by supplying the proper frequencies at the left-hand input jacks.

As shown in the schematic diagram, Fig. 37, the first tube (6AC7) in each channel operates as a multiplier or converter. An input of 3 to 6 volts is supplied to the No. 1 grid in both cases. In the converter stages,

the lower frequency, which might have harmonics that fall in the desired output range, is supplied to the cathode at the low level of 0.1 to 0.2 volt to suppress the generation of harmonics in the converter tube.

The first 6SK7 amplifier tube is operated under class C conditions with the rectified grid current supplying a variable bias to both the first and second tubes, thus supplying an automatic gain control action. Coil windings are used which have considerably higher Q at the low-frequency end of the operating band, thus giving a fairly constant impedance and uniform voltage gain throughout the band. The 6SK7 output stage operates class A at about 0.1 watt to minimize the generation of harmonics.

Very complete shielding and decoupling networks reduce the interference between the three channels to a negligible amount.

b. Operation and service instructions

The adjustable oscillator should normally be used with the third channel as this reduces by one the number of controls that must be kept in tune as the frequency is varied. If an output frequency is required, on which harmonic cross-over interference is experienced, the oscillator may be used with the center channel and the interference thus eliminated by proper choice of the input frequencies to the converters. No harmonic interference is experienced when fixed frequencies only are used in the converters.

In tuning the converter channels one should be certain that the desired output frequency is selected, as the fundamental or harmonics of the frequencies applied to the left-hand jacks may be obtained if they fall within the tuning ranges.

At some points in the tuning ranges a slight double peaking effect may be noticed due to mistracking or to a slight coupling backlash. Final tuning adjustment of the converter stages may be made for the clearest signal on the analyzer screen.

For many of the fixed frequency marker points only the frequency multiplier channel need be used. All of the fixed frequency points from 2.0 to 2.8 Mc/s may be obtained by using the multiplier and only one converter channel. Harmonics as high as the tenth may be obtained from the multiplier channel at full power output.

Alignment is carried out by adjusting the trimmer condensers mounted in the transformers. Only those trimmers with one end of the slot notched are used (maximum capacity occurs when the notch is toward center of transformer). The multiplier and first converter channel are aligned for maximum output at the high-frequency end with the dials set at 100. The second converter channel is similarly aligned with the dial set to 80 for the high-frequency end of the band. Each channel should be checked for proper range coverage and uniformity of gain and slight readjustments made if necessary.

Operating characteristics are as follows:

Power input: 110 v., 60 c. at 70 watts

R-f input: untuned inputs, voltage range 3 to 6 volts.

R-f outputs: 1500 to 3000 kc/s, 1000 to 2000 kc/s, 2000 to 3000 kc/s
at 100 ohms, 0.1 watt.

Output purity: Harmonics in output

2nd	-40 to -60 db
3rd and 4th	-50 to -70 db
5th and higher	-80 to -100 db

Harmonic cross-over interference:

from 4th harmonic of oscillator	-55 db
from 5th and higher harmonics	-80 db

Harmonic interference between channels (channel No. 1
at 1000 kc/s and channel No. 2 at 2000 kc/s)
-80 db

Channel voltage gain:	No. 1 (multiplier)	55 db
	No. 2 (first converter)	45 db
	No. 3 (second converter)	35 db

c. Parts list

Condenser and resistor data are given in the schematic diagram, Fig. 37.

Tunable filter-transformer data are given in the following table:

Trans.	f (kc/s)	winding	turns	L (μ h)	spacing or location
T-1	1500 to 3000	pri	48	65	3/4 inch
		sec	48	65	
T-2	1500 to 3000	pri	48	65	over pri
		sec	1		
T-3	1500 to 3000	pri	48	65	over pri
		sec	2		
T-4	1000 to 2000	pri	72	135	25/32 inch
		sec	72	135	
T-5	1000 to 2000	pri	72	135	over pri
		sec	2		
T-6	1000 to 2000	pri	72	135	over pri
		sec	3		
T-7	2000 to 3000	pri	33	30	3/4 inch
		sec	33	30	

Trans.	f (kc/s)	winding	turns	L (μ h)	spacing or location
T-8	2000 to 3000	pri sec	33 1		over pri
T-9	2000 to 3000	pri sec	33 1 1/2	30	over pri

General coil data

On all of the above transformers the coils are wound on 1/2" x 1/2" powdered-iron cores (Aladdin Radio Industries, part No. 10-101). On the first transformer in each channel, separate cores are used for primary and secondary windings with spacing between core edges as given. On the other transformers primary and secondary windings are on the same cores. Tuned windings are of 7/41 litz wire, wound with a cam throw of 0.43 inch; low impedance windings are of 10/41 litz wire.

Trimmer condensers in the first two channels are Sickles Co. No. SD-3219, 3 to 25 μ mf, and in the third channel Sickles Co. No. SD-3157, 5 to 55 μ mf. Tuning condensers are Hammarlund No. MCD-140-M, 8 to 145 μ mf each section, two two-gang units being used in each channel.

Shield cans are aluminum, Sickles Co., size 4" x 2" x 1-7/16" x 0.32" thick.

d. Illustrations

Fig. 36. Layout drawing of frequency multiplier and dual frequency converter; outputs 1500 to 3000 kc/s, 1000 to 2000 kc/s, 2000 to 3000 kc/s.

Fig. 37. Circuit schematic of frequency multiplier and dual frequency converter.

Fig. 38. Photograph of frequency multiplier and dual frequency converter (front view).

Fig. 39. Photograph of frequency multiplier and dual frequency converter (top view).

Fig. 40. Photograph of frequency multiplier and dual frequency converter (bottom view).

8. Decade Frequency Generator; outputs at 100-kc intervals from 100 to 1000 kc/s

a. Description

The decade frequency generator, when used with the frequency multiplier and dual frequency converter, makes available frequencies at 100-kc intervals in the range 2.0 to 2.8 Mc/s which are entirely controlled from the primary

standard of frequency. These frequencies may be used to generate marker frequencies throughout the microwave spectrum by use of the main converter and multiplier equipment. Complete coverage, at a higher stability and higher control precision, may also be obtained by using the 500-600 kc oscillator with this equipment.

The decade frequency generator will furnish, simultaneously, harmonics of 100 kc/s in the decade range of 100 to 1000 kc/s, at a power output of 0.1 watt each. Output impedance is nominally 100 ohms although performance is satisfactory between 50 ohms and open-circuit conditions. Separate switches and output jacks are provided so that any or all of the outputs may be operated at will. These frequencies are obtained by passing the 100-kc input frequency through a pulse-forming circuit arrangement which generates sharp pulses of approximately 0.5 microsecond duration with a peak power of about 1 watt. With this adjustment the harmonic content of the pulse output is approximately inversely proportional to the harmonic order. Tuned filters select and equalize the various harmonics. A separate type 6SK7 amplifier tube with single-tuned transformer coupling is used for each output frequency. These tubes are operated as class A amplifiers with voltage and load values chosen to minimize harmonic output.

A separate report, "Decade frequency generator", R213.1 b, Feb. 25, 1946, gives detailed design and operational data for this unit.

b. Operation and service instructions

The unit is normally operated from a regulated a-c supply and will not give uniform output from the various stages if the line voltage drops below about 105 volts. As in any multiplier, phase shifts causing frequency modulation in higher frequency stages may result if the unit is operated from unregulated supply voltage.

Realignment should seldom be required as all filter circuits are tuned with air-trimmer or silvered mica condensers. If necessary, the following procedure should be used after allowing the unit to stabilize for 1/2 hour. Plug in 100-kc input and align the pulse input transformer and the 100-kc output transformer. A 100-ohm load resistor and vacuum-tube voltmeter should be used on the outputs during alignment with trimmer adjustments progressing from harmonic bus to output circuit in sequence. A wide-band oscilloscope is useful for observing the pulse wave-form on the harmonic bus and the ratios of the output stages by obtaining Lissajou figures. It should be noted that the trimmers in the output transformers are wired in parallel for greater range, also, the 300 to 1000-kc grid input transformers each contain an unused trimmer. All used trimmers have been scribed at correct alignment points and should not deviate greatly from these points. Particular care should be observed on the input trimmers connecting to the harmonic bus as these will tune to several of the frequencies in most cases. After complete adjustment for maximum output all of the trimmers should be rechecked with all of the outputs operating.

Operating characteristics of the decade-frequency generator are as follows:

Power input: 110 v., 60 c. at 75 watts

R-f input: 110 kc/s, 0.1 watt at 100 ohms

R-f output: 100 to 1000 kc/s at 100-kc intervals, 0.1 watt each at 100 ohms

For one output only operating -- 100-ohm load, 4.5 to 5.5 volts
no load, 6 to 9 volts

For all outputs operating -- 100-ohm load, 3.2 to 3.7 volts
no load, 4.1 to 6.8 volts.

Spurious frequencies:

		db down	
		100-ohm load	no load
1000 kc/s, side-frequencies	$f \pm 100$ kc/s	65	75
	$f \pm 200$ kc/s	80	85
900 kc/s, side-frequencies	$f \pm 100$ kc/s	75	85
	$f \pm 200$ kc/s	100	100
800 to 200 kc/s, side-frequencies	$f \pm 100$ kc/s	90	100
	$f \pm 200$ kc/s	100	100
1000 to 200 kc/s, harmonics	$f \times 2$	60	65
	$f \times 3$	65	70
	$f \times 4$	80	80
100 kc/s, harmonics	$f \times 2$	50	70
	$f \times 3$	60	60

Above are minimum values and are approximately the same for all or only one output stage operating.

C. Parts list

Condenser and resistor data are given in the schematic diagram, Fig. 42. Resonant filter transformer data are given in the following table.

Trans.	f (kc/s)	use	winding	turns	L (μ h)	par. cond. (μ mf)	spacing (inches)
T-1	100	input	pri	500 (estimated)	11,100		
			sec	none			
T-2	100	plate	pri	250	1,700	1400	0
			sec	25			
T-3	200	grid	pri	400	4,100	125	1
			sec	400			

Trans.	f (kc/s)	use	winding	turns	L (μ h)	par. cond. (ppf)	spacing (inches)
T-4	200	plate	pri sec	114 16	420	1430	0
T-5	300	grid	pri sec	400 400	4,150 4,150	20 20	1
T-6	300	plate	pri sec	92 14	950	950	0
T-7	400	coupling	pri sec	400 250	4,150 1,800	50	3/4
T-8	400	grid	pri sec	50 200	80 1,130	100	1/2
T-9	400	plate	pri sec	76 12	190	750	0
T-10	500	coupling	pri sec	400 200	4,150 1,130	50	3/4
T-11	500	grid	pri sec	40 160	54 725	100	1/2
T-12	500	plate	pri sec	64 11	152	600	
T-13	600	coupling	pri sec	350 150	3,170 670	70	3/4
T-14	600	grid	pri sec	35 135	42 510	70	1/2
T-15	600	plate	pri sec	56 10	116	550	0
T-16	700	coupling	pri sec	300 125	2400 510	70	3/4
T-17	700	grid	pri sec	30 115	32 370	70	3/8
T-18	700	plate	pri sec	50 9	90	500	0
T-19	800	coupling	pri sec	250 100	1,800 310	70	3/4
T-20	800	grid	pri sec	25 100	25 310	70	1/4

Trans.	f (kc/s)	use	winding	turns	L (μ h)	par. cond. (μ pf)	spacing (inches)
T-21	800	plate	pri sec	44 8	74	450	0
T-22	900	coupling	pri sec	225 75	1,425 180	130	5/8
T-23	900	grid	pri sec	22 85	22 220	70	1/8
T-24	900	plate	pri sec	42 7	65	400	
T-25	1000	coupling	pri sec	200 50	1,130 80	230	5/8
T-26	1000	grid	pri sec	20 75	18 180	100	1/8
T-27	1000	plate	pri sec	40 6	60	350	0

General coil data

On all of the above transformers primary and secondary windings are on separate powdered-iron cores. Spacing between primary and secondary core edges is given.

Core material: R-f powdered-iron, cylindrical 1/2" x 1/2" with 3/16" dia. hole (Aladdin Radio Industries, part No. 10-101).

Wire: Coil windings are of 7-strand No. 41 litz wire with the exception of the plate transformer secondaries which are of 10/41 litz wire. Windings are universal type, with a 5/16" throw. Two layers of scotch electrical tape are placed between cores and windings and finished windings are coated with polystyrene cement.

Trimmer condensers: Dual air-dielectric, ceramic-mounted trimmer condensers (F. W. Sickles Co. No. SD-3157), 5 to 55 μ pf each, are used on all transformers except the 100-kc input transformer which is an Aladdin Radio Industries S-6568, having trimmers of 85 to 125 μ pf each.

Shunting condensers: Where additional capacity is required, silvered mica condensers are shunted across the variable air-trimmers.

Coil mounting: The coils are mounted on the tuning condensers by means of threaded bakelite rods of the proper length through the holes in the core material and with bakelite spacers where indicated. A threaded bakelite washer is used as a retaining nut.

Output leads: The connections between the output transformers and the panel jacks are made with flexible concentric conductors with the shields grounded at the jacks.

Shield cans: Aluminum shield cans are from F. W. Sickles Co., size 4" x 2" x 1 7/16" x 0.032" thick.

Inductance values: All inductance values are given as assembled for use with shield cans and primary and secondary cores in place.

d. Illustrations

Fig. 41. Layout drawing of decade frequency generator; outputs at 100-kc intervals from 100 to 1000 kc/s.

Fig. 42. Circuit schematic of decade frequency generator

Fig. 43. Photograph of decade frequency generator (front view).

Fig. 44. Photograph of decade frequency generator (top view).

Fig. 45. Photograph of decade frequency generator (bottom view).

9. Harmonic Series Generator

a. Description

This unit contains three class C amplifier stages, using 6AC7 tubes, and having a high degree of intermodulation through use of a common plate load resistor. The untuned inputs may be supplied with frequencies to give numerous check points in any desired region of the low, medium or high frequency spectrum. Normally, standard-frequency inputs of 100 kc/s and 10 kc/s are used in checking or monitoring the adjustable oscillators. An audio-frequency interpolation oscillator with a range of 0 to 5000 c/s is used for determination of values between these check points.

The third input channel may be operated at very low level at an audio frequency (usually 1000 c/s) for very accurately zero-beating the oscillators to these check points for calibration purposes. As an alternate arrangement, the receiver "S" meter may be used as a very low beat indicator.

The unit also contains mixing controls for adjusting the relative levels of the standard and unknown frequencies at the receiver input.

b. Operation and service instructions

In operation, the proper input and output connections are completed and the control dials set for most sensitive conditions. Use of a fixed line insertion-type attenuator (20 db) for reducing the output from the adjustable-frequency oscillators gives a smoother adjustment of the mixing controls.

Operating characteristics are as follows:

Power input: 110 v. 60 c. at 35 watts

R-f input: nominally 100 kc/s, 10 kc/s and 1 kc/s at 500 ohms, 0.1 watt

R-f output: output sufficient for frequency measurements up to 100th harmonic (10 Mc/s for 100 kc/s input)

c. Parts list

Values of all components are given in the schematic diagram, Fig. 46.

d. Illustrations

Fig. 46. Circuit schematic of harmonic series generator.

Fig. 47. Photograph of harmonic series generator (top-front view).

Fig. 48. Photograph of harmonic series generator (bottom view).

10. Audio Frequency Interpolation Oscillator

This unit is a General Radio type 617-C Interpolation Oscillator.

Operating characteristics are as follows:

Power input: 110 v., 60 c. at 20 watts

A-f output: 0 to 5000 c/s at 7 volts, 20,000 ohms

Accuracy ± 1 c/s when standardized at intervals of 100 c/s.

11. Multi-Band Receiver and Monitoring Speaker

The receiver is a National Co. NC-200 RG rack-mounting type; frequency range 490 to 30,000 kc/s; complete with panel mounted speaker.

Power consumption is approximately 100 watts.

12. Wide-Band Oscilloscope

The oscilloscope is a 3-inch, rack-mounted type manufactured by Research Construction Co., Cambridge, Mass.

13. Frequency Divider; 100 kc/s to 10 kc/s to 1 kc/s to 0.1 kc/s.

This unit is a Hewlett Packard 100-A Low Frequency Standard. The 100-ke crystal supplied with the unit was removed and the oscillator tube converted to a 100-ke buffer amplifier by supplying a standard-frequency voltage from one of the distribution amplifier outputs to the grid of this tube. This input is connected through the terminals on the rear of the unit normally used for 100-ke output. Output from the distribution amplifier is adjusted to the

center of the range which gives a stable 10 to 1 division. The other divider stages should require no adjustment. The unit was removed from the wooden case and supplied with a bottom cover and a ventilated dust cover.

Acknowledgments

Grateful acknowledgment is given to Messrs. V. E. Heaton and R. H. McCracken for their assistance in the design and construction of the equipment.

Thanks are also due Messrs. F. J. Gaffney, L. B. Young, P. A. Hower and N. C. Colby of the MIT Radiation Laboratory for their help.

September 1946.

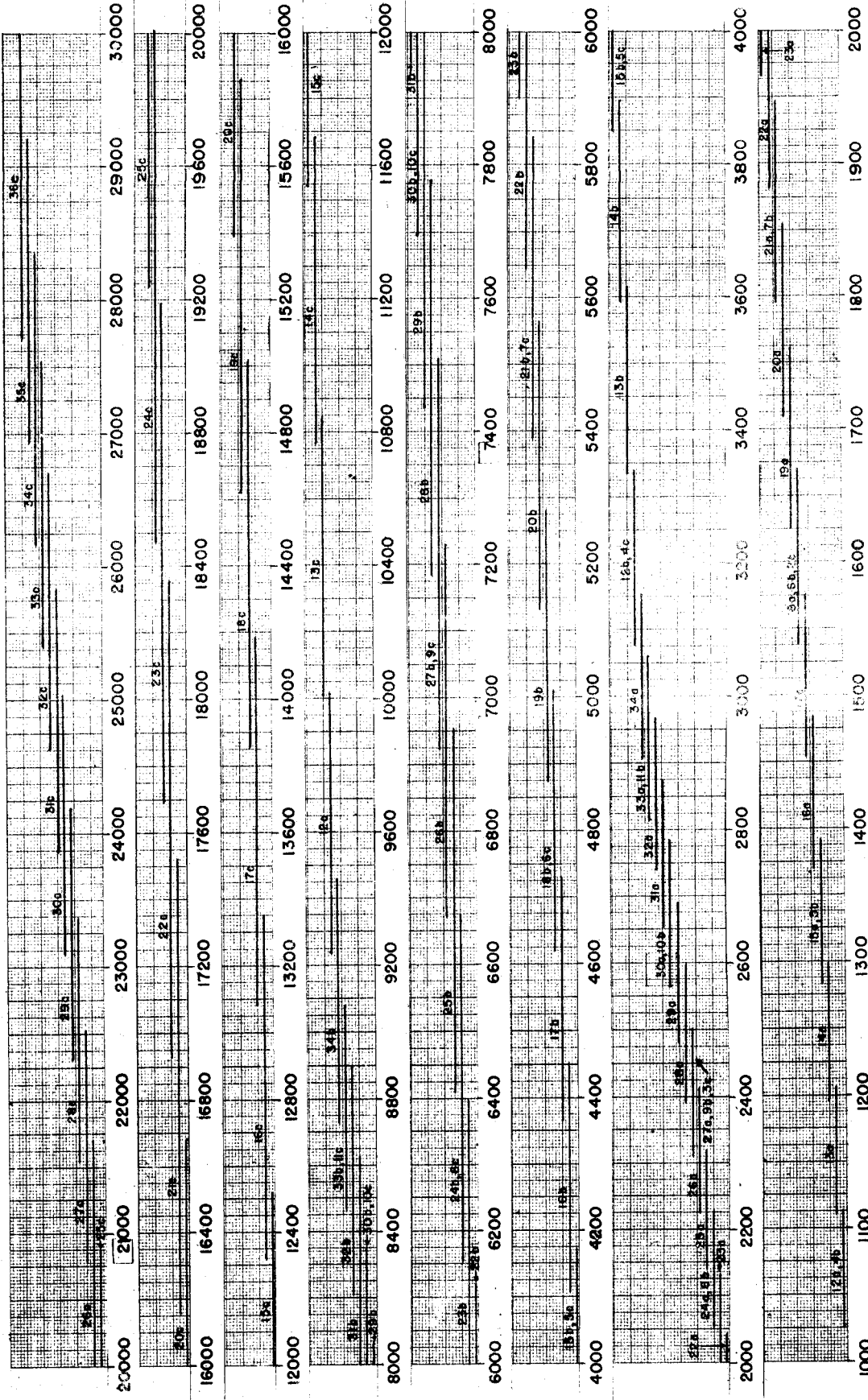

FREQUENCY Mc/s (output of silicon crystal frequency multiplier)

- a) harmonics of input range 85.5 to 92.7 Mc/s
- b) harmonics of input range 256.5 to 278.1 Mc/s
- c) harmonics of input range 769.5 to 834.3 Mc/s

Fig. 2.

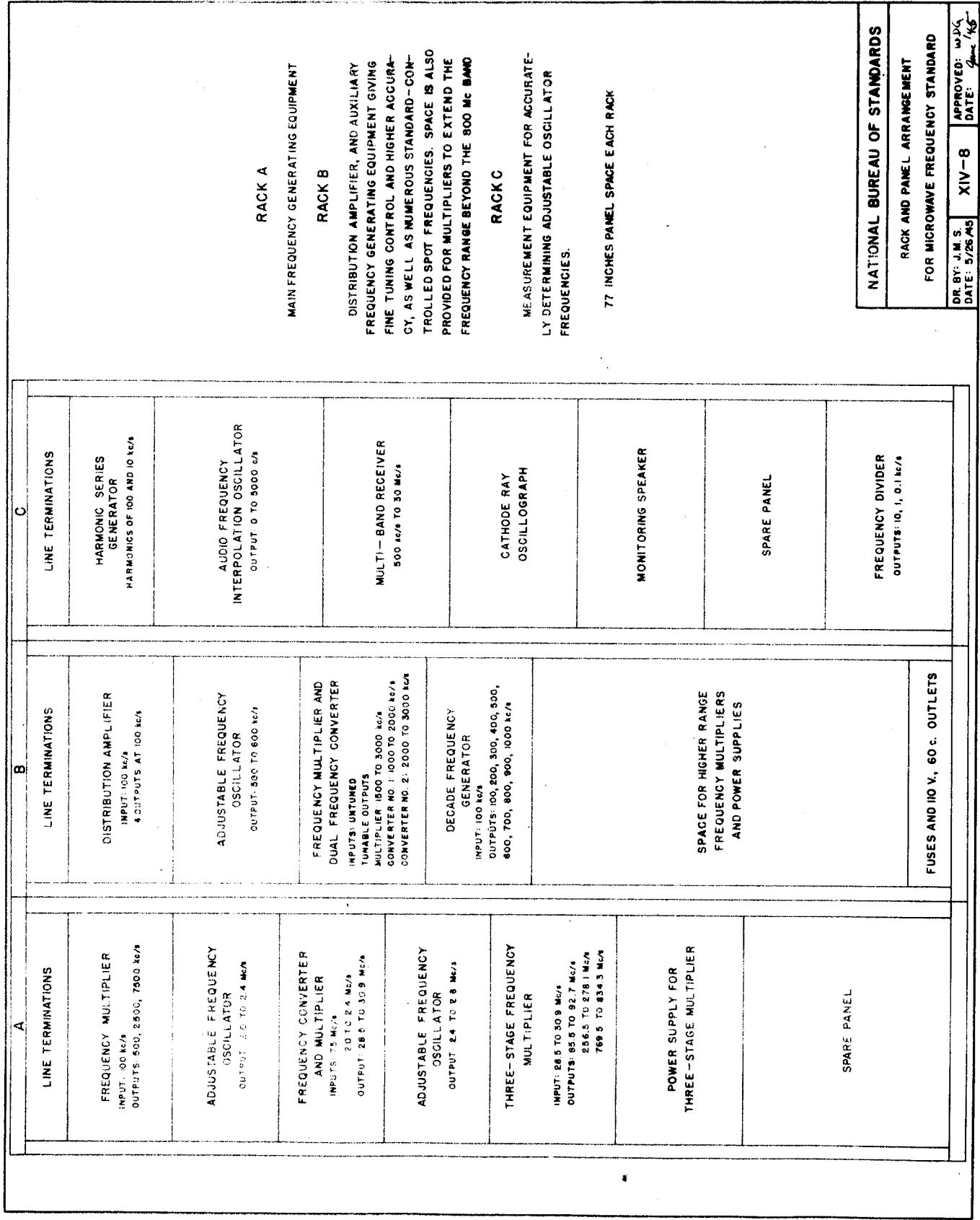

RACK A

MAIN FREQUENCY GENERATING EQUIPMENT

RACK B

DISTRIBUTION AMPLIFIER, AND AUXILIARY FREQUENCY GENERATING EQUIPMENT GIVING FINE TUNING CONTROL AND HIGHER ACCURACY, AS WELL AS NUMEROUS STANDARD-CONTROLLED SPOT FREQUENCIES. SPACE IS ALSO PROVIDED FOR MULTIPLIERS TO EXTEND THE FREQUENCY RANGE BEYOND THE 800 Mc BAND

RACK C

MEASUREMENT EQUIPMENT FOR ACCURATELY DETERMINING ADJUSTABLE OSCILLATOR FREQUENCIES.

77 INCHES PANEL SPACE EACH RACK

NATIONAL BUREAU OF STANDARDS

RACK AND PANEL ARRANGEMENT FOR MICROWAVE FREQUENCY STANDARD

DR. BY: J. M. S. APPROVED: W. J. G.
DATE: 5/26/45 XIV-8 DATE: June 1/45

FIG. 3

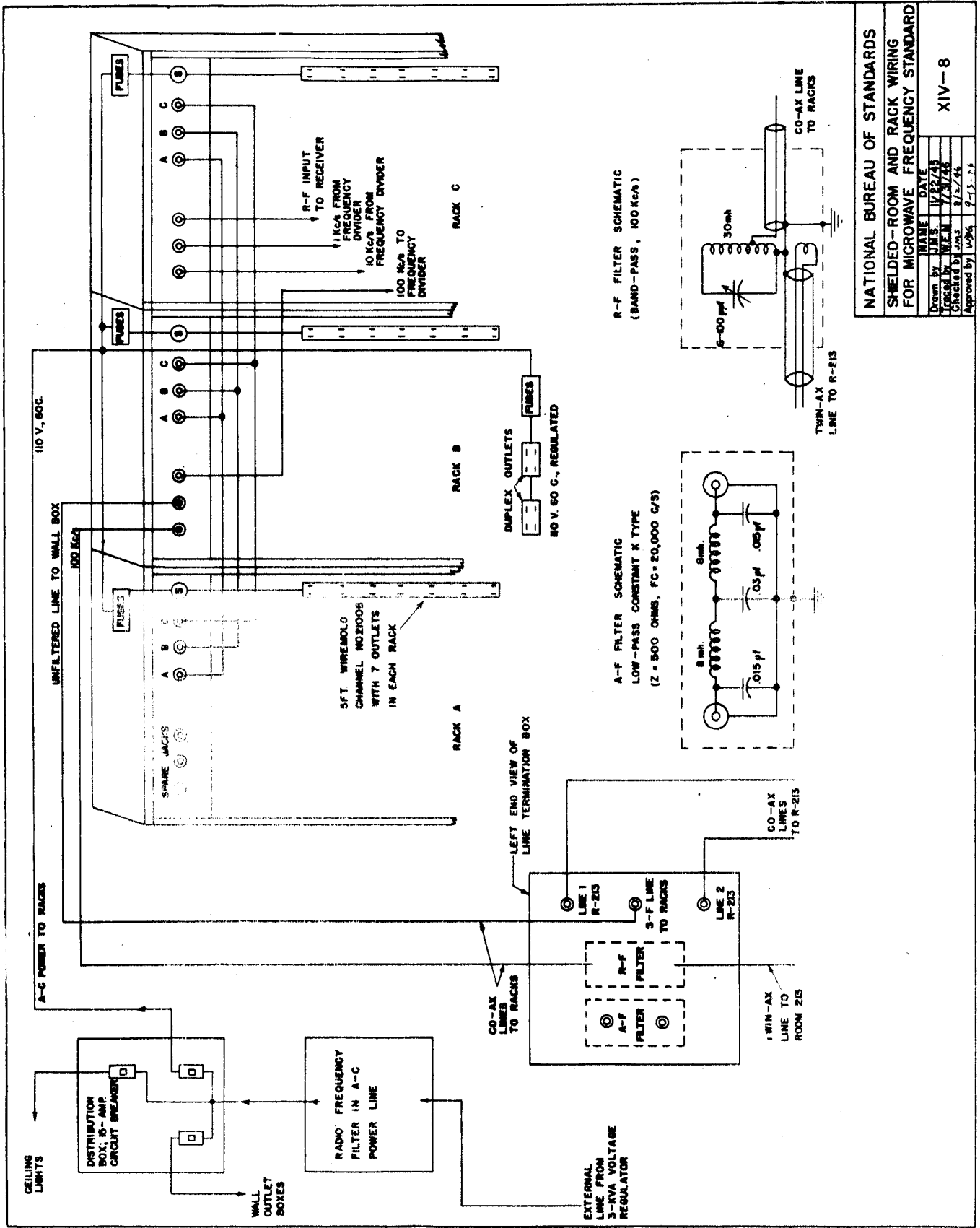

NATIONAL BUREAU OF STANDARDS
 SHIELDED-ROOM AND RACK WIRING
 FOR MICROWAVE FREQUENCY STANDARD

NAME	DATE
Drawn by J.M.S.	11/22/43
Checked by W.F.M.	11/30/43
Checked by J.M.S.	8/2/46
Approved by W.D.G.	9-15-46

XIV-8

FIG. 4

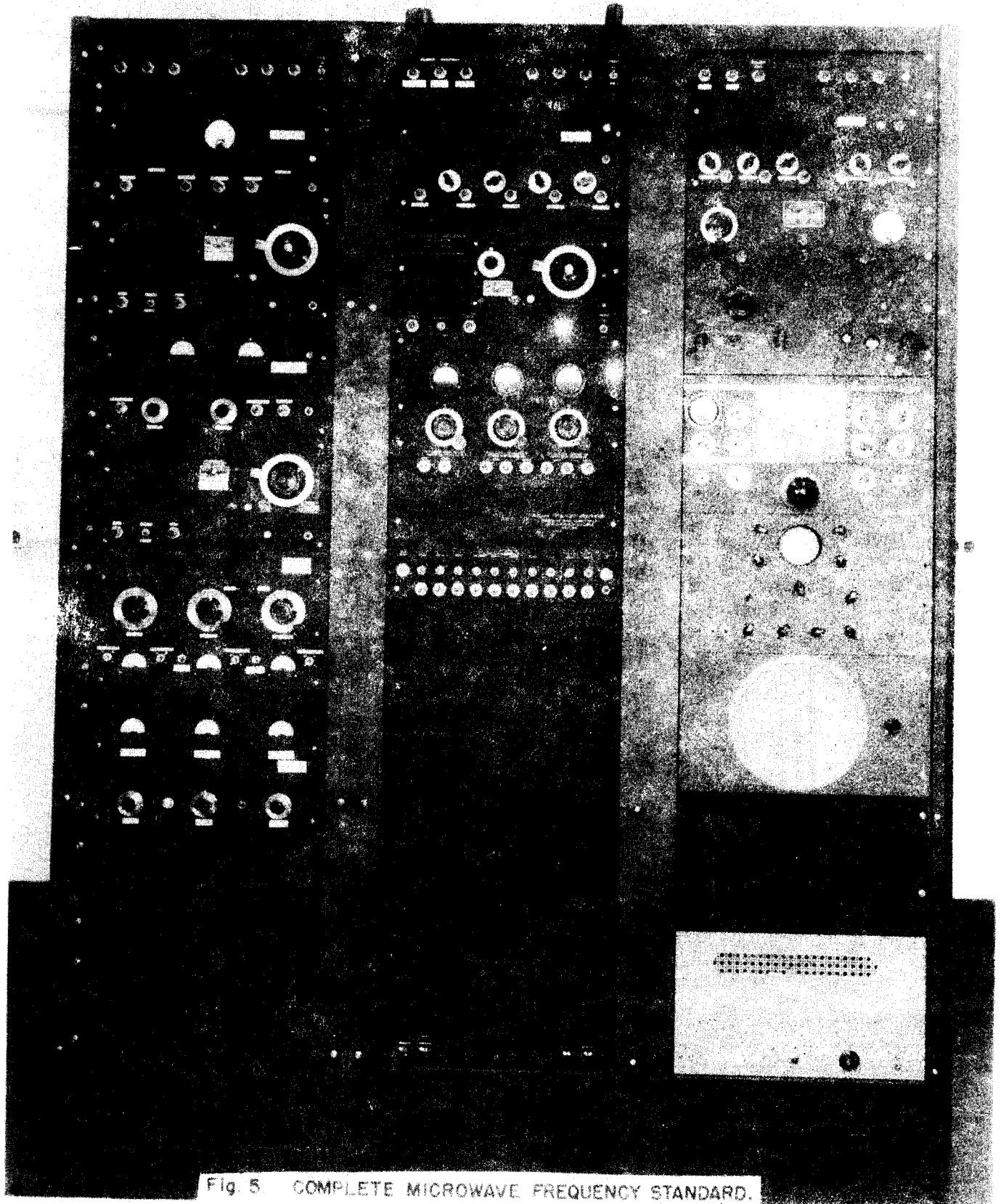

Fig. 5 COMPLETE MICROWAVE FREQUENCY STANDARD.



COMPLETE MICROWAVE FREQUENCY STANDARD WITH CONNECTING LEADS.

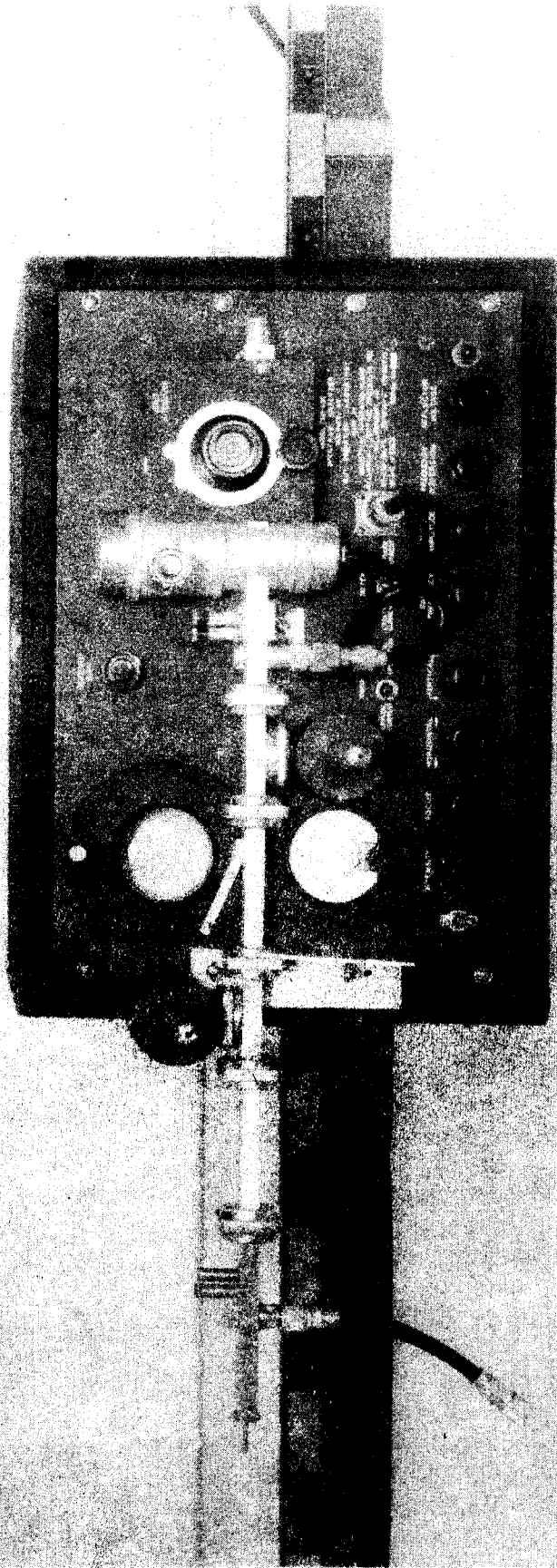

Fig. 7. SPECTRUM ANALYZER, FREQUENCY METERS AND CRYSTAL MULTIPLIER; 8500 TO 10,000 Mc/s.

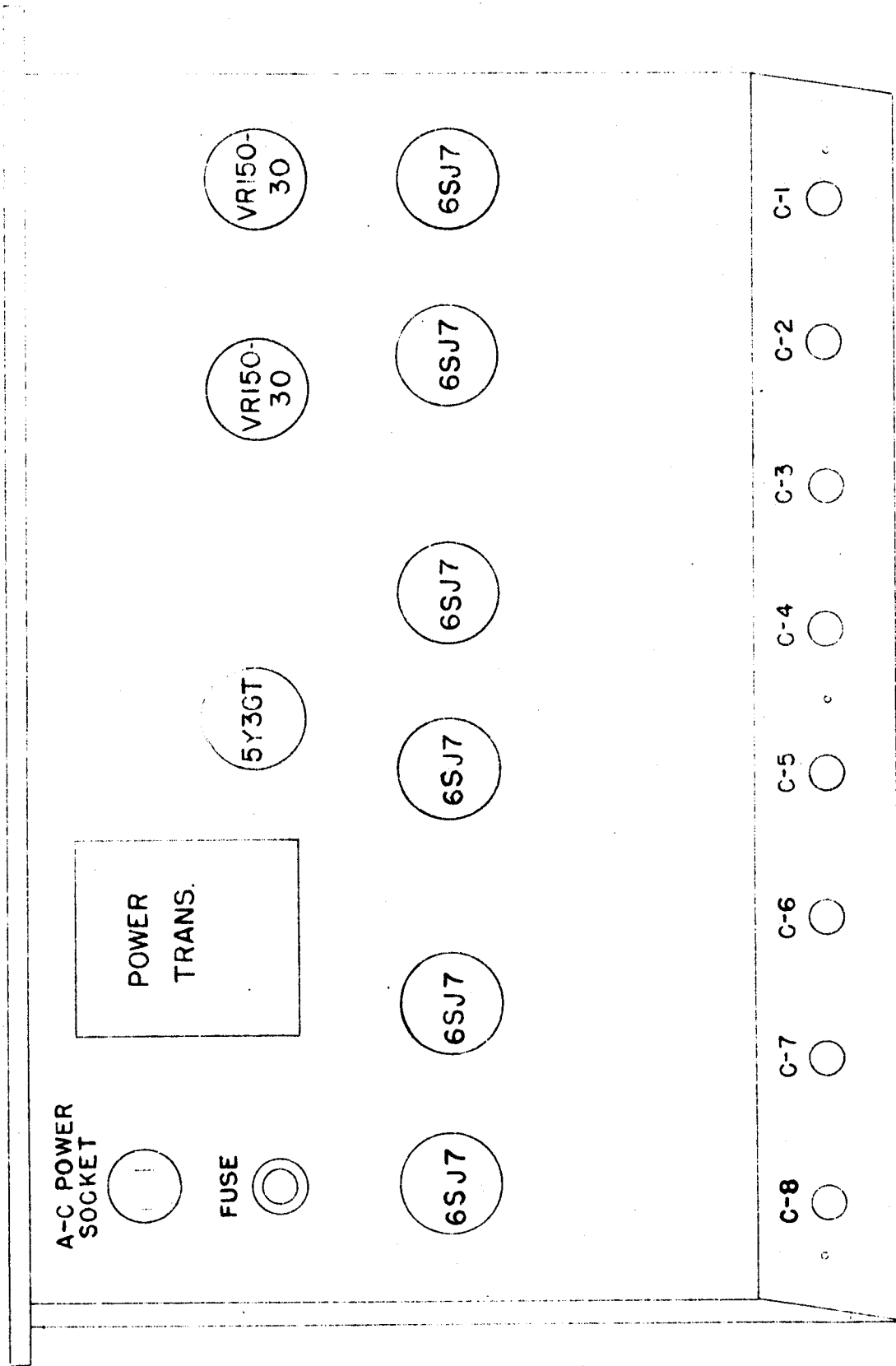
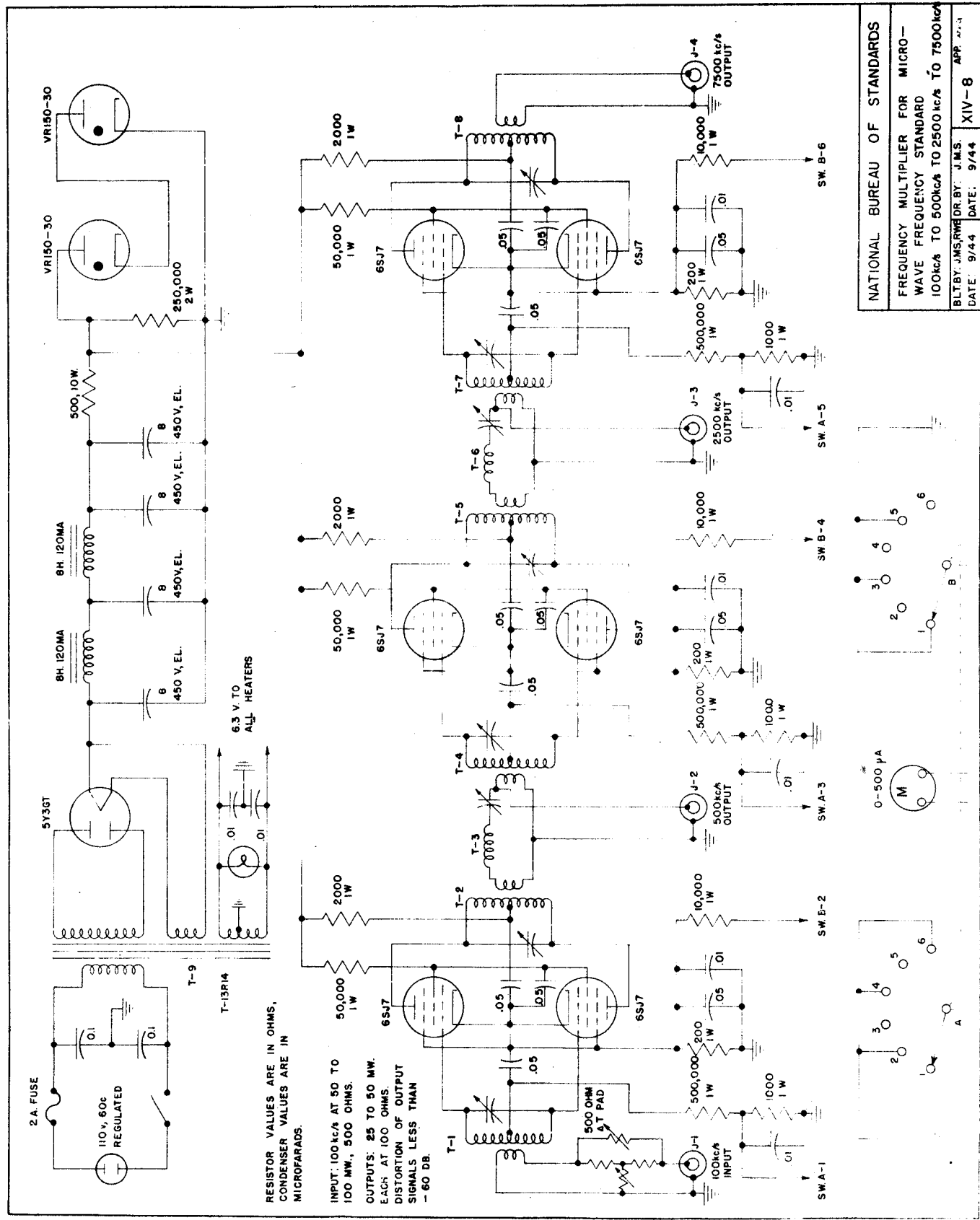

Fig. 8. LAYOUT DRAWING OF FREQUENCY MULTIPLIER; 100 TO 7500 kc/s (TOP-REAR VIEW)



RESISTOR VALUES ARE IN OHMS,
 CONDENSER VALUES ARE IN
 MICROFARADS.

INPUT: 100 kc/a AT 50 TO
 100 MW, 500 OHMS.

OUTPUTS: 25 TO 50 MW
 EACH AT 100 OHMS.
 DISTORTION OF OUTPUT
 SIGNALS LESS THAN
 - 60 DB.

NATIONAL BUREAU OF STANDARDS
 FREQUENCY MULTIPLIER FOR MICRO-
 WAVE FREQUENCY STANDARD
 100 kc/a TO 500 kc/a TO 2500 kc/a TO 7500 kc/a

BLT BY: JMS,RWB DR. BY: J.M.S. APP. 11.3
 DATE: 9/44 DATE: 9/44 XIV-8

FIG 9

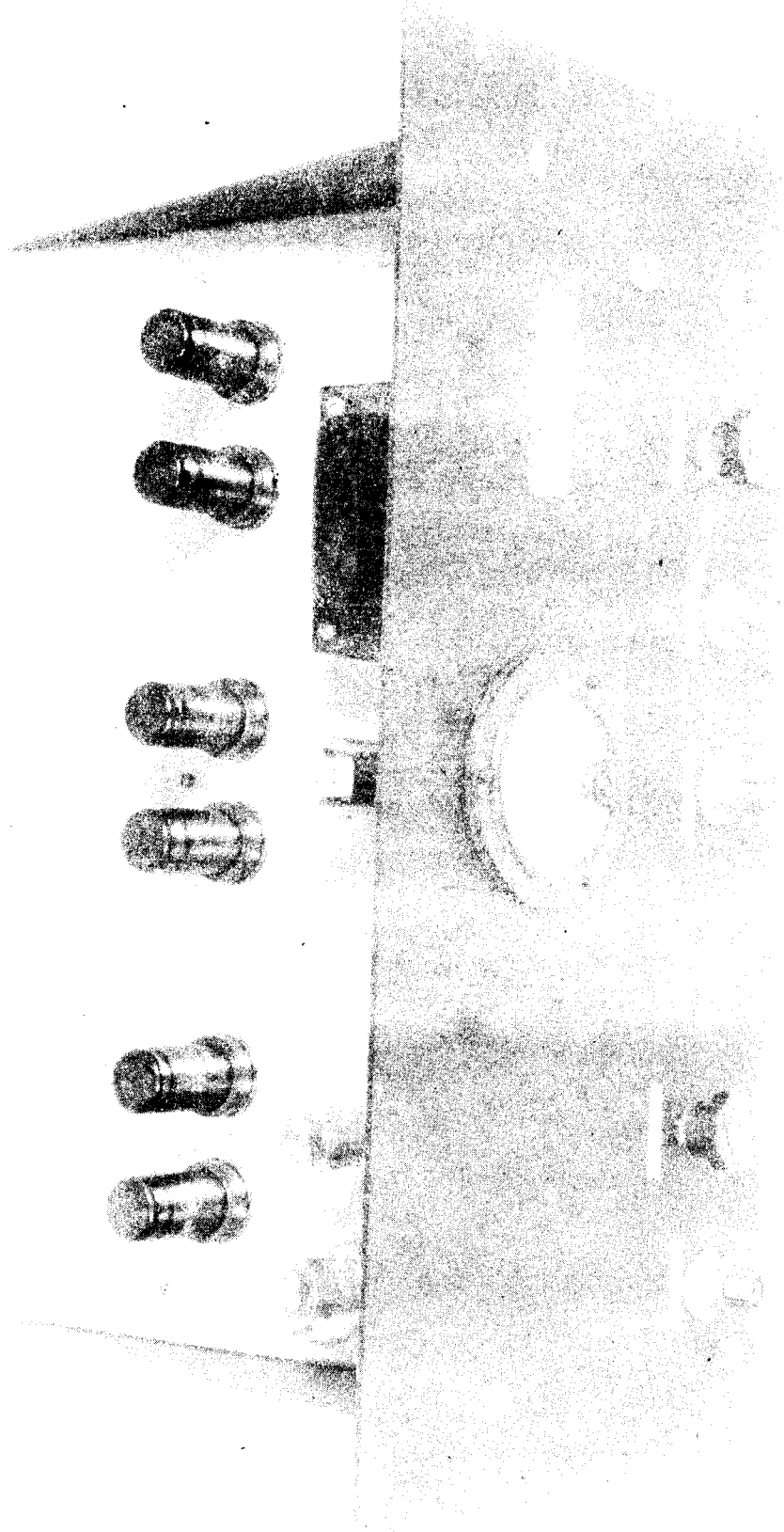

FIG. 10. FREQUENCY MULTIPLIER, 100 TO 7500 Mc/s (TOP-FRONT VIEW).

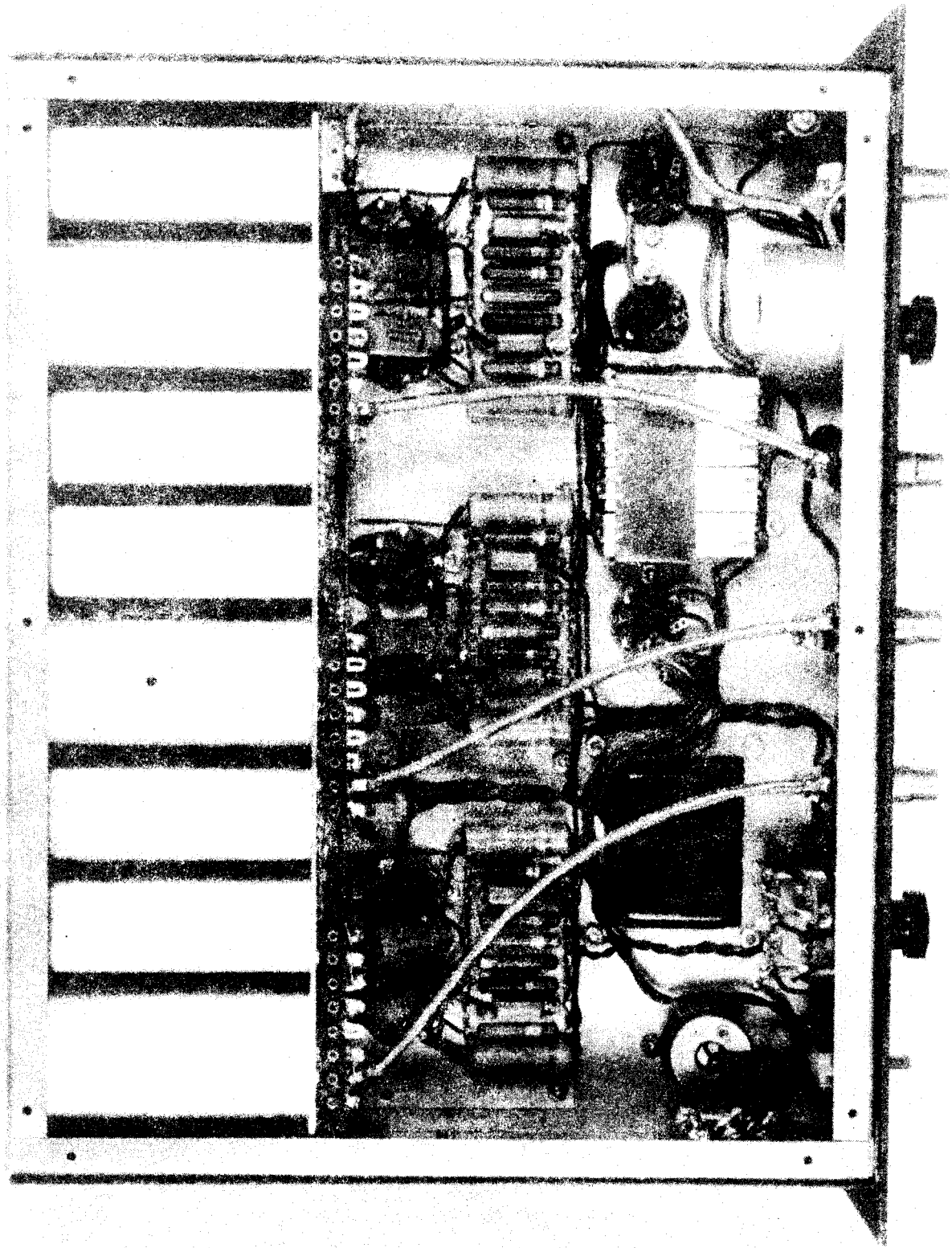

FIG. 11. FREQUENCY MULTIPLIER, 10 TO 1500 KHZ BOTTOM VIEW

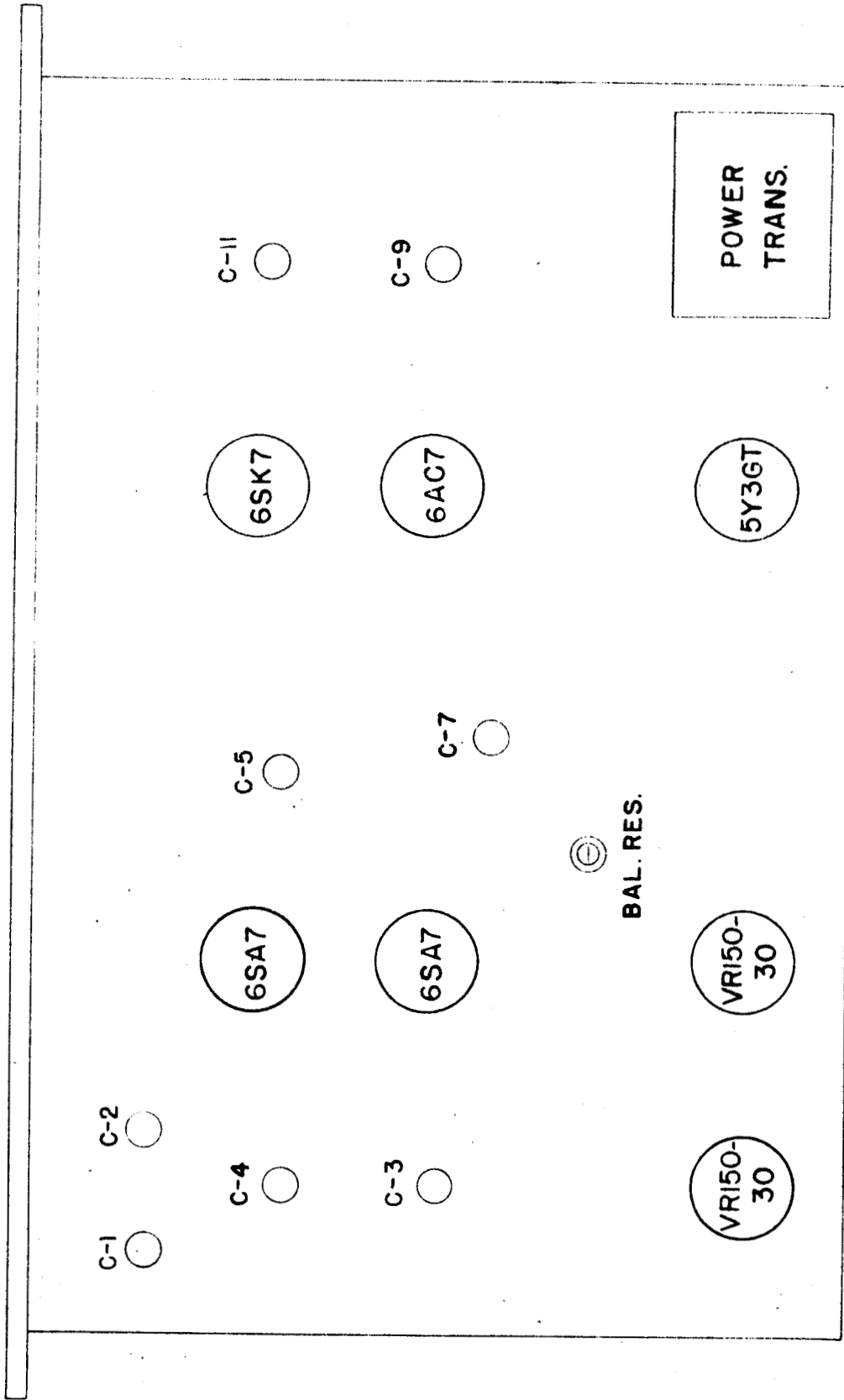

Fig 12. LAYOUT DRAWING OF FREQUENCY
 CONVERTER-MULTIPLIER; OUTPUT
 28.5 TO 30.9 Mc/s
 (TOP-REAR VIEW)

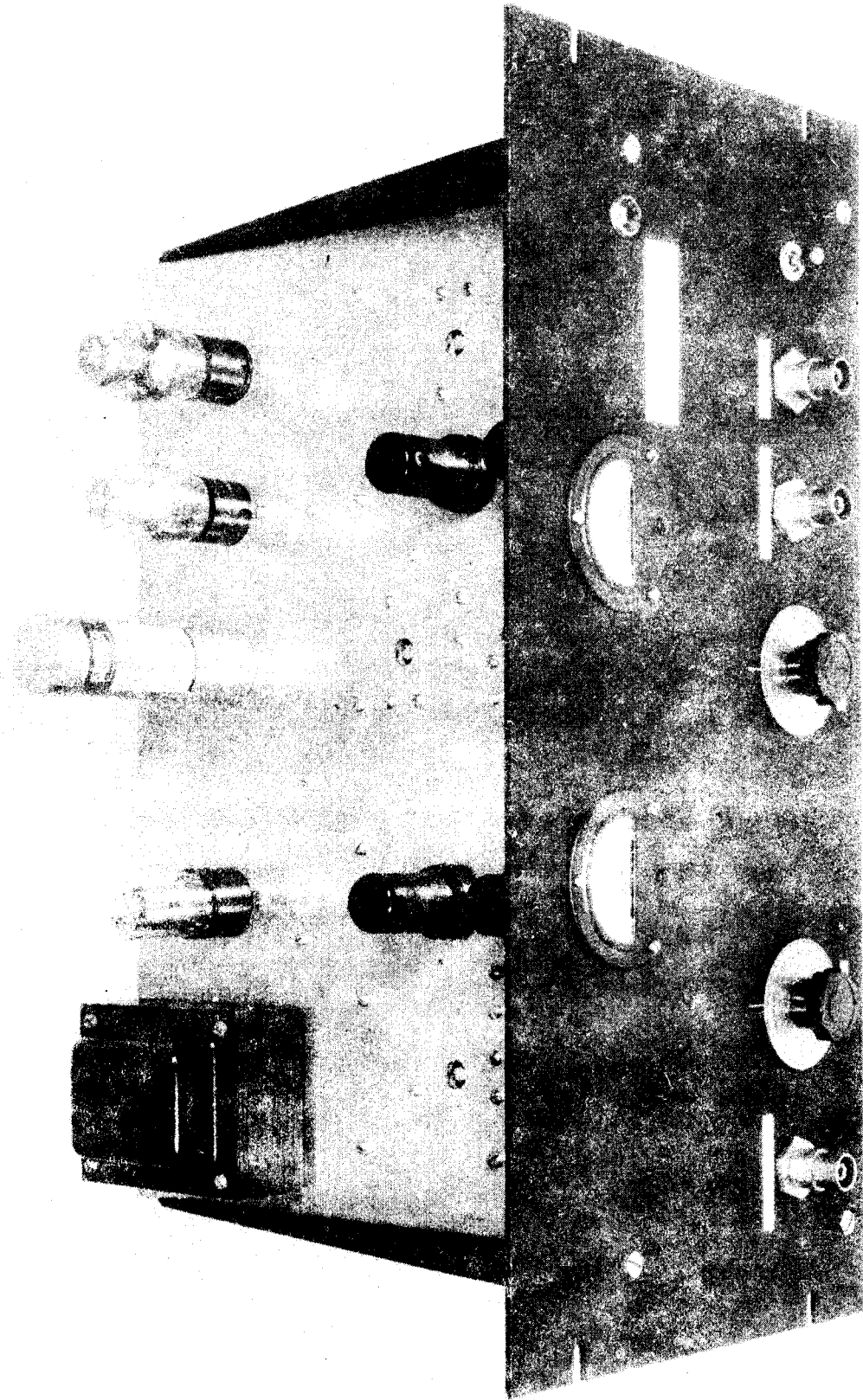

Fig. 14. FREQUENCY CONVERTER-MULTIPLIER; OUTPUT 28.5 TO 30.9 Mc/s (TOP FRONT VIEW).

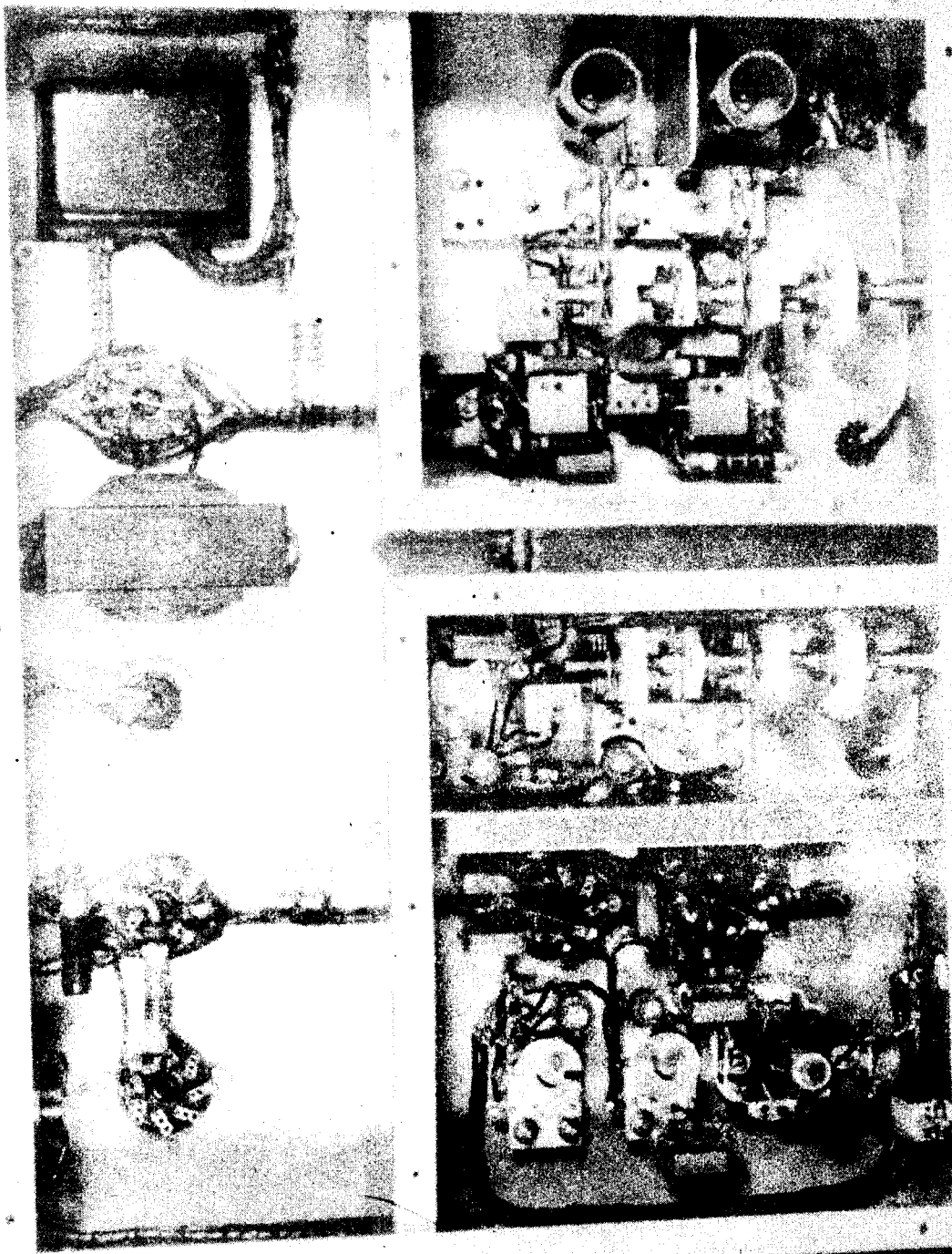

FIG. 15. FREQUENCY CONVERTER-MULTIPLIER; OUTPUT 28.5 TO 30.9 Mc/s (BOTTOM VIEW).

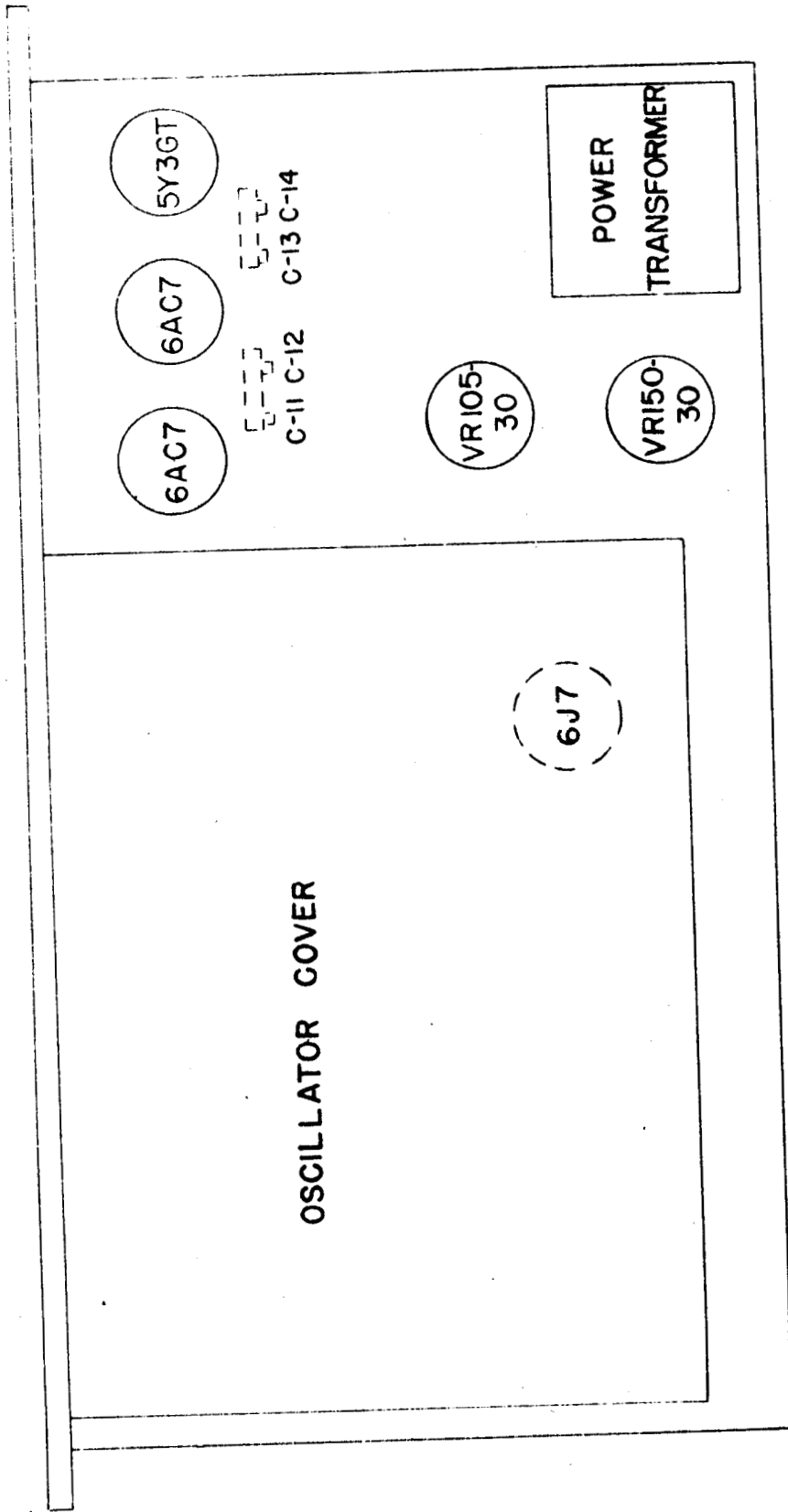
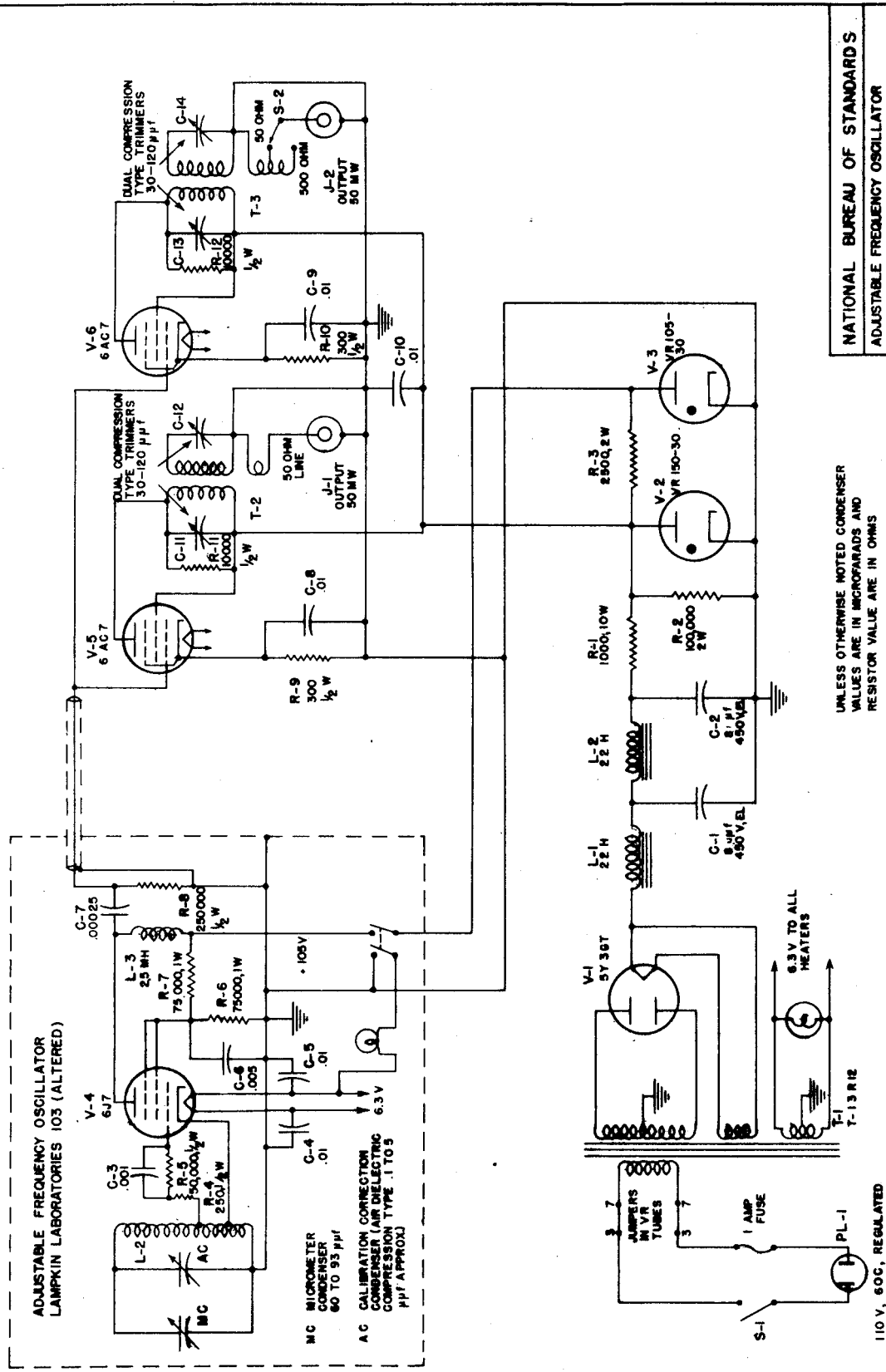

Fig. 16. LAYOUT DRAWING OF ADJUSTABLE-FREQUENCY
 OSCILLATOR; 2.0 TO 2.4 Mc/s AND 2.4 TO
 2.8 Mc/s

(TOP-REAR VIEW)



NATIONAL BUREAU OF STANDARDS
 ADJUSTABLE FREQUENCY OSCILLATOR
 FOR MICROWAVE FREQUENCY STANDARD
 OUTPUT: 2.0 TO 2.4 MC (SER. 192)
 2.4 TO 2.8 MC (SER. 114)
 B.L.T. BY: JMS (DR BY: JMS) DATE: 6-6-45
 APP. 1074
 DATE FEB. 46

UNLESS OTHERWISE NOTED CONDENSER
 VALUES ARE IN MICROFARADS AND
 RESISTOR VALUE ARE IN OHMS

FIG. 17

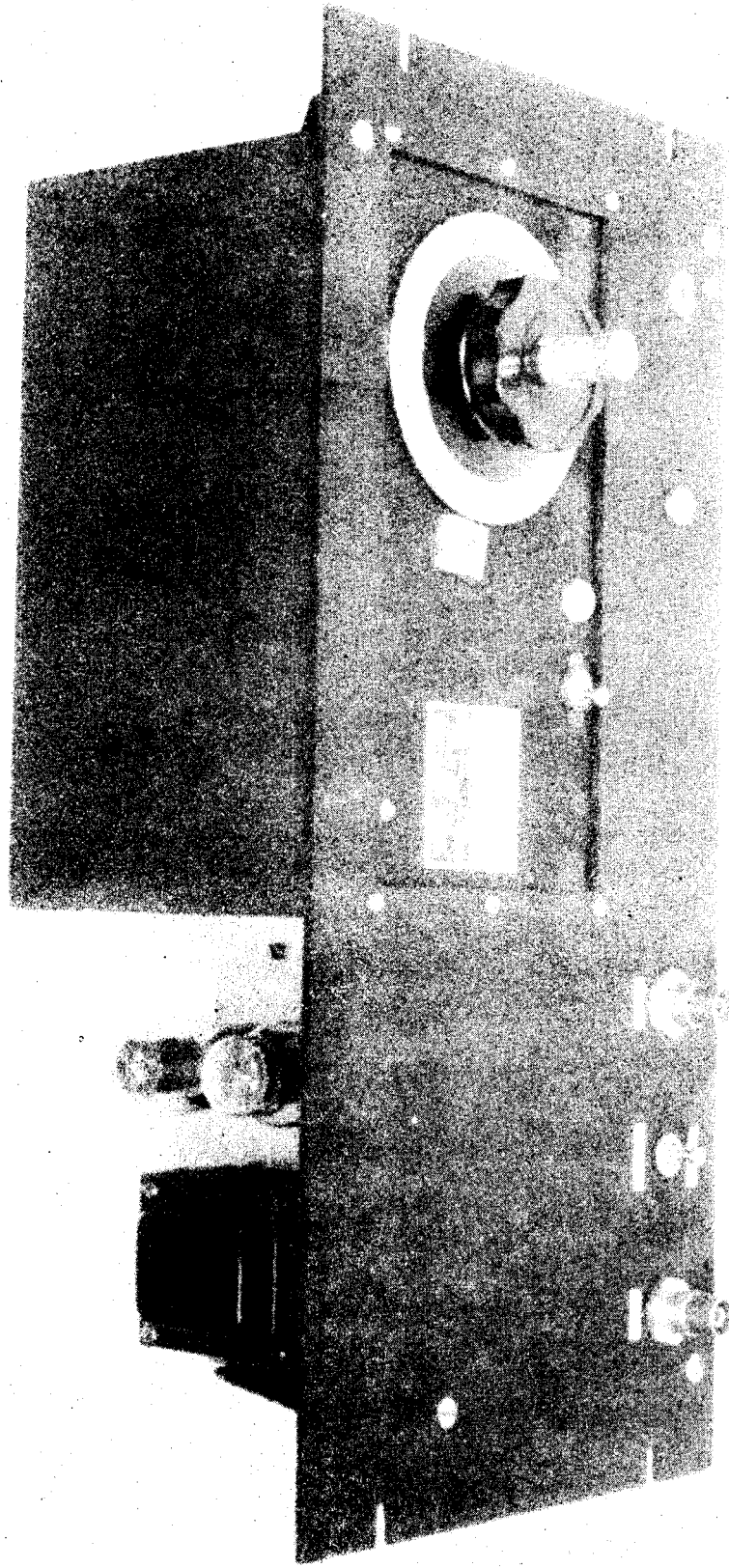

Fig. 18. ADJUSTABLE-FREQUENCY OSCILLATOR; 2.0 TO 2.4 Mc/s AND 2.4 TO 2.8 Mc/s
(TOP FRONT VIEW).

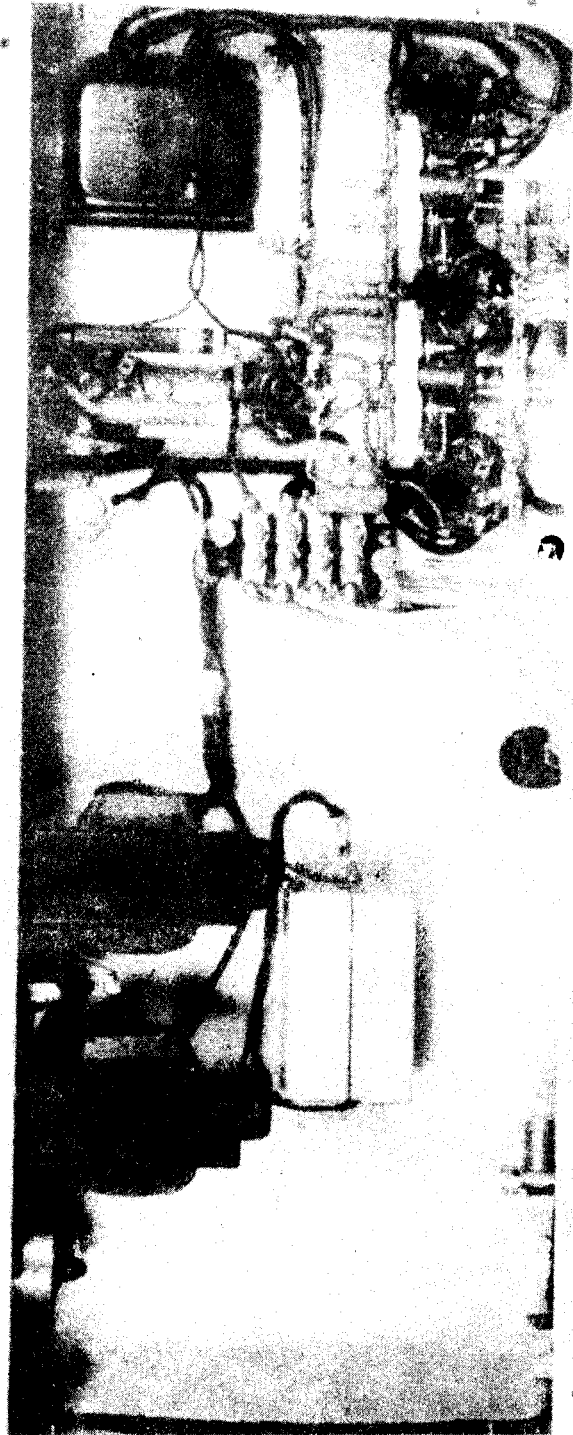

Fig. 19. ADJUSTABLE-FREQUENCY OSCILLATOR; 2.0 TO 2.4 Mc/s AND 2.4 TO 2.8 Mc/s
(BOTTOM VIEW).

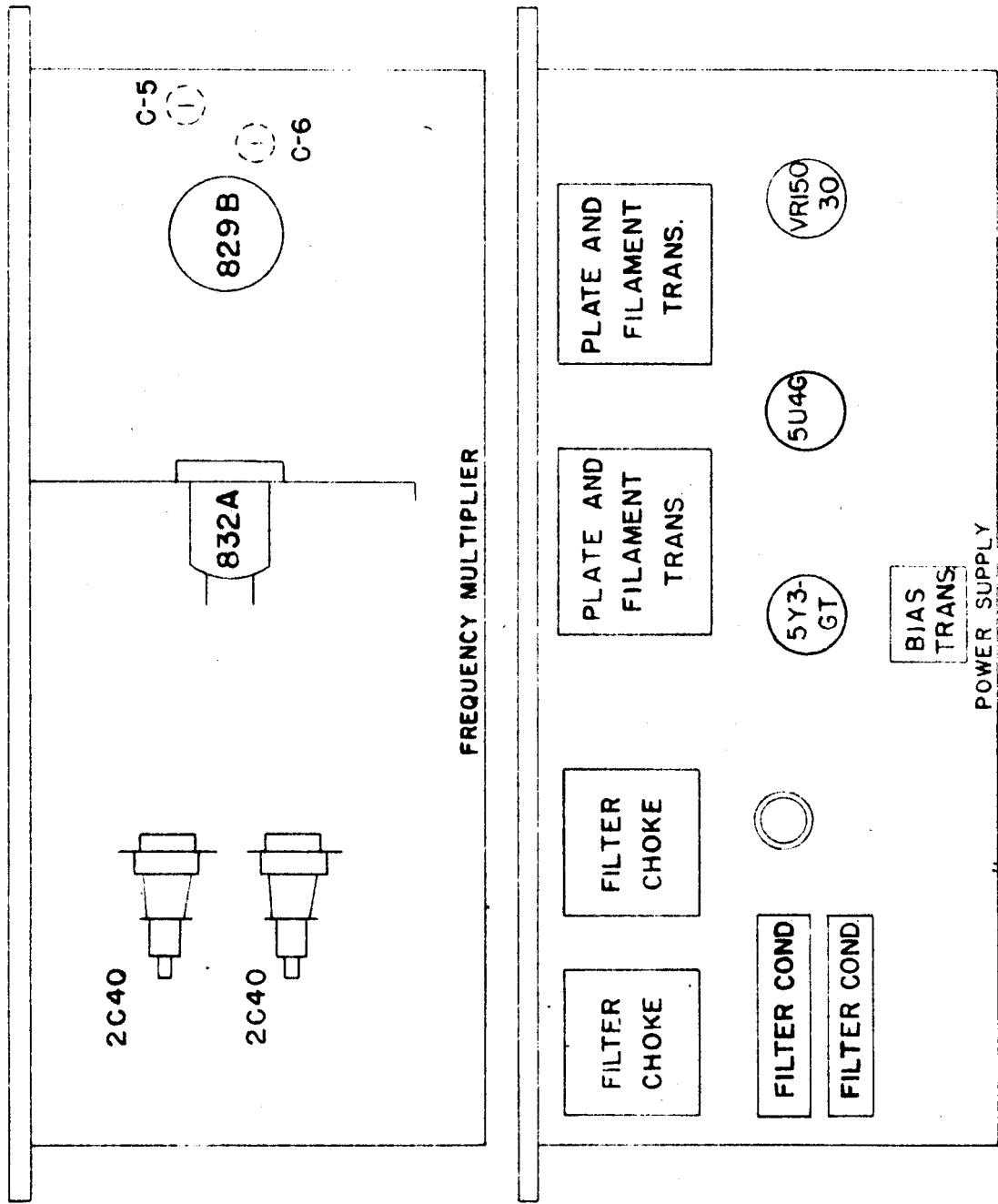
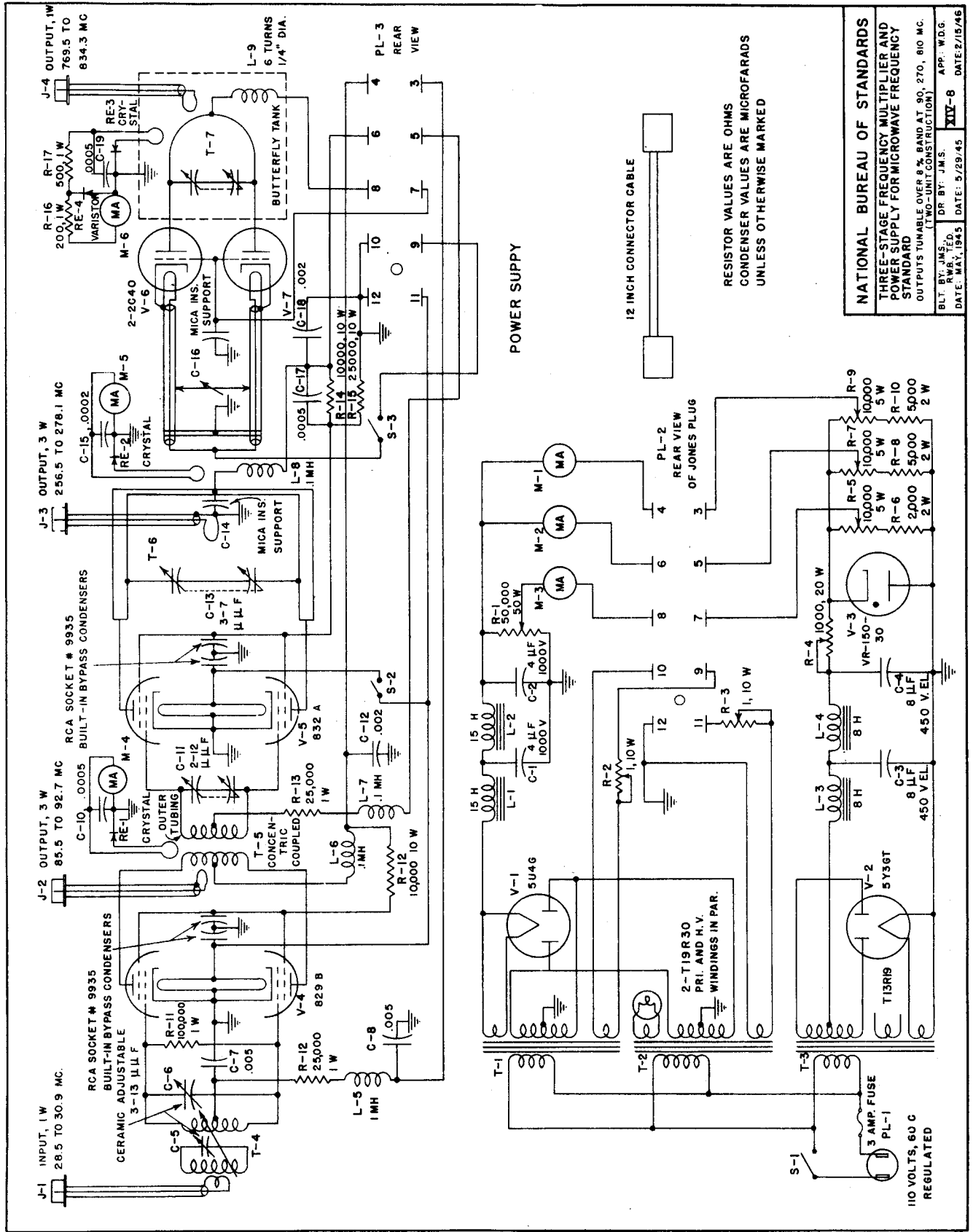

Fig. 20. LAYOUT DRAWING OF THREE-STAGE FREQUENCY MULTIPLIER AND POWER SUPPLY (TOP-REAR VIEWS)



NATIONAL BUREAU OF STANDARDS
THREE-STAGE FREQUENCY MULTIPLIER AND
POWER SUPPLY FOR MICROWAVE FREQUENCY
STANDARD
OUTPUTS TUNABLE OVER 8% BAND AT 90, 270, 810 MC.
BLT. BY: JMS. (11746-UNIT, CONSTRUCTION)
RWR. TED. DR. BY: JMS. APP. W.D.G.
DATE: MAY, 1945 DATE: 5/29/45 XIV-8 DATE: 2/15/46

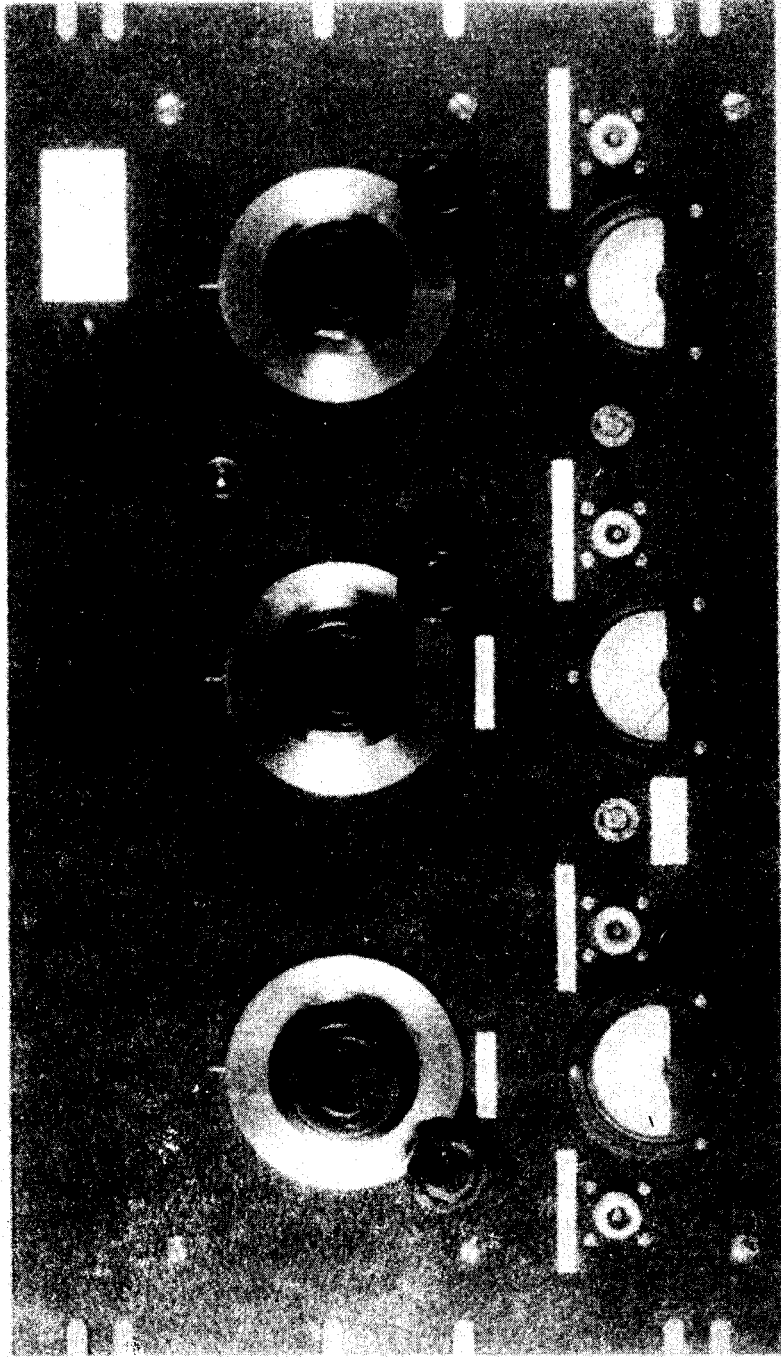

Fig. 22. THREE-STAGE FREQUENCY MULTIPLIER (FRONT VIEW).

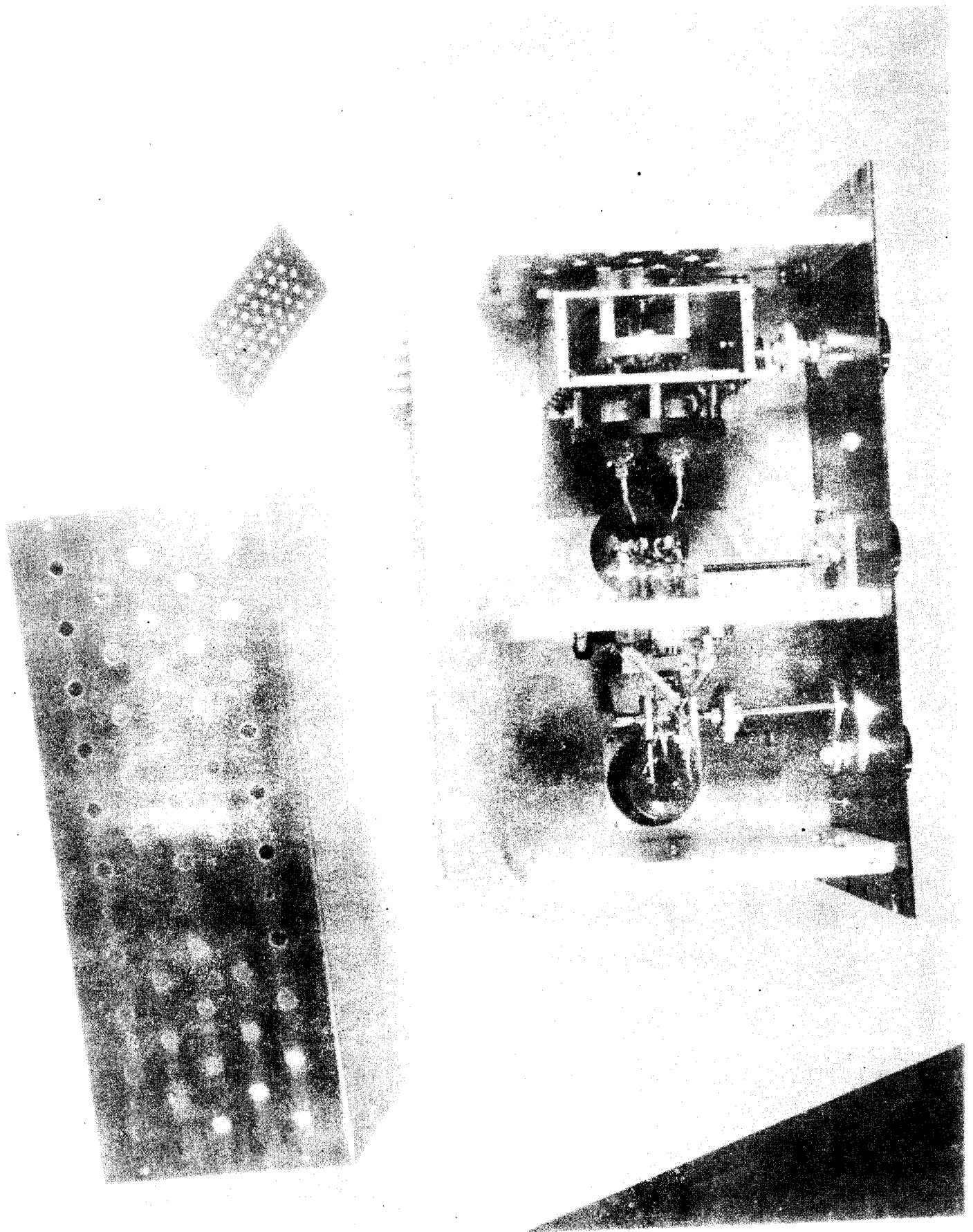

Fig. 23. THREE-STAGE FREQUENCY MULTIPLIER (TOP VIEW).

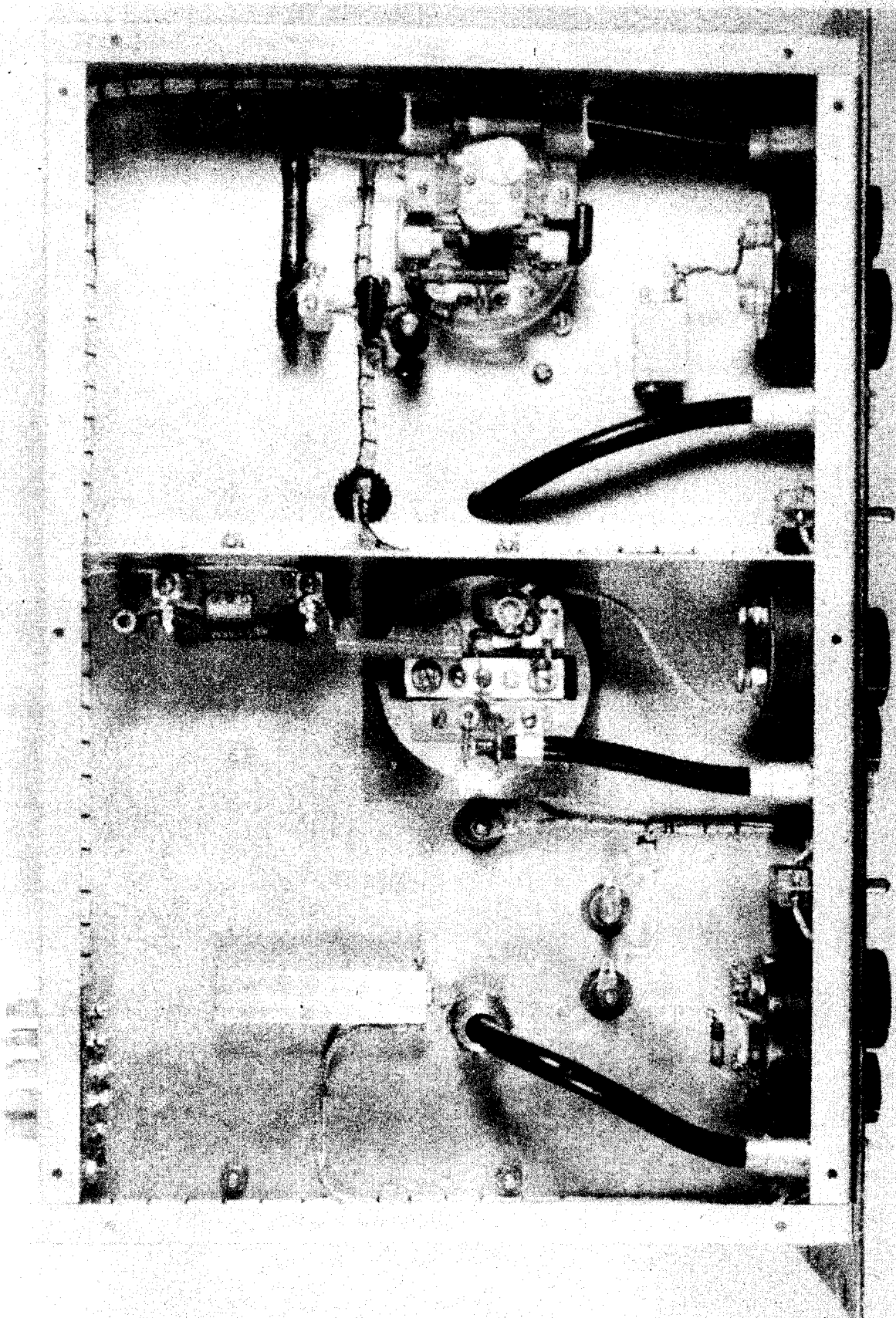

Fig. 24. THREE-STAGE FREQUENCY MULTIPLIER (BOTTOM VIEW).

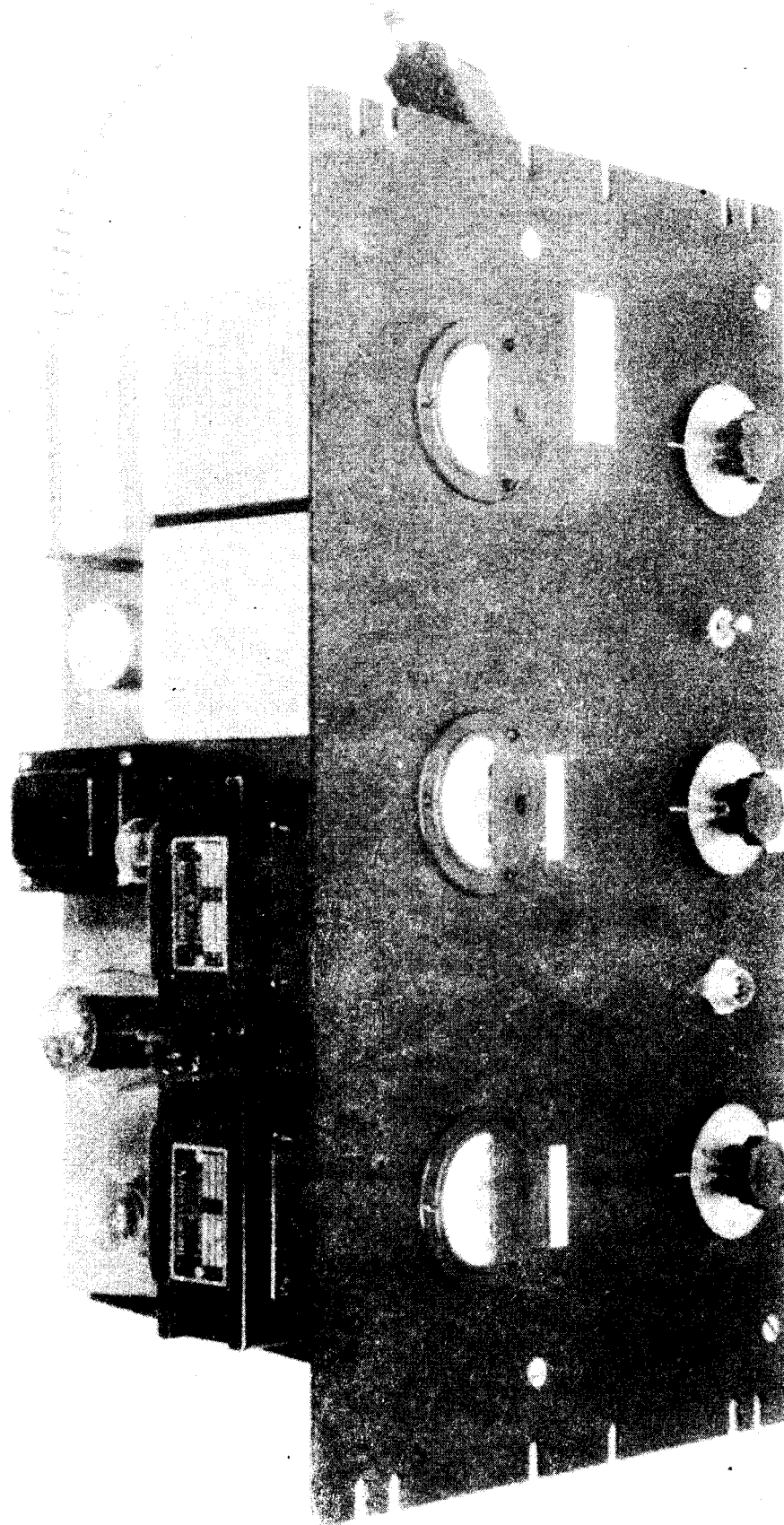

FIG. 25. POWER SUPPLY FOR THREE-STAGE FREQUENCY MULTIPLIER (TOP-FRONT VIEW).

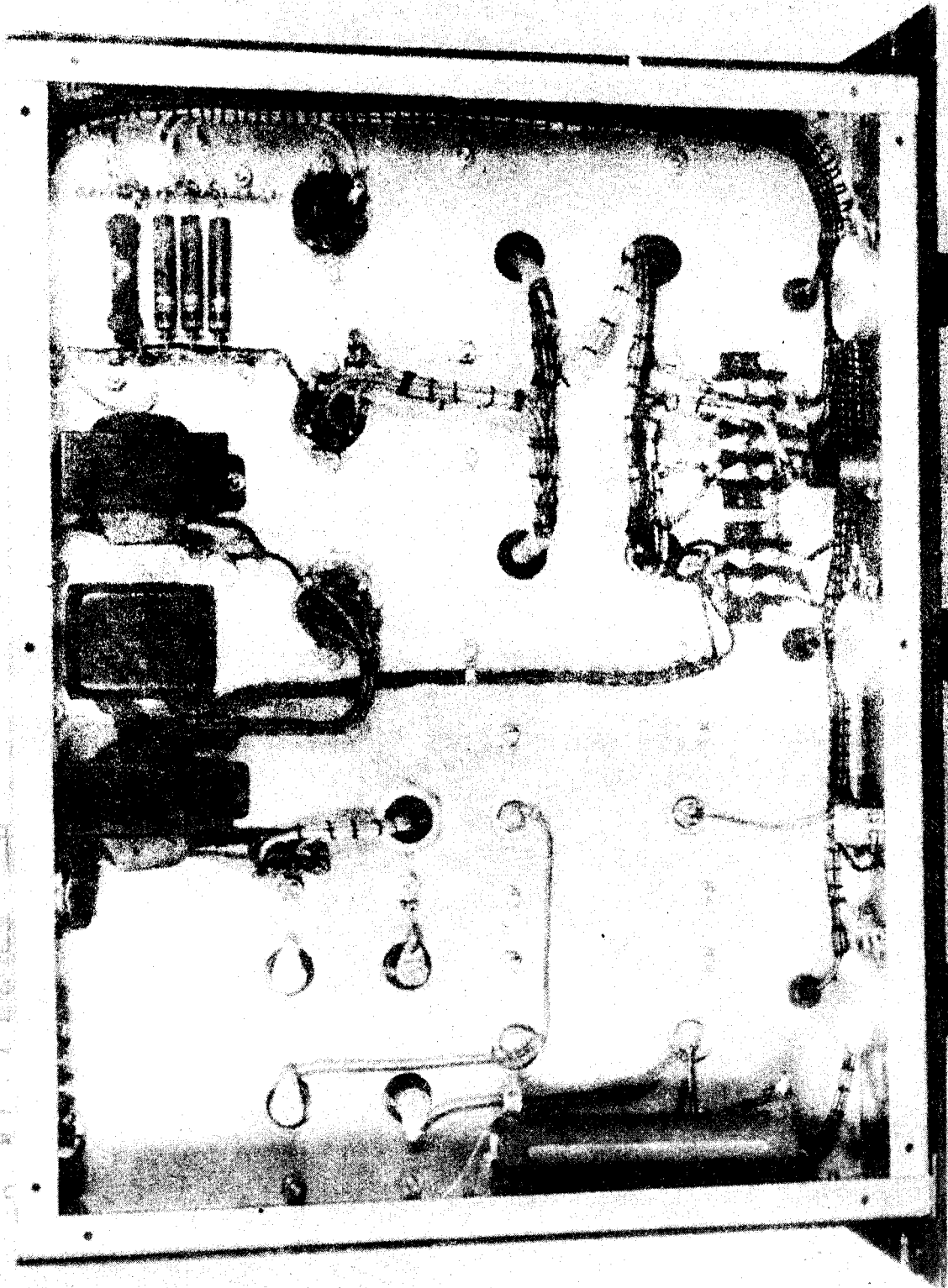

Fig. 26 POWER SUPPLY FOR THREE-STAGE FREQUENCY MULTIPLIER (BOTTOM VIEW)

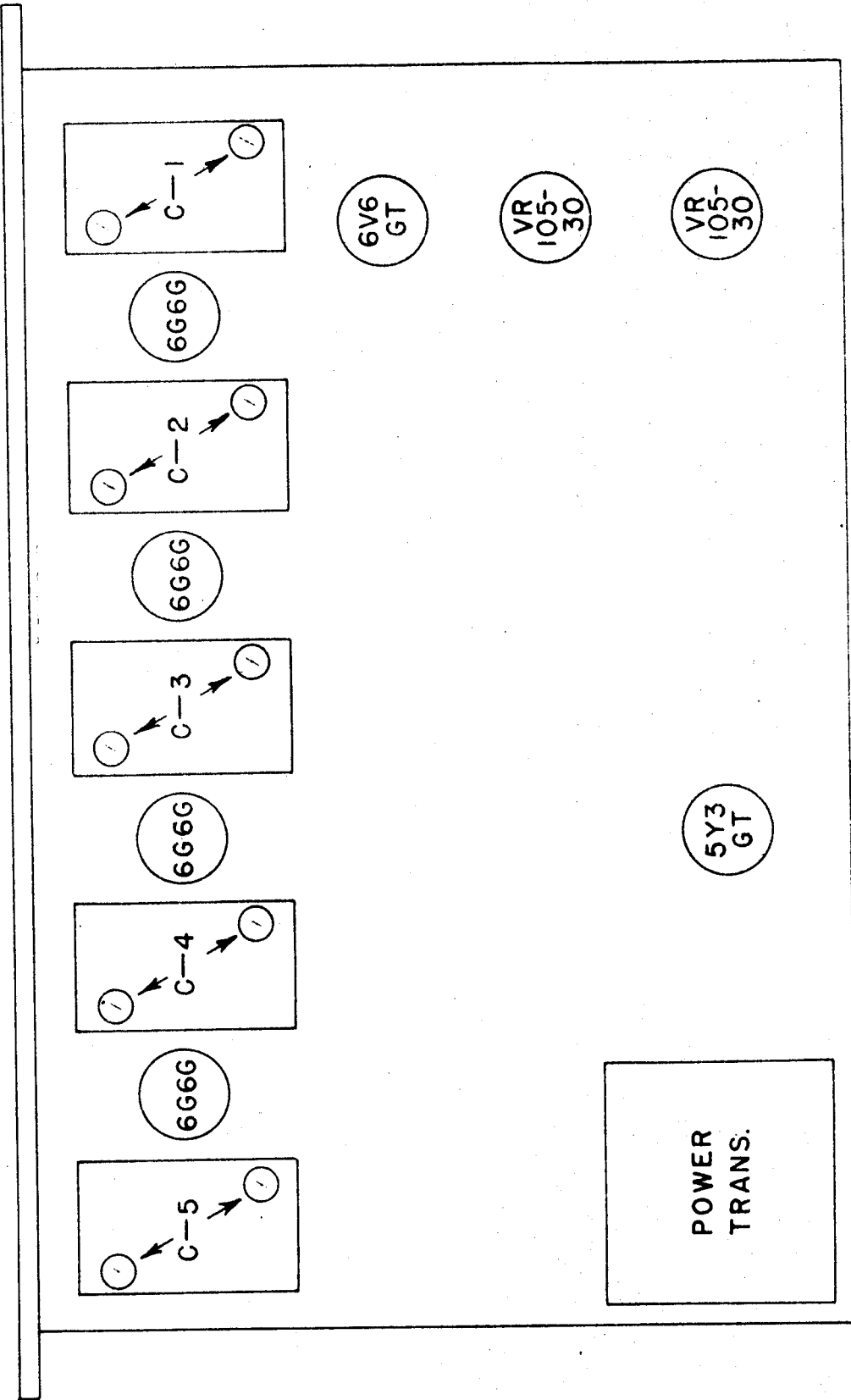
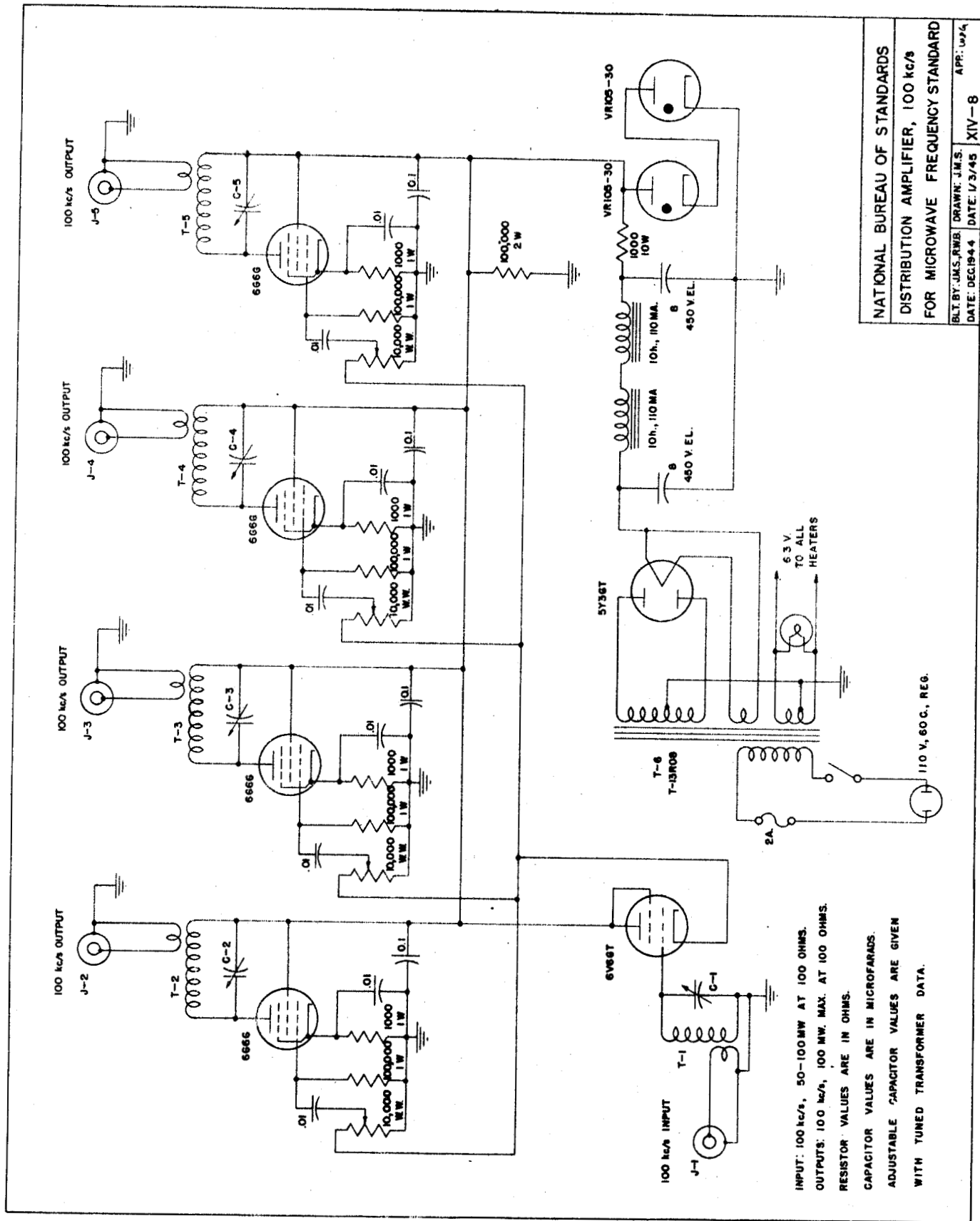

FIG. 27. LAYOUT DRAWING OF DISTRIBUTION AMPLIFIER; 100 kc/s. (TOP-REAR VIEW).



INPUT: 100 kc/s, 50-100 MW AT 100 OHMS.
 OUTPUTS: 100 kc/s, 100 MW. MAX. AT 100 OHMS.
 RESISTOR VALUES ARE IN OHMS.
 CAPACITOR VALUES ARE IN MICROFARADS.
 ADJUSTABLE CAPACITOR VALUES ARE GIVEN
 WITH TUNED TRANSFORMER DATA.

NATIONAL BUREAU OF STANDARDS
 DISTRIBUTION AMPLIFIER, 100 kc/s
 FOR MICROWAVE FREQUENCY STANDARD
 B.L.T. BY: J.M.S./R.W.B. DRAWN: J.M.S.
 DATE: DEC 1944 DATE: 1/3/45 APR: 1945
 XIV-8

FIG. 28

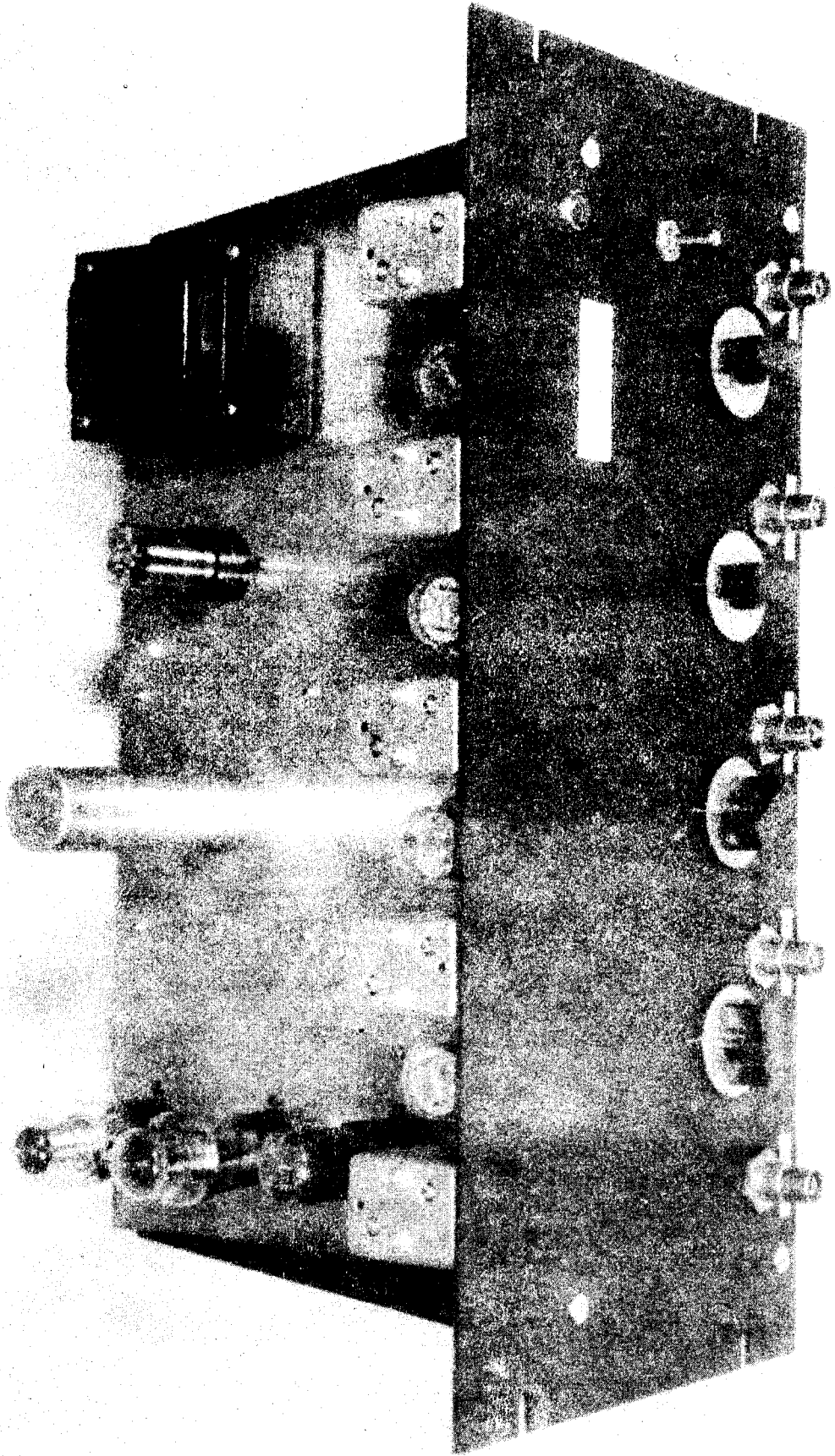

Fig. 29 DISTRIBUTION AMPLIFIER: 100 kc/s (TOP FRONT VIEW).

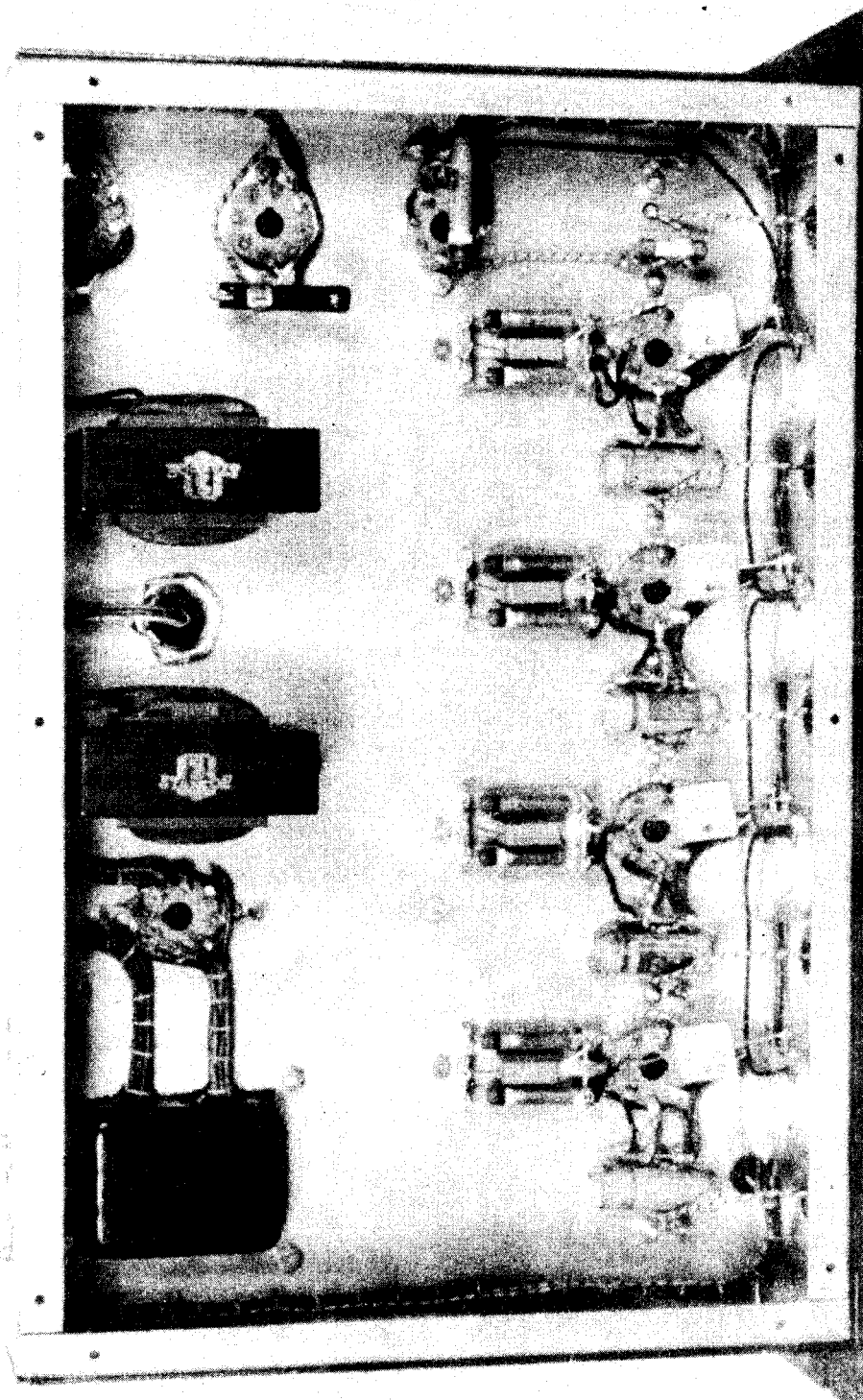

Fig. 30 DISTRIBUTION AMPLIFIER; 100 kc/s (BOTTOM VIEW).

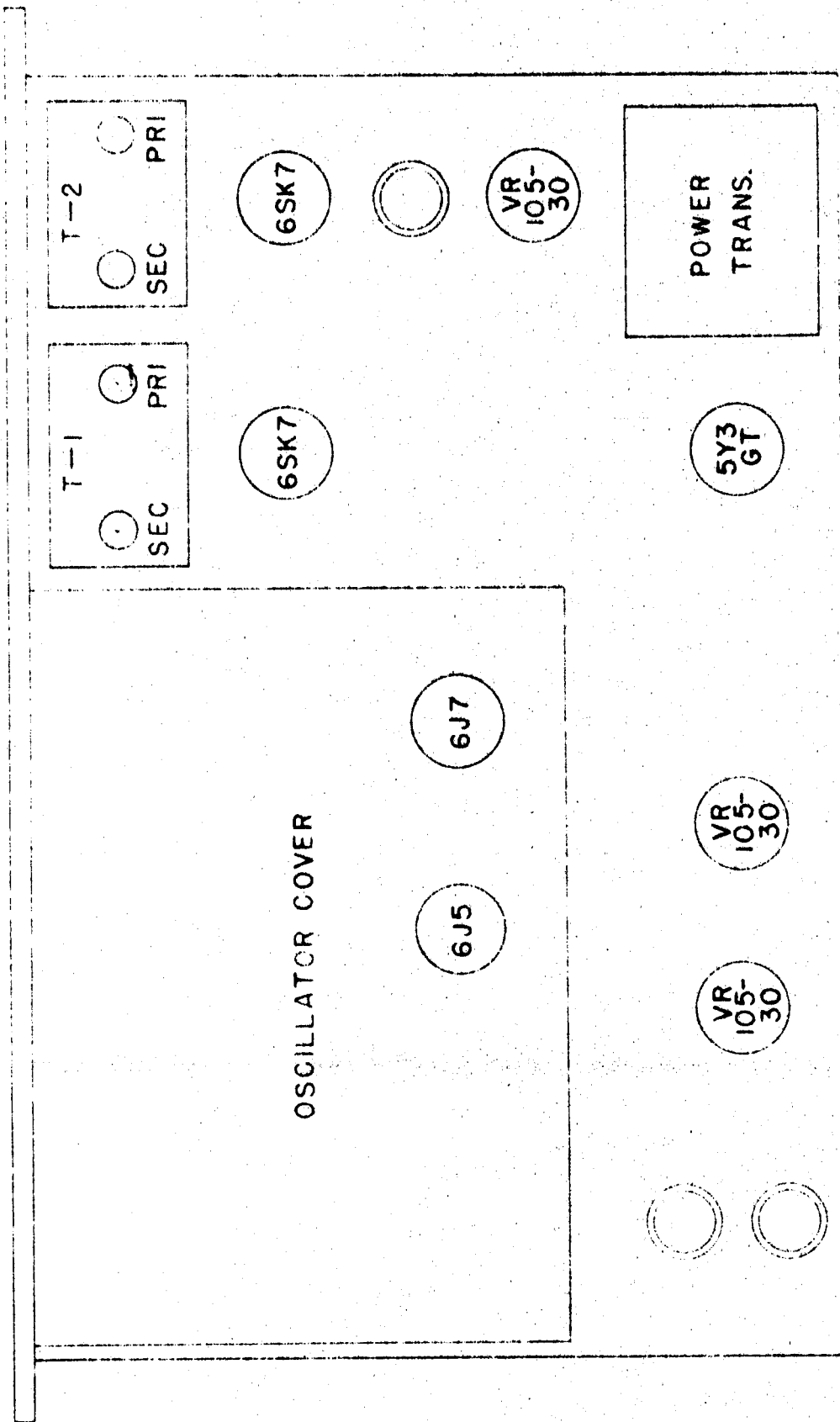
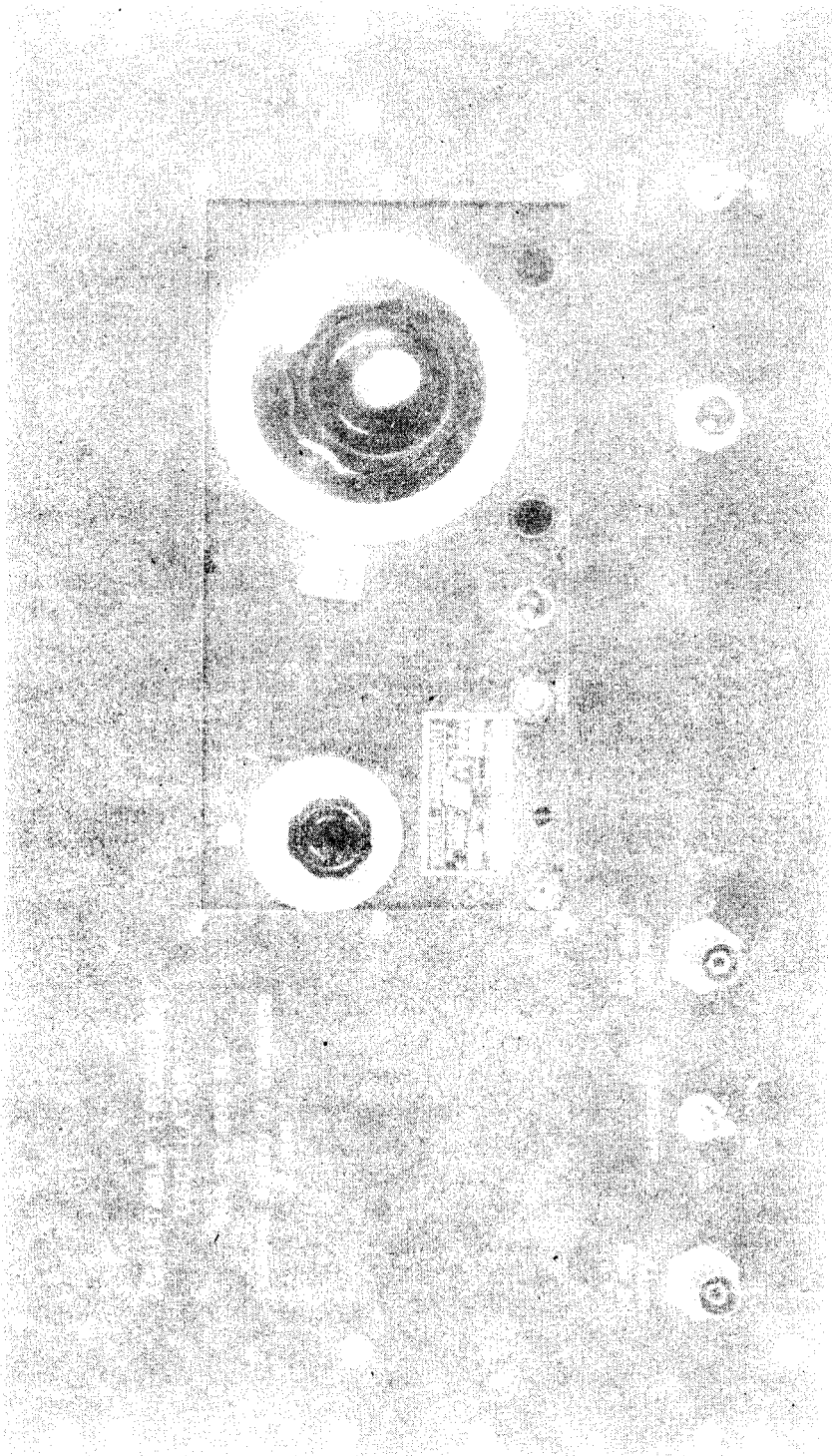

FIG. 31. LAYOUT DRAWING OF ADJUSTABLE-FREQUENCY OSCILLATOR, 500 TO 600 kc/s. (TOP-REAR VIEW).



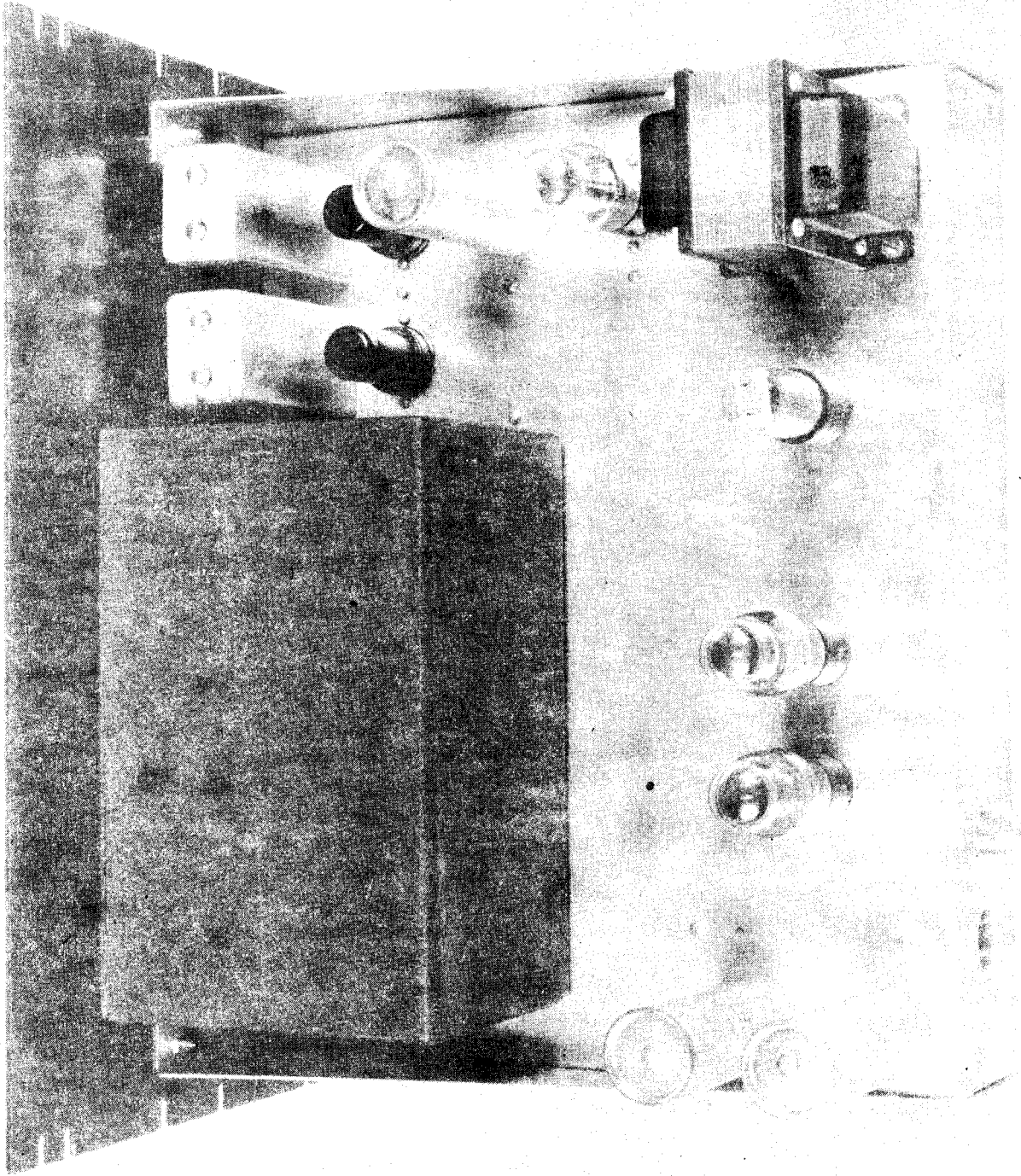

FIG. 24. JUSTABLE-FREQUENCY OSCILLATOR; 500 TO 600 kc/s (TOP VIEW).

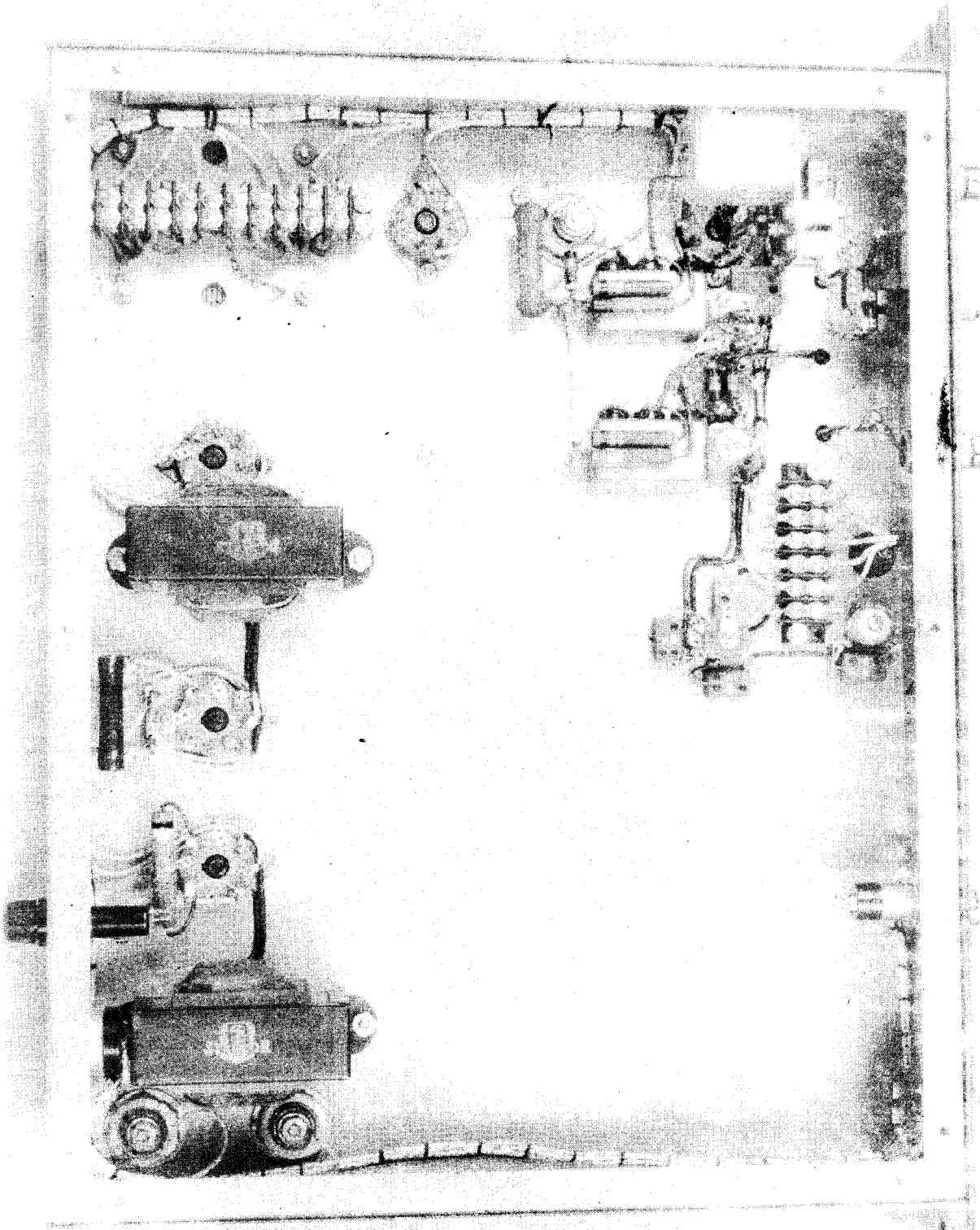

Fig. 35. ADJUSTABLE FREQUENCY OSCILLATOR; 500 TO 600 KC/S (BOTTOM VIEW).

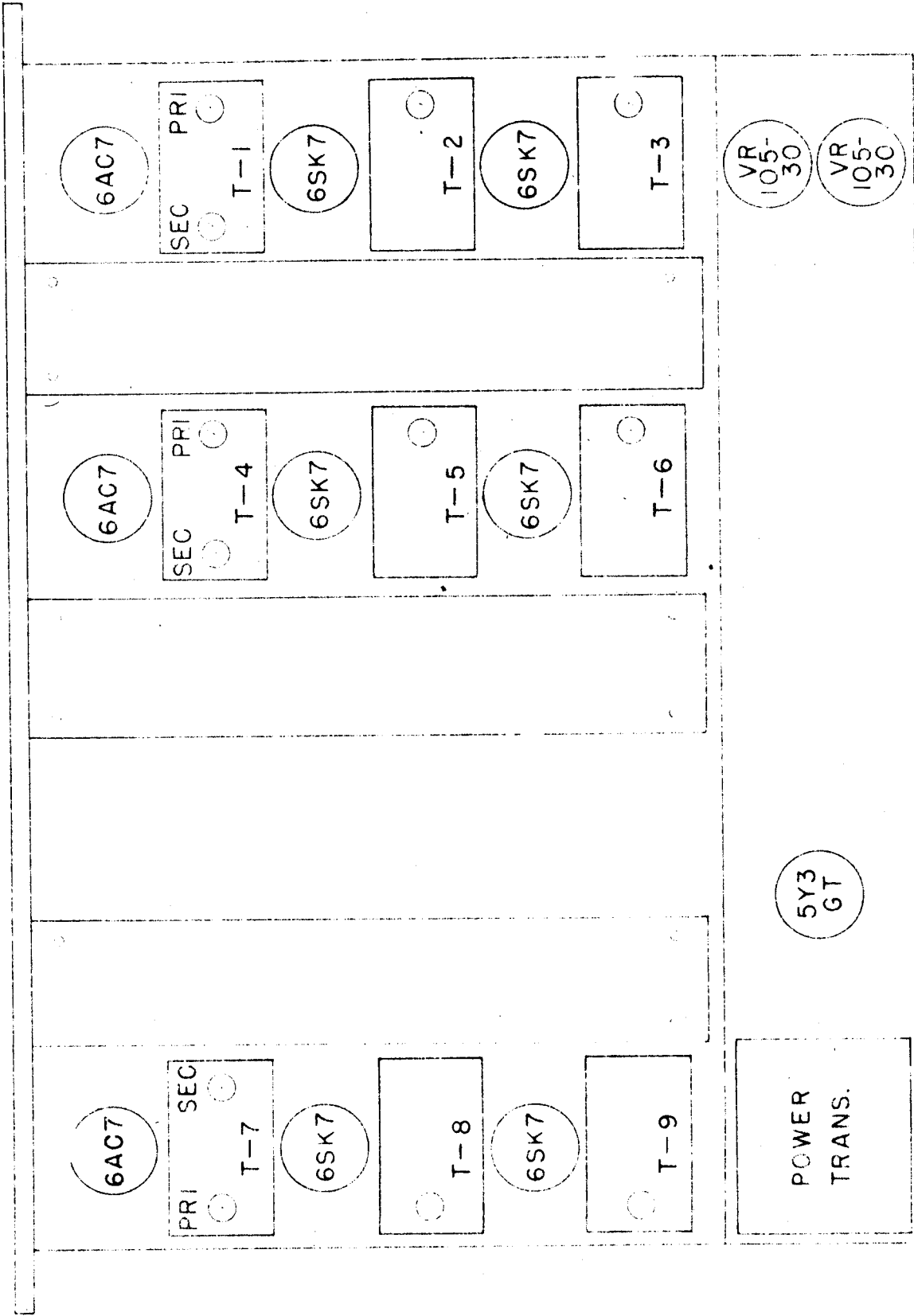
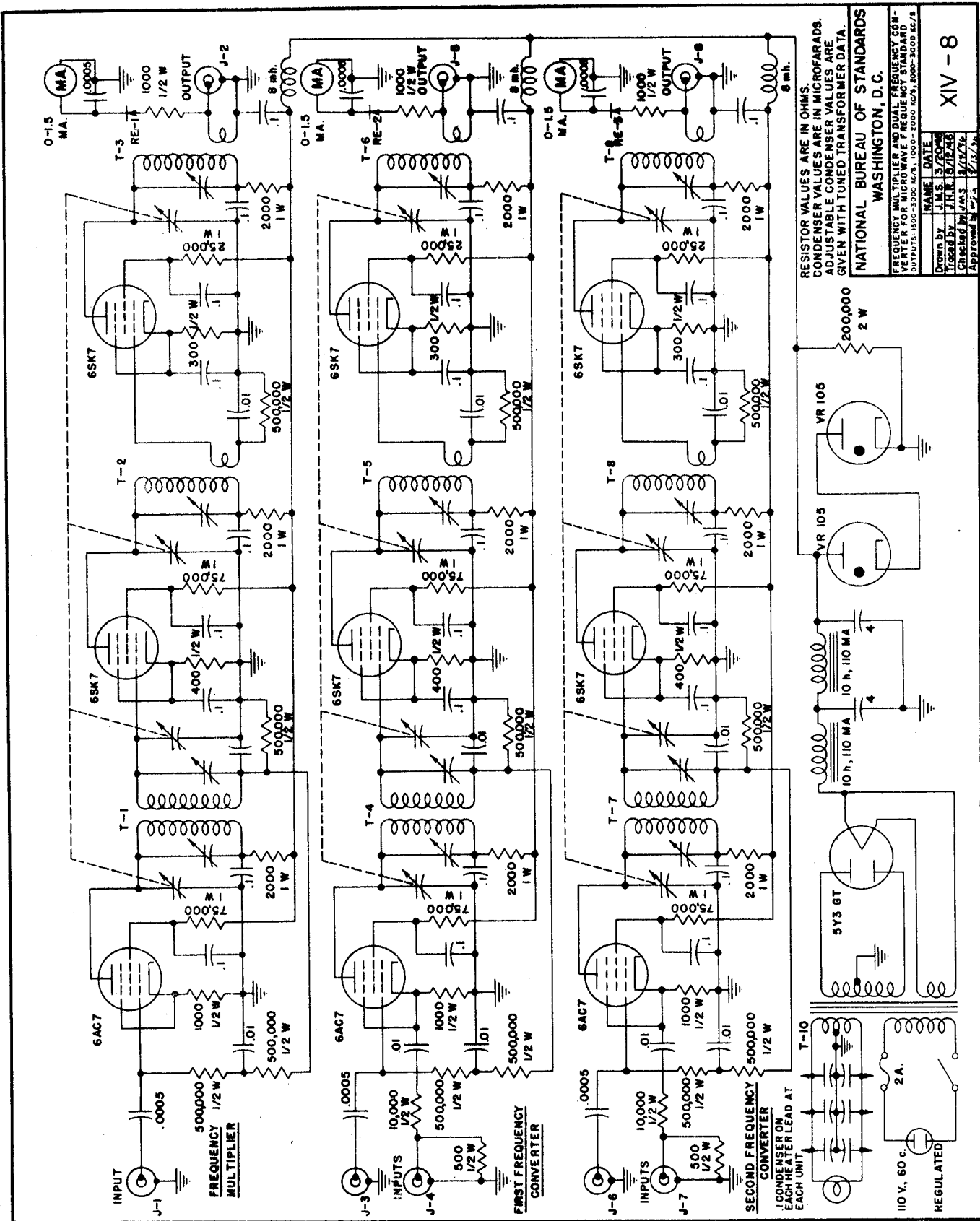

FIG. 76. LAYOUT DRAWING OF FREQUENCY MULTIPLIER AND DUAL FREQUENCY CONVERTER; OUTPUTS: 1500 TO 3000 kc/s, 1000 TO 2000 kc/s, 2000 TO 3000 kc/s (TOP-REAR VIEW).



RESISTOR VALUES ARE IN OHMS.
 CONDENSER VALUES ARE IN MICROFARADS.
 ADJUSTABLE CONDENSER VALUES ARE
 GIVEN WITH TUNED TRANSFORMER DATA.

NATIONAL BUREAU OF STANDARDS
 WASHINGTON, D. C.

NAME	DATE
Drawn by J.M.S. 3/20/48	
Traceed by J.H.K. 8/12/48	
Checked by J.m.s. 9/12/48	
Approved by W.S. 2/12/49	

XIV - 8

FIG. 37

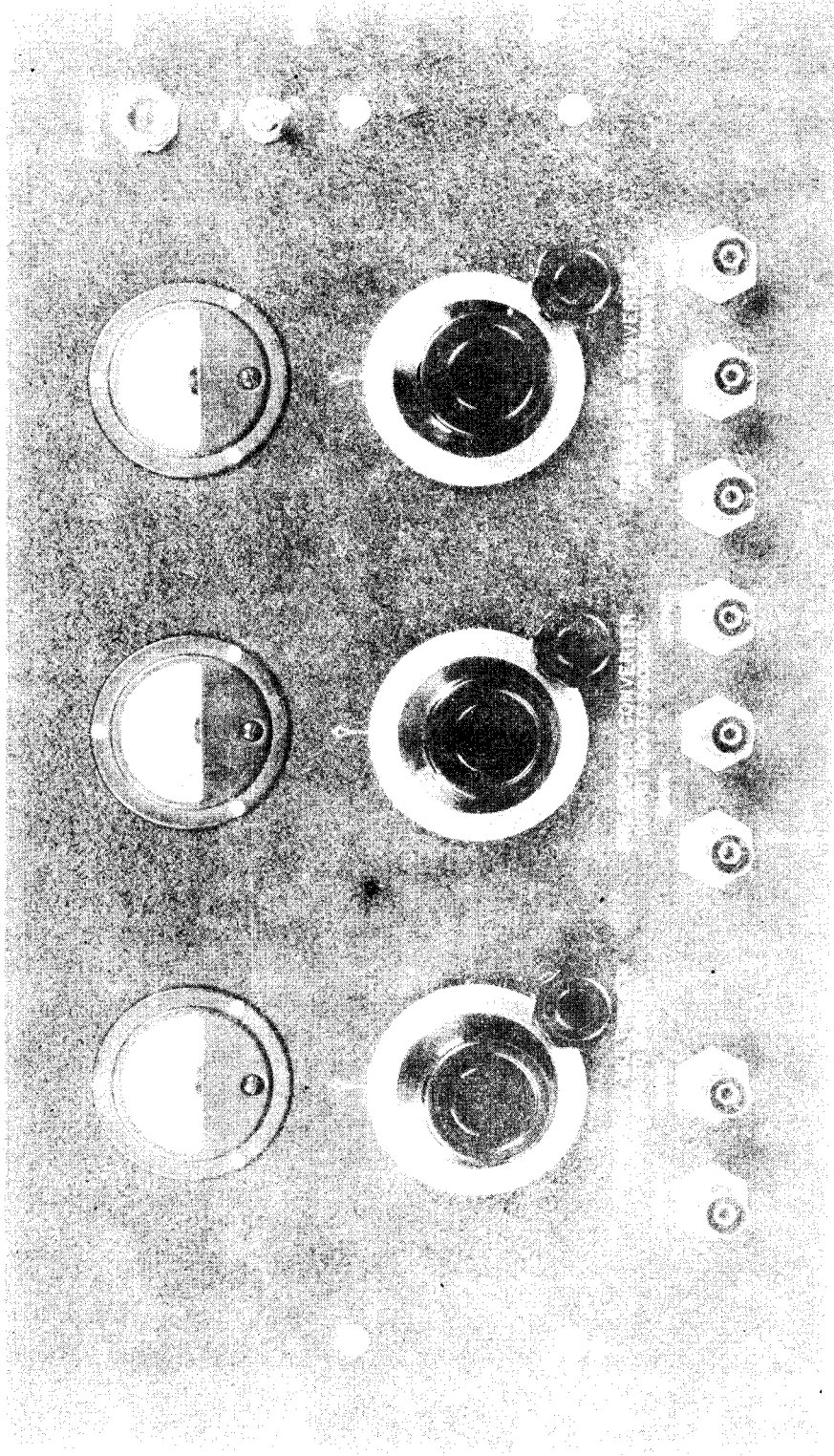

FIG. 10. FREQUENCY MULTIPLIER AND DUAL FREQUENCY CONVERTER (FRONT VIEW).

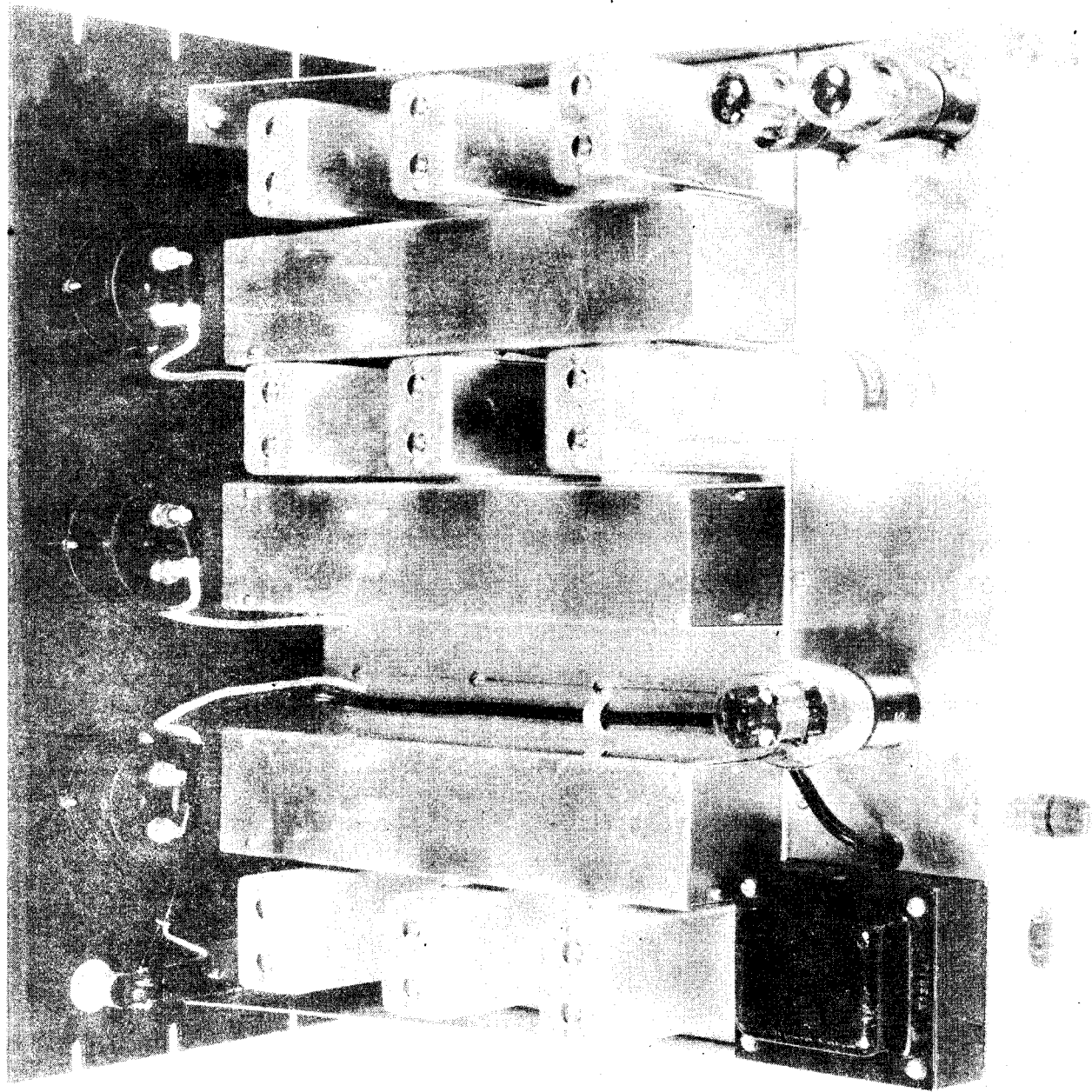

Fig. 39. FREQUENCY MULTIPLIER AND DUAL FREQUENCY CONVERTER (TOP VIEW)

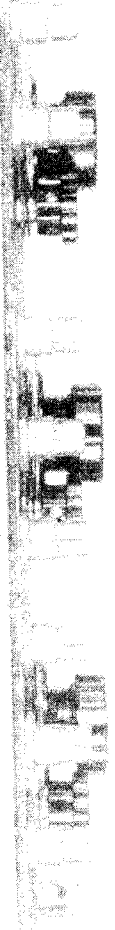
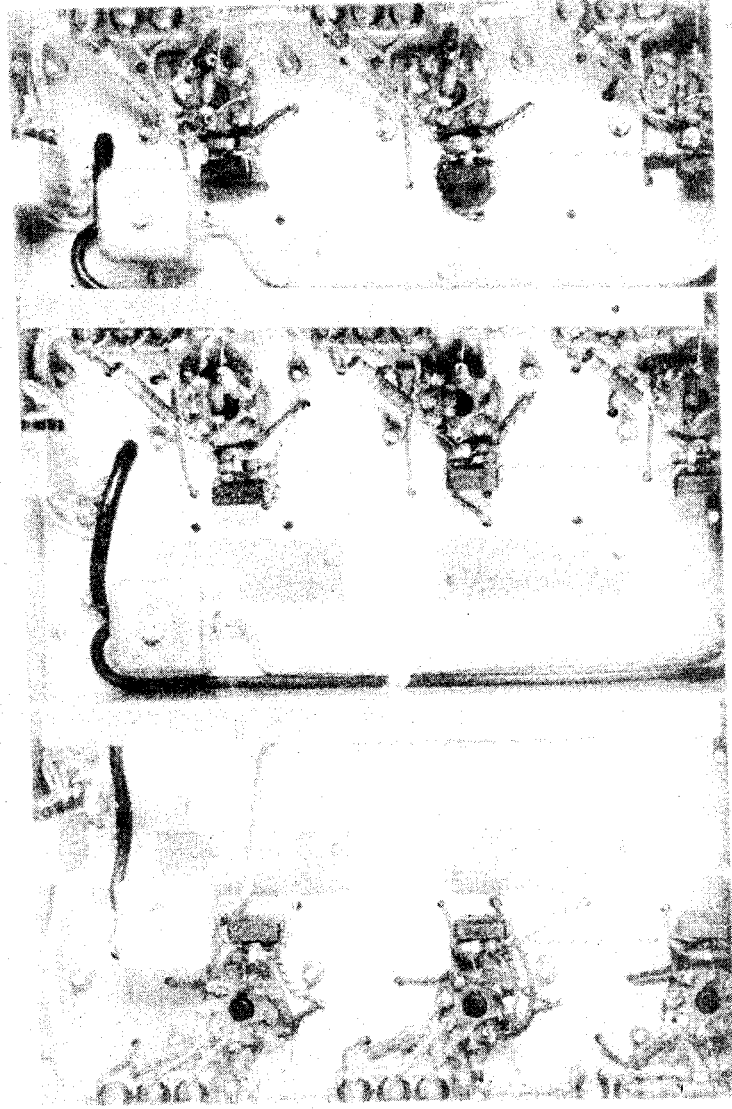
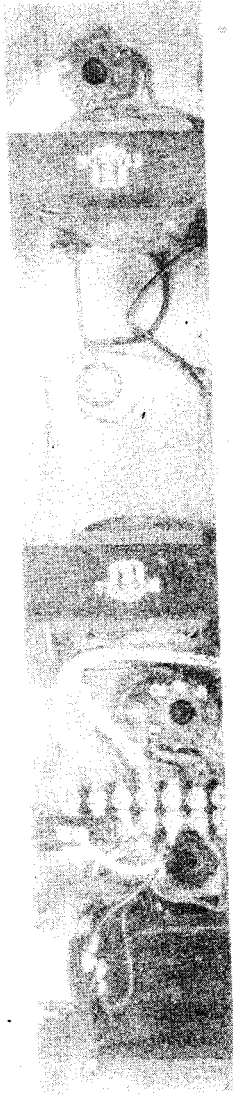

FIG. 40. FREQUENCY MULTIPLIER AND DUAL FREQUENCY CONVERTER (BOTTOM VIEW).

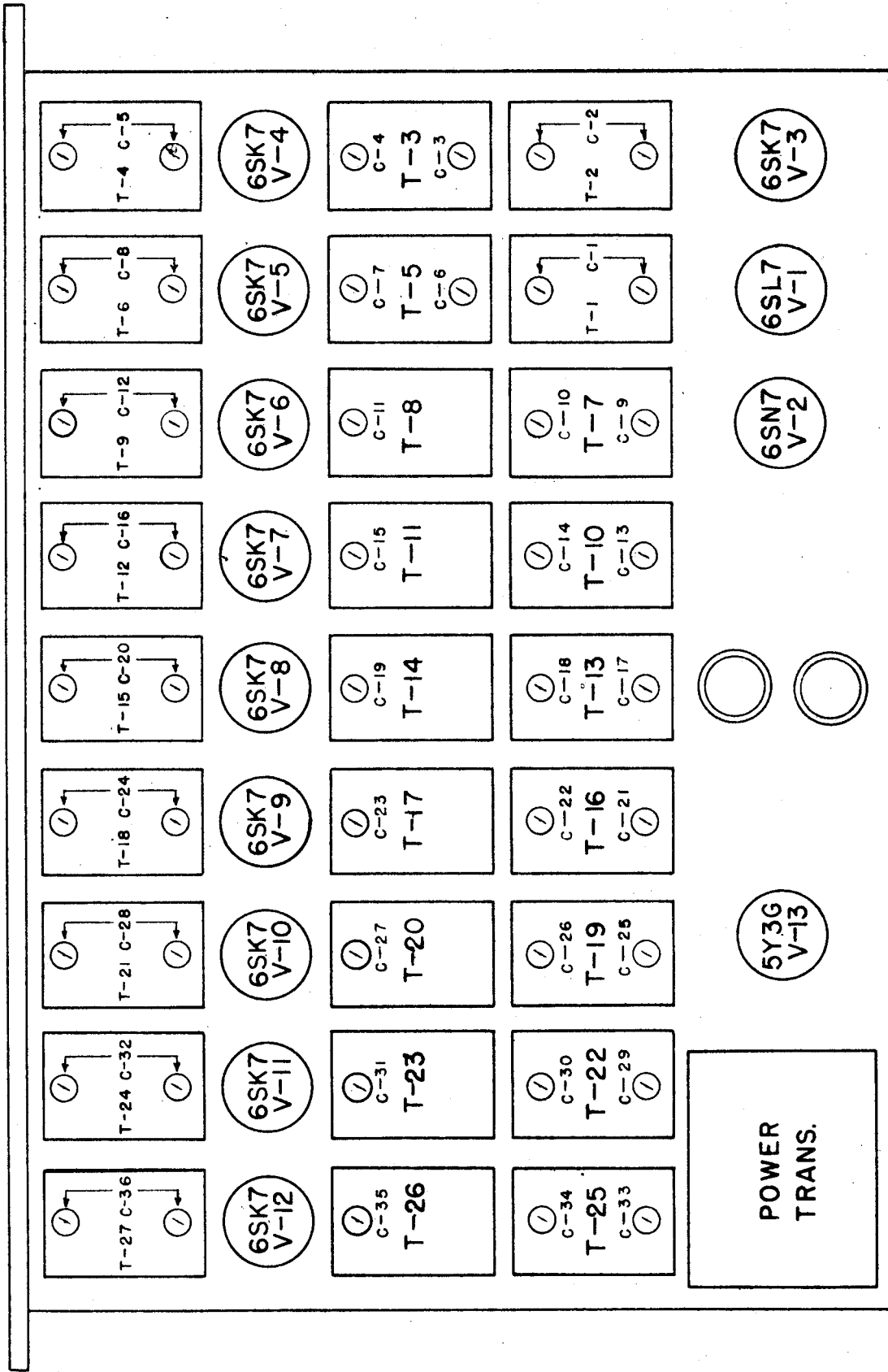
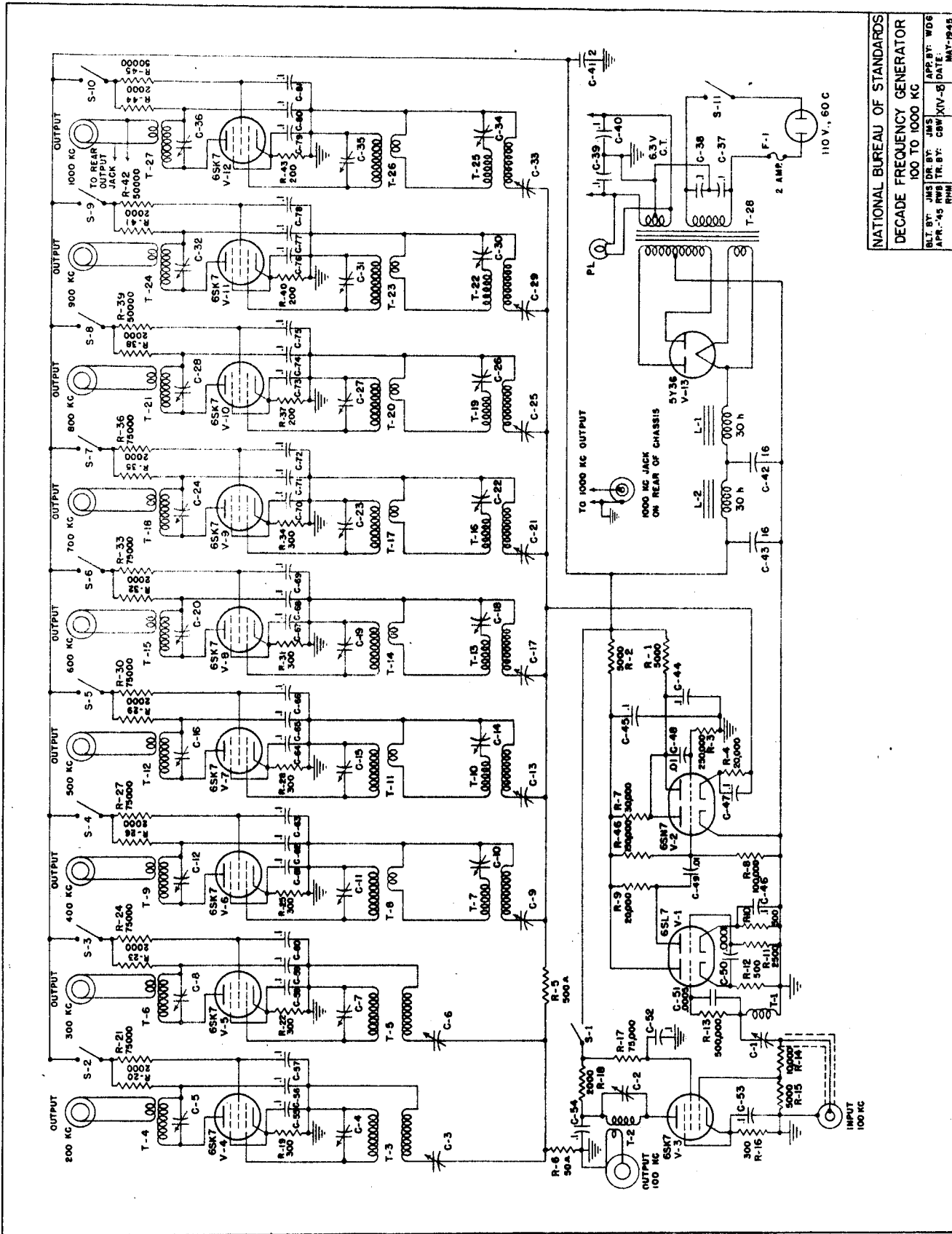

FIG. 41. LAYOUT DRAWING OF DECADE FREQUENCY GENERATOR;
 OUTPUTS AT 100*kc INTERVALS FROM 100 TO 1000 kc/s.
 (TOP - REAR VIEW)



NATIONAL BUREAU OF STANDARDS
 DECADE FREQUENCY GENERATOR
 100 TO 1000 KC
 SLT BY: JMS (DR BY: JMS) APR 57: WD6
 APR-45 PWS TR BY: GSW (XV-5) DATE: MAY-1945
 RHM

FIG. 42

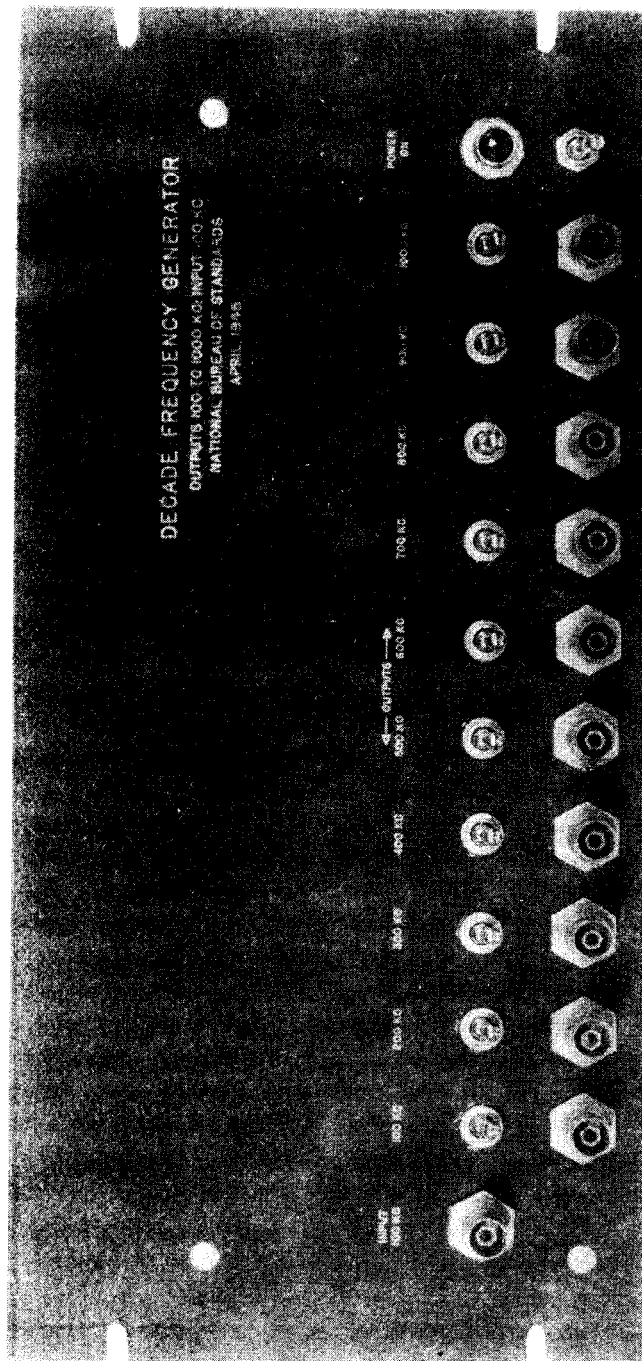

Fig. 43. DECADE FREQUENCY GENERATOR (FRONT VIEW).

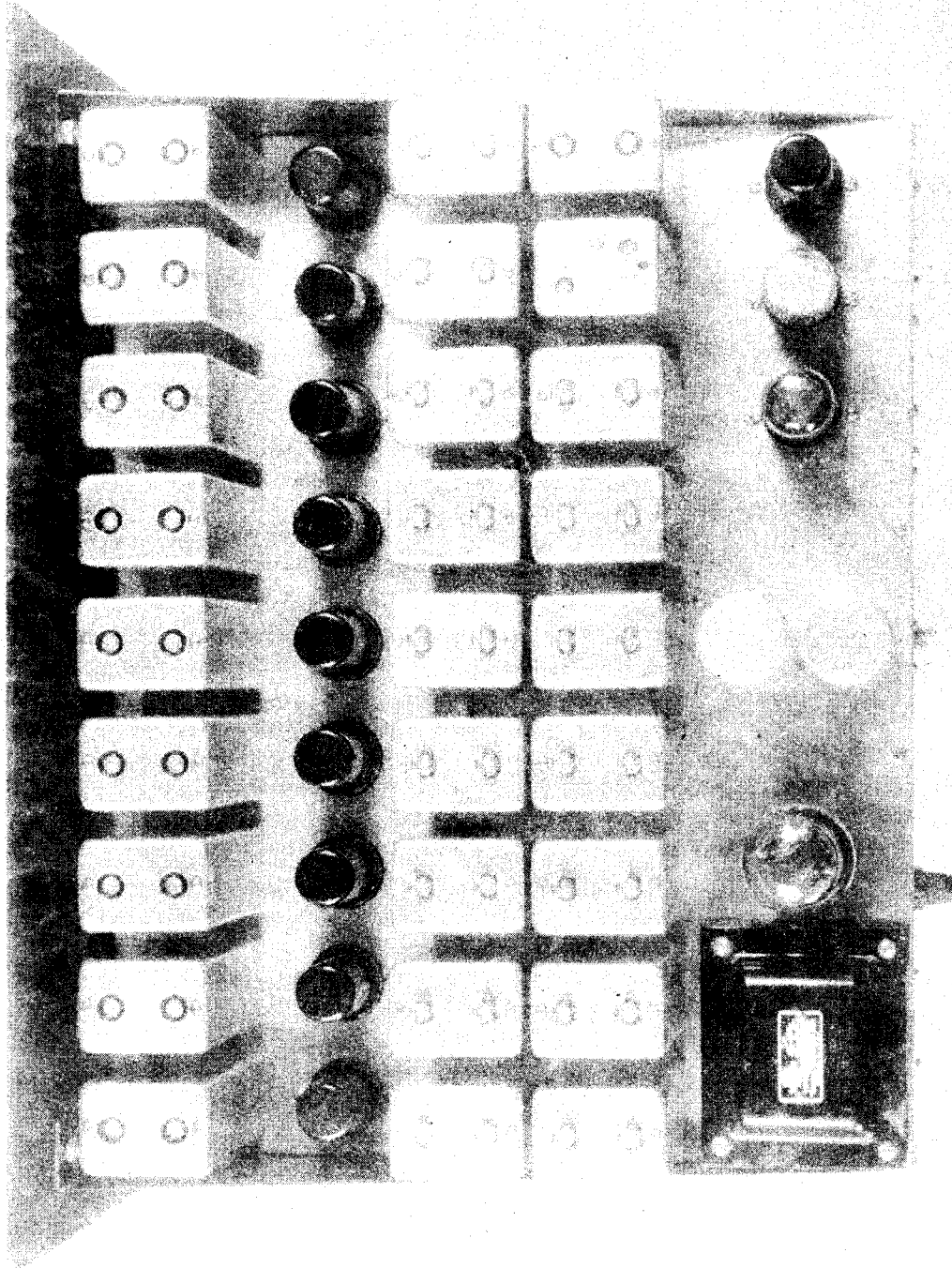

Fig. 44. DECADE FREQUENCY GENERATOR (TOP VIEW).

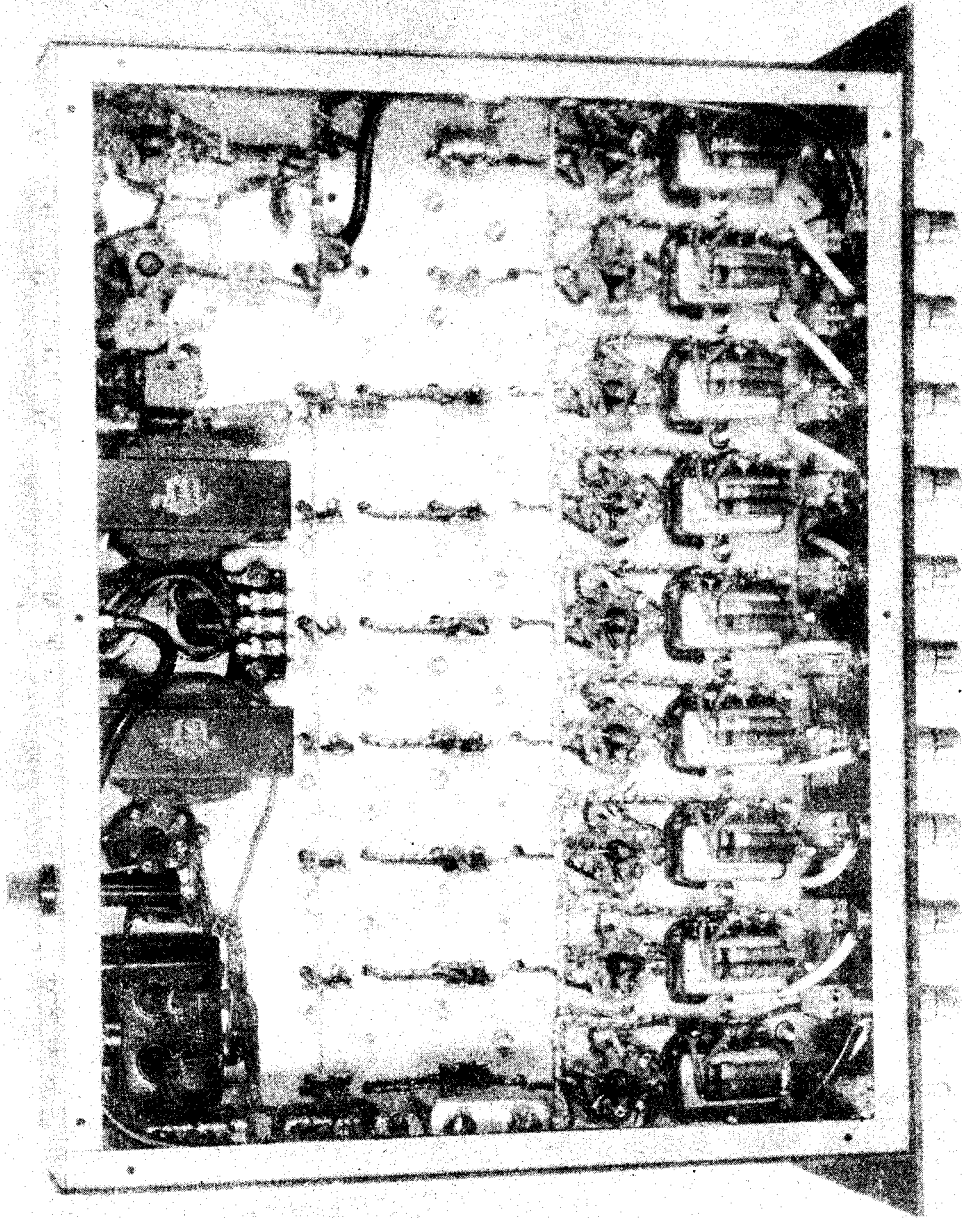

FIG. 45. DECADE FREQUENCY GENERATOR (BOTTOM VIEW).

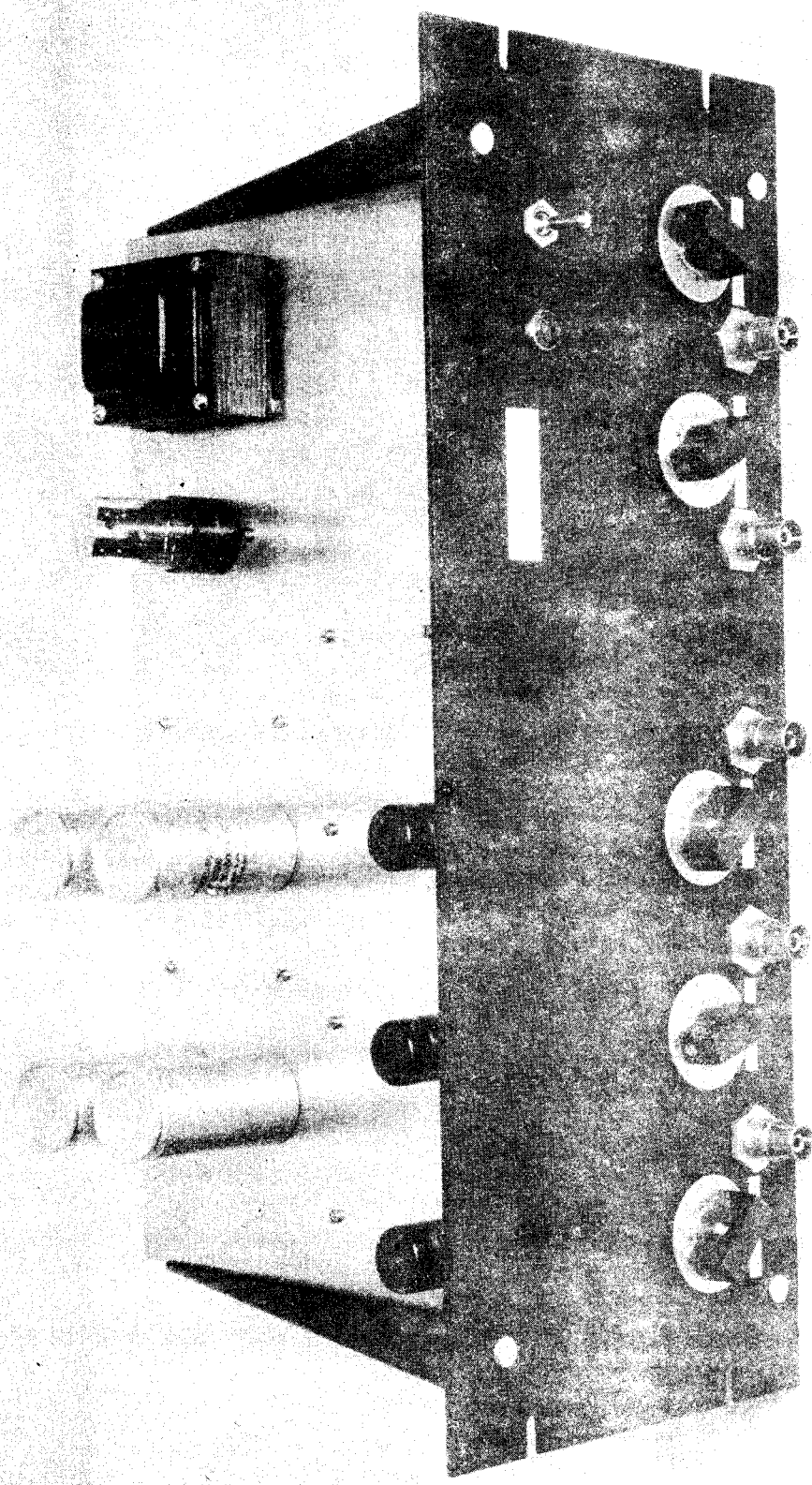

FIG. 47. HARMONIC SERIES GENERATOR (TOP-FRONT VIEW)

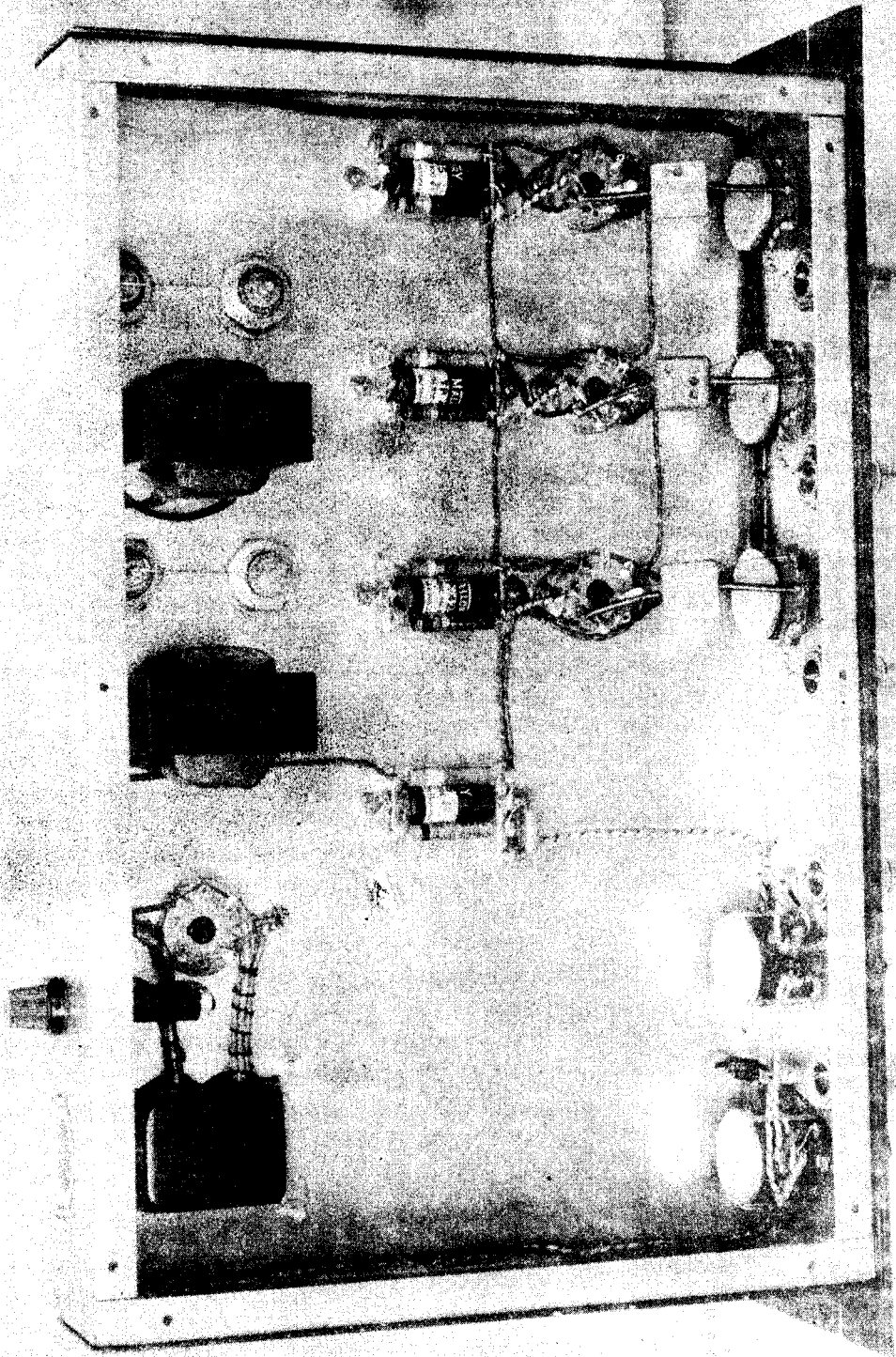

FIG. 48. HARMONIC SERIES GENERATOR (BOTTOM VIEW)

ms

U. S. DEPARTMENT OF COMMERCE
NATIONAL BUREAU OF STANDARDS
CENTRAL RADIO PROPAGATION LABORATORY
WASHINGTON, D. C.

