

NATIONAL BUREAU OF STANDARDS REPORT

NBS PROJECT

8440-12-84105

NBS REPORT

6709

July 18, 1960

THE POWER SPECTRUM AND ITS IMPORTANCE IN PRECISE FREQUENCY MEASUREMENTS

by

J. A. Barnes and R. C. Mockler

Presented before the 1960 Conference
on Standards and Electronic Measurements

To be published in
IRE Transactions on Instrumentation,
October, 1960



U. S. DEPARTMENT OF COMMERCE
NATIONAL BUREAU OF STANDARDS
BOULDER LABORATORIES
Boulder, Colorado

IMPORTANT NOTICE

NATIONAL BUREAU OF STANDARDS REPORTS are usually preliminary or progress accounting documents intended for use within the Government. Before material in the reports is formally published it is subjected to additional evaluation and review. For this reason, the publication, reprinting, reproduction, or open-literature listing of this Report, either in whole or in part, is not authorized unless permission is obtained in writing from the Office of the Director, National Bureau of Standards, Washington 25, D. C. Such permission is not needed, however, by the Government agency for which the Report has been specifically prepared if that agency wishes to reproduce additional copies for its own use.

THE POWER SPECTRUM AND ITS IMPORTANCE IN
PRECISE FREQUENCY MEASUREMENTS

J. A. Barnes and R. C. Mockler
National Bureau of Standards
Boulder, Colorado

TABLE OF CONTENTS

	Page
LIST OF FIGURES	ii
ABSTRACT	1
1. INTRODUCTION	2
2. THE POWER SPECTRUM	3
3. SOME METHODS OF POWER SPECTRAL ANALYSIS	5
4. INSTANTANEOUS FREQUENCY AND ITS RELATION TO THE FOURIER FREQUENCY COMPONENTS	9
5. CONCLUSION	17
6. REFERENCES	28
APPENDIX	29

LIST OF FIGURES

	Page
Fig. 1 Ammonia Maser - Spectrum analyzer system	20
Fig. 2 Figure 2(a) shows the square root of the power spectrum for a 3.3 Mc signal. Figures 2(b) and 2(c) show the same signal after being multiplied in frequency by factors of 3 and 9 respectively	21
Fig. 3 Trace 1 is a high resolution spectrum of the central peak of a 10 Mc quartz crystal oscillator whose crystal was thermostated in a liquid helium cryostat ^[5] . The oscillator was equipped with dc filaments but still exhibited 60 cps sidebands about 30 db below the central peak (not shown in this figure). This oscillator operates at about 13.4 cps above 10 Mc and apparently some pickup of the standard is responsible for the sidebands shown in this trace. Trace 2 is the response curve of the spectrum analyser.	22
Fig. 4 This spectrum was obtained from the same oscillator as Figure 3. At the time this trace was made, however, the oscillator was equipped with 60 cps, ac filaments. (Note the different frequency scale).	23
Fig. 5 This spectrum was obtained by analysing the direct beat note between the <u>free running</u> oscillator-multiplier-chain-system and the ammonia maser. It is this oscillator which is phase locked to the maser to give a relatively pure signal to be used in the analysing of other oscillators. The response curve of the analyser was obtained by replacing the maser-oscillator beat note by the signal from a high quality signal generator.	24

LIST OF FIGURES

(cont.)

- | | Page |
|---|------|
| Fig. 6 This spectrum was obtained by intentionally frequency modulating the oscillator of Fig. 5 at a 50 cps rate. The total swing in frequency of the oscillator was about 2 parts in 10^{10} peak to peak, (note the small sidebands at 50 cps on either side of the central peak). | 25 |
| Fig. 7 This is a spectrum of a 100 kc oscillator, again multiplied 145,800 in frequency, located two floors above the room containing the maser-spectrum-analyser system. The signal apparently picked up noise in the long cables connecting the two rooms. The upper trace was taken approximately one hour after the multiplier chain in the spectrum analyser was first turned on, and the lower trace about 6 hours after the chain was turned on, showing the effect of warm up time of a multiplier chain on a noisy signal. (Note the scale). | 26 |
| Fig. 8 Recording of direct beat note between free running oscillator and maser. A numerical analysis of these recordings could also be run to determine the power spectrum. | 27 |

THE POWER SPECTRUM AND ITS IMPORTANCE IN
PRECISE FREQUENCY MEASUREMENTS

J. A. Barnes and R. C. Mockler
National Bureau of Standards
Boulder, Colorado

ABSTRACT

The power spectral density functions of a frequency multiplier chain, driven by several different crystal oscillators, were obtained by comparing the output with a second chain which was stabilized with an ammonia maser. The frequency of the maser stabilized chain was demonstrated to be relatively fixed; the power spectrum of the other chain was determined by two different methods. The results are compared. Possible errors and uncertainties introduced by the methods are discussed. An analysis is made that relates the instantaneous frequency fluctuations of a signal with the power spectral density function.

Analysis predicts that when frequency modulation occurs in the first stages of frequency multiplication or in the primary frequency oscillator, the output power spectrum is, in general, not symmetrical. Furthermore, the sidebands are increased in intensity by the multiplication process. This is, in fact, observed to be the case. It is shown that a frequency counter will measure the frequency of the center of gravity of the power spectrum.

If signals having a complex power spectrum are used in precise frequency measurements, errors may result.

1. INTRODUCTION

The behavior of stable signal sources such as crystal oscillators, frequency multiplier chains and masers can be usefully described in terms of their power spectra.

The problem of precise frequency measurement can be understood only by a fairly detailed knowledge of the frequency source and the effect of the measuring system. It is usually sufficient for this "detailed knowledge" to be given in terms of the power spectrum.

In general there are two methods of precise frequency measurement: (1) determining the total elapsed phase in an interval of time with an apparatus like a synchronous clock or a frequency counter, and (2) direct frequency measurement by a resonance method usually involving a molecular or atomic transition.

It can be shown that, in general, a frequency counter will, on the average, measure the frequency of the center of gravity of a power spectrum resulting from frequency modulation of the signal. An atomic or molecular resonance, however, will not, in general, measure the center of gravity of the power spectrum. Thus for a meaningful comparison between an atomic resonance and the output of a frequency multiplier chain it is essential to know the spectral distribution of the signal from the chain and the spectral distribution of the atomic resonance (including atomic transitions nearby the particular transition of interest).

In practice, of course, one attempts to obtain a monochromatic source of radiation for the measurements. The results of power spectral analysis with the ammonia maser spectrum analyzer^[1] are very helpful in this regard. Redesign and modifications can be made until the observed power spectrum has the proper character and purity.

It is the purpose of this report to discuss certain methods of obtaining the power spectrum and sample results of such experiments. The mean instantaneous frequency and the variance of the instantaneous frequency are related to the power spectrum. These relations are particularly useful in the description of the short time frequency stability of signal generators particularly in view of the simplicity with which the power spectra can be obtained.

2. THE POWER SPECTRUM^[2]

Suppose that the output voltage of a signal generator is some function of the time, $V(t)$. We can write

$$V(t) = \frac{1}{2\pi} \int_{-\infty}^{\infty} a(\omega)e^{i\omega t} d\omega \quad (1)$$

provided that $a(\omega)$ vanishes at plus and minus infinity. From the Fourier integral theorem

$$a(\omega) = \int_{-\infty}^{\infty} V(t)e^{-i\omega t} dt \quad (2)$$

In Eq. (2) it is supposed that $V(t) = 0$ outside some finite time interval $t = -\frac{T}{2}$ to $t = \frac{T}{2}$ for the purpose of avoiding convergence difficulties.

Then

$$a(\omega) = \int_{-\frac{T}{2}}^{\frac{T}{2}} V(t)e^{-i\omega t} dt \quad (3)$$

Physically $a(\omega)d\omega$ may be considered the amplitude of the frequency component of $V(t)$ lying in the range ω to $\omega + d\omega$.

The total energy dissipated in a unit resistor in the time interval $-\frac{T}{2} \leq t \leq \frac{T}{2}$ is given by

$$\int_{-\frac{T}{2}}^{\frac{T}{2}} |V(t)|^2 dt = \frac{1}{2\pi} \int_{-\frac{T}{2}}^{\frac{T}{2}} V(t) \int_{-\infty}^{\infty} a^*(\omega) e^{-i\omega t} d\omega dt$$

$$= \frac{1}{2\pi} \int_{-\infty}^{\infty} a^*(\omega) d\omega \int_{-\frac{T}{2}}^{\frac{T}{2}} V(t) e^{-i\omega t} dt$$

$$= \int_{-\infty}^{\infty} \frac{a^*(\omega) a(\omega)}{2\pi} d\omega$$

$$\int_{-\frac{T}{2}}^{\frac{T}{2}} |V(t)|^2 dt = \int_{-\infty}^{\infty} \frac{|a(\omega)|^2}{2\pi} d\omega \quad (4)$$

The average power dissipated in this time interval T is given by

$$\bar{P}_T = \frac{1}{T} \int_{-\frac{T}{2}}^{\frac{T}{2}} |V(t)|^2 dt = \int_{-\infty}^{\infty} \frac{|a(\omega)|^2}{2\pi T} d\omega \quad (5)$$

$$\overline{P}_T = \int_{-\infty}^{\infty} P_T(\omega) d\omega \quad (6)$$

where

$$P_T(\omega) = \frac{|a(\omega)|^2}{2\pi T} .$$

$P_T(\omega)$ is the average power dissipated per unit frequency interval at the angular frequency ω and for the particular time interval T . The power spectrum or the power spectral density is sometimes defined as

$$P(\omega) = \lim_{T \rightarrow \infty} \frac{|a(\omega)|^2}{2\pi T} . \quad (7)$$

This is a proper definition provided that the limit exists. These convergence difficulties can often be avoided by taking the ensemble average. Thus for an ensemble of time functions $V_i(t)$, each member of the ensemble having a time duration T , there corresponds an ensemble $[P_T(\omega)]_i$. The power spectral density can then be defined as

$$P(\omega) = \lim_{T \rightarrow \infty} \langle [P_T(\omega)]_i \rangle = \lim_{T \rightarrow \infty} \left\langle \frac{|a_i(\omega)|^2}{2\pi T} \right\rangle \quad (8)$$

where the brackets denote the ensemble average.

3. SOME METHODS OF POWER SPECTRAL ANALYSIS

The experimental determination of the power spectral density of rather narrow banded signal generators is the concern of this report. Various methods are possible. The technique that we have found most convenient is described in some detail (see reference 1).

A heterodyne method is used to sweep the power spectrum over a fixed narrow band filter. In most cases the bandwidth of the filter, $\Delta\omega$, is much narrower than the total width of the power spectrum. The square root of the power spectrum is plotted directly on an x-y plotter in a time short compared to systematic variations but long enough to be consistent with the analyser's bandwidth.

The power in the frequency bandwidth of the filter -- $(\omega - \frac{\Delta\omega}{2})$ to $(\omega + \frac{\Delta\omega}{2})$ -- at frequency ω is given approximately by

$$P_T(\omega, \Delta\omega) \approx \int_{\omega - \frac{\Delta\omega}{2}}^{\omega + \frac{\Delta\omega}{2}} P_T(\omega) d\omega \quad (9)$$

where T is the observation time. If T is made indefinitely long, $P_T(\omega, \Delta\omega)$ will tend toward a limit.

$$P(\omega, \Delta\omega) = \lim_{T \rightarrow \infty} P_T(\omega, \Delta\omega) \quad (10)$$

The limit of the ratio $\frac{P(\omega, \Delta\omega)}{\Delta\omega}$ as $\Delta\omega \rightarrow 0$ provides a definition of the true power spectral density; i. e.,

$$P(\omega) = \lim_{\Delta\omega \rightarrow 0} \frac{P(\omega, \Delta\omega)}{\Delta\omega} \quad (11)$$

or

$$P(\omega) = \lim_{\substack{\Delta\omega \rightarrow 0 \\ T \rightarrow \infty}} \frac{P_T(\omega, \Delta\omega)}{\Delta\omega} \quad (12)$$

This defines the power spectrum in terms more directly related to the experiment than does Eq. (8)^[3].

The averaging time interval or record length T used in the experiment is not infinitely long, but it is sufficiently long such that any increase in T does not change the character of the plotted spectrum perceptibly, (i. e., the reciprocal of the record length, $\frac{1}{T}$, is much less than the bandwidth of the filter). The record length in this type of experiment is the time taken to sweep over a frequency interval equal to the width of the filter bandpass.

In the practical situation, the signal analyzed will have been modified by the transmission characteristics of the detector, filter, amplifier and smoothing circuits. The effects due to the instrumentation must be taken into account and some modification must be made on the previous discussion.

Let us assume that the filter is tuned to some frequency ω_0 and that the transfer function of the filter is given by $G(\omega_0, \omega)$. Also, if the input voltage to the filter, $V(t)$, has its Fourier transform, $a(\omega)$, given by

$$a(\omega) = \int_{-\infty}^{\infty} V(t)e^{-i\omega t} dt \quad , \quad (13)$$

then the output voltage of the filter is given by

$$V_o(\omega_0, t) = \frac{1}{2\pi} \int_{-\infty}^{\infty} G(\omega_0, \omega)a(\omega)e^{i\omega t} d\omega \quad . \quad (14)$$

The average power delivered to a load by the filter is then proportional to

$$P_o(\omega_0) = \lim_{T \rightarrow \infty} \frac{1}{T} \int_{-\frac{T}{2}}^{\frac{T}{2}} V_o^2(\omega_0, t) dt. \quad (15)$$

Comparison of Eqs. (14) and (15) with Eqs. (1), (2), and (7) gives

$$P_o(\omega_o) = \int_{-\infty}^{\infty} |G(\omega_o, \omega)|^2 P(\omega) d\omega, \quad (16)$$

where $P(\omega)$ is the actual power spectrum of $V(t)$.

$P_o(\omega_o)$ is our estimate of the power density at the angular frequency ω_o . It is an estimate of the local power density, $P(\omega)$, only to the degree to which $|G(\omega_o, \omega)|^2$ approximates a Dirac delta function.

Sample spectra are displayed in Figures 2, 3, and 4. The discrete line spectrum of Figure 4 results from the introduction of frequency modulation by two (or more) signals, 60 cps and 120 cps (the oscillator used 60 cps ac filaments). In this particular spectrum the bandwidth of the filter is larger than the total width of any one of the lines of the spectrum^[4]. The spectrum was produced by a crystal oscillator in which the crystal was emersed in liquid helium driving a frequency multiplier chain. The power spectrum of Figure 4 may be written approximately as

$$P(\omega) \approx \sum_{i=1}^N q_i \delta(\omega - \omega_i) \quad (17)$$

in view of the low resolution relative to the width of a single peak. In Eq. (17), q_i is a weighting factor for a particular peak at angular frequency ω_i . $\delta(\omega - \omega_i)$ is the Dirac delta function. In order to see the structure of the individual peaks additional frequency multiplication would be required or a substantial decrease in the filter bandwidth.

The power spectrum can also be estimated by a numerical analysis from a recorded plot of $V(t)$. An example of such a plot is shown in Figure 8. The various methods of analysis of such recordings are to be found in the literature^[6].

4. INSTANTANEOUS FREQUENCY AND ITS RELATION TO THE FOURIER FREQUENCY COMPONENTS

In general, there are two methods of precise frequency measurement: (1) determining the total elapsed phase in an interval of time with an apparatus like a synchronous clock or a frequency counter, and (2) direct frequency measurement by a resonance method usually involving a molecular or atomic transition.

The elapsed phase method of frequency measurement has two modifications: (1) a frequency counter which counts the number of cycles in a unit of time, and (2) period measurement which measures the time interval between two positive going crossovers of the signal. Either system gives the "average" frequency in a time interval δT such that

$$\bar{\Omega} = \frac{\delta\phi}{\delta T} = \frac{1}{\delta T} \int_T^{T+\delta T} \dot{\phi} dt \quad (18)$$

where $\delta\phi$ is the elapsed phase in the time interval δT . In the case of the period measuring scheme, $\delta\phi = 2\pi$ and the δT corresponding to this phase change is what is measured.

It is important to realize at this point that these measurements are not simply related to the Fourier components of the signal being measured, at least a priori. This is evident since, given a pure sine wave which lasts from T to $T + \delta T$, the Fourier components are spread over a frequency range $\delta\omega \approx \frac{1}{\delta T}$, and thus a resonance method of frequency measurement would have an uncertainty in the measured frequency of the order of $\delta\omega$. For a period measuring scheme, however, the average instantaneous frequency of the sine wave is possibly measured to an accuracy for exceeding $\delta\omega = \frac{1}{\delta T}$.

A simple example should serve to illustrate this point: Consider a very stable oscillator which generates a signal of approximately 100 cps. If this signal is used to gate a counter which is arranged to count a very stable and accurate 1 Mc signal, the counter will count for about $\frac{1}{100}$ sec. and the counter will display the period accurate to about $\pm 1 \mu$ sec; that is, to an accuracy of about $\pm 10^{-2}$ cps! Thus with this scheme we have measured the average instantaneous frequency (not a Fourier frequency component) in a period of 10^{-2} seconds with a possible error of $\pm 10^{-2}$ cps instead of the ± 50 cps error of measuring the Fourier components. (Similar examples can be worked out for a frequency multiplier-frequency-counter system instead of the period measuring system).

Returning to Eq. (18), let us suppose that the time of measurement, δT , is made small enough that $\dot{\phi}(t)$ makes no appreciable change in this interval of time. With these conditions satisfied, we see that the measurement gives the instantaneous frequency,

$$\Omega(t) \equiv \dot{\phi}(t) \approx \frac{\delta\phi}{\delta T} .$$

It is possible to obtain some relations between the instantaneous frequency of a signal and its Fourier components for the case of a signal without amplitude modulation. Such a signal is of the form

$$E(t) = \frac{E_0}{2} \left(e^{i\phi(t)} + e^{-i\phi(t)} \right) \quad (19)$$

where E_0 is a constant and $\phi(t)$ is some real function of the time. For the following discussion we will consider only the function

$$f(t) = e^{i\phi(t)} \quad (20)$$

The second term on the right of Eq. (19) only serves to symmetrize the power spectrum (since $E(t)$ is real but $f(t)$ is not). Thus anything which can be said of the frequency of $f(t)$ can easily be extended to $E(t)$.

The importance of considering only $f(t)$ is that it satisfies the equations

$$\left. \begin{aligned} f^*f &= 1 \\ -if^*\frac{df}{dt} &= \dot{\phi} \end{aligned} \right\} \quad (21)$$

Thus an instantaneous frequency for $f(t)$ can be defined as

$$\Omega(t) \equiv \dot{\phi}(t) = -if^*\frac{df}{dt} \quad (22)$$

In order to obtain some connections with the power spectrum of $f(t)$, consider the function $f_T(t)$ defined by the relations

$$f_T(t) = \begin{cases} f(t) & \text{for } -\frac{T}{2} \leq t \leq \frac{T}{2} \\ 0 & \text{otherwise} \end{cases} \quad (23)$$

Thus $f_T(t)$ can be represented as a Fourier series in the interval $-\frac{T}{2} \leq t \leq \frac{T}{2}$

$$f_T(t) = \sum_{n=-\infty}^{\infty} e^{i \frac{2\pi n t}{T}} C_n \quad (24)$$

where

$$C_n = \frac{1}{T} \int_{-\frac{T}{2}}^{\frac{T}{2}} e^{-i \frac{2\pi n t}{T}} f(t) dt. \quad (25)$$

This is a valid representation for $f_T(t)$ only in the interval $-\frac{T}{2} \leq t \leq \frac{T}{2}$, since the Fourier series in (16) is that of a periodic wave of period T beyond this interval. Thus by this rather conventional means^[6] we will compute the spectral distribution of $f_T(t)$ and then pass to the limit $T \rightarrow \infty$ where

$$f(t) = \lim_{T \rightarrow \infty} f_T(t).$$

First, define

$$TC_n = a_T \left(\frac{2\pi n}{T} \right)$$

where the paranthesis mean a_T is a function of $\left(\frac{2\pi n}{T} \right)$, so Eqs. (24) and (25) become

$$f_T(t) = \sum_{n=-\infty}^{\infty} a_T \left(\frac{2\pi n t}{T} \right) e^{i \frac{2\pi n t}{T}} \left(\frac{1}{T} \right), \quad (24')$$

$$a_T\left(\frac{2\pi n}{T}\right) = \int_{-\frac{T}{2}}^{\frac{T}{2}} f(t)e^{-i\frac{2\pi n t}{T}} dt \quad (25')$$

Substitution of Eq. (24') and its complex conjugate into (22) gives

$$\Omega_T(t) = \sum_{m, n=-\infty}^{\infty} \left(\frac{2\pi n}{T}\right) e^{i\frac{2\pi(n-m)t}{T}} a_T\left(\frac{2\pi n}{T}\right) \left(\frac{1}{T}\right)^2 a_T^*\left(\frac{2\pi m}{T}\right) \quad (26)$$

Taking the time average of Eq. (26) over the interval $-\frac{T}{2} \leq t \leq \frac{T}{2}$ yields

$$\bar{\Omega}_T = \frac{1}{2\pi} \sum_{n=-\infty}^{\infty} \left(\frac{2\pi n}{T}\right) \frac{|a_T\left(\frac{2\pi n}{T}\right)|^2}{T} \left(\frac{2\pi}{T}\right) \quad (27)$$

since

$$\frac{1}{T} \int_{-\frac{T}{2}}^{\frac{T}{2}} e^{i\frac{2\pi(n-m)t}{T}} dt = \begin{cases} 1 & \text{if } n = m \\ 0 & \text{if } n \neq m \end{cases}$$

If we now pass to the limit as T becomes very large, $\frac{2\pi n}{T}$ approaches a continuous variable, say ω , since each unit change in n changes $\frac{2\pi n}{T}$ by only $\frac{2\pi}{T}$, a very small quantity. Also the first differ-

ence of $\frac{2\pi n}{T}$ is $\frac{2\pi}{T}$ which approaches $d\omega$ as T becomes very large. Thus Eq. (27) becomes in the limit

$$\Omega = \int_{-\infty}^{\infty} P(\omega)\omega d\omega \quad (28)$$

where

$$P(\omega) = \lim_{T \rightarrow \infty} \frac{|a_T(\omega)|^2}{2\pi T} \quad (7)$$

is the power spectrum of $f(t)$.

The right side of Eq. (28) is just the average frequency, $\langle \omega \rangle$, of the Fourier components since from Eq. (4)

$$\int_{-\infty}^{\infty} P(\omega) d\omega = 1 \quad (29)$$

for $f(t)$ satisfying (21). Equivalently, the right side of (28) is the center of gravity of $P(\omega)$. Thus Eq. (28) shows that the time average of the instantaneous frequency is just the center of gravity of the power spectrum for a frequency modulated signal. Returning to Eq. (18) we see that the elapsed phase method of frequency measurement gives the time average of the instantaneous frequency over the interval of measurement and thus if this interval is sufficiently long it will give the frequency of the center of gravity of the power spectrum!

It is also of interest to compute the variance (or mean square deviation from the mean) of the instantaneous frequency; that is, the quantity,

$$\begin{aligned} \overline{(\Omega(t) - \bar{\Omega})^2} &= \overline{\Omega^2} - 2\bar{\Omega} \overline{\Omega(t)} + \bar{\Omega}^2 \\ &= \overline{\Omega^2} - \bar{\Omega}^2 . \end{aligned} \tag{30}$$

Since $\Omega(t)$ is a real function,

$$\Omega(t) = \Omega^*(t) = i f \frac{df^*}{dt} ;$$

$$\therefore \Omega^2(t) = f^* f \frac{df^*}{dt} \frac{df}{dt} = f^* \dot{f} . \tag{31}$$

Applying the procedure used above to Eq. (31) we obtain

$$\overline{\Omega^2} = \int_{-\infty}^{\infty} P(\omega) \omega^2 d\omega . \tag{32}$$

Combining Eqs. (28), (30) and (32) we obtain

$$\overline{(\Omega(t) - \bar{\Omega})^2} = \int_{-\infty}^{\infty} P(\omega) \omega^2 d\omega - \left[\int_{-\infty}^{\infty} P(\omega) \omega d\omega \right]^2 . \tag{33}$$

But

$$\int_{-\infty}^{\infty} P(\omega)(\omega - \langle \omega \rangle)^2 d\omega = \int_{-\infty}^{\infty} P(\omega)\omega^2 d\omega - \langle \omega \rangle^2 \quad (34)$$

where use has been made of Eq. (29) and

$$\langle \omega \rangle \equiv \int_{-\infty}^{\infty} P(\omega)\omega d\omega \quad .$$

Therefore combining Eqs. (33) and (34) gives

$$\overline{\Omega(t) - \bar{\Omega}}^2 = \int_{-\infty}^{\infty} P(\omega)(\omega - \langle \omega \rangle)^2 d\omega \quad . \quad (35)$$

That is, the variance of the instantaneous frequency is just the second moment of the power spectrum.

Returning now to Eq. (19), it is easily proveable that if the average Fourier frequency, ω , of $f(t)$ is very large compared to the width of the spectrum, the addition of the term $e^{-i\phi(t)}$ adds a term to the power spectrum of the form $P(-\omega)$, and thus it is possible to treat the so called "one sided" power spectrum of $E(t)$. Taking into account the multiplicative constant in Eq. (19), Eqs. (28) and (35) take the form

$$\bar{\Omega} = \frac{2}{E_0} \int_0^{\infty} P'(\omega)\omega d\omega \equiv \langle \omega \rangle \quad (28')$$

$$\overline{(\Omega - \bar{\Omega})^2} = \frac{2}{E_0} \int_0^{\infty} P'(\omega)(\omega - \langle \omega \rangle)^2 d\omega \quad (35')$$

where $P'(\omega)$ is the power spectrum of $E(t)$ and these equations are subject to the condition

$$\bar{\Omega} \gg \left[\overline{(\Omega(t) - \bar{\Omega})^2} \right]^{\frac{1}{2}}$$

which is easily satisfied by most oscillators.

As an example of an application of Eq. (35'), the second moment of the spectrum of Figure 4 turns out to be about 30,000 cps²/sec², or the RMS frequency deviation is about 174 cps, or more than one part in 10⁸! For a one second count, however, this oscillator has a spread of only about ± 2 parts in 10¹¹ from second to second and a drift of only a few parts in 10¹¹ per day. One concludes that this spectrum must be very stable.

5. CONCLUSION

Power spectra of highly stable signal sources can be observed with the ammonia maser spectrum analyser in a convenient and rapid way. The short term stability of these sources can be obtained from these observed spectra simply and without the usual laborious analysis of large amounts of data.

The device has use as an instrument for investigating noise properties of signal sources and the multiplication processes in frequency multiplier chains.

Frequency modulation introduced into a crystal oscillator or multiplier chain is enhanced by the frequency multiplication process. In fact the sidebands in the power spectrum are found to be increased in amplitude by the factor of frequency multiplication--see Appendix. This is demonstrated in Figure 2. It can be demonstrated that the power spectrum of a signal that is frequency modulated by two or more modulating signals of different frequency will in general be unsymmetrical^[7]. This is vividly displayed in the power spectrum of Figure 4.

Spectrum analysis has provided a particularly useful tool in designing crystal oscillators and frequency multipliers such that they yield signals of the highest purity. From a study of the power spectra one is led to the conclusion that one of the most important things in obtaining a pure signal is to keep the electronics simple, and use dc filaments in the oscillator and early stages of multiplication. The signal source that provides the Bureau atomic frequency standards with the purest signals is a system involving a "master and a slave" oscillator. A simple one or two tube crystal oscillator that is loosely phase locked to a more elaborate crystal oscillator (with good long term stability) drives the frequency multiplier chain.

A knowledge of the power spectrum is important not only in describing frequency stability and noise analysis but for other reasons also.

For example, in atomic beam frequency standards, the simple theory of the spectral line shape assumes the atomic transition to be excited by pure sinusoidal or cosinusoidal radiation. In actual fact, of course, the transition is induced by a certain distribution of frequencies. This distribution is determined by the frequency multiplier and crystal oscillator from which the exciting radiation is derived. The radiation in general is composed of the carrier frequency, noise and dis-

crete sidebands resulting from frequency modulation. The discrete sidebands are usually due to 60 cps--the power frequency--and multiples thereof. In the atomic clock experiments it is found possible to reduce the noise to a low enough level so that it is not the limiting factor in the precision of the frequency measurements. The discrete sidebands are more difficult to remove. These sidebands are multiplied in intensity by the factor of frequency multiplication. This factor is usually quite large (~ 2000) and consequently these sidebands can introduce rather large frequency errors. Errors of this sort are particularly significant if the power spectrum is unsymmetrical. (Shifts of a few parts in 10^9 have been observed by actual experiments). Of course, if the power spectrum is known, the proper spectral line shape can be calculated in order to find the proper correction to the measured frequency. It is more desirable--and much simpler--to eliminate these sidebands so that the simple line shape theory applies. A knowledge of the power spectrum is essential in order to assign a figure of accuracy to the atomic beam frequency standards.

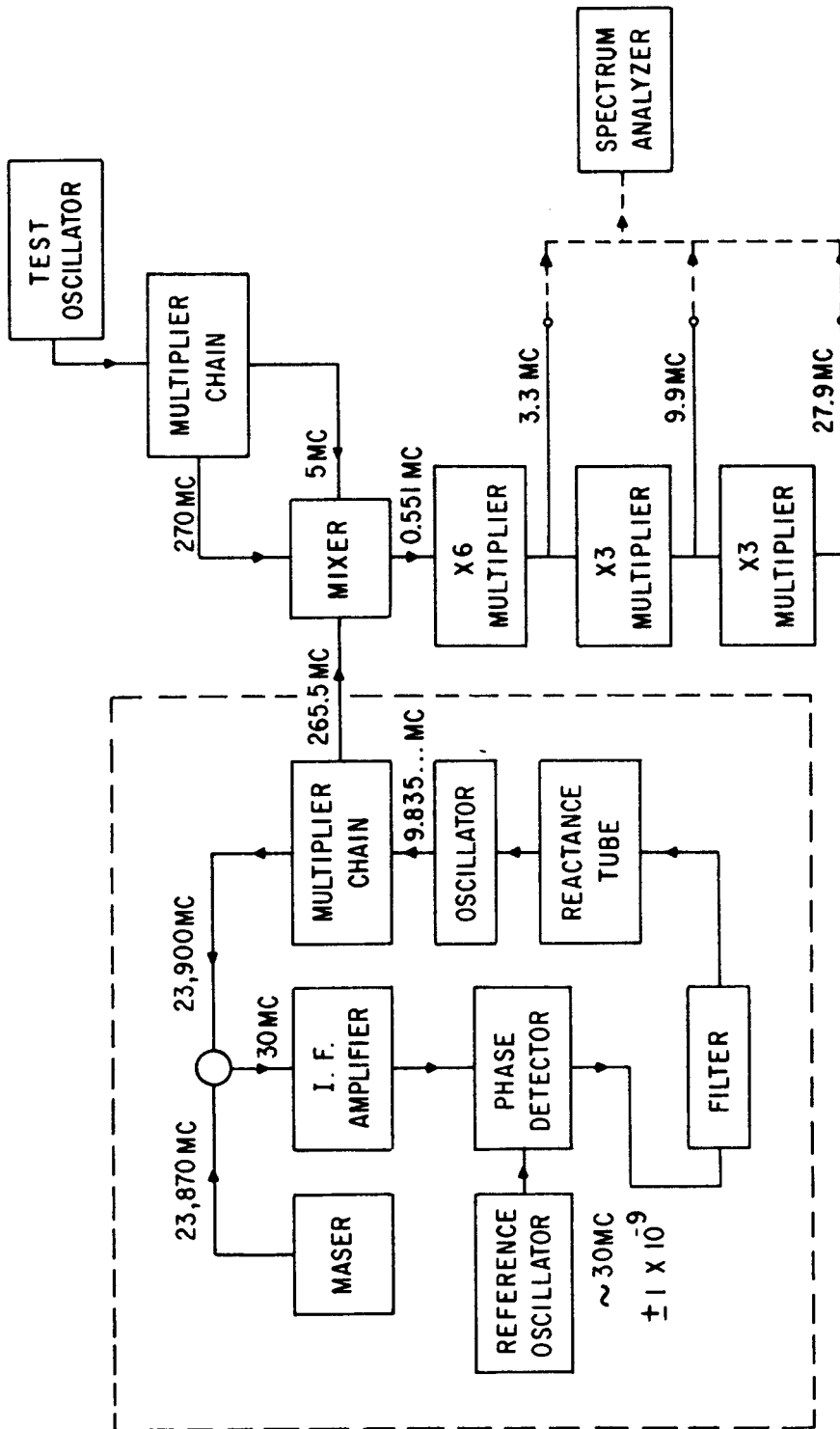

FIG. 1 AMMONIA MASER - SPECTRUM ANALYZER SYSTEM

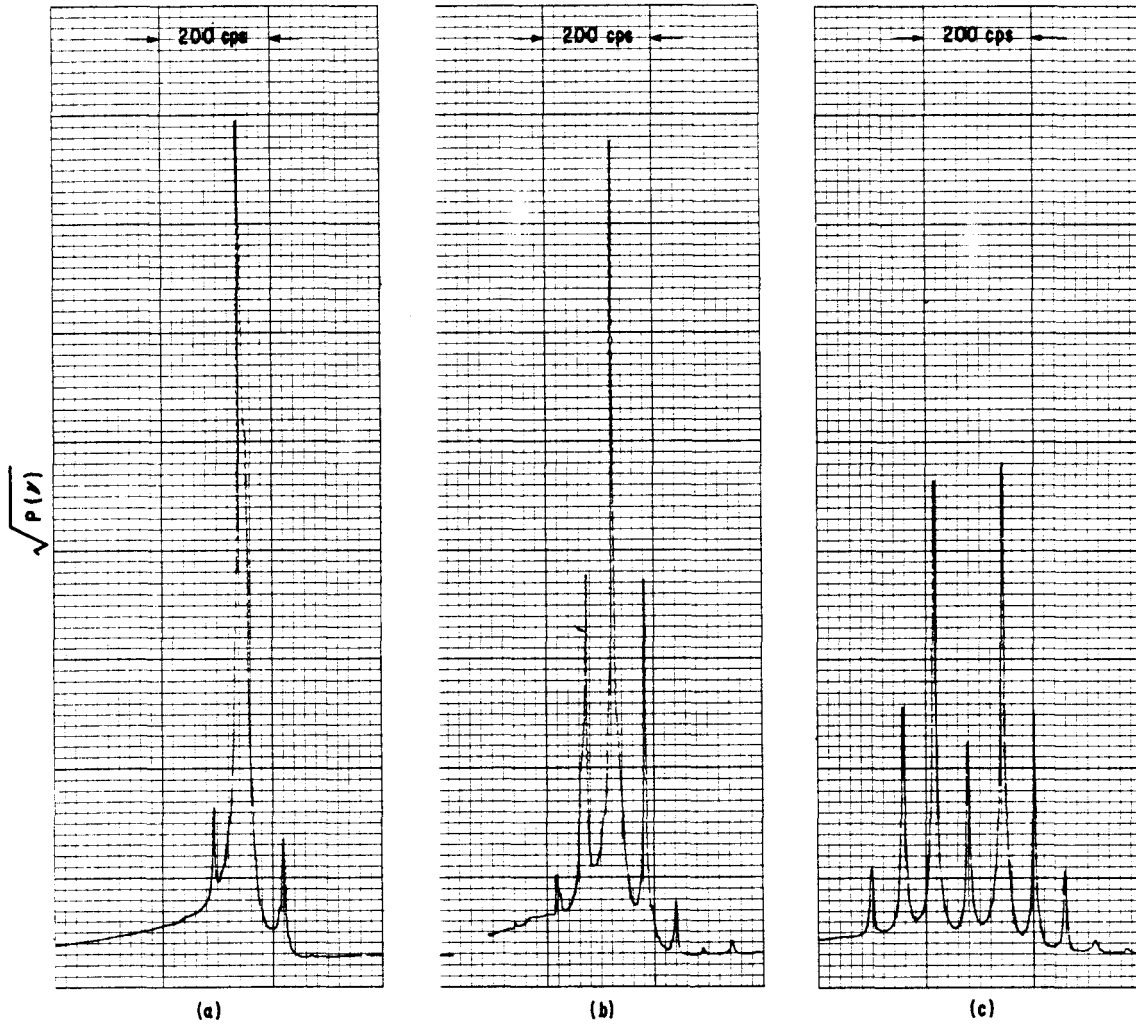

Fig. 2 Figure 2(a) shows the square root of the power spectrum for a 3.3 Mc signal. Figures 2(b) and 2(c) show the same signal after being multiplied in frequency by factors of 3 and 9 respectively.

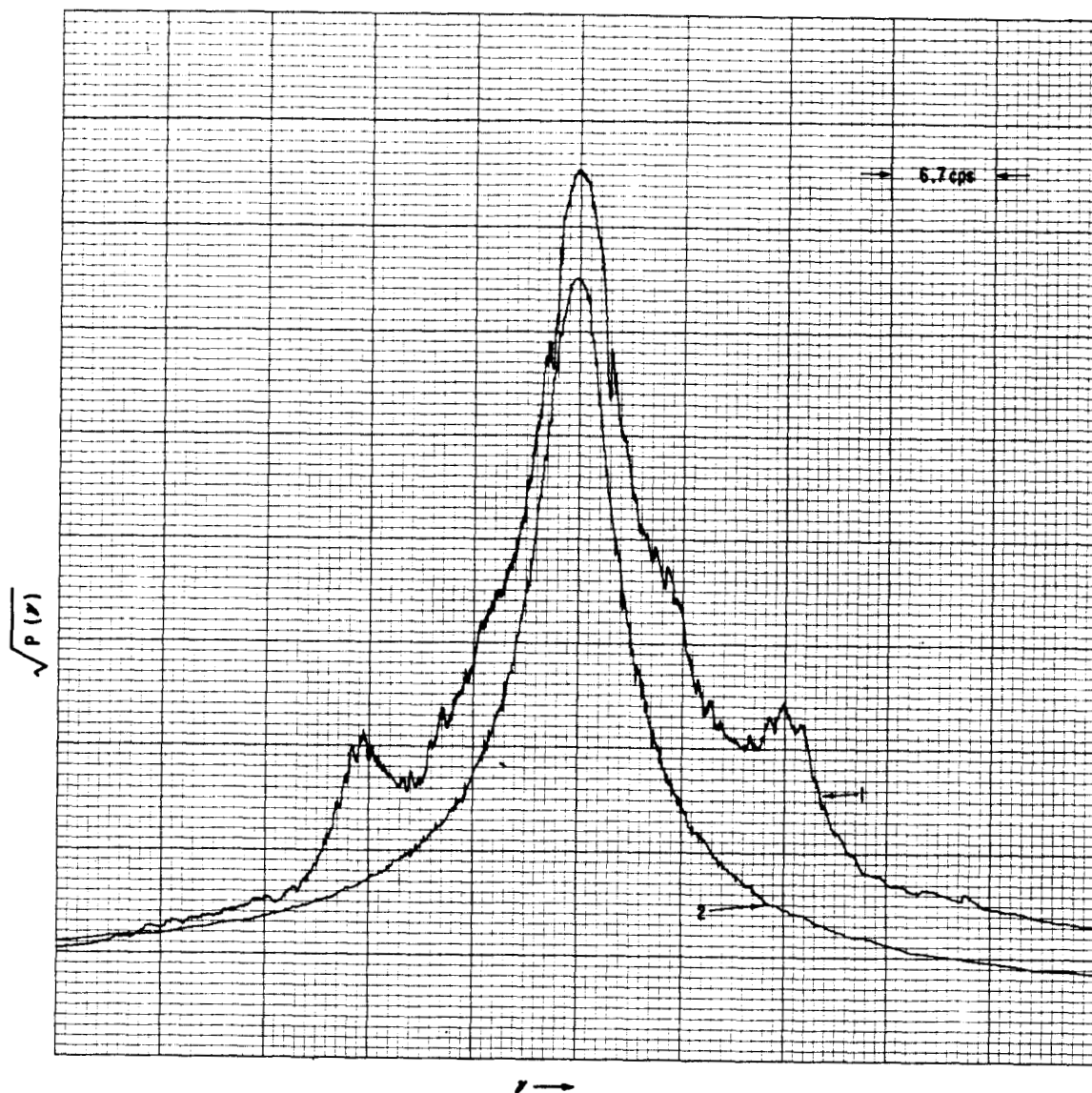

Fig. 3 Trace 1 is a high resolution spectrum of the central peak of a 10 Mc quartz crystal oscillator whose crystal was thermostated in a liquid helium cryostat^[5]. The oscillator was equipped with DC filaments but still exhibited 60 cps sidebands about 30 db below the central peak (not shown in this figure). This oscillator operates at about 13.4 cps above 10 Mc and apparently some pickup of the standard is responsible for the sidebands shown in this trace. Trace 2 is the response curve of the spectrum analyser.

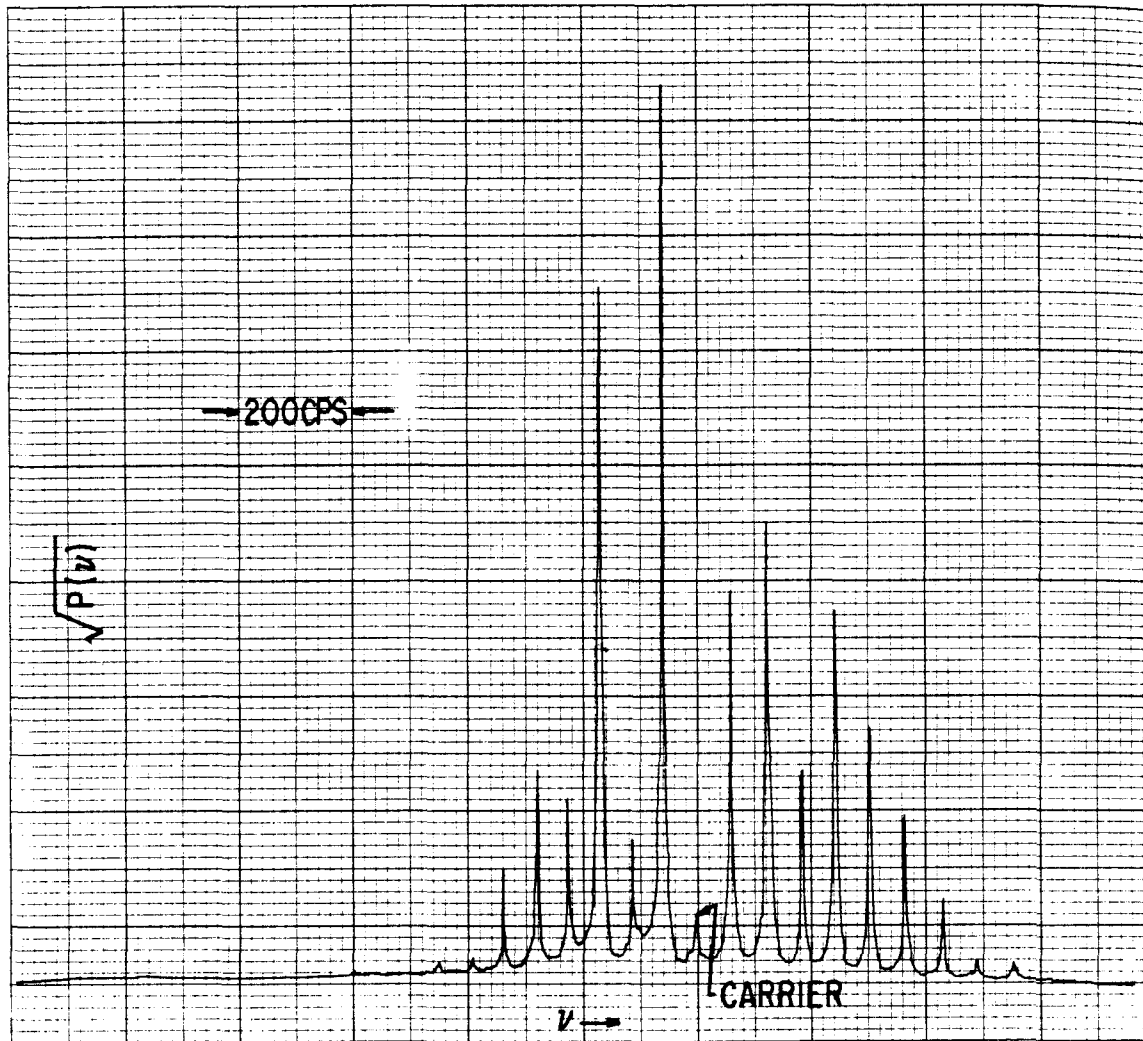

Fig. 4 This spectrum was obtained from the same oscillator as Figure 3. At the time this trace was made, however, the oscillator was equipped with 60 cps, ac filaments. (Note the different frequency scale).

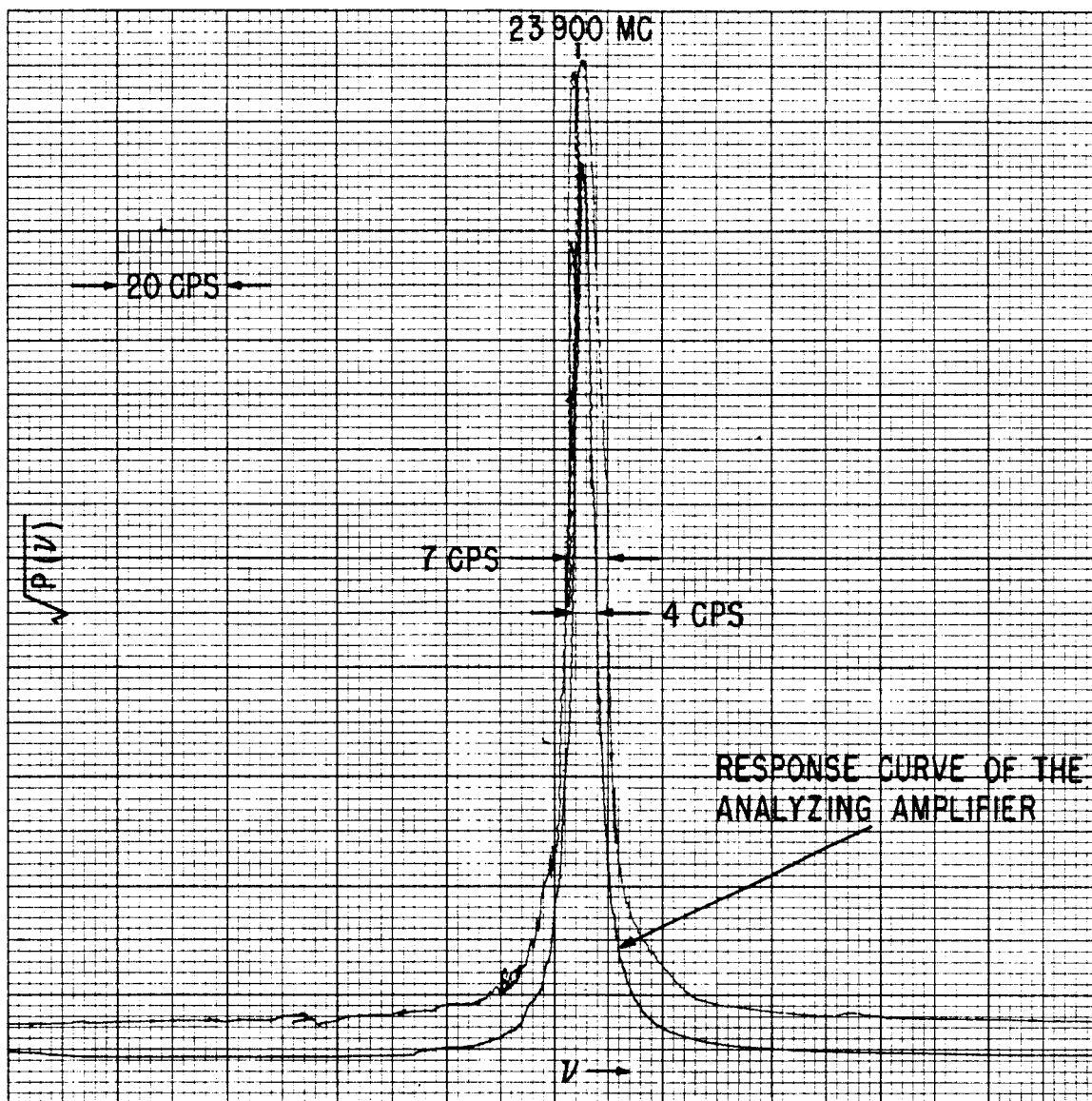

Fig. 5 This spectrum was obtained by analysing the direct beat note between the free running oscillator-multiplier-chain-system and the ammonia maser. It is this oscillator which is phase locked to the maser to give a relatively pure signal to be used in the analysing of other oscillators. The response curve of the analyser was obtained by replacing the maser-oscillator beat note by the signal from a high quality signal generator.

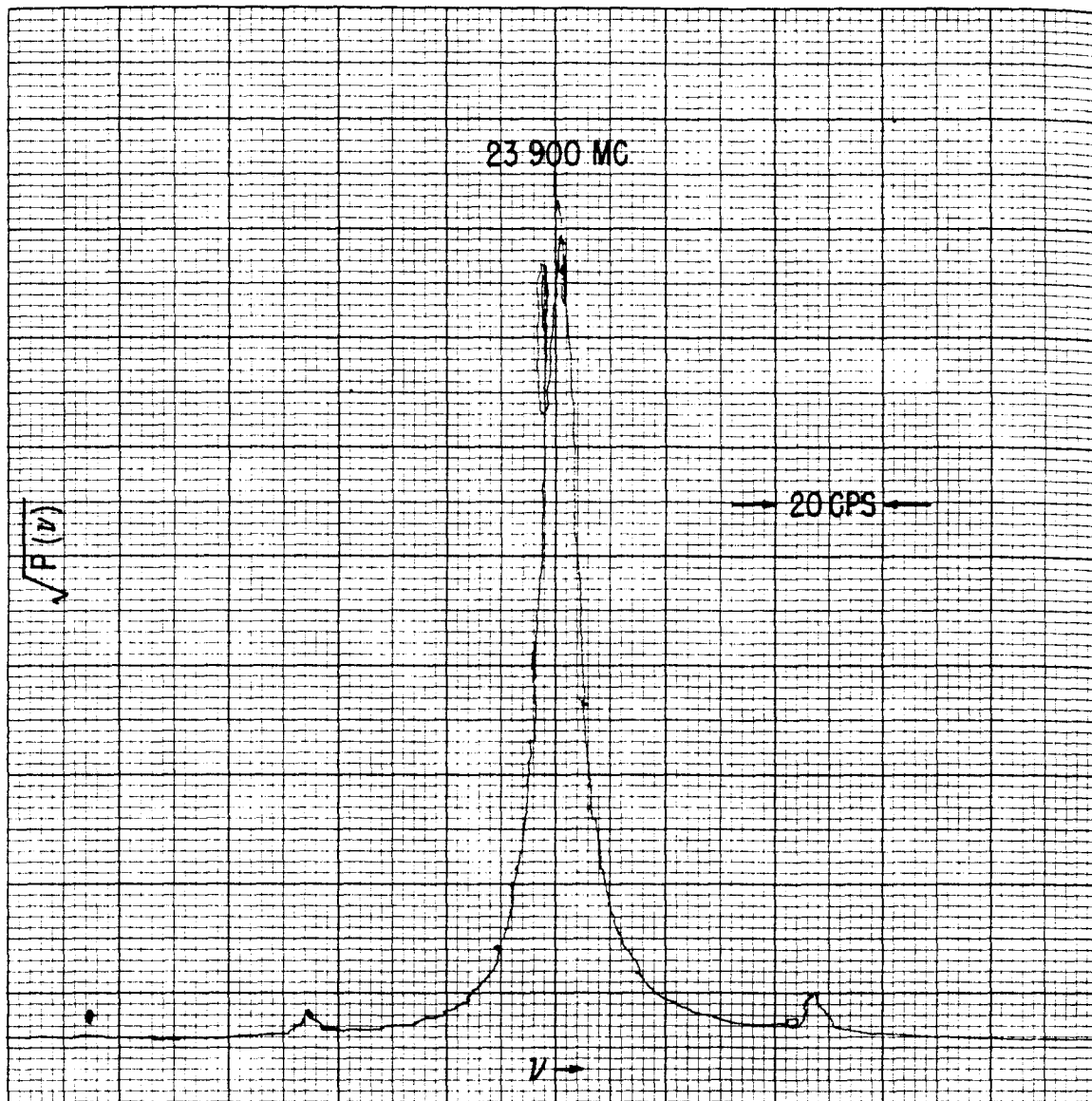

Fig. 6 This spectrum was obtained by intentionally frequency modulating the oscillator of Fig. 5 at a 50 cps rate. The total swing in frequency of the oscillator was about 2 parts in 10^{10} peak to peak, (note the small sidebands at 50 cps on either side of the central peak).

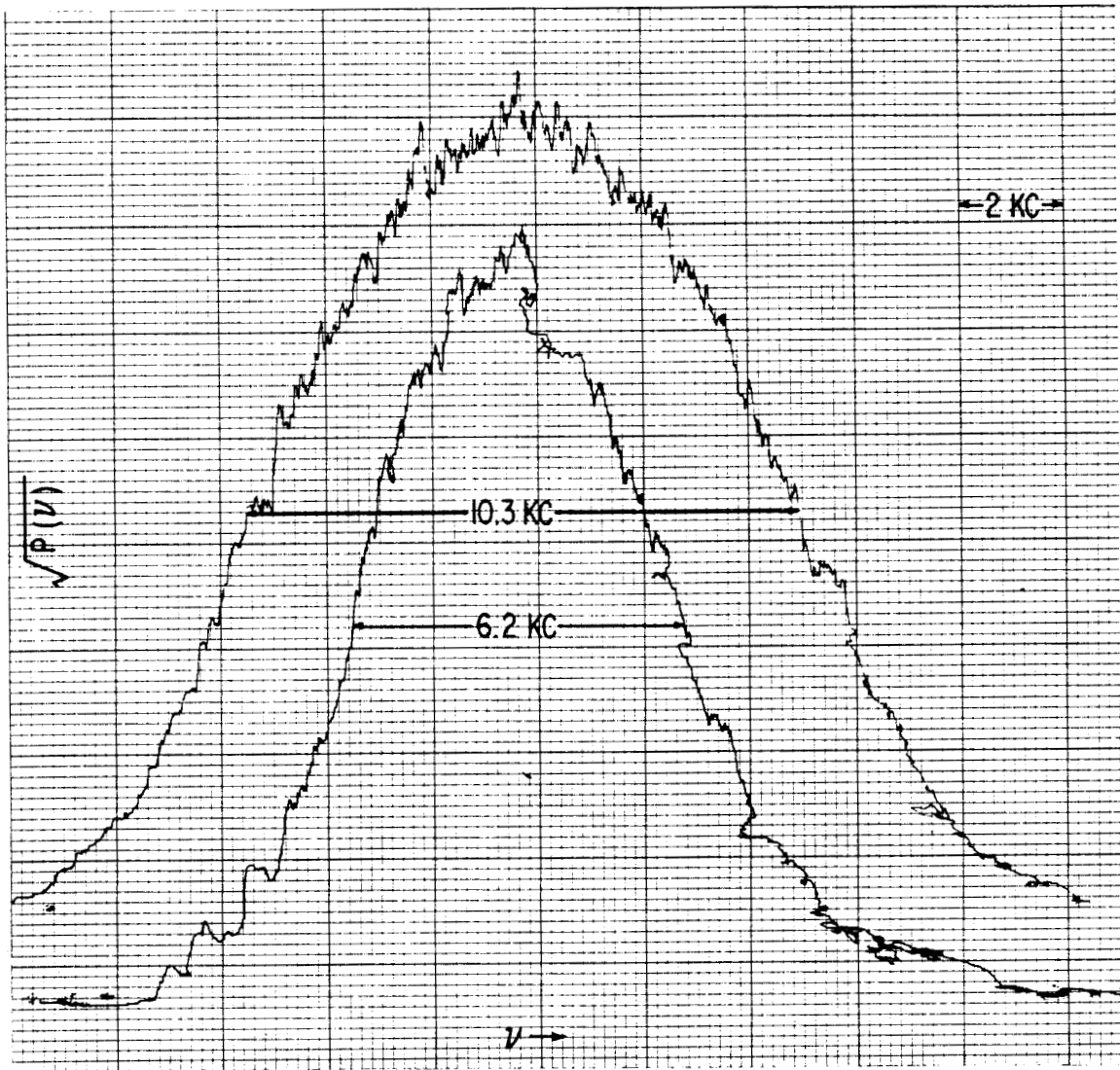

Fig. 7 This is a spectrum of a 100 kc oscillator, again multiplied 145,800 in frequency, located two floors above the room containing the maser-spectrum-analyser system. The signal apparently picked up noise in the long cables connecting the two rooms. The upper trace was taken approximately one hour after the multiplier chain in the spectrum analyser was first turned on, and the lower trace about 6 hours after the chain was turned on, showing the effect of warm up time of a multiplier chain on a noisy signal. (Note the scale).

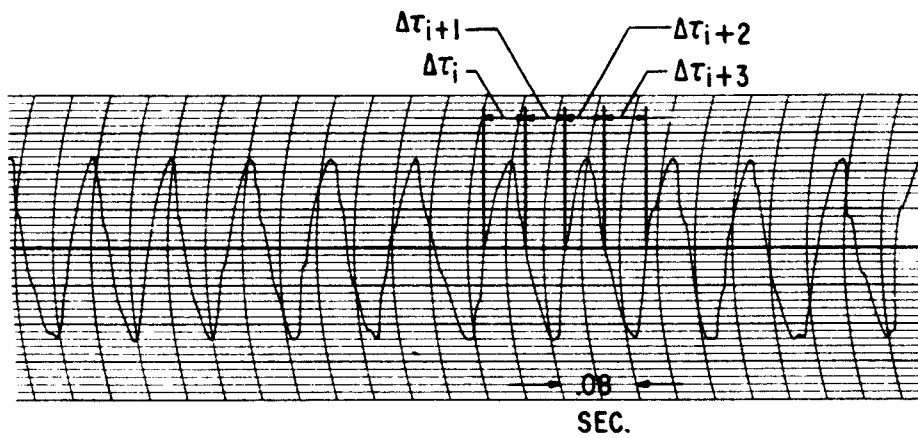

Fig. 8 Recording of direct beat note between free running oscillator and maser. A numerical analysis of these recordings could also be run to determine the power spectrum.

6. REFERENCES

1. J. A. Barnes and L. E. Heim, "A High Resolution Ammonia Maser Spectrum Analyser", to be published.
2. W. R. Bennett, "Methods of Solving Noise Problems", Proc. IRE 44, (1956).
3. Of course, many traces of the spectrum may be taken for the purpose of obtaining an ensemble average, and this would perhaps provide a more direct relation to the preferred definition based on the ensemble average (Eq. (8)).
4. In fact the width of these sharp peaks is less than 1 cps. It is not yet certain whether this crystal oscillator is the more stable or the maser is the more stable generator. At the present time it is fashionable to consider the maser the more stable.
5. This oscillator was designed and constructed by A. H. Morgan and his group at the National Bureau of Standards. The quartz crystal was made at the Bell Telephone Laboratories.
6. R. B. Blackman, and J. W. Tukey, The Measurement of Power Spectra , (Dover Publications, New York, 1958).
7. H. S. Black, Modulation Theory, (D. Van Nostrand Co., Inc., New York, 1953), p. 195.
8. W. L. Everitt, "Frequency Modulation", Trans. Am. Inst. Elec. Engrs., 59, 613 (Nov. 1940).

APPENDIX

As an example of the effect of frequency multiplication on an FM signal consider just one stage of multiplication. Assume that the current, $I(t)$, in the output tank of the multiplier is related to the input voltage, $V(t)$, by the transfer function, $g(V)$, which is a function of the input voltage; i. e. ,

$$I(t) = g(V(t))V(t) . \tag{1}$$

If the input signal is of the form

$$V(t) = V_0 \cos \phi(t) , \tag{2}$$

where $\phi(t)$ is some function of time, then the current becomes

$$I = g(V_0 \cos \phi) V_0 \cos \phi .$$

Since $\cos \phi$ is an even function of ϕ , $g(V_0 \cos \phi)$ is also an even function of ϕ , and therefore I is an even function of ϕ . Therefore I can be expanded as a Fourier cosine series in ϕ ; i. e. ,

$$I = \sum_{n=0}^{\infty} a_n \cos n\phi . \tag{3}$$

To restrict the case to a simple FM wave, let

$$\phi(t) = \omega_0 t + \delta \sin \omega_m t \tag{4}$$

where
and
yield

about
given

Typical
bandwidth
The
usual

factor
unchanged

of a
multiplier

where ω_o is the carrier frequency, ω_m is the modulating frequency, and δ is the modulation index. Substitution of Eq. (4) into Eq. (3) yields,

$$I(t) = a_o + a_1 \cos(\omega_o t + \delta \sin \omega_m t) + \dots \\ + \dots + a_N \cos(N\omega_o t + N\delta \sin \omega_m t) + \dots$$

If the impedance, $Z(\omega)$, of the output tank is sufficiently peaked about $\omega = N\omega_o$, but broader than $2N\delta\omega_m$, the output voltage, $V'(t)$, is given approximately by

$$V'(t) \approx a_N Z(N\omega_o) \cos(N\omega_o t + N\delta \sin \omega_m t) \quad (5)$$

Typically ω_m is very much smaller than ω_o and the condition that the bandwidth of the output tank is greater than $2N\delta\omega_m$ is easily satisfied. The condition that $Z(\omega)$ is sharp enough to reject $(N - 1)\omega_o$ and $(N + 1)\omega_o$ usually requires N to be less than 10.

Eq. (5) shows that the modulation index is multiplied by the factor of frequency multiplication and the frequency of modulation is unchanged. Extensive use is made of this fact in FM transmitters.^[8]

Figure 4a shows the square root of the power spectrum, $(\sqrt{P(\omega)})$, of a signal while Figures 4b and 4c show the same signal after being multiplied in frequency by 3 and 9 respectively.