

COMPARISON OF TWO-WAY SATELLITE TIME TRANSFER AND GPS COMMON-VIEW TIME TRANSFER BETWEEN OCA AND TUG

D. Kirchner and U. Thyr
Technical University Graz, Austria

H. Ressler and R. Robnik
Space Research Institute, Graz, Austria

P. Grudler, F. Baumont, and Ch. Veillet
Observatoire de la Côte d'Azur, Grasse, France

W. Lewandowski
Bureau International des Poids et Mesures, Paris, France

W. Hanson, A. Clements, J. Jespersen, D. Howe, and M. Lombardi
National Institute of Standards and Technology, Boulder, U.S.A.

W. Klepczynski, P. Wheeler, W. Powell, and A. Davis
U.S. Naval Observatory, Washington, U.S.A.

P. Uhrich, R. Tourde, and M. Granveaud
Laboratoire Primaire du Temps et des Fréquences, Paris, France

Abstract

For about one year the time scales UTC(OCA) and UTC(TUG) were compared by means of GPS and two-way satellite time transfer. At the end of the experiment both links were independently "calibrated" by measuring the differential delays of the GPS receivers and of the satellite earth stations by transportation of a GPS receiver and of one of the satellite terminals. The results obtained by both methods differ by about 3 ns, but reveal a seasonal variation of about 8 ns peak-to-peak which is likely the result of a temperature-dependence of the delays of the GPS receivers used. For the comparison of both methods the stabilities of the timescales are of great importance. Unfortunately during the last three months of the experiment a less stable clock had to be used for the generation of UTC(TUG).

INTRODUCTION

The GPS common-view technique presently provides the best operational means for comparing remote time scales with high precision and nanosecond accuracy [1]. In the future this will change with Selective Availability (SA) turned on. The degradation caused by SA can only be overcome by strict procedural standardization, and if necessary, the use of post-processed ephemerides. Of great

importance for the obtainable accuracy is the knowledge of the receiver delays. The differential delay of the receivers can be measured by receiver transportation.

Two-way time transfer via communication satellites using spread-spectrum techniques is capable of 100 ps precision but needs transmit and receive satellite terminals at both stations which have to work together in pairs [2]. Accuracies of nanosecond or even subnanosecond level are expected by calibration of the station delays by means of portable satellite terminals.

Through the cooperative efforts of several laboratories both methods have been implemented at the Observatoire de la Cote d'Azur (OCA), Grasse, France, and the Technical University Graz (TUG), Austria, allowing the comparison of these two state-of-the-art techniques over a period of nearly one year. Apart from other reasons OCA and TUG were chosen because at that time these stations were the only ones able to work with LASSO (Laser Synchronization from Stationary Orbit), the third technique capable of nanosecond accuracy. Due to various reasons no time transfer with that accuracy could be obtained despite successful LASSO sessions at both stations [3].

First results of the comparison between the GPS and two-way links have already been published [4]. The experiment was concluded by an independent "calibration" (measurement of the differential delays) of the GPS receivers and two-way stations by transportation of a GPS receiver and one of the satellite terminals. In the following the final results including the "calibration" will be given.

BASICS OF TWO-WAY

The two-way technique is used for point-to-point time transfer of highest precision and accuracy. Both laboratories need receive and transmit stations in order to exchange timing information via communication satellites employing pseudo noise (pn) coded signals and code division multiple access (CDMA). The measurement consists of simultaneous time interval measurements at both sites in which the one-pulse-per-second (1 PPS) generated by the local clock starts both the local time interval counter and, transmitted via the satellite, stops the remote time interval counter. The time difference $T1 - T2$ between the clocks of both stations is given by the following equation [2]:

$$\begin{aligned}
 T1 - T2 &= 1/2(C1 - C2) \\
 &+ 1/2[(d1U + d2D) - (d2U + d1D)] \\
 &+ 1/2(d12 - d21) \\
 &+ dR \\
 &+ 1/2[(d1TX - d1RX) - (d2TX - d2RX)]
 \end{aligned} \tag{1}$$

The first term of the right hand side of equation (1) is given by the difference of the counter readings of station 1 and 2 which have to be exchanged to compute the clock differences. The second term contains the differences of the sums of the signal delays in the uplink and downlink for both signal directions. Under the assumption of path reciprocity this term cancels out. This assumption is likely to hold to better than 100 ps for simultaneous transmissions at Ku-band frequencies [5]. The third term contains the difference of the transponder delays in both directions and is also zero when employing the same transponder in both signal directions. In the case of different transponders for both signal directions, the transponder delay difference has to be known. The fourth term is a correction for the path nonreciprocity caused by the earth rotation (Sagnac effect). It can be

computed from the positions of the earth stations and the satellite without requiring the knowledge of these positions with high accuracy. The last term is given by the difference of the differential delays of the transmit part and receive part (station delays) of earth station 1 and 2. The knowledge of these station delay differences mainly determines the accuracy of the time comparison.

The delay difference of both stations can be measured by means of a third station used as a transfer standard or by collocation of both stations involved. For the latter case one obtains [6]:

$$(d1TX - d1RX) - (d2TX - d2RX) = C2 - C1 \quad (2)$$

with the right hand side of equation (2) being the difference of the counter readings obtained during collocation of the stations.

EXPERIMENT CONFIGURATION AND EQUIPMENT

Each of the time scales UTC(OCA) and UTC(TUG) is generated by a single atomic clock. Fig. 1 shows the frequency and time distribution and measurement set-up at OCA and Figs. 2 and 3 present the same for TUG. UTC(OCA) has been generated by a HP 5061A opt. 004 (CS 560) using the internal clock module. UTC(TUG) was first generated by a HP 5061A opt. 004 (CS 1654) and after its sudden break-down (January 14, 1991) by a HP 5061A (CS 524) and using an external clock module (DDC 6459) for the generation of the 1 PPS.

The on-site GPS receiver at OCA has been an Allen Osborne TTR-5 SN053 and at TUG an original NBS receiver (NBS SN03) has been operated together with a Stanford Telecommunications Inc. TTS-502B SN04. At the beginning of the experiment TTR-5 and NBS 03 differed concerning the use of Block II satellites but this effect was removed by a software update which has been in use since December 12, 1990. An Allen Osborne TTR-6 SN0262 was used as a portable receiver in order to measure the differential delay of the on-site receivers, thus enabling an absolute comparison of UTC(OCA) and UTC(TUG) by means of GPS. For this purpose in both stations also the delay between UTC(Lab) and the 1 PPS used as time reference (1 PPS Ref) for the portable receiver has to be measured.

In the beginning the two-way measurements were carried out via the SMS (Satellite Multi-Service) transponder of the European communication satellite EUTELSAT I-F2 and since October 16, 1990 via the SMS transponder of EUTELSAT I-F4 both at a nominal position of 7°E.

The satellite earth stations used were the permanent station of TUG at the Observatory Lustbühel Graz and a temporary station at OCA of the VSAT type [6], which was then used as a portable station to measure the differential delay of the stations necessary for the absolute two-way comparison of UTC(OCA) and UTC(TUG). The main characteristics of both stations are given in Table 1.

To obtain a nominal carrier-to-noise power density ratio (C/N_o) of 55 dBHz at both stations, according to EUTELSAT link budget calculations OCA transmitted with its maximum EIRP and TUG with about 2 dB more than OCA to compensate for the smaller G/T of the OCA station. A block diagram of the two-way set-up employed at OCA and of that at TUG including the transported OCA station and thus also showing the configuration used for the measurement of the differential delay, is given in Figs. 1 and 3, respectively. Because of the allocated frequency of 14022.0 MHz for transmission and a frequency of 12522.0 MHz for reception resulting from the

nominal satellite translation frequency of 1500 MHz, which turned out to be very stable, no problem was caused by the limited frequency agility of the VSAT [6,7].

	TUG	OCA
Location	15° 30'E 47° 04'N 480 m MSL	06° 55'E 43° 45'N 1260 m MSL
Usage	various experiments	time transfer only
Antenna:		
Diameter	3 m	1.8 m
Mount	steerable	fixed
Max. EIRP	72 dBW	49 dBW
G/T	23 dB/K	21 dB/K
Frequency agility:		
Independence of up and down conversion	yes	no
Synthesizer step-size	100 Hz	1 MHz

Table 1 Main characteristics of the TUG and OCA earth stations.

At both stations MITREX modems [8,9] of the original type were used. The modems require 5 or 10 MHz as a reference frequency to internally generate the 1 PPS which is then modulated onto the pn-sequence (derived from the same reference frequency) for transmission. The internally generated 1 PPS (PPS TX) can be synchronized with the reference 1 PPS (1 PPS Ref) by an internal synchronization circuit or by employing an external device as done at TUG [10]. In contrast to the basic two-way procedure outlined in the previous chapter where the 1 PPS generated by the station clock starts the local counter and is transmitted to the remote station, in the actual set-up the local counter is started by a 1 PPS generated by the station clock the so-called reference 1 PPS (1 PPS Ref), but the transmitted pulse (PPS TX) is generated by the MITREX modem. Therefore in each station the delay between UTC(Lab) and the 1 PPS Ref and the delay between the 1 PPS Ref and the PPS TX have to be measured in addition to the actual time transfer measurements, during which the counter is started by the 1 PPS Ref and stopped by the received 1 PPS called PPS RX. Using this procedure the start input of the counter is always connected to the 1 PPS Ref and the stop input is connected to a PPS coming from the MITREX thus the configuration of each counter input can be set to best fit the employed signals and does not have to be changed. The stability of the 1 PPS Ref is given by the stability of the frequency standard, the clock and the time distribution system and that of the PPS TX by the stability of the frequency standard, the frequency distribution system and the divider and synchronization circuits of the MITREX. Both stations first used counters of the type HP 5370A, later (from March 20, 1991, on) a HP 5370B was used at OCA until the end of the experiment.

MEASUREMENTS

Two-way comparisons began on a regular basis on June 22, 1990, ended on October 10 and restarted on November 9 lasting to April 17, 1991. The interruption resulted from a break-down of the

receive part of the OCA station caused by humidity in the transmit reject filter oozing through an improperly sealed waveguide connection and required disassembly and reassembly of the driver unit.

A schedule of three sessions per week (Monday, Wednesday and Friday) each lasting from 12:00 to 12:30 UTC was used. Initially each session consisted of two measurement blocks of four minutes duration, each consisting of 240 individual measurements 1 s apart, starting at 12:15 and 12:20 UTC, respectively, and from July 30, 1990, of two minutes duration starting at the same times. Two minutes of data have been found sufficient in earlier experiments to obtain good average values of the time transfer [11]. Since November 9, 1990, a third two minutes block was performed starting at 12:27 UTC whereby the counter at OCA was started by the PPS TX instead of the 1 PPS Ref. In this measurement scheme the stability of the start pulse does not depend on the stability of the clock module, but on that of the MITREX divider and synchronization circuits. On the other hand it requires trigger level adjustment of the start input of the counter. This additional measurement was introduced because it turned out that the jitter of the clock module used to generate UTC(OCA) was rather large (700 ps). Before and after the time transfer measurements several measurements were carried out to determine the delay between 1 PPS Ref and PPS TX. Furthermore also the MITREX P-signal and Delta-f-meter readings were recorded giving an indication of changes in the received signal power and the deviation of the center frequency of the received signal from the nominal 70 MHz, respectively [10]. However no deviations were recorded which would cause a modem delay change exceeding 200 ps. In order to study the stability of the measurements over longer periods on August 20, 22 and 24, 1990 and March 27 and 29, 1991 only one block per session, but lasting about twenty minutes, was carried out [4]. The measurement of the differential delay of the stations was performed on April 23 and 24, 1991, with one measurement block (12:25 to 12:28 UTC) on the first day and on the second day three measurement blocks lasting four minutes and starting at 12:05, 12:10 and 12:15 UTC and a fourth block of 19 minutes duration beginning at 12:40 UTC.

The delay between UTC(Lab) and the 1 PPS Ref for the two-way measurements and the delay between UTC(Lab) and the 1 PPS Ref for the GPS measurements were measured at TUG at the beginning of the experiment and during the MITREX and GPS delay comparisons and at OCA the final measurements of these delays were carried out after the experiment.

At TUG the same trigger level was used for the start and stop channel of the counter throughout the experiment and also at OCA until September 19, 1990. Then OCA changed the start and stop trigger levels after using a different stop trigger level on September 21 and 24. During the third session both trigger levels were the same. During the collocation of the stations on April 23 and 24 the OCA counter was adjusted for the usual start and stop trigger levels, but for the last block another start trigger level was used.

GPS measurements have been carried out for years at OCA and TUG using the European common-view schedules issued by the Bureau International des Poids et Mesures (BIPM). Thus at the beginning of the experiment schedule No. 15 issued on June 12, 1990, was used. This schedule includes Block I and Block II satellites. The daily distribution of the 13 minutes tracks (32 per day) is shown in Fig. 4 revealing the changing and gradually degrading configuration of tracks around the two-way measurements. Therefore starting with December 19 for OCA and TUG a special schedule (48 tracks per day) including the European schedule No. 16 was introduced and used until the end of the experiment (see Fig. 5).

The delay comparisons between TTR-5 and NBS 03 by means of TTR-6 were carried out in the

time frame March 30 until May 21 starting (March 30 to April 8) and ending (May 16 to May 21) with comparisons between TTR-6 and the on-site receiver (TTR-5 SN051) of the Paris Observatory (OP). The comparisons at OCA were performed during the period April 11 to 19 and April 30 to May 15 and that at TUG during the period April 22 to 27.

DATA PROCESSING AND RESULTS

Nearly all GPS data were common-view data in the strict sense but also tracks with a maximum tolerance of 4 minutes were used. All time comparisons were referred to the midpoints of the tracks and restricted to tracks with elevation angles greater than 10° and a standard deviation below 20 ns. Furthermore all satellites reported as unusable by the U.S. Naval Observatory (USNO) including Block II satellites with SA [1] on were discarded and also all tracks between August 5, 7:22 and August 10, 8:06 were not used because they were not valid due to receiver problems at OCA. The average standard deviation of the 13 minutes tracks for OCA and TUG was about 5 ns and 4 ns, respectively.

In order to derive the two-way time differences $UTC(TUG) - UTC(OCA)$, in a first step for each measurement block the expected value – referred to the midpoint of the block – of a linear regression through the second-to-second differences divided by two and the standard deviations were computed.

Fig. 6 depicts the standard deviations of all-sessions including the sessions performed at TUG in order to measure the differential delay. The values which are higher than the usual ones (on average 0.8 ns until February) for a given period of time are caused by outliers in the measurements of OCA and TUG or in several cases of OCA only because of the rather large jitter of the 1 PPS Ref at OCA. This can be seen from the data of each station by computing a second order regression and studying the residuals and also from the generally smaller standard deviations of the third block (at OCA PPS TX starts the counter) until the change over from the high performance clock to the standard clock at TUG (dashed vertical line in Fig. 6). The larger standard deviations of all measurement blocks on December 10 are explained by the presence of an unknown carrier within the allocated two-way frequency band. The gradual increase of the standard deviations beginning with February is probably due to a degradation of the performance of the satellite link. For the data actually used outliers were eliminated from the two minutes sessions using a window of ± 3 ns around the expected value. But using all data of a measurement block or only the data with outliers removed yielded at a maximum a difference of 0.16 ns for the expected value of the block.

The midpoint value was corrected by the differences $(1 \text{ PPS Ref} - \text{PPS TX})$ measured in both stations. For each session a mean of the $(1 \text{ PPS Ref} - \text{PPS TX})$ measurements each consisting of a block of hundred measurements 1 s apart was computed. The average standard deviation of these blocks of hundred measurements at TUG and OCA was 0.06 ns and 0.7 ns, respectively. The higher standard deviations at OCA results from the poor performance of the clock module used at OCA. For the first two blocks of a session this correction is given by $1/2[(1 \text{ PPS Ref} - \text{PPS TX})TUG - (1 \text{ PPS Ref} - \text{PPS TX})OCA]$ and for the third block (counter started by PPS TX at OCA) the correction is $[1/2(1 \text{ PPS Ref} - \text{PPS TX})TUG - (1 \text{ PPS Ref} - \text{PPS TX})OCA]$. No further correction for the third block is required because the cable which was used between the start input of the counter and the PPS TX of the modem was of the same length as that used between the stop input and the PPS RX.

Using the data thus obtained Fig. 7 shows the difference UTC(TUG) - UTC(OCA) obtained by GPS and two-way (without corrections for the GPS and two-way differential delays) after removing all time steps (OCA: Oct. 20, 20 μ s; TUG: Dec. 19, 9 μ s and Jan. 14, 274 ns) and a slope of 117.88 ns per day before the clock change at TUG and a slope of 159.88 ns per day after the change. The dashed vertical lines in this and following figures indicate the change of the schedule and of the clock at TUG.

The result of the GPS receiver delay comparisons performed at OP, OCA and TUG is given in Table 2 [12].

Laboratory	Date	No. of tracks	Mean ¹ ns	Std. Dev. ns
OP	Mar. 30 - Apr. 7	292	-0.9	2.3
OCA	Apr. 12 - Apr. 15	154	17.6	2.0
TUG	Apr. 23 - Apr. 26	158	10.3	2.0
OCA	May 1 - May 12	452	15.7	1.6
OP	May 17 - May 20	147	-1.8	2.2

¹This is the mean of [UTC(Lab) - GPS-time]TTR-6 - [UTC(Lab) - GPS-time]Lab given by the single tracks.

Table 2 Results of the differential delay measurements obtained by transportation of GPS receiver TTR-6.

According to the values given in Table 2 (using the mean of the data obtained at OCA) the difference UTC(TUG) - UTC(OCA) obtained from the uncorrected GPS data has to be corrected by -6.4 ns. The uncertainty estimated from the repeated comparisons at OP and OCA is 1.5 ns [12].

The result of the delay comparison of the two-way stations performed at TUG is given in Table 3.

Date	No. of Measurements	Mean ns	Std. Dev. ns
Apr. 23	128	-81.37	1.2 ¹
Apr. 24 (Block 1 - 3)	720	-81.04	1.0
Apr. 24 (Block 4)	1140	-81.41 ²	1.0

¹VSAT not optimally pointed

²This value is already corrected for the different trigger levels used (see chapter MEASUREMENTS)

Table 3 Differential delay of the two-way stations obtained by station collocation at TUG. The overall mean is -81.3 ns.

In order to obtain UTC(TUG) - UTC(OCA) via two-way the data already corrected by (1 PPS Ref - PPS TX) have to be corrected further by the differential delay of the stations being -81.3 ns and by the difference (UTC(Lab) - 1 PPS Ref) of both stations being 307.7 ns. Finally the correction for the Earth rotation (Sagnac effect) amounting to -22.2 ns has to be applied. This results in a total two-way correction of 204.2 ns.

Considering the change of the trigger level of the counter at OCA (see chapter MEASUREMENTS) a correction of 1 ns has to be applied to the data of September 21 and 24 and one of 3 ns to the

data before September 21. Unfortunately these offsets caused by the change of the trigger levels were not measured but can be estimated from the shape of the pulses involved with an uncertainty of about 0.5 and 1 ns, respectively.

Fig. 8 shows UTC(TUG) - UTC(OCA) via GPS and via two-way for a period of five days after applying all of the above corrections. Evidently the GPS data have to be smoothed and interpolated to get GPS time transfer results concurrent with the two-way measurements.

In order to find the degree of smoothing to be applied to the GPS data to smooth the measurement noise without smoothing out the clock noise, Allan variances from the data shown in Fig. 7 were computed (see Fig. 9). The MITREX points with two minutes sampling time were computed from two minutes smoothed data obtained from the long measurement blocks performed in August 1990 and March 1991. Also shown in Fig. 9 are the Allan variances computed from the data presented in Fig. 11 (difference between [UTC(TUG) - UTC(OCA)] measured by two-way and GPS). The data were further analysed by computation of the modified Allan variance [13] revealing white-noise PM for the data marked by slope = -1. For the two-way minus GPS measurement results this applies to an averaging time of about 60 days. The smoothing time obtained for the period comparing the two high performance clocks (CS 1654 and CS 560) is about 8 hours and that for the period comparing the standard clock with the high performance clock is about 1 hour. For appropriate sections of the data different smoothing and interpolation techniques including Vondrak smoothing combined with Lagrange interpolation - routinely used at BIPM for GPS data processing - were applied, but gave about the same results. The problem is that before the change of the tracking schedule there were stable clocks, but for most of the time there was only a small number of GPS tracks near the time of the two-way measurements and that after the change very soon at TUG one had to switch over to a less stable clock. Thus only a short intermediate period represents the ideal situation of stable clocks and many GPS tracks near the time of the two-way measurements. Considering the facts given above the GPS data were smoothed by the computation of the means for the given smoothing periods of eight hours and one hour around the two-way measurements, using the data with the mean difference of the clock rates already removed. The result obtained for [UTC(TUG) - UTC(OCA)]MITREX - [UTC(TUG) - UTC(OCA)]GPS is given in Fig. 10. The lower trace in this figure indicates the number of tracks per smoothing period. The choice of the smoothing periods used was confirmed by using other smoothing periods which gave a larger scatter of the data especially for longer smoothing times during the period with the standard clock.

After the repair CS 1654 was reconnected to the measurement system on January 17, 1991. This means a comparison with the other TUG clocks every hour and at GPS measurement times and a continuous phase recording (0.5 ns resolution) with CS 524. It was thus possible to replace CS 524 by CS 1654 in the computations of the two-way and GPS differences. Using CS 1654 and eight hour smoothing (from January 22, 1991) instead of CS 524 and one hour smoothing shows the same long term behaviour of the data as in Fig. 10, but less scatter (see Fig. 11).

At TUG temperature, humidity and air pressure are recorded every hour and for all GPS measurements. The daily outside temperature at TUG for 12 UTC is shown in Fig. 12 and that at OCA for the days of two-way measurements is shown in Fig. 13. Also given (Fig. 14) is the differential delay of the two GPS receivers permanently operated at TUG.

ANALYSIS OF RESULTS AND CONCLUSION

The data presented in Figs. 10 and 11 show the agreement between UTC(TUG) - UTC(OCA) obtained by two-way and UTC(TUG) - UTC(OCA) obtained by GPS after having independently "calibrated" (measurement of the differential delays of the two-way and GPS equipment) both comparison methods at the end of the experiment.

Estimates of the time comparison accuracy obtained by GPS can be found in the literature [1]. For distances up to 1000 km and station coordinates known to better than 30 cm and no difference in receiver software one obtains for a single common-view track about 9 ns and for 10 common-view tracks (one day average) about 3.4 ns assuming an uncertainty of the relative receiver delay of 2 ns, but without considering contributions caused by the noise of the station clocks and the rise time of the reference pulses. The OCA-TUG baseline is about 800 km and the GPS antenna coordinates of both stations are known with an uncertainty of 10 cm in the ITRF-88 [14].

An attempt of an error budget for the two-way time transfer is given in Table 4.

UTC(Lab) - 1 PPS Ref Counter	0.5 ns
MITREX	0.5 ns
Earth station delay (relative)	1.0 ns
Transponder delay (relative) ¹	1.2 ns
Satellite link (Ku-band)	0.0 ns
Sagnac effect	0.1 ns
Total	0.1 ns
	1.7 ns

¹ The same frequency band of one transponder is used for both signal directions

Table 4 Error budget for the two-way time transfer (about 100 measurements 1 s apart). Possible contributions due to coherence among signals are not considered here [15].

Because the two-way minus GPS differences exhibit white-noise PM up to an averaging time of about 60 days (see chapter DATA PROCESSING AND RESULTS) the computation of the mean is justified for data intervals up to this length. The means of the last 28 and 56 days computed from the data shown in Figs. 10 and 11 are given in Table 5.

Data	Date	No. of Measurements	Mean ns	Std. Dev. ns
Fig. 10	Mar. 20 - Apr. 17	28	3.3	4.3
	Feb. 18 - Apr. 17	59	3.2	3.4
Fig. 11	Mar. 20 - Apr. 17	28	3.7	3.2
	Feb. 18 - Apr. 17	59	3.1	2.5

Table 5 Difference of [UTC(TUG) - UTC(OCA)] measured by two-way and GPS after having independently "calibrated" both links.

The result is in good agreement with the total uncertainty estimate of the GPS and two-way delay comparisons. The mean computed over the full data length is 3.6 ns for both data sets.

Comparing Figs. 10 and 11 with Figs. 12 and 13 reveals an obvious correlation between the long term behaviour of the difference of $[\text{UTC}(\text{TUG}) - \text{UTC}(\text{OCA})]$ obtained by two-way and GPS and the outside temperature recorded at TUG and OCA. For the duration of the experiment the data given in Figs. 10 and 11 can well be approximated by third order polynomials. The residuals from these polynomials fitted to the data (solid line) have a standard deviation of 3.3 ns (Fig. 10) and 2.6 ns (Fig. 11), respectively. The peak-to-peak variation is about 8 ns.

Different contributions causing the temperature-dependent behaviour are conceivable, but the main contribution is most likely explained by a different temperature behaviour of the GPS receivers used. This becomes even more evident from Fig. 14, which shows the differential delay of the two GPS receivers permanently operated at TUG. Using TTS-502B instead of NBS 03 for the time comparison between TUG and OCA reduces the temperature dependence by about 20 percent (see dashed line in Fig. 10).

The experiment allowed to compare the accuracies of the two most accurate time transfer methods nowadays in operation and demonstrated the feasibility of earth station delay comparison by means of a portable station. The main problem in the comparison of both methods resulted from the clock noise and therefore for future experiments addressing this question the most stable clocks and a well balanced GPS tracking schedule should be used. Furthermore all equipment employed should be checked carefully before the experiment to detect a possible systematic behaviour affecting the measurement accuracy. Concerning the temperature-dependence of the delays of the outdoor units (antenna, preamplifier/mixer, cable) of the GPS receivers this could be done in a temperature chamber using a GPS signal simulator. GPS receiver delay comparisons by receiver transport should be repeated in course of the experiment in order to check the consistency of the measurements and it would be advisable to operate more than one GPS receiver at each site. Also the delays of the two-way systems should be compared several times and the satellite terminals should preferably be adapted to detect delay variations by use of local means such as a satellite simulator. By selecting appropriate equipment and careful operation the first four contributions to the error budget given in Table 4 may be reduced by at least a factor of three leading to a two-way accuracy of about 0.5 ns. Similar accuracies are expected for GPS using geodetic receivers and ultra-precise ephemerides [1].

ACKNOWLEDGMENTS

The loan of a MITREX modem by Professor Ph. Hartl, University of Stuttgart, is deeply appreciated. The support of this experiment by EUTELSAT in providing three month of transponder time free of charge and the help of Mr. S. Fiedler and Mr. M. Chabrol (EUTELSAT) and Mr. J. Meunier and Mr. C. Bacot (France Telecom) and Mr. W. Schladofsky (ÖPTV) in administrative and technical matters are gratefully acknowledged. The work was supported by Bureau Nationale de Métrologie, France and the Austrian Academy of Sciences and the Jubilee Fund of the Austrian National Bank.

REFERENCES

- [1] W. Lewandowski and C. Thomas, "GPS time transfer", Proc. IEEE, vol. 79, pp. 991-1000, 1991.
- [2] D. Kirchner, "Two-way satellite time transfer via communication satellites", Proc. IEEE, vol. 79, pp. 983-990, 1991.
- [3] C. Veillet et al., "LASSO, two-way and GPS time comparisons: A (very) preliminary status report", in Proc. 22nd Annual PTTI Meeting, 1990, pp. 575-582.
- [4] P. Uhrich et al., "Preliminary comparison of time transfer via Lasso, GPS and two-way satellite", in Proc. 5th European Frequency and Time Forum, 1991, pp. 96-104.
- [5] D.W. Hanson, "Fundamentals of two-way time transfer by satellite", in Proc. 43rd Annual Symp. on Frequency Control, 1989, pp. 174-178.
- [6] D.A. Howe, "Ku-Band satellite two-way timing using a very small aperture terminal (VSAT)" in Proc. 41st Annual Symp. on Frequency Control, 1987, pp. 147-160.
- [7] D. Kirchner, "Design considerations for Ku-band two-way satellite time transfer terminals", in Proc. 4th European Frequency and Time Forum, 1990, pp. 631-637.
- [8] Ph. Hartl, N. Gieschen, K.M. Müssener, W. Schäfer, and C.M. Wende, "High accuracy global time transfer via geosynchronous telecommunication satellites with MITREX", Journ. of Flight Sciences and Space Research, vol. 7 (5), pp. 335-342, 1983.
- [9] P. Hartl et al., "MITREX 2500, a modem for microwave time and ranging experiments via telecommunication satellites", Inst. of Navigation, Univ. Stuttgart, 1985.
- [10] H. Ressler and D. Kirchner, "Experience with the MITREX modem", Technical Univ. Graz, Dept. of Comm. and Wave Prop., Int. Rep. INW 8501, 1985.
- [11] W.J. Klepczynski, P.J. Wheeler, W. Powell, J. Jeffries, A. Myers, R.T. Clarke, W. Hanson, J. Jespersen, and D. Howe, "Preliminary comparison between GPS and two-way satellite time transfer", in Proc. 42nd Annual Symp. on Frequency Control, 1988, pp. 472-477.
- [12] W. Lewandowski, "Determination of differential time corrections between the GPS time receivers located at the Observatoire de Paris, the Observatoire de la Côte d'Azur and the Technical University of Graz", Rapport BIPM-91/6, 1991.
- [13] D.W. Allan, "Time and frequency metrology: Current status and future considerations", in Proc. 5th European Frequency and Time Forum, 1991, pp. 1-9.
- [14] W. Lewandowski, "High accuracy ground-antenna coordinates for GPS time transfer", in Proc. IAG Symposium G2-Permanent Satellite Tracking Networks for Geodesy and Geodynamics, Vienna, August 1991, in press.
- [15] D.A. Howe, "Time tracking error in direct sequence spread-spectrum networks due to coherence among signals", IEEE Trans. on Comm., vol. 38, pp. 2103-2105, 1990.

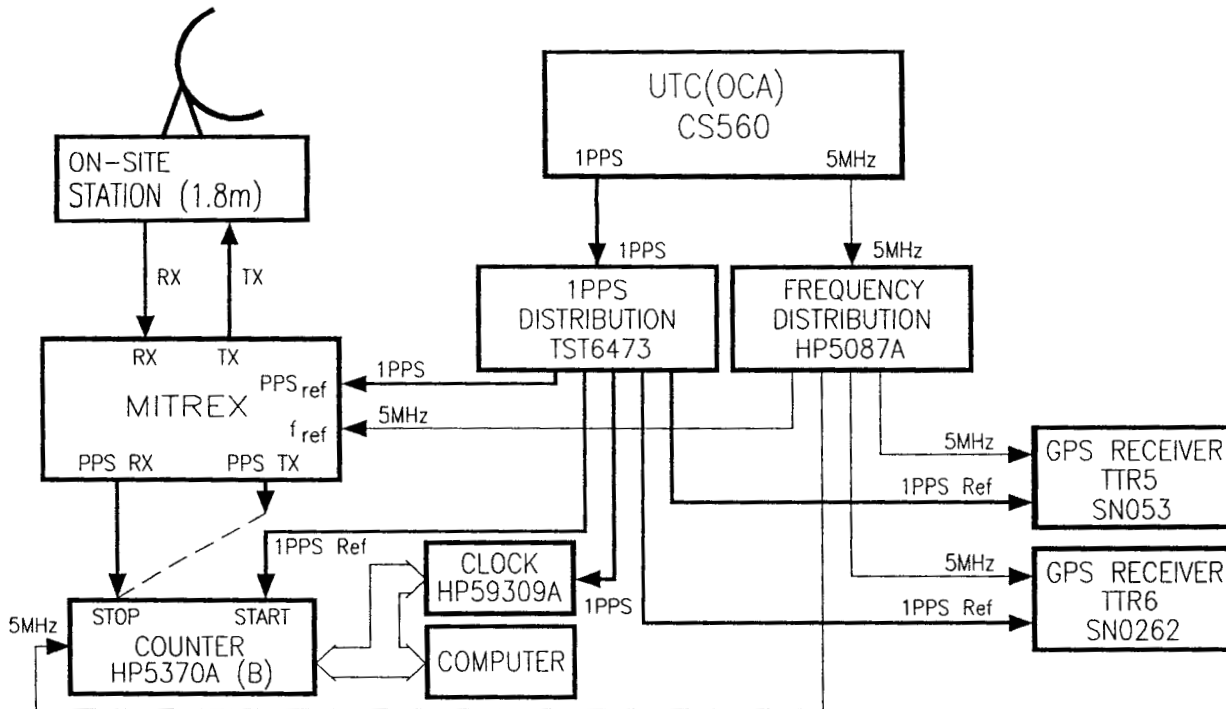

Fig. 1 Frequency and time distribution, as well as GPS and two-way set-up at OCA.

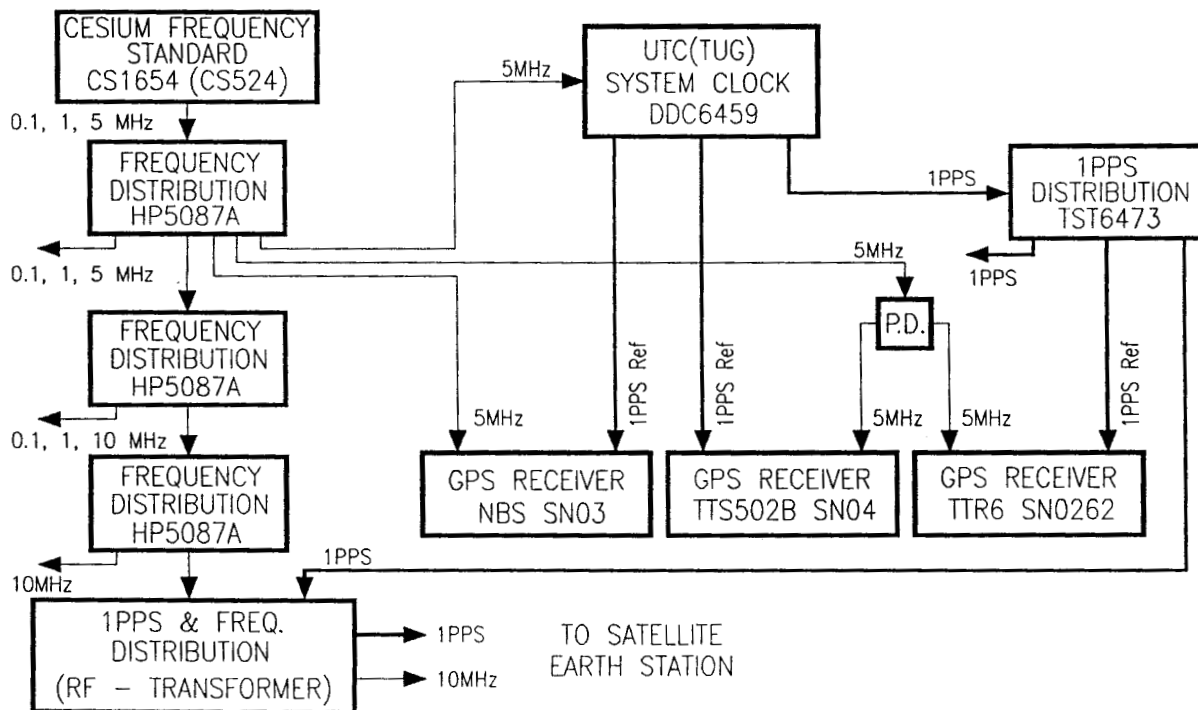

Fig. 2 Frequency and time distribution, as well as GPS set-up at TUG.

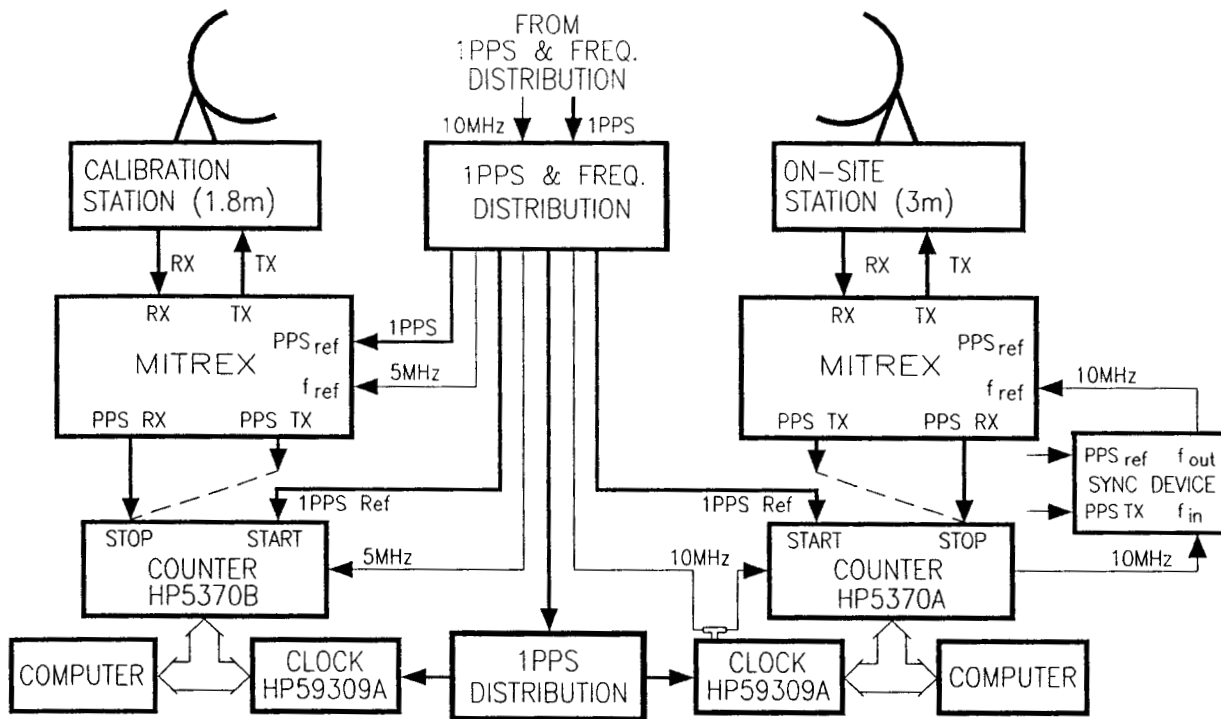

Fig. 3 Two-way set-up at TUG including the transported OCA station.

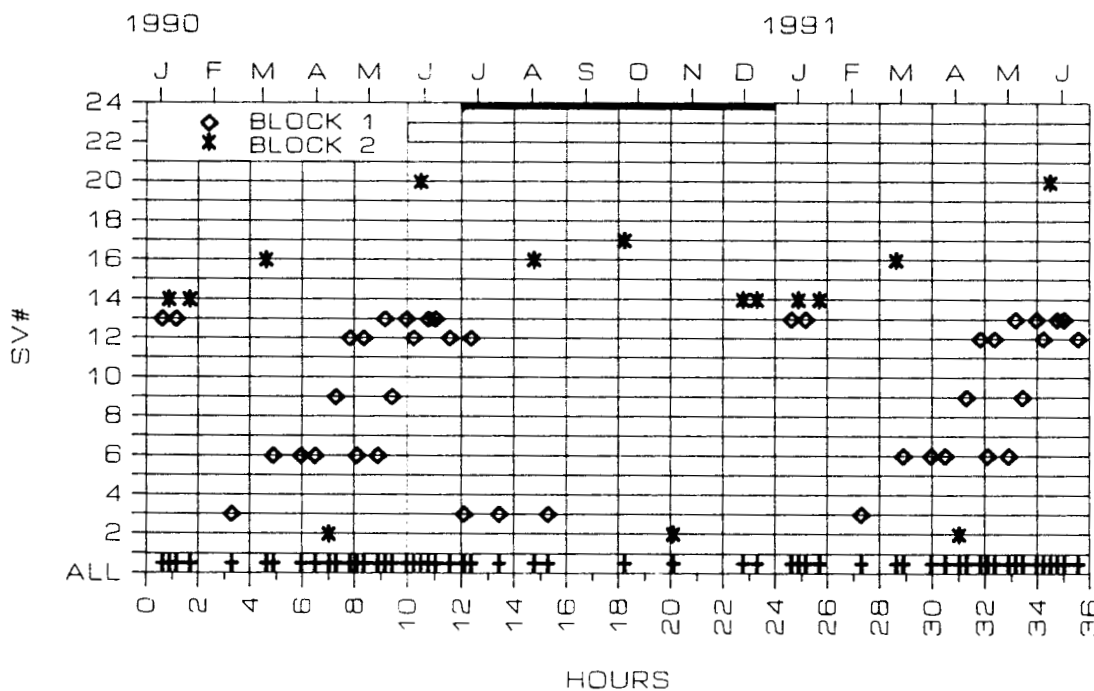

Fig. 4 European schedule No. 15. The ticks for the months given at the top are centered at the two-way measurement times.

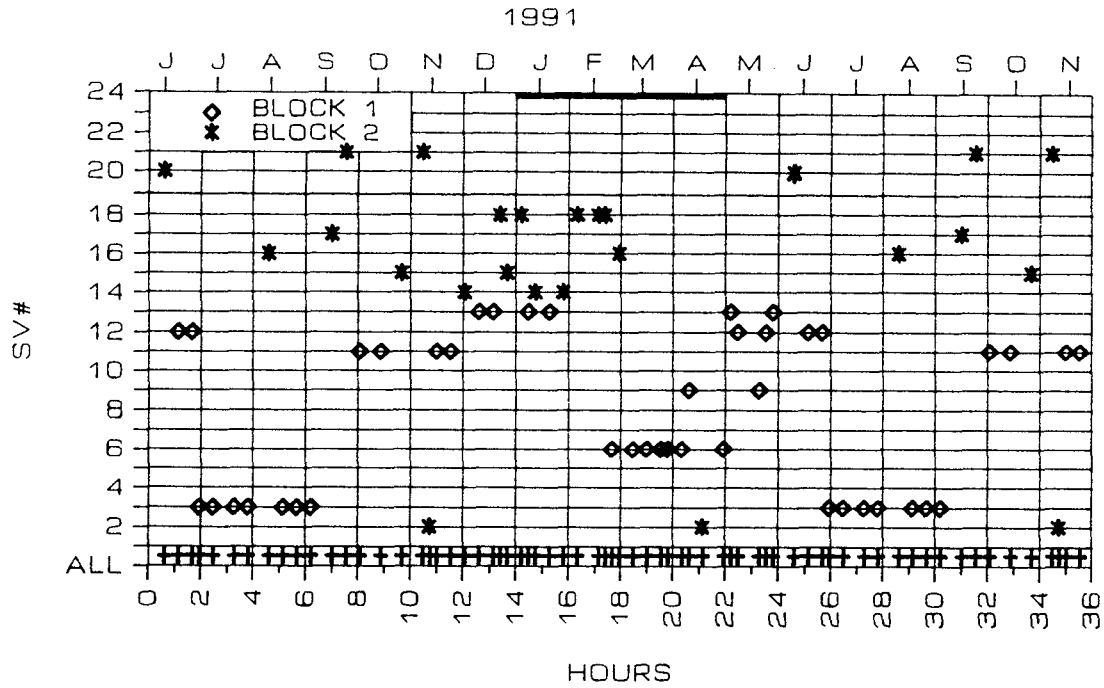

Fig. 5 Special OCA and TUG schedule including European schedule No. 16 valid since December 19, 1991.

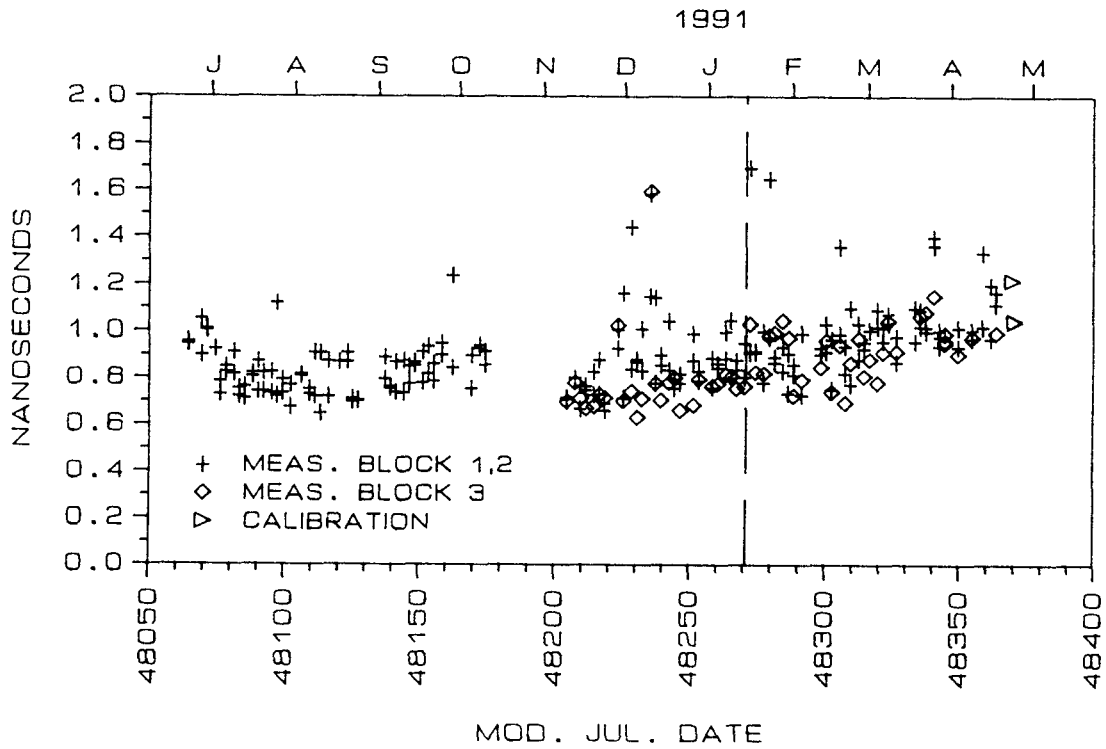

Fig. 6 Standard deviations of all two-way sessions including the sessions for delay comparison.

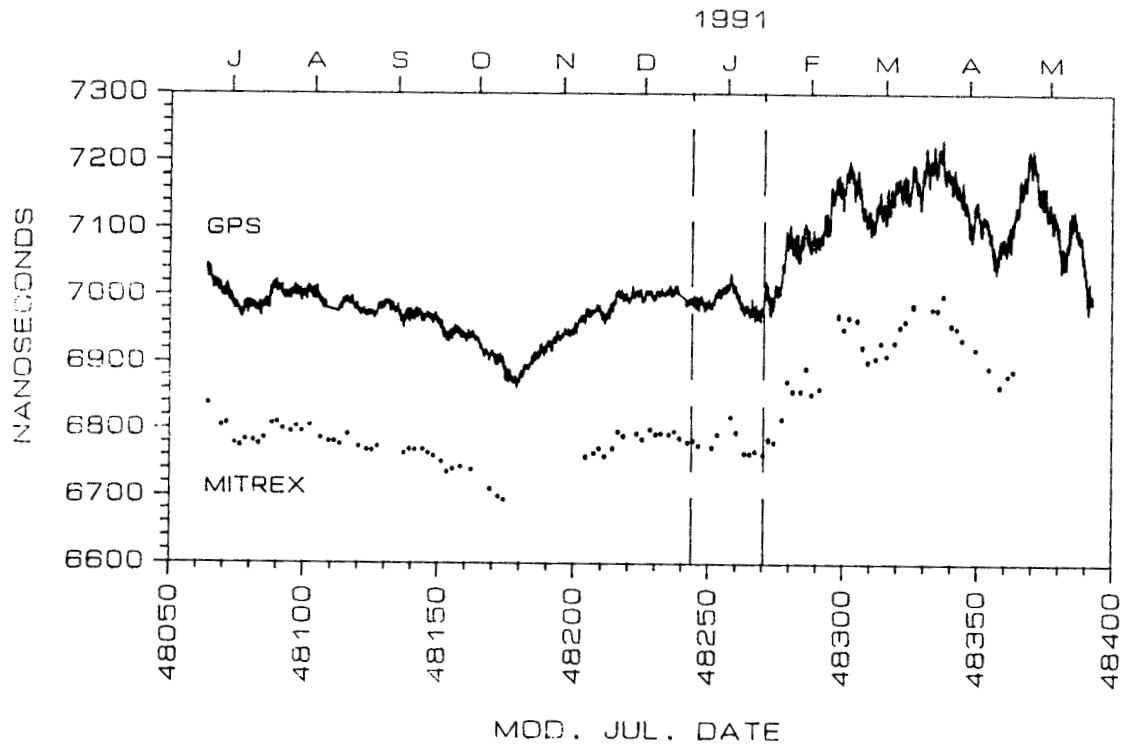

Fig. 7 UTC(TUG) - UTC(OCA) by GPS and two-way (corrected for 1 PPS Ref - PPS TX) after removal of all time steps and the mean difference of the clock rates.

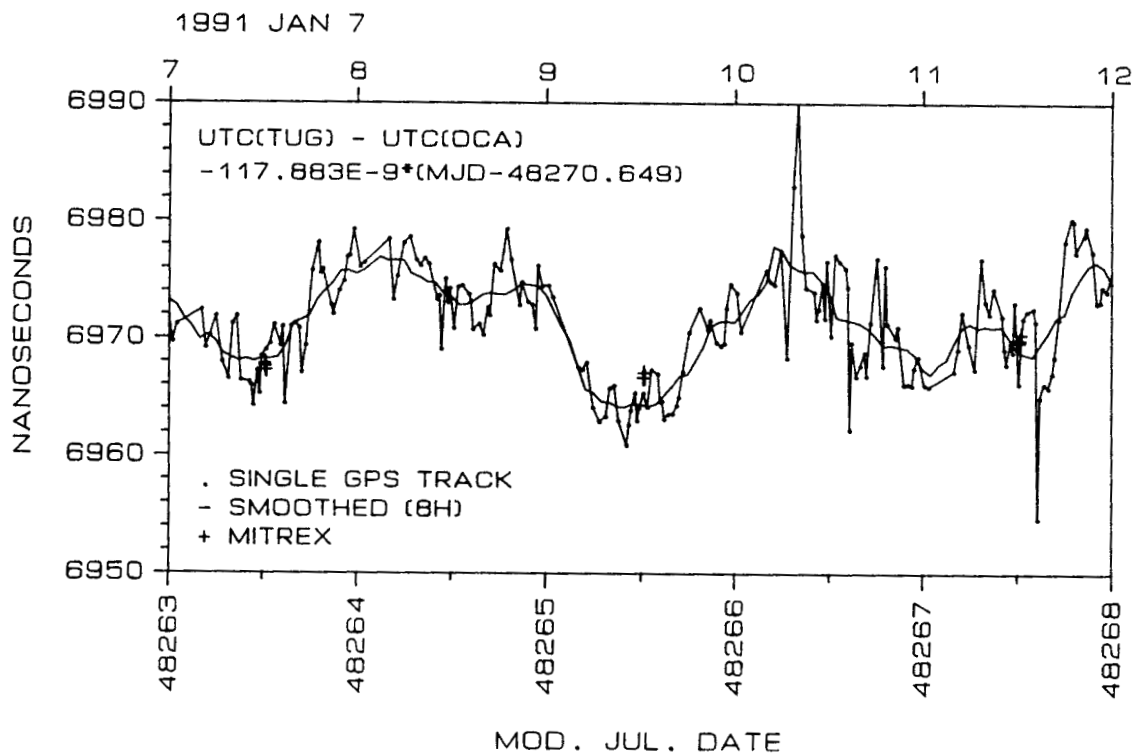

Fig. 8 GPS raw and smoothed data (eight hour mean) and two-way data for a period of five days (all corrections applied).

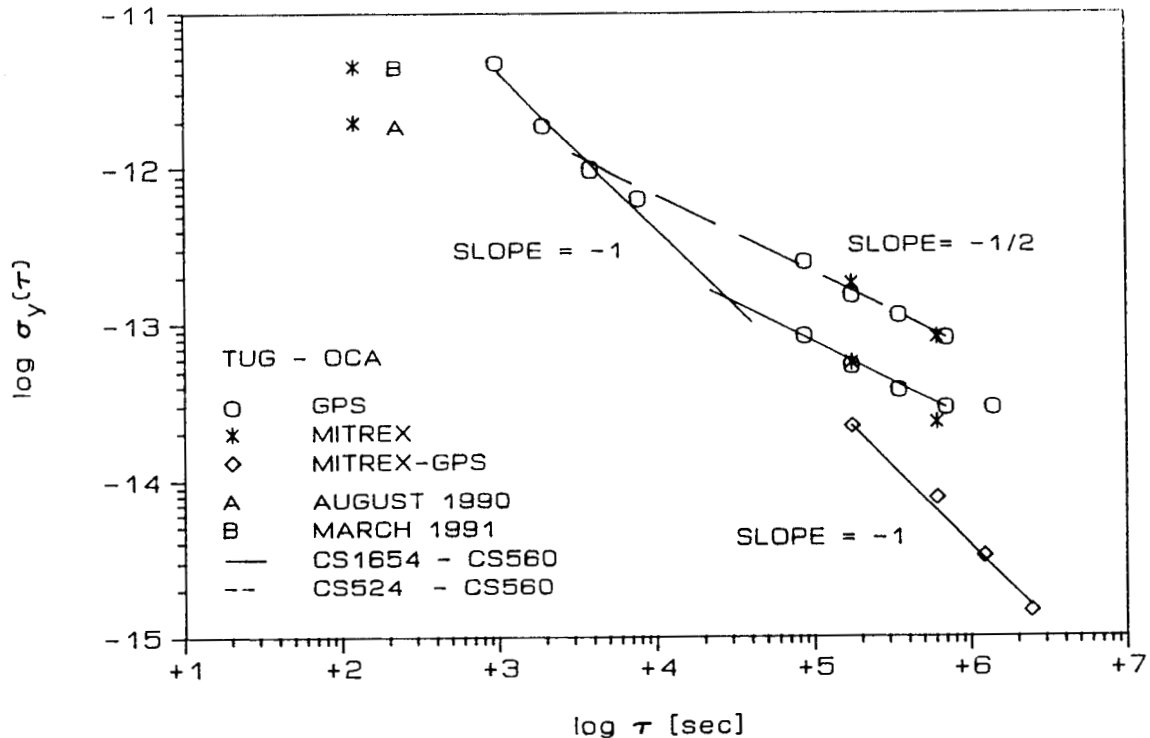

Fig. 9 Square root of the Allan variance of the GPS and two-way comparisons between UTC(TUG) and UTC(OCA).

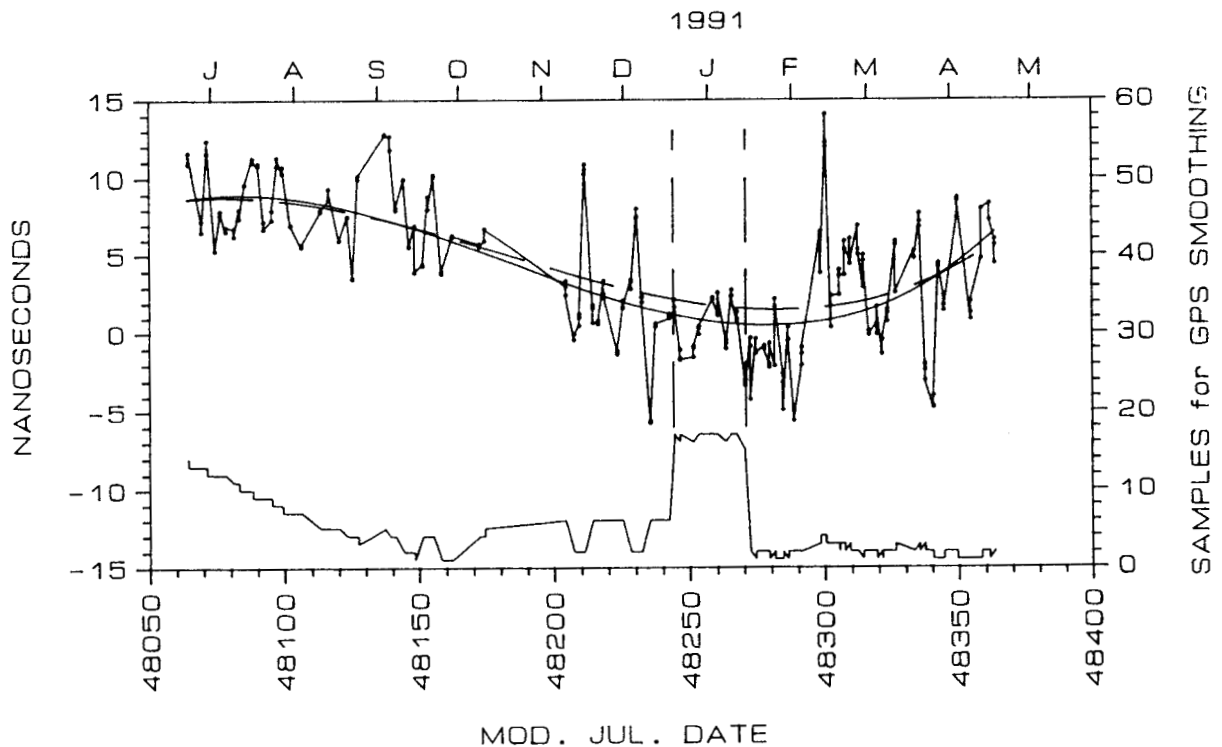

Fig. 10 Difference between [UTC(TUG) - UTC(OCA)] measured by two-way and GPS, and number of tracks per smoothing period.

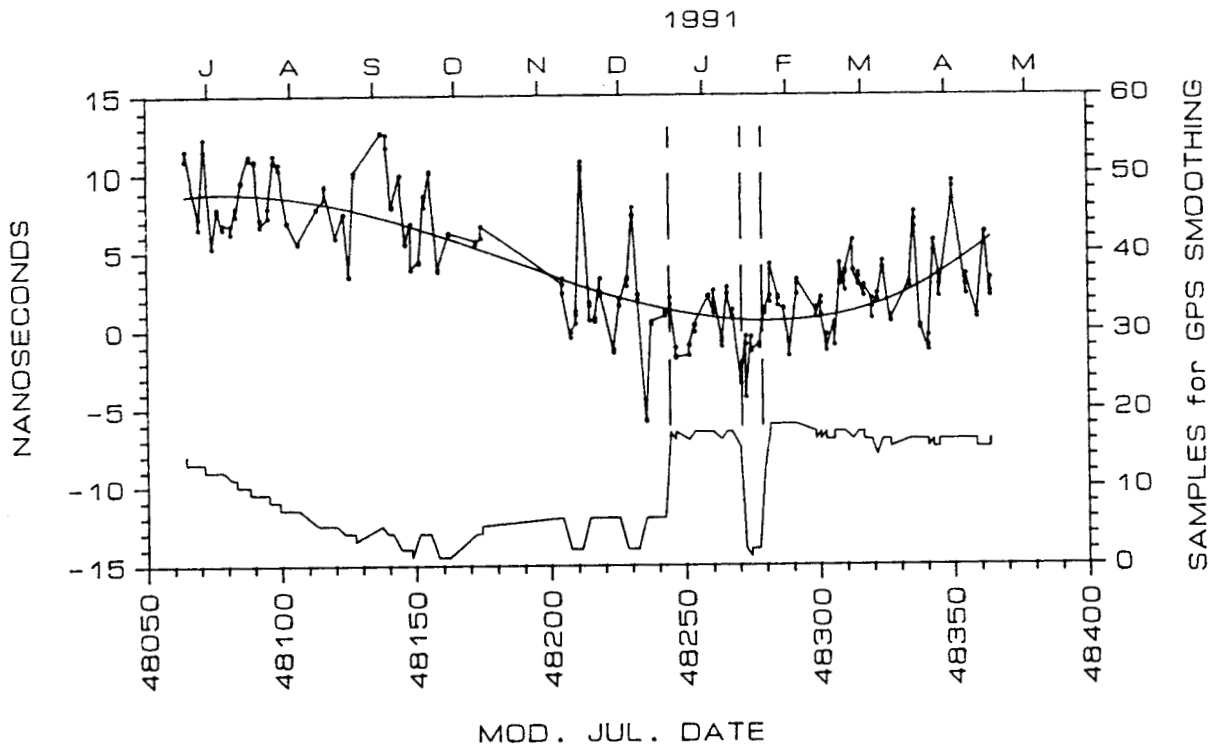

Fig. 11 Same as Fig. 10, but from January 22, 1991, on referred to CS 1654.

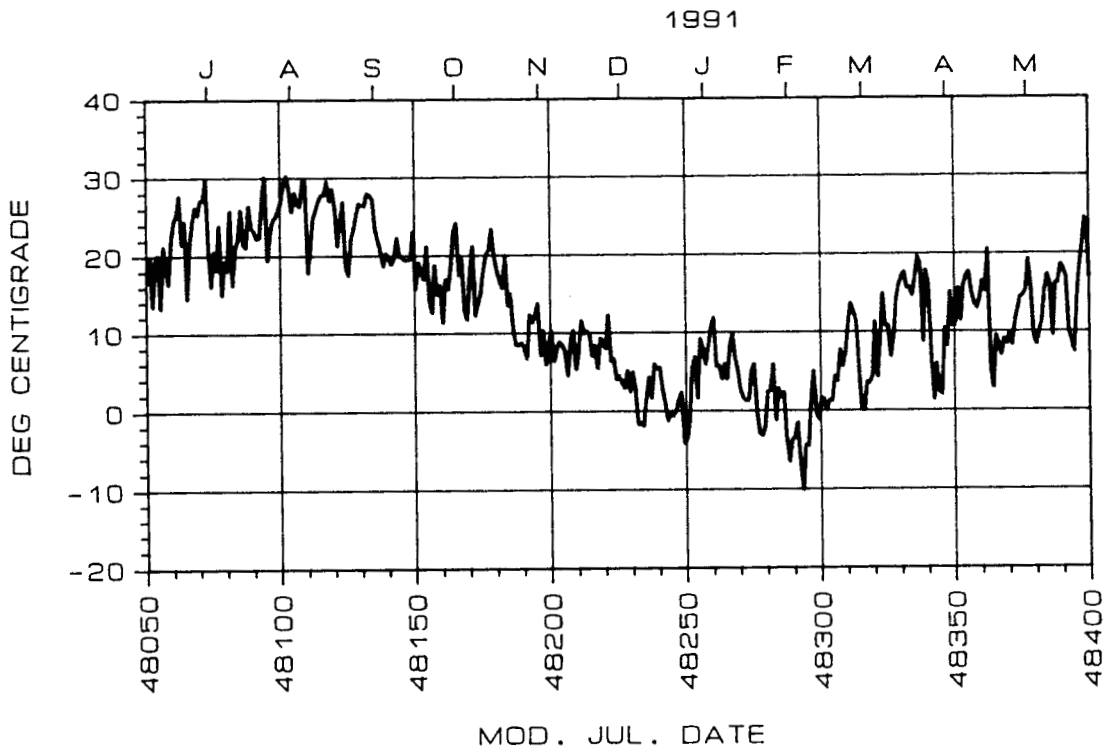

Fig. 12 Outside temperature at TUG (12 UTC).

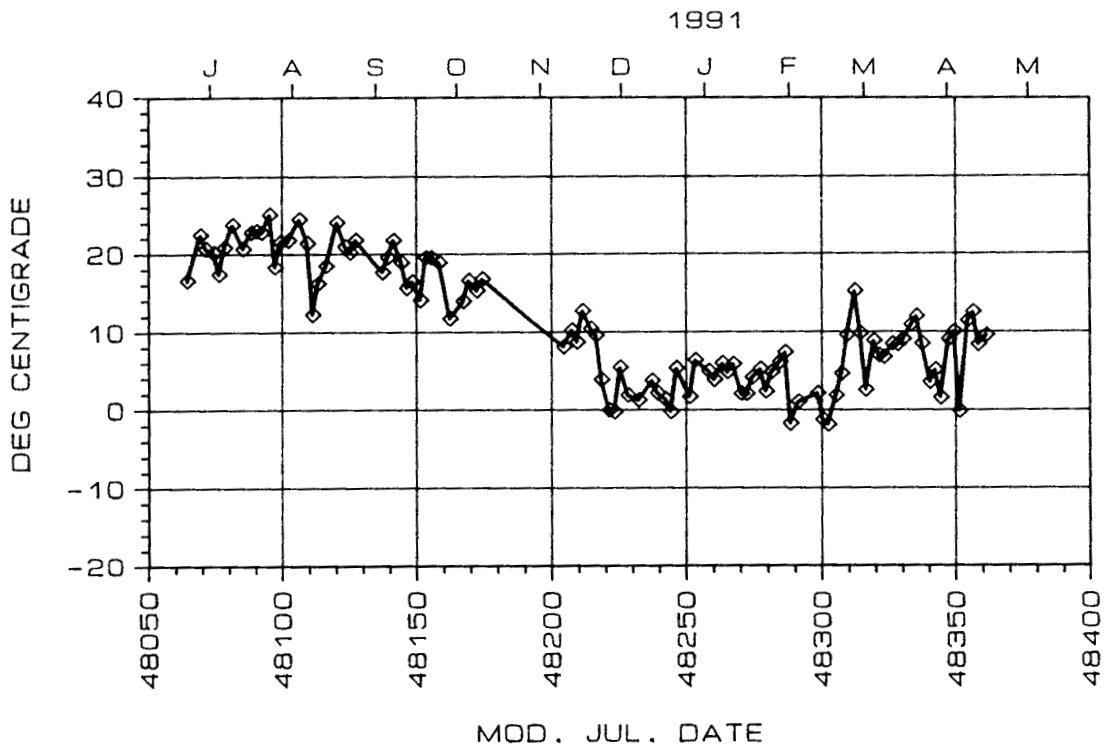

Fig. 13 Outside temperature at OCA (12 UTC).

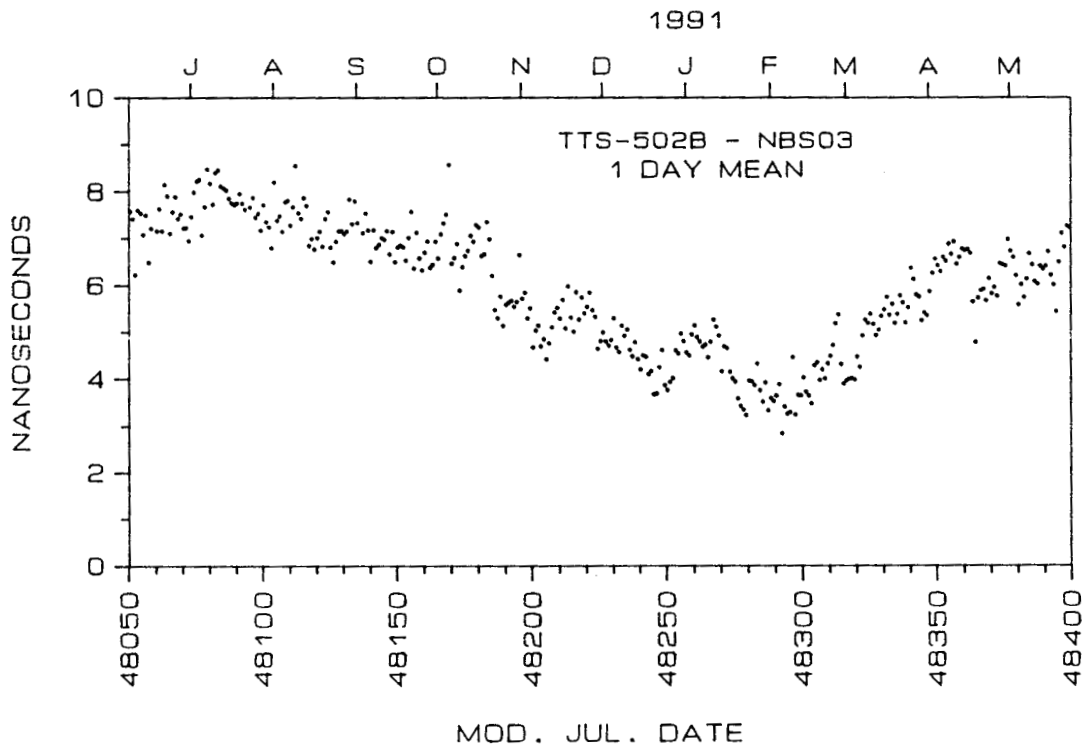

Fig. 14 Differential delay (daily mean) of TTS-502B and NBS 03.