

Effect of Vibration on PM and AM noise of Oscillatory and Non-oscillatory Components at 10 GHz

A. Hati*, C. W. Nelson, and D. A. Howe, *Member, IEEE*

National Institute of Standard and Technology
Boulder, CO, USA

*archita@boulder.nist.gov

Abstract—The performance of microwave components is sensitive to vibrations to some extent. Among them, microwave cables and connectors, bandpass filters, mechanical phase shifters and some nonlinear components are the most sensitive. The local oscillator is one of the prime performance-limiting components in microwave systems ranging from simple RF receivers to advanced radars. The increasing present and future demand for low acceleration sensitive oscillators, approaching $10^{-13}/g$, requires a re-examination of sensitivities of basic nonoscillatory building block components under vibration. The purpose of this paper is to study the phase-modulation (PM) noise performance of an assortment of oscillatory and nonoscillatory microwave components under vibration at 10 GHz. We point out some challenges and provide suggestions for accurate measurement of vibration sensitivity of these components. We also study the effect of vibration on the amplitude-modulation (AM) noise.

I. INTRODUCTION

High-precision oscillators have significant applications in modern communication and navigation systems, radars, and sensors mounted in unmanned aerial vehicles, helicopters, missiles, and other dynamic platforms. These systems are gaining usage in the tens of gigahertz microwave spectrum and must meet their performance requirements even when subjected to severe dynamic environmental conditions. In most applications the acceleration experienced by a microwave oscillator is in the form of vibration, which can introduce mechanical deformations that deteriorate the oscillator's otherwise low phase-modulation (PM) noise [1]-[3]. This degrades the performance of the entire electronic system that depends on this oscillator's low phase noise.

The acceleration sensitivity of an oscillator originates most commonly from deformations induced by acceleration in the frequency-determining element, the resonator. The resonant frequency of a resonator depends on its dimensions, thus mapping any changes in size to frequency. Vibration also mechanically deforms non-frequency-determining electronic components that then cause phase fluctuations [4], [5]. In general, these effects are more prominent in higher-frequency oscillators, due to increased signal phase sensitivity to mechanical deformation and decreased resonator quality

Work of US government, not subject to copyright. Commercial products are identified in this document only for complete technical description; no endorsement is thereby implied.

factor. If these phase fluctuations are inside the oscillator feedback loop, they convert to frequency fluctuations via Leeson's effect [6] within the resonator half-bandwidth. In recent years, resonator and oscillator frequency sensitivity to vibration has improved to a point where the phase sensitivity of nonoscillatory components cannot be overlooked [7]-[11]. Coaxial cables and connectors, bandpass filters, mechanical phase shifters, and amplifiers are the most sensitive components, particularly at microwave frequencies [5], [12]. The increasing present and future demand for low vibration-sensitive oscillators, approaching $10^{-13}/g$ (1 g is the acceleration of gravity near the earth's surface, approximately 9.8 m/s^2), requires a re-examination of sensitivities of basic nonoscillatory building block components under vibration.

The purpose of this paper is to study the performance of an assortment of oscillatory and nonoscillatory components under vibration normalized to a microwave frequency of 10 GHz. We first introduce the relation between acceleration sensitivity and phase noise in Section 2. In Section 3 we discuss the PM and AM noise measurement techniques, point out some challenges, and provide a few suggestions for accurate measurement in the presence of vibration. We also present AM and PM noise performance of some nonoscillatory components. In Section 4, we present the acceleration sensitivity results for different classes of oscillators, and finally a summary is given in Section 5.

II. ACCELERATION SENSITIVITY AND PHASE NOISE

An oscillator's sensitivity to vibration is traditionally characterized by acceleration sensitivity, which is the normalized frequency change per unit g. When an oscillator is subjected to acceleration, its resonant frequency shifts. The frequency shift, Δf , which is proportional to the magnitude of the acceleration and depends on the direction of acceleration, is given by a fractional-frequency change y as [1]

$$y = \frac{\Delta f}{f_0} = \vec{\Gamma} \cdot \vec{a}, \quad (1)$$

where f_0 is the frequency of the oscillator with no acceleration, $\vec{\Gamma}$ is the acceleration sensitivity vector and \vec{a} is the applied acceleration vector. When the direction of applied acceleration is parallel to the axis of the acceleration sensitivity vector, it

will have the greatest effect on Δf . For a low modulation index, the single sideband phase noise, $L(f_v)$ at any vibration frequency f_v is related to acceleration sensitivity as

$$L(f_v) = 20 \log \left(\frac{\vec{\Gamma} \cdot \vec{a}}{2f_v} f_0 \right) \text{ dBc/Hz}, \quad (2)$$

where dBc/Hz is decibels (dB) below the carrier in a 1 Hz bandwidth. Equation 2 may be rearranged to obtain

$$\Gamma_i = \frac{2f_v}{a_i f_0} 10^{(L(f_v)/20)}, \quad (3)$$

where Γ_i is the component of acceleration sensitivity vector in the i ($i = x, y$ or z) direction. For a sinusoidal vibration, $|\vec{a}|$ is the peak applied vibration level in units of g , and $L(f_v)$ is expressed in units of dBc. In most cases, the vibration experienced by an oscillator is random instead of sinusoidal. Under random vibration the acceleration is randomly distributed over a range of frequencies, phases, and amplitudes, and the acceleration is represented by its power spectral density (PSD). For random vibration, $|\vec{a}| = \sqrt{2PSD}$, and its unit is $g/\sqrt{\text{Hz}}$. Also, for a random vibration, $L(f_v)$ is expressed in units of dBc/Hz.

The sum of acceleration sensitivity squared in all three axes gives the total acceleration sensitivity, or gamma (Γ_{tot}), and is given by [13]

$$\Gamma_{tot} = \sqrt{\Gamma_x^2 + \Gamma_y^2 + \Gamma_z^2}. \quad (4)$$

Γ_{tot} of an oscillator can be calculated from (4) once the PM noise of the oscillator is measured for all three axes.

In this paper, the vibration or acceleration sensitivity of a nonoscillatory device is represented by Γ_{i-non} , which is given by

$$\Gamma_{i-non} = \frac{\sqrt{2}}{a_i} 10^{(S_\phi(f_v)/20)} = \frac{2}{a_i} 10^{(L(f_v)/20)} \text{ rad/g}, \quad (5)$$

where $S_\phi(f_v)$ is the double sideband phase noise and a_i is the peak acceleration.

III. EFFECT OF VIBRATION ON NONOSCILLATORY DEVICES AT 10 GHz

A. PM Noise

Fig. 1(a) is a block diagram of a PM noise measurement system used to measure the residual noise of a nonoscillatory device such as a bandpass filter or amplifier as well as a cable and connector under vibration. The output power of a reference oscillator is split into two paths. One path is used to drive the device under test (DUT) mounted to an actuator, and the other path is connected to a delay line. The delay is chosen so that the delay introduced in one path is equal to the delay in the other path. A phase shifter is used to set phase quadrature, or 90 degrees, between two paths, and the resulting signals are connected to a double-balanced mixer acting as a phase detector. The baseband signal at the output of the phase detector is amplified and measured on a fast Fourier transform

(FFT) analyzer. Because the delays in the two signal paths are equal, the PM noise from the reference oscillator is equal and correlated in each path and thus cancels [14]. At the output of the mixer, the noise from the vibrating DUT and its connecting cables appears because it is not correlated at the two inputs of the mixer. A low-noise phase detector and IF amplifier are chosen for this measurement, and their noise contributions are much lower than the dominating vibration-induced noise of the DUT and cables.

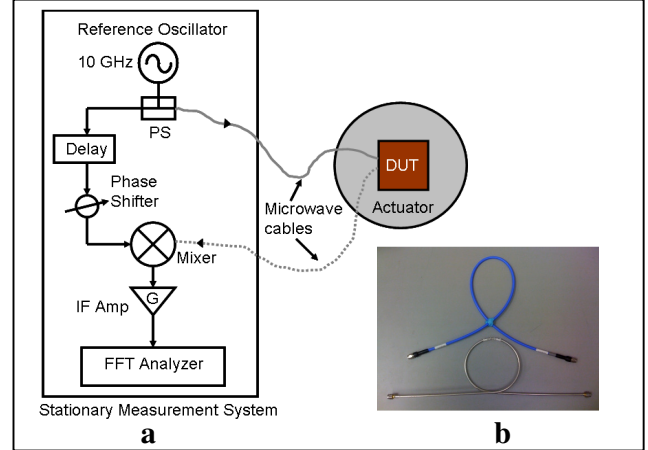

Fig. 1. (a) Block diagram of an experimental setup for residual PM noise measurement of components under vibration. PS – Power splitter, DUT – Device under Test, IF Amp – Intermediate Frequency Amplifier. (b) Typical cables used for vibration test.

1) Cable Considerations

In order to accurately measure the acceleration sensitivity of a DUT, it is important to know the noise floor of the measurement system. The main contributors to the vibration-induced PM noise floor are the coaxial cables (grey curves in Fig. 1(a)) connected between the stationary measurement system and the actuator. Under vibration, these cables flex, causing localized distortions in the coaxial structure that lead to modulations of the propagation parameters of the cable. Piezoelectric effects in coaxial cables can also be involved [15]. The main challenge is to obtain a reproducible low noise floor set by these flexing cables at close-to-carrier offset frequencies. For the noise floor measurement, the DUT is replaced by 8 cm long semi-rigid coaxial cable whose solid outer conductor diameter is 0.358 cm. The measured noise floor is very dependent on the configuration and tension of the cables running between the vibrating and stationary reference frames; small changes in the configuration may cause the noise to vary by anywhere from 10 dB to 30 dB. Also, the noise floor can vary significantly from one type and brand of cables to another. To test this, we measured the noise floor using a number of different types of cables available in the laboratory and noticed significant differences in the results. In Fig. 2, the residual PM noise results at 10 GHz of two cable types are shown. First the noise floor is measured with semi-rigid coaxial cables whose solid outer conductor diameter is 0.358 cm, each 46 cm long, represented by solid and dotted grey curves in Fig. 1(a). Then, one of the semi-rigid coaxial cables represented by the dotted grey curve is replaced with a braided-shield flexible coaxial cable of the same length and the

noise floor is measured again. Fig. 1(b) shows the picture of two cable types used for vibration tests. A random vibration profile of acceleration PSD of $1.0 \text{ mg}^2/\text{Hz}$ (rms) is used between $10 \text{ Hz} \leq f_v \leq 2000 \text{ Hz}$. This range of vibration frequencies is the range for our vibration table, adequately covering smaller ranges associated with most applications.

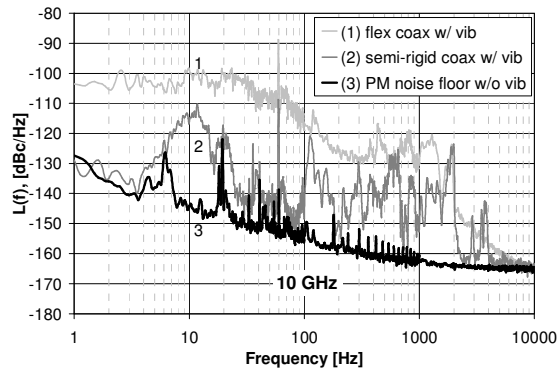

Fig. 2. Residual PM noise floor of the measurement system under vibration for semi-rigid coaxial and braided-shield, flexible coaxial. The DUT is replaced by 10 cm-long semi-rigid coaxial cable for this test. A random vibration profile of acceleration PSD = $1.0 \text{ mg}^2/\text{Hz}$ (rms) is used for $10 \text{ Hz} \leq f_v \leq 2000 \text{ Hz}$. The bottom curve shows the noise floor measured under no vibration. Narrow spurs are power-line EMI pick-up and should be ignored.

The results show that the noise floor can vary by 10 dB to 30 dB, depending on the cable types; therefore, extra care must be taken in selecting the cables for vibration-induced noise measurements. Different amounts of cable slack, tension and damping are used to obtain the best noise floor. Among the sample of coaxial cables tested, we find that the vibration sensitivity is lowest for the semi-rigid coaxial cable whose solid outer conductor diameter is 0.358 cm. Fig. 2 also indicates that the PM noise of vibrating cable is not flat with offset frequency. This may be due to a low-pass filtering effect of the dampening material on the overall mechanical frequency response.

2) DUT Considerations

Measuring the acceleration sensitivity of a DUT is challenging. For accurate measurements the following precautions should be taken:

- Experiment with different type of connecting cables as well as different amounts of cable slack or tension between the stationary and vibrating reference frames to obtain the best noise floor.
- Rigidly mount the DUT on the vibration table to avoid any mechanical resonance inside the frequency range of interest.
- Properly secure the cables to minimize flexing and strain due to vibration. It is also important to properly secure the power leads for the DUT.
- Reduce the acoustic noise and external vibration in the test area.
- The vibration actuator often has cooling fans; prevent this airflow from disturbing the connecting cables, DUT, or measurement-system components.
- No other components except the DUT and

accelerometer should be mounted on the shaker.

- If possible, use 1 to 3 dB attenuators at the connector interfaces to minimize the effect of voltage-standing-wave-ratio (VSWR) induced mechanical and multipath phase fluctuations [8].
- Ground loops interact with magnetic and electric fields generated by the vibrating actuator. Minimizing the ground loops is of utmost importance for accurate measurements.
- Check the noise floor between the measurements by replacing the DUT with a short cable.

After establishing a low noise floor, two 10 GHz bandpass cavity filters (BPF) of different quality factors (Q) as shown in Fig. 3(a) are tested under random vibration along the z-axis. The measured Q's of these two filters are approximately 3739 and 320. A random vibration profile of acceleration PSD $1.0 \text{ mg}^2/\text{Hz}$ (rms) for offset-frequency range 10 Hz to 2000 Hz is used. Fig. 4 shows the PM noise floor of the measurement system as well as the PM noise of the filters under vibration. The sensitivity of these filters to vibration is found to be very dependent on the amount of stress applied on them by the mounting fixture while securing them on the vibration table.

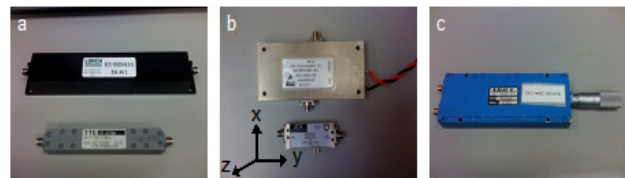

Fig. 3. Picture of the nonoscillatory components used for vibration tests at 10 GHz. (a) High-Q (3739) and low-Q (320) bandpass filters, (b) amplifiers, (c) phase shifter. Arbitrary x and y axes are chosen in the plane of the page, and the z-axis is normal to the device top surface.

The results presented in Fig.4 are the lowest obtained under certain conditions. The z-axis acceleration sensitivity of these filters, calculated from (5), is also indicated in Fig. 4. The result shows that the filter with higher Q (= 3739) is more sensitive to vibration. One possible reason is due to the fact that the transfer function phase of a high-Q filter has a steeper slope at its center frequency. Any vibration that modulates the resonant structure of the filter also modulates the center frequency and thus the phase shift through the filter. The phase slope is proportional to the filter Q; this causes the high-Q filter to be more sensitive to small mechanical distortions under vibration. However, the acceleration sensitivity does not necessarily depend solely on the Q of a filter. A cavity filter is a multi-pole or higher-order filter consisting of several resonators. These resonators are distributed in the filter network, each of which modulates the signal. The Q can be “increased” by increasing the number of resonators, which may make it more vibration sensitive. In other words, increasing the number of stages of a filter may increase the sensitivity to mechanical stress. Fig. 4 indicates the fact that that Q is not the only dominant factor in the filters’ vibration sensitivities. Since the phase noise difference between the two

BPF is ~ 17 dB, which is less than $20\log(3739/320) = 21.3$ dB, this means that structural effects such as the shape and size of the cavity housing and other mechanical processes are a playing role, either making the high-Q filter better than expected, or the low-Q filter worse than expected or a combination of both.

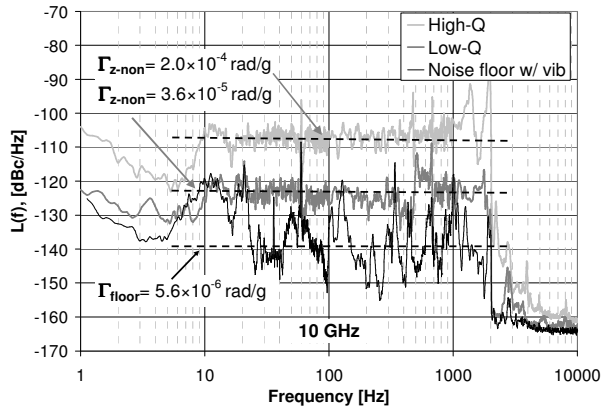
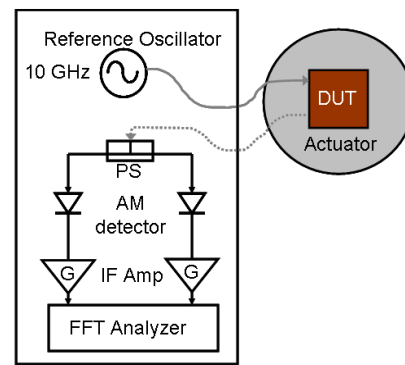

Fig. 4. PM noise of two 10 GHz bandpass cavity filters under vibration. A random vibration profile of acceleration PSD = $1.0 \text{ mg}^2/\text{Hz}$ (rms) is used for $10 \text{ Hz} \leq f_i \leq 2000 \text{ Hz}$. The bottom curve shows the PM noise floor set by flexing of cables under vibration. The z-axis acceleration sensitivities of high and low Q filters are respectively 2.0×10^{-4} rad/g [for $L(f) = -107$ dBc/Hz] and 3.6×10^{-5} rad/g [for $L(f) = -122$ dBc/Hz].

Finally, the PM noises of a few amplifiers and a mechanical phase shifter at 10 GHz are also measured under vibration. For these components, the PM noise is either lower than or equal to the noise floor of the connecting cables under vibration. As a result, an accurate measurement is not possible. However, it can be concluded from the experimental results that the acceleration sensitivity of the phase shifter and amplifiers under test is no greater than 5.6×10^{-6} rad/g, as shown in Fig 4.

B. AM noise

The flexing of coaxial cables due to vibration changes the structure of the cable, which not only modulates the phase of the transmitting signal but also modulates its amplitude [5]. However, unlike vibration-induced PM noise, the AM noise can be less of a problem because this effect can be reduced by amplitude compressing or clipping the signal. Fig. 5 shows a block diagram of the cross-correlated measurement system used to measure AM noise [14] of cables and filters under vibration. The output of the reference oscillator is fed to the DUT mounted on the actuator. The signal returning from the DUT is split into two paths, each containing the vibration-induced AM noise of the DUT and cables plus the AM noise of the stationary reference oscillator. These signals are fed to a two-channel, cross-correlation FFT analyzer. The advantage of this technique is that only the AM noise coherent to both channels, i.e., the noise of the oscillator, vibrating cables and DUT, averages to a finite value. The time average of the incoherent noise processes, such as the AM detectors and IF amplifiers, approaches zero as the number of averages used in cross-spectrum increases. An oscillator of very low AM noise is used for this test so as not to dominate the DUT noise.



Stationary Measurement System

Fig. 5. Block diagram of an experimental setup for AM noise measurement of components under vibration. PS – Power Splitter, DUT – Device under Test; IF Amp – Intermediate Frequency Amplifier.

First the DUT is replaced with a short semi-rigid coaxial cable, and the vibration-induced AM is measured for the same 46 cm-long semi-rigid and braided-shield flexible cables as those used for PM noise measurement. The vibration-induced AM noise is found to be negligible for semi-rigid cables; however, it is significant for braided-shield flexible cable. The AM vibration noise of flexible cable can be reduced by following it with a saturated amplifier. A stationary low-AM-noise amplifier in saturation is used before the power splitter, and a reduction of almost 20 dB is observed, as shown in Fig. 6. These results indicate that when selecting cables either for a vibration measurement or for low vibration-sensitive design, it is equally important to measure both vibration-induced AM and PM noise. Further nonlinear processing of the signal, such as mixing, may cause inadvertent AM-to-PM conversion of vibration-induced AM noise.

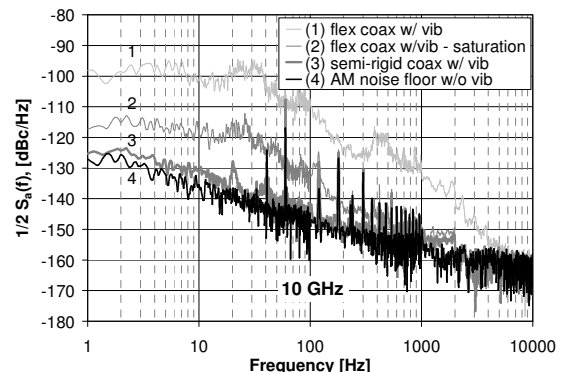

Fig. 6. AM noise floors of the measurement system for semi-rigid and braided shield flexible coaxial cable under vibration at 10 GHz. A random vibration profile of acceleration PSD = $1.0 \text{ mg}^2/\text{Hz}$ (rms) is used for $10 \text{ Hz} \leq f_i \leq 2000 \text{ Hz}$. The second curve from the top shows the reduction in vibration-induced AM noise after the signal is saturated by a stationary amplifier. $S_a(f)$ is the double sideband AM noise.

Next, the short semi-rigid coaxial is replaced by a DUT, in this case, bandpass cavity filters (Fig. 3(a)). The AM noise contribution of low-Q (320) filter is below the AM noise floor. Fig. 7 shows only the AM noise added by the high-Q (3739) filter under vibration. If this filter is used inside an oscillator loop, the effect of AM noise will be reduced significantly due

to saturation of the signal by the loop amplifier. However, in a system where the bandpass filter is used as a post-filter, often known as spectrum cleanup filter, under vibration such filters can amplitude-modulate the signals passing through them and add significant AM noise to a frequency source of low AM noise. Hence, these spectrum cleanup filters must be selected carefully in systems subject to vibration.

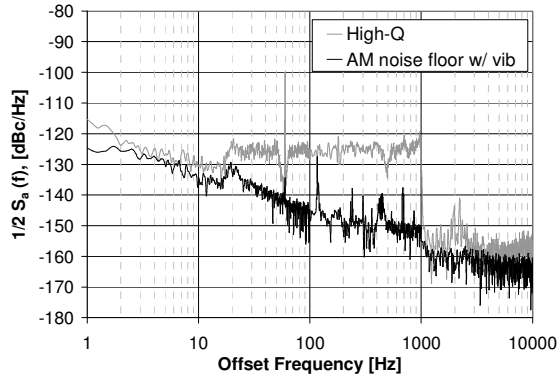

Fig. 7. AM noise performance of a bandpass cavity filter at 10 GHz under vibration. A random vibration profile of acceleration PSD = $1.0 \text{ mg}^2/\text{Hz}$ (rms) is used for $20 \text{ Hz} \leq f_v \leq 1000 \text{ Hz}$.

IV. ACCELERATION SENSITIVITY OF DIFFERENT CLASSES OF OSCILLATORS

Fig. 8 shows the setup used to measure acceleration sensitivity of different microwave oscillators. A direct digital PM noise measurement [16] is used that utilizes fast analog-to-digital converters to digitize the input RF signal and perform down-conversion and phase detection functions by digital signal processing. The oscillator under test is mounted on the actuator, with the output going to one input of a mixer. This output is then mixed with a stationary very-low-PM-noise oscillator to generate a beat frequency between 1 MHz to 30 MHz for digitizing directly. A low-noise 10 MHz quartz crystal oscillator serves nicely as the digitizer's reference.

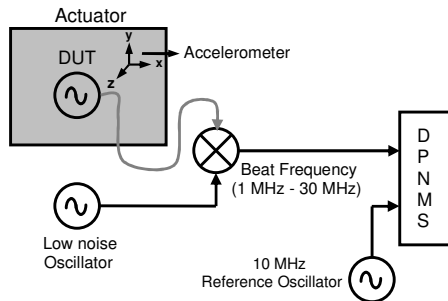

Fig. 8. Block diagram of an experimental setup for measuring acceleration sensitivity of an oscillator. DPNMS – Direct-digital PM noise measurement system.

Fig. 9 shows different types of oscillators chosen for the vibration test, namely, low and high PM noise DROs at 10 GHz, a silicon germanium (SiGe) amplifier-based STW oscillator at 2.5 GHz [17], and a TE_{023} mode air-dielectric ceramic-cavity resonator oscillator (ACCRO) at 10 GHz [18]. A STW oscillator is chosen because this is a very low noise oscillator with a stiff resonator in the frequency range 1 to 3

GHz. Below 1 GHz, surface acoustic wave (SAW) oscillators perform well [19], and above 3 GHz, DROs provide the best compromise between performance and cost. There are several other commercially available oscillators above 3 GHz that have extremely low phase noise, but are large, specialized and expensive by comparison. At first the PM noise of DRO-1, STW and ACCRO is measured without vibration, and then they are subjected to random vibration along the z-axis. Figs. 10 and 11 show the PM noise and z-axis acceleration sensitivity of these oscillators respectively; the acceleration sensitivity of the STW oscillator is two orders of magnitude lower than that of the DRO.

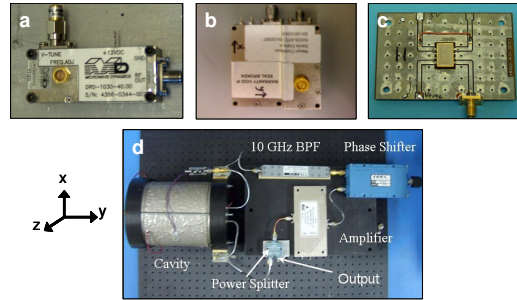

Fig. 9. Pictures of four different types of oscillators used for vibration tests. (a) Dielectric Resonator Oscillator (DRO-1) with high PM noise, (b) DRO-2 with low PM noise, (c) Surface transverse wave (STW) oscillator, (d) Air-dielectric ceramic-cavity resonator oscillator (ACCRO). Arbitrary x and y axes are chosen in the plane of the page, and the z-axis is normal to the device top surface.

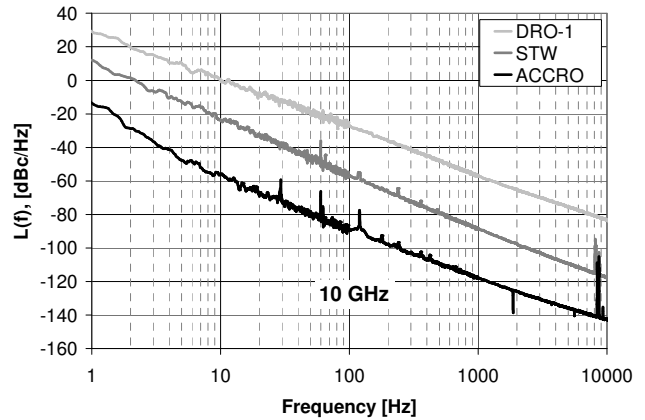

Fig. 10. PM noise of three different oscillators at 10 GHz without vibration. For direct comparison, the PM noise of 2.5 GHz STW oscillator is normalized to 10 GHz.

Further, the acceleration sensitivities of two DROs of comparable size and weight but different PM noise are compared. These DROs at 10 GHz are subjected to a random vibration along three axes independently. For DRO-1, the effect of random vibration in the x and y axes is not noticeable, because the PM noise of the stationary DRO is significantly higher than the noise induced by random vibration. In order to measure the acceleration sensitivity in all three axes, the DRO is subjected to sinusoidal vibration with higher g-levels at different spot frequencies. Figs. 12 and 13 respectively show the PM noise and acceleration sensitivity of these DROs. These results show that a low-noise oscillator at rest is not

necessarily the best choice for certain applications on a vibrating platform.

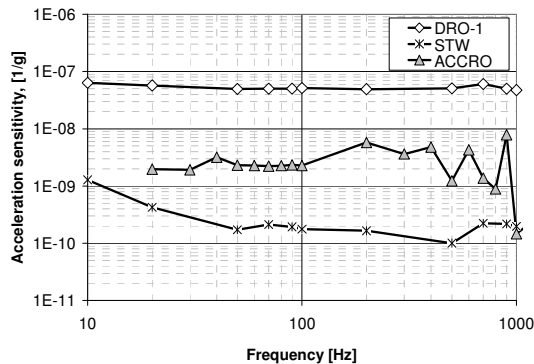

Fig. 11. Comparison of z-axis acceleration sensitivity of different oscillators. A peak acceleration of 1 g is used.

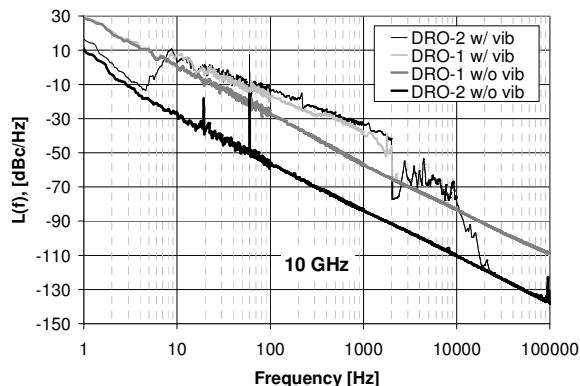

Fig. 12. PM noise of DRO-1 and DRO-2 with and without vibration along the z-axis.

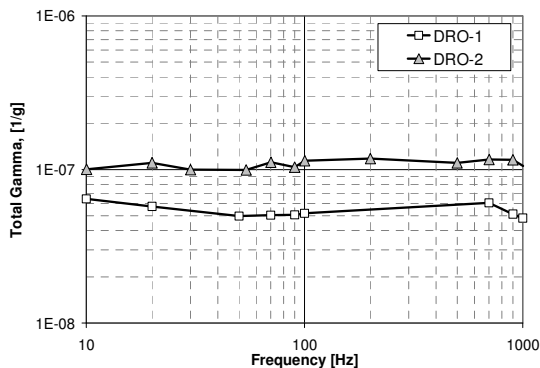

Fig. 13. Plot of total gamma (Γ_{tot}) for the DROs. The lower PM noise oscillator has higher acceleration sensitivity.

V. CONCLUSION

Structure-borne vibration is routine for many applications, causing an increase in PM noise of oscillators that disables or degrades the performance of many systems. Therefore, it is very important to select components that show low phase changes under vibration in order to build a system with low vibration sensitivity. In this paper, the acceleration sensitivity of several components is reported. We find that the coaxial cables that run between the vibrating platform and the stationary measurement system set the PM and AM noise floor. Depending on the cable type, the noise floor can vary anywhere from 10 dB to 30 dB; therefore extra care must be

taken in selecting coaxial cables. Our finding also shows that a low-noise oscillator at rest is not necessarily the best choice for certain applications on a vibrating platform. Vibration also affects the AM noise of nonoscillatory components, and sometimes vibration-induced AM noise can be greater than vibration-induced PM noise. However, for oscillators the effect of vibration on the AM noise is reduced due to signal saturation inside the loop.

REFERENCES

- [1] R. L. Filler, "The acceleration sensitivity of quartz crystal oscillators: A review," *IEEE Trans. Ultrason., Ferroelect., Freq. Contr.*, vol. 35, no. 3, pp. 297-305, May 1988.
- [2] J. R. Vig, C. Audoin, L. S. Cutler, M. M. Driscoll, E. P. EerNisse, R. L. Filler, R. M. Garvey, W. L. Riley, R. C. Smythe, and R. D. Weglein, "Acceleration, vibration and shock effects-IEEE standards project P1193," in *Proc. 46th Annu. Freq. Contr. Symp.*, pp. 763-781, 1992.
- [3] R. L. Filler, J. A. Kosinski, and J. R. Vig, "Further Studies on the Acceleration Sensitivity of Quartz Resonators," in *Proc of 37th Annu. Freq. Contr. Symp.*, pp. 265-271, 1983.
- [4] D. S. Steinberg, *Vibration Analysis for Electronic Equipment*, John Wiley & Sons, Inc. 9780471376859, NY, USA.
- [5] M. M. Driscoll, and J. B. Donovan, "Vibration-Induced Phase Noise: It Isn't Just About the Oscillator," in *Proc. Joint Meeting of EFTF and IEEE FCS*, 2007, pp. 535-540.
- [6] D. B. Leeson, "A simple model of feed back oscillator noise spectrum," in *Proc. IEEE*, vol. 54, no. 2, pp. 329-330, 1966.
- [7] M. Bloch, O. Mancini, and C. Stone, "Method for achieving highly reproducible acceleration insensitive quartz crystal oscillators," *U.S. Patent 07106143*, 2006.
- [8] D. A. Howe, J. Lanfranchi, L. Cutsinger, A. Hati, and C. W. Nelson, "Vibration-induced PM noise in oscillators and measurements of correlation with vibration sensors," in *Proc. IEEE Freq. Contr. Symp.*, 2005, pp. 494-498.
- [9] M. M. Driscoll, "Reduction of Quartz Oscillator flicker-of-frequency and white phase noise (floor) levels of acceleration sensitivity via use of multiple resonators," *IEEE Trans. Ultrason., Ferroelect., Freq. Contr.*, vol. 40, no. 4, pp. 427-430, July 1993.
- [10] H. Freuhauf, "g-Compensated, Miniature, High Performance Quartz Crystal Oscillators," in *Proc. 38th Annual PTTI Meeting*, 2007, pp. 251-258.
- [11] J. A. Kosinski, "Theory and design of crystal oscillators immune to acceleration: Present state of the art," in *Proc. IEEE/EIA Freq. Contr. Symp. and Exhibit.*, 2000, pp. 260-268.
- [12] A. Hati, C. W. Nelson, D. A. Howe, N. Ashby, J. Taylor, K. M. Hudek, C. Hay, D. Seidel and D. Eliyahu, "Vibration Sensitivity of Microwave Components," in *Proc. Joint Meeting of EFTF and IEEE FCS*, 2007, pp. 541-546.
- [13] P. Stockwell, C. McNeilage, M. Mossammaparast, D.M. Green, J.H. Searls, "3-axis vibration performance of a compact sapphire microwave oscillator," in *Proc. IEEE Freq. Contr. Symp and PDA Exhibit.*, 2001, pp. 695-698.
- [14] F. L. Walls, and E. S. Ferre-Pikal, "Measurement of frequency, phase noise and amplitude noise," *Wiley Encyclopedia Electr. & Electron. Engineer.*, vol. 12, pp. 459-473, June 1999.
- [15] E. Rubiola, M. Bruno, G. Lorino and A. De Marchi, "Piezoelectric effect in coaxial cables," in *Proc. 11th EFTF*, 1997, pp. 632-635.
- [16] J. Grove, J. Hein, J. Retta, P. Schweiger, W. Solbrig and S.R. Stein, "Direct-digital phase-noise measurement," in *Proc. IEEE Freq. Contr. Symp.*, 2004, pp. 287-291.
- [17] C. E. Hay, M.E. Harrell and R.J. Kansy, "2.4 and 2.5 GHz miniature, low-noise oscillators using surface transverse wave resonators and a SiGe sustaining amplifier," in *Proc. IEEE Freq. Contr. Symp.*, 2004, pp. 174-179.
- [18] A. Hati, D.A. Howe, and C.W. Nelson, "Comparison of AM noise in commercial amplifiers and oscillators at X-band," in *Proc. IEEE Freq. Contr. Symp.*, 2006, pp. 740-744.
- [19] T. E. Parker, and G.K. Montress, "Precision surface-acoustic-wave (SAW) oscillators," *IEEE Trans. Ultrason., Ferroelect., Freq. Contr.*, vol. 35, no. 3, pp. 342-364, May 1988.